



(51) International Patent Classification:

C07K 14/00 (2006.01) G01N 33/574 (2006.01)  
C40B 30/04 (2006.01) G01N 33/68 (2006.01)  
G01N 33/53 (2006.01)

(21) International Application Number:

PCT/US2017/038392

(22) International Filing Date:

20 June 2017 (20.06.2017)

(25) Filing Language:

English

(26) Publication Language:

English

(30) Priority Data:

62/352,519 20 June 2016 (20.06.2016) US  
62/421,185 11 November 2016 (11.11.2016) US

(71) Applicant: HEALTHTELL INC. [US/US]; 2420 Camino Ramon, Suite 125, San Ramon, California 94583 (US).

(72) Inventors: ROWE, Michael William; c/o HealthTell Inc., 2420 Camino Ramon, Suite 125, Sam Ramon, California 94583 (US). TARASOW, Theodore Michael; c/o HealthTell Inc., 2420 Camino Ramon, Suite 125, San Ra-

mon, California 94583 (US). MELNICK, Jonathan Scott; c/o HealthTell Inc., 2420 Camino Ramon, Suite 125, San Ramon, California 94583 (US).

(74) Agent: WESTIN, Lorelei P.; Wilson Sonsini Goodrich & Rosati, 650 Page Mill Road, Palo Alto, California 94304 (US).

(81) Designated States (unless otherwise indicated, for every kind of national protection available): AE, AG, AL, AM, AO, AT, AU, AZ, BA, BB, BG, BH, BN, BR, BW, BY, BZ, CA, CH, CL, CN, CO, CR, CU, CZ, DE, DJ, DK, DM, DO, DZ, EC, EE, EG, ES, FI, GB, GD, GE, GH, GM, GT, HN, HR, HU, ID, IL, IN, IR, IS, JO, JP, KE, KG, KH, KN, KP, KR, KW, KZ, LA, LC, LK, LR, LS, LU, LY, MA, MD, ME, MG, MK, MN, MW, MX, MY, MZ, NA, NG, NI, NO, NZ, OM, PA, PE, PG, PH, PL, PT, QA, RO, RS, RU, RW, SA, SC, SD, SE, SG, SK, SL, SM, ST, SV, SY, TH, TJ, TM, TN, TR, TT, TZ, UA, UG, US, UZ, VC, VN, ZA, ZM, ZW.

(84) Designated States (unless otherwise indicated, for every kind of regional protection available): ARIPO (BW, GH, GM, KE, LR, LS, MW, MZ, NA, RW, SD, SL, ST, SZ, TZ, UG, ZM, ZW), Eurasian (AM, AZ, BY, KG, KZ, RU, TJ,

(54) Title: METHODS FOR DIAGNOSIS AND TREATMENT OF AUTOIMMUNE DISEASES

FIG. 4

Peptides that Distinguish Active vs. Inactive SLE

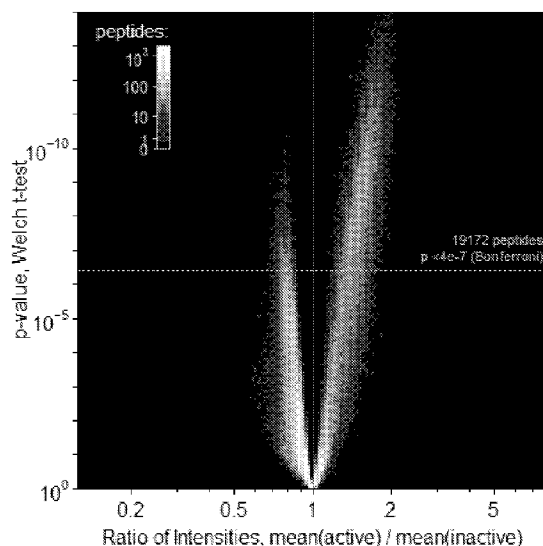

(57) Abstract: Provided herein are methods, assays and devices for the detection and diagnosis of autoimmune diseases, including systemic lupus erythematosus. The methods, assays and devices provided herein analyzes binding patterns of peripheral-blood antibodies on peptide array that correlates well with current systemic lupus erythematosus clinical assessment standards.



TM), European (AL, AT, BE, BG, CH, CY, CZ, DE, DK, EE, ES, FI, FR, GB, GR, HR, HU, IE, IS, IT, LT, LU, LV, MC, MK, MT, NL, NO, PL, PT, RO, RS, SE, SI, SK, SM, TR), OAPI (BF, BJ, CF, CG, CI, CM, GA, GN, GQ, GW, KM, ML, MR, NE, SN, TD, TG).

**Declarations under Rule 4.17:**

- *as to applicant's entitlement to apply for and be granted a patent (Rule 4.17(ii))*
- *as to the applicant's entitlement to claim the priority of the earlier application (Rule 4.17(iii))*

**Published:**

- *with international search report (Art. 21(3))*

**METHODS FOR DIAGNOSIS AND TREATMENT OF AUTOIMMUNE DISEASES****CROSS-REFERENCE**

[0001] This patent application claims the benefit of U.S. Application Serial No. 62/352,519, filed June 20, 2016; and U.S. Application Serial No. 62/421,185, filed November 11, 2016; each of which is incorporated herein by reference in their entirety.

**BACKGROUND OF THE INVENTION**

[0002] Autoimmune disease patients can experience chronically active disease, fluctuating rounds of remission and flare, or long quiescence. Accurately detecting and determining the status of a patient is central to prescribing appropriate drug regimens, evaluating treatment outcomes, defining patient subgroups, and early detection of flare onsets in order to improve therapeutic outcomes of patients afflicted with an autoimmune disease.

**SUMMARY OF THE INVENTION**

[0003] Provided herein are methods, assays and devices for determining or diagnosing immune-mediated disease activity in a subject. Immune mediated disease activity includes but is not limited to autoimmune disease activity, infectious disease activity, cancer activity and diabetes disease activity.

[0004] Accordingly, disclosed herein are methods, assays and devices for determining autoimmune disease activity in a subject, said method comprising: contacting a sample from the subject to a peptide array comprising a plurality of different peptides on distinct features of the array; detecting the binding of antibodies present in the sample to a set of peptides on the peptide array to obtain a pattern of binding signals, wherein the set of peptides are indicative of autoimmune disease activity; and comparing said binding signal to reference binding signals obtained from a plurality of subjects in a reference group having a range of disease activities to determine the presence and/or severity of autoimmune disease activity in said subject.

[0005] In some embodiments, the peptide array comprises at least 10,000 different peptides, at least 50,000 different peptides or at least 100,000 different peptides. In other embodiments, the different peptides on the array are deposited. In still other embodiments, the different peptides on the array are synthesized in situ. In yet other embodiments, the synthesis of peptides in situ comprises less than 20 different amino acids. In some embodiments, cysteine, methionine, isoleucine and threonine are excluded during synthesis of the peptide array.

[0006] In one embodiment, the autoimmune disease comprises systemic lupus erythematosus (SLE), rheumatoid arthritis, Sjogren's disease, multiple sclerosis, ulcerative colitis, psoriatic arthritis, scleroderma and/or type I diabetes. In other embodiments, the autoimmune disease is systemic lupus erythematosus (SLE). In other embodiments, the binding signal of a set of

peptides indicative of SLE in the reference samples are higher in subjects from the reference group having a score of at least 12 when using SLEDAI or SLEDAI-SELENA scoring system. In still other embodiments, the binding signal of a set of peptides indicative of SLE in the reference samples are lower in subjects from the reference having a score of less than 2 when using SLEDAI or SLEDAI-SELENA scoring system. In one embodiment, the binding signal of a set of peptides indicative of SLE in the reference samples are lower in subjects from the reference group having a score of at least 12 when using SLEDAI or SLEDAI-SELENA scoring system. In another embodiment, the binding signal of a set of peptides indicative of SLE in the reference samples are lower in subjects from the reference group having a score of less than 2 when using SLEDAI or SLEDAI-SELENA scoring system. In another embodiment, the set of peptides indicative of SLE in the reference samples are enriched by greater than 100% in one or more sequence motifs or amino acids listed in Figures 13A-13G. In still other embodiments, the average binding signal of the set of peptides indicative of an autoimmune disorder in the reference samples is lower in subjects from said reference group having high disease activity than the average binding signal of said peptides from subjects in said reference group having higher disease activity.

**[0007]** In still other embodiments, the set of peptides indicative of SLE are enriched by at least 150% in at least one or more amino acids as compared to the remaining peptides in the peptide array. In yet other embodiments, the set of peptides comprises at least 10 peptides, at least 20 peptides, at least 30 peptides, at least 40 peptides, at least 50 peptides, at least 60 peptides, at least 70 peptides, at least 80 peptides, at least 90 peptides or at least 100 peptides are indicative of autoimmune disease activity. In one embodiment, the pattern of binding signals obtained classifies said autoimmune disease activity selected from low disease activity, moderate disease activity, and severe disease activity. In another embodiment, a calculated area under the receiver operator characteristic (ROC) curve (AUC) ranging from 0.60 to 0.70, 0.70 to 0.79, 0.80 to 0.89, or 0.90 to 1.0 determines the presence and/or severity of autoimmune disease activity in said subject.

**[0008]** In yet other embodiments, a range of disease activities is determined by the presence of one or more clinical conditions comprising high anti-dsDNA antibodies, low complement protein C3, low complement protein C4, high antinuclear antibody (ANA), high proteinuria, malar rash, CNS manifestation, arthritis, cytopenia, discoid rash, oral ulcers, renal manifestation, immunologic, photosensitivity, and serositis. In some embodiments, a range of disease activities is further determined by the presence of one or more clinical conditions comprising high anti-dsDNA antibodies, low complement protein C3, low complement protein C4, high antinuclear antibody (ANA), high proteinuria, malar rash, CNS manifestation, arthritis, cytopenia, discoid

rash, oral ulcers, renal manifestation, immunologic, photosensitivity, and serositis. In still other embodiments, a range of disease activities is further determined by the presence of a known biomarker of one or more clinical conditions.

**[0009]** In one embodiment, the subject is human. In another embodiment, the sample is a blood sample. In other embodiments, the blood sample is selected from whole blood, plasma, or serum. In one embodiment, the sample is a serum sample. In still other embodiments, the sample is a plasma sample. In yet other embodiments, the sample is a dried blood sample. In still other embodiments, the at least 10,000 different peptides on the peptide array are at least 5 amino acids in length. In other embodiments, the at least 10,000 different peptides on the peptide array are at least between 5 and 15 amino acids in length. In another embodiment, the at least 10,000 different peptides are synthesized from less than 20 amino acids. In other embodiments, the at least 10,000 different peptides on the peptide array are synthesized by excluding one or more of cysteine, methionine, isoleucine and threonine.

**[0010]** Also disclosed herein are immunosignatures of a subject indicative of an autoimmune disorder obtained from a sample, wherein the immunosignature comprises a binding pattern from a set of peptides on a peptide array comprising at least 10,000 peptides. In some embodiments, the immunosignature comprises an enrichment of at least one amino acid in the set of peptides by at least 150%, as compared to remaining peptides on the peptide array. In other embodiments, the peptide array comprises at least 5,000 different peptides, at least 50,000 different peptides, at least 100,000 different peptides, at least 250,000 peptides, at least 330,000 peptides. In other embodiments, the at least 10,000 different peptides on the peptide array is between 5 and 15 amino acids in length.

**[0011]** Also disclosed herein are systems for determining autoimmune disease activity in a subject, the system comprising: (a) an array of peptides comprising at least 10,000 different peptides synthesized in situ, wherein a sample from a subject is contacted to the array; (b) a detector for detecting the binding of antibodies present in said sample to a set of peptides on said array to obtain a combination of binding signals; and (c) a digital processing device for analyzing and comparing said combination of binding signals to one or more groups of combinations of reference binding signals, wherein each of said groups of combinations of reference binding signals comprises a combination of binding signals obtained from a plurality of healthy subjects, thereby determining whether the subject has an autoimmune disease. In some embodiments, the autoimmune disease is SLE.

## INCORPORATION BY REFERENCE

[0012] All publications, patents, and patent applications mentioned in this specification are herein incorporated by reference to the same extent as if each individual publication, patent, or patent application was specifically and individually indicated to be incorporated by reference.

## BRIEF DESCRIPTION OF THE DRAWINGS

[0013] The patent or application file contains at least one drawing executed in color. Copies of this patent or patent application publication with color drawing(s) will be provided by the Office upon request and payment of the necessary fee.

[0014] The novel features of the invention are set forth with particularity in the appended claims. A better understanding of the features and advantages of the present invention will be obtained by reference to the following detailed description that sets forth illustrative embodiments, in which the principles of the invention are utilized, and the accompanying drawings in the following.

[0015] **FIG. 1A** shows a SLEDAI Score Sheet of clinical and laboratory manifestations used to assess systemic lupus erythematosus diagnosis and assessment.

[0016] **FIG. 1B** shows a continuation of a SLEDAI Score Sheet of clinical and laboratory manifestations used to assess systemic lupus erythematosus diagnosis and assessment.

[0017] **FIG. 2** shows a summary of the SLE patients in the study.

[0018] **FIG. 3** is a pathway showing how a self protein/antigen can lead to up-regulation and down-regulation of an immunosignature in peptide microarrays.

[0019] **FIG. 4** is a volcano plot of peptides distinguishing active SLE disease versus inactive SLE disease.

[0020] **FIG. 5** are Receiver-Operator Characteristic (ROC) curves for an immunosignature (IMS) model of disease activity as compared to variety of biomarkers as (anti-dsDNA, UPCR (urine protein/creatinine ratio) and C3 protein) set forth in the SLEDAI index.

[0021] **FIG. 6** illustrates a heat map of the top 702 peptides based on t-test p-values between SLE subjects.

[0022] **FIG. 7** shows the immunosignature (IMS) peptides that map to known and putative SLE antigens.

[0023] **FIG. 8** shows the cross-validated SVM classifier predictions of a subject, demonstrating that higher SLE activity is easily distinguished from remission.

[0024] **FIG. 9** shows a comparison of predictive capacity of IMS models against known biomarkers anti-dsDNA, C3, C4 and UPCR. The data exemplifies that immunosignature models can estimate SLEDAI scores as well or better than these standard biomarkers.

[0025] FIG. 10 shows a plot of measured changes in binding in order to monitor a patient's disease state and level of activity. This was done by fitting an elastic net model of changes in SLEDAI score against the peptide intensities obtained in the discriminating peptides. The data support that changes in antibody binding are more closely related to changes in SLEDAI than changes in other biomarkers.

[0026] FIG. 11 shows the improvement in predicting lupus and correlating to SLEDAI changes when immunosignature is combined with a biomarker assay.

[0027] FIG. 12 further demonstrates the difference in immune response that increases with increasing SLEDAI scores, as compared to remission.

[0028] FIG. 13A-13G shows the peptide motifs and amino acids that are enriched in the peptides that correlate to a diagnosis from a SLEDAI score.

### DETAILED DESCRIPTION OF THE INVENTION

[0029] Detecting and diagnosing immune-mediated disorders, such as autoimmune disorders, is challenging, with patients having a difficult time receiving an accurate or correct diagnosis. Autoimmune diseases remains a major cause of morbidity and mortality. In many instances, patients are often misdiagnosed with other autoimmune conditions because of the closely related nature of these diseases. There are currently no reliable bio-markers available for the detection and assessment of autoimmune diseases or disorders. Prompt treatment, for example of flares related to systemic lupus erythematosus, not results in better immediate outcomes, but will prevent cumulative chronic organ damage. Accordingly, sensitive and specific diagnosis of disease activity remains an important unmet clinical need. *See* Oglesby et al, Impact of early versus late systemic lupus erythematosus diagnosis on clinical and economic outcomes. *Applied Health Economics & Health Policy*. 12(2):179-90, 2014; Lisnevskaja et al, Systemic lupus erythematosus. *Lancet*. 384(9957):1878-88, 2014.

[0030] A common approach instead for clinical studies is the use of scoring systems to evaluate physiological and biochemical manifestations of the autoimmune condition in subjects. For example, the most commonly used study of lupus activity for clinical subjects is the Systemic Lupus Erythematosus Disease Activity Index (SLEDAI). SLEDAI is a list of 24 clinical manifestations and laboratory tests, such as seizure, psychosis, organic brain syndrome, visual disturbance, other neurological problems, hair loss, new rash, muscle weakness, arthritis, blood vessel inflammation, mouth sores, chest pain worsening with deep breathing and manifestations of pleurisy and/or pericarditis and fever. The laboratory results analyzed include urinalysis testing, blood complement levels, increased anti-DNA antibody levels, low platelets and low

white blood cell count. Each item is scored based on whether these manifestations have been present or absent in the patient in the previous 10 days. *See* FIG. 1A and FIG. 1B.

**[0031]** The SLEDAI index requires weighting of the different clinical and laboratory test categories, including organ involvement. For example, joint pain and kidney disease are each multiplied by four, but central nervous system neurological manifestations are multiplied by eight. The assigned weighted assessment is then summed up into a final score, which ranges from zero to 105, with scores greater than 20 being unusual or rare. However, while there is no consensus on how to classify these scores, a SLEDAI score of 6 or more has been shown to be consistent with active disease requiring therapy, while a score below 3 is generally considered to be inactive. Scores of 4 to 15 are indicative of mild or moderate disease, and those greater than 15 are considered to be severe. A clinically meaningful difference has been reported to be an improvement of 6 points or worsening of 8 points.

**[0032]** The SLEDAI assessment was modified in the Safety of Estrogens in Lupus Erythematosus National Assessment (SELENA) trial, also known as the SELENA-SLEDAI flare index. While the SELENA-SLEDAI offers some clarification with regards to the definitions of clinical activity in each item, the basic premise and scoring system developed and characterized in the SLEDAI analysis has not changed significantly.

**[0033]** Yet other clinical assessment instruments for assessing systemic lupus erythematosus includes the BILAG (British Isles Lupus Activity Group), which is an 86 question physician's assessment of specific organ function, including a compilation of multiple manifestations and laboratory tests combined into a single score for a given organ system. In addition, other diseases or disorders have similar correlative assays which can also be used to establish or grade disease activity, including DAS28 (Disease Activity Score) for rheumatoid arthritis, TNM (Tumor, Node, Metastasis) staging system for cancer disorders, the Nottingham grading system (also known as the Elston-Ellis modification of the Scarff-Bloom-Richardson grading system), the Gleason scoring system for the prognosis and diagnosis of prostate cancer, amongst others.

**[0034]** Because of its complexity, disease scoring systems, such as SLEDAI, BILAG, and other correlative tests, are most commonly applied in research or clinical trials to evaluate the effectiveness of new drugs. It is, however, impractical for routine use by clinicians (for example, Rheumatologists). A simple, accurate, molecular test is needed to improve patient care.

**[0035]** Disclosed herein are methods, assays and devices that identify differential patterns of peripheral-blood antibody binding to a peptide array. Differential binding of patient samples to the array results in specific binding patterns or signatures indicative of the disease state of the patient. These binding signatures can accurately determine or diagnose a disease activity,

including but not limited to autoimmune disease activity, infectious disease activity, cancer activity, and diabetes disease activity. For example, the methods and devices disclosed herein can identify or determine an SLE patient's disease status, correlating with clinical assessment outcomes, such as SLEDAI or BILAG.

**[0036]** The differential binding activity or signatures, also referred to as “immunosignatures”, obtained by the methods, devices and assays disclosed herein also correlate with known disease scoring systems. For example, the immunosignature binding patterns obtained with the methods and arrays disclosed have an area under the receiver operator characteristic (ROC) curve (AUC) of at least 0.6, at least 0.65, at least 0.7, at least 0.75, at least 0.8, at least 0.85, at least 0.9, at least 0.95, at least 0.97, at least 0.99 or at least 1.0 when compared to patients analyzed and diagnosed with an immune-mediated disorder when compared to a known immune-mediated disease scoring system, including, for example, SLEDAI, SELENA-SLEDAI, BILAG, DAS28, TNM, the Nottingham grading system and/or the Gleason scoring system. In preferred embodiments, the known immune-mediated disease scoring system is SLEDAI or SELENA-SLEDAI. The immunosignature binding pattern identified may include, but is not limited to, a peptide sequence, a peptide motif, amino acid content or other distinguishing feature of the immunosignature binding patterns detected.

**[0037]** As disclosed herein, the AUC may be interpreted as the probability that a patient with active disease according to the known scoring system would have a higher value associated with the immunosignatures binding pattern than a patient with inactive disease according to the known scoring system.

**[0038]** In other embodiments, the immunosignature binding patterns for SLE patients obtained with the methods and arrays disclosed have an area under the receiver operator characteristic (ROC) curve (AUC) of at least 0.6, at least 0.65, at least 0.7, at least 0.75, at least 0.8, at least 0.85, at least 0.9, at least 0.95, at least 0.97, at least 0.99 or at least 1.0 when compared to patients analyzed and diagnosed with an autoimmune disorder when compared to a known autoimmune disease scoring system, including, for example, SLEDAI, SELENA-SLEDAI, BILAG, DAS28 or other clinical autoimmune disease scoring systems.

**[0039]** In further embodiments, the immunosignature binding patterns for SLE patients obtained with the methods and arrays disclosed have an area under the receiver operator characteristic (ROC) curve (AUC) of at least 0.6, at least 0.65, at least 0.7, at least 0.75, at least 0.8, at least 0.85, at least 0.9, at least 0.95, at least 0.97, at least 0.99 or at least 1.0 when compared to patients scoring lower than 2 using the SLEDAI or SELENA-SLEDAI scoring system.

**[0040]** In further embodiments, the immunosignature binding patterns for SLE patients obtained with the methods and arrays disclosed have an area under the receiver operator characteristic

(ROC) curve (AUC) of at least 0.6, at least 0.65, at least 0.7, at least 0.75, at least 0.8, at least 0.85, at least 0.9, at least 0.95, at least 0.97, at least 0.99 or at least 1.0 when compared to patients scoring between 2 and 8 using the SLEDAI or SELENA-SLEDAI scoring system.

**[0041]** In further embodiments, the immunosignature binding patterns for SLE patients obtained with the methods and arrays disclosed have an area under the receiver operator characteristic (ROC) curve (AUC) of at least 0.6, at least 0.65, at least 0.7, at least 0.75, at least 0.8, at least 0.85, at least 0.9, at least 0.95, at least 0.97, at least 0.99 or at least 1.0 when compared to patients scoring at least 12 using the SLEDAI or SELENA-SLEDAI scoring system.

**[0042]** In yet further embodiments, at least 0.00005%, at least .0001%, at least .0005%, at least .0001%, at least .005%, at least .01%, at least .05%, at least 0.1%, at least 0.5%, at least 1.0%, at least 1.5%, at least 2%, at least 3%, at least 4%, at least 5% or at least 10% of the peptides comprising the immunosignature binding patterns obtained with the methods and arrays disclosed have an area under the receiver operator characteristic (ROC) curve (AUC) of at least 0.6, at least 0.65, at least 0.7, at least 0.75, at least 0.8, at least 0.85, at least 0.9, at least 0.95, at least 0.97, at least 0.99 or at least 1.0 when compared to patients analyzed and diagnosed with an immune-mediated disorder using a known immune-mediated disease scoring system, including, for example, SLEDAI, SELENA-SLEDAI, BILAG, DAS28, TNM, the Nottingham grading system and/or the Gleason scoring system. In preferred embodiments, the known immune-mediated disease scoring system is SLEDAI or SELENA-SLEDAI.

**[0043]** In yet further embodiments, at least 0.00005%, at least .0001%, at least .0005%, at least .0001%, at least .005%, at least .01%, at least .05%, at least 0.1%, at least 0.5%, at least 1.0%, at least 1.5%, at least 2%, at least 3%, at least 4%, at least 5% or at least 10% of the peptides comprising the immunosignature binding patterns obtained with the methods and arrays disclosed have an area under the receiver operator characteristic (ROC) curve (AUC) of at least 0.6, at least 0.65, at least 0.7, at least 0.75, at least 0.8, at least 0.85, at least 0.9, at least 0.95, at least 0.97, at least 0.99 or at least 1.0 when compared to SLE patients analyzed and diagnosed with a scoring lower than 2 using the SLEDAI or SELENA-SLEDAI scoring system.

**[0044]** In yet further embodiments, at least 0.00005%, at least .0001%, at least .0005%, at least .0001%, at least .005%, at least .01%, at least .05%, at least 0.1%, at least 0.5%, at least 1.0%, at least 1.5%, at least 2%, at least 3%, at least 4%, at least 5% or at least 10% of the peptides comprising the immunosignature binding patterns obtained with the methods and arrays disclosed have an area under the receiver operator characteristic (ROC) curve (AUC) of at least 0.6, at least 0.65, at least 0.7, at least 0.75, at least 0.8, at least 0.85, at least 0.9, at least 0.95, at least 0.97, at least 0.99 or at least 1.0 when compared to SLE patients analyzed and diagnosed with a scoring between 2 and 8 using the SLEDAI or SELENA-SLEDAI scoring system.

**[0045]** In yet further embodiments, at least 0.00005%, at least .0001%, at least .0005%, at least .0001%, at least .005%, at least .01%, at least .05%, at least 0.1%, at least 0.5%, at least 1.0%, at least 1.5%, at least 2%, at least 3%, at least 4%, at least 5% or at least 10% of the peptides comprising the immunosignature binding patterns obtained with the methods and arrays disclosed have an area under the receiver operator characteristic (ROC) curve (AUC) of at least 0.6, at least 0.65, at least 0.7, at least 0.75, at least 0.8, at least 0.85, at least 0.9, at least 0.95, at least 0.97, at least 0.99 or at least 1.0 when compared to SLE patients analyzed and diagnosed with a scoring of at least 12 using the SLEDAI or SELENA-SLEDAI scoring system.

**[0046]** In yet further embodiments, at least 1 peptide, at least 2 peptides, at least 3 peptides, at least 4 peptides, at least 5 peptides, at least 6 peptides, at least 7 peptides, at least 8 peptides, at least 9 peptides, at least 10 peptides, at least 15 peptides, at least 20 peptides, at least 25 peptides, at least 30 peptides, at least 35 peptides, at least 40 peptides, at least 45 peptides, at least 50 peptides, at least 55 peptides, at least 60 peptides, at least 65 peptides, at least 70 peptides, at least 75 peptides, at least 80 peptides, at least 85 peptides, at least 90 peptides, at least 95 peptides or at least 100 peptides of the immunosignature binding patterns obtained with the methods and arrays disclosed have an area under the receiver operator characteristic (ROC) curve (AUC) of at least 0.6, at least 0.65, at least 0.7, at least 0.75, at least 0.8, at least 0.85, at least 0.9, at least 0.95, at least 0.97, at least 0.99 or at least 1.0 when compared to patients analyzed and diagnosed with an immune-mediated disorder using a known immune-mediated disease scoring system, including, for example, SLEDAI, SELENA-SLEDAI, BILAG, DAS28, TNM, the Nottingham grading system and/or the Gleason scoring system. In preferred embodiments, the known immune-mediated disease scoring system is SLEDAI or SELENA-SLEDAI.

**[0047]** In yet further embodiments, at least 1 peptide, at least 2 peptides, at least 3 peptides, at least 4 peptides, at least 5 peptides, at least 6 peptides, at least 7 peptides, at least 8 peptides, at least 9 peptides, at least 10 peptides, at least 15 peptides, at least 20 peptides, at least 25 peptides, at least 30 peptides, at least 35 peptides, at least 40 peptides, at least 45 peptides, at least 50 peptides, at least 55 peptides, at least 60 peptides, at least 65 peptides, at least 70 peptides, at least 75 peptides, at least 80 peptides, at least 85 peptides, at least 90 peptides, at least 95 peptides or at least 100 peptides of the immunosignature binding patterns obtained with the methods and arrays disclosed have an area under the receiver operator characteristic (ROC) curve (AUC) of at least 0.6, at least 0.65, at least 0.7, at least 0.75, at least 0.8, at least 0.85, at least 0.9, at least 0.95, at least 0.97, at least 0.99 or at least 1.0 when compared to SLE patients analyzed and diagnosed with a scoring lower than 2 using the SLEDAI or SELENA-SLEDAI scoring system.

**[0048]** In yet further embodiments, at least 1 peptide, at least 2 peptides, at least 3 peptides, at least 4 peptides, at least 5 peptides, at least 6 peptides, at least 7 peptides, at least 8 peptides, at least 9 peptides, at least 10 peptides, at least 15 peptides, at least 20 peptides, at least 25 peptides, at least 30 peptides, at least 35 peptides, at least 40 peptides, at least 45 peptides, at least 50 peptides, at least 55 peptides, at least 60 peptides, at least 65 peptides, at least 70 peptides, at least 75 peptides, at least 80 peptides, at least 85 peptides, at least 90 peptides, at least 95 peptides or at least 100 peptides of the immunosignature binding patterns obtained with the methods and arrays disclosed have an area under the receiver operator characteristic (ROC) curve (AUC) of at least 0.6, at least 0.65, at least 0.7, at least 0.75, at least 0.8, at least 0.85, at least 0.9, at least 0.95, at least 0.97, at least 0.99 or at least 1.0 when compared to SLE patients analyzed and diagnosed with a scoring between 2 and 8 using the SLEDAI or SELENA-SLEDAI scoring system.

**[0049]** In yet further embodiments, at least 1 peptide, at least 2 peptides, at least 3 peptides, at least 4 peptides, at least 5 peptides, at least 6 peptides, at least 7 peptides, at least 8 peptides, at least 9 peptides, at least 10 peptides, at least 15 peptides, at least 20 peptides, at least 25 peptides, at least 30 peptides, at least 35 peptides, at least 40 peptides, at least 45 peptides, at least 50 peptides, at least 55 peptides, at least 60 peptides, at least 65 peptides, at least 70 peptides, at least 75 peptides, at least 80 peptides, at least 85 peptides, at least 90 peptides, at least 95 peptides or at least 100 peptides of the immunosignature binding patterns obtained with the methods and arrays disclosed have an area under the receiver operator characteristic (ROC) curve (AUC) of at least 0.6, at least 0.65, at least 0.7, at least 0.75, at least 0.8, at least 0.85, at least 0.9, at least 0.95, at least 0.97, at least 0.99 or at least 1.0 when compared to SLE patients analyzed and diagnosed with a scoring of at least 12 using the SLEDAI or SELENA-SLEDAI scoring system.

**[0050]** In some embodiments, the immunosignature binding patterns obtained with the methods and arrays disclosed herein correlate with at least 50%, at least 55%, at least 60%, at least 65%, at least 70%, at least 75%, at least 80%, at least 85%, at least 90%, at least 95%, at least 96%, at least 97%, at least 98% or at least 99% of patients analyzed and diagnosed with an immune-mediated disorder when compared to patients analyzed using a known immune-mediated disease scoring system, including, for example, SLEDAI, SELENA-SLEDAI, BILAG, DAS28, TNM, the Nottingham grading system and/or the Gleason scoring system. In preferred embodiments, the known immune-mediated disease scoring system is SLEDAI or SELENA-SLEDAI.

**[0051]** In other embodiments, the immunosignature binding patterns for diagnosing or detecting autoimmune disorder in a patient obtained with the methods and arrays disclosed herein correlate with at least 50%, at least 55%, at least 60%, at least 65%, at least 70%, at least 75%,

at least 80%, at least 85%, at least 90%, at least 95%, at least 96%, at least 97%, at least 98% or at least 99% of patients analyzed and diagnosed with an autoimmune disorder using an autoimmune disorder scoring system, such as the SLEDAI, SELENA-SLEDAI, DAS28 or BILAG scoring system.

**[0052]** In other embodiments, the immunosignature binding patterns for diagnosing or detecting SLE in a patient obtained with the methods and arrays disclosed herein correlate with at least 50%, at least 55%, at least 60%, at least 65%, at least 70%, at least 75%, at least 80%, at least 85%, at least 90%, at least 95%, at least 96%, at least 97%, at least 98% or at least 99% of patients analyzed and diagnosed with SLE when compared to patients scoring lower than 2 using the SLEDAI or SELENA-SLEDAI scoring system.

**[0053]** In other embodiments, the immunosignature binding patterns for diagnosing or detecting SLE in a patient obtained with the methods and arrays disclosed herein correlate with at least 50%, at least 55%, at least 60%, at least 65%, at least 70%, at least 75%, at least 80%, at least 85%, at least 90%, at least 95%, at least 96%, at least 97%, at least 98% or at least 99% of patients analyzed and diagnosed with SLE when compared to patients scoring between 2 and 12 using the SLEDAI or SELENA-SLEDAI scoring system.

**[0054]** In other embodiments, the immunosignature binding patterns for diagnosing or detecting SLE in a patient obtained with the methods and arrays disclosed herein correlate with at least 50%, at least 55%, at least 60%, at least 65%, at least 70%, at least 75%, at least 80%, at least 85%, at least 90%, at least 95%, at least 96%, at least 97%, at least 98% or at least 99% of patients analyzed and diagnosed with SLE when compared to patients scoring at least 12 using the SLEDAI or SELENA-SLEDAI scoring system.

**[0055]** In yet other embodiments, the immunosignature binding signals for diagnosing or detecting SLE in a patient obtained with the methods and arrays disclosed herein are higher when compared to patients scoring less than 2 using the SLEDAI or SELENA-SLEDAI scoring system. In yet other embodiments, the immunosignature binding signals for diagnosing or detecting SLE in a patient obtained with the methods and arrays disclosed herein are lower when compared to patients scoring less than 2 using the SLEDAI or SELENA-SLEDAI scoring system.

**[0056]** In yet other embodiments, the immunosignature binding signals for diagnosing or detecting SLE in a patient obtained with the methods and arrays disclosed herein are higher when compared to patients scoring between 2 and 8 using the SLEDAI or SELENA-SLEDAI scoring system. In yet other embodiments, the immunosignature binding signals for diagnosing or detecting SLE in a patient obtained with the methods and arrays disclosed herein are lower

when compared to patients scoring between 2 and 8 using the SLEDAI or SELENA-SLEDAI scoring system.

**[0057]** In yet other embodiments, the immunosignature binding signals for diagnosing or detecting SLE in a patient obtained with the methods and arrays disclosed herein are higher when compared to patients scoring at least 12 using the SLEDAI or SELENA-SLEDAI scoring system. In yet other embodiments, the immunosignature binding signals for diagnosing or detecting SLE in a patient obtained with the methods and arrays disclosed herein are lower when compared to patients scoring at least 12 using the SLEDAI or SELENA-SLEDAI scoring system.

**[0058]** In still other embodiments, the immunosignature binding patterns for diagnosing or detecting an immune-mediated disease in a patient obtained with the methods and arrays disclosed herein are enriched by at least 100%, at least 125%, at least 150%, at least 175%, at least 200%, at least 225%, at least 250%, at least 275%, at least 300%, at least 350%, at least 400%, at least 450% or at least 500% in at least one amino acid for the peptides comprising the immunosignature for the immune-mediated disease.

**[0059]** Enriched motifs were identified from the list of significant peptides unless that list was less than 100 peptides long, in which case the top 500 peptides based on the p-value associated with a Welch's t-test were used. The different n-mers in this list of peptides was compared to the same sized n-mers in the total library to determine if any were enriched. Fold enrichment is calculated by determining the number of times a motif (e.g. ABCD) occurs in the list divided by the number of times the motif (ABCD) occurs in the library. This value is further divided by the relative number of times the motif type (e.g., tetramers) appears in the library (*i.e.*, total number of all tetramers in the list divided by the total number of tetramers in the library). The Enrichment (E) calculation can be represented by:

$$E=(m/M)/(t/T)$$

where m is the number of times the motif occurs as part of the discriminating peptide list; M is the total number of times the motif occurs in the library; t is the number of times the motif type appears in the list; and T is the number of times the motif occurs in the library. Fold enrichment can also be reported as Percent enrichment, *i.e.*, "Enrichment value" multiplied by 100.

**[0060]** In yet other embodiments, the immunosignature binding patterns for diagnosing or detecting an autoimmune disease in a patient obtained with the methods and arrays disclosed herein are enriched by at least 100%, at least 125%, at least 150%, at least 175%, at least 200%, at least 225%, at least 250%, at least 275%, at least 300%, at least 350%, at least 400%, at least 450% or at least 500% in at least one amino acid for the peptides comprising the

immunosignature for the autoimmune disease or disorder. In preferred embodiments, the autoimmune disorder is SLE.

**[0061]** In yet other embodiments, the immunosignature binding patterns for diagnosing or detecting SLE in a patient obtained with the methods and arrays disclosed herein are enriched by at least 100%, at least 125%, at least 150%, at least 175%, at least 200%, at least 225%, at least 250%, at least 275%, at least 300%, at least 350%, at least 400%, at least 450% or at least 500% in at least one amino acid for the peptides comprising the immunosignature for detecting or diagnosing SLE.

**[0062]** In some embodiments, the immunosignature binding patterns for diagnosing or detecting an autoimmune disease in a patient obtained with the methods and arrays disclosed herein comprises at least 1, at least 2, at least 3, at least 4, at least 5, at least 6, at least 7, at least 8, at least 9 or at least 10 peptide motifs. In some embodiments, the motifs are at least 25% identical, at least 30% identical, at least 40% identical, at least 50% identical, at least 60% identical, at least 70% identical, at least 80% identical, at least 90% identical, at least 95% identical or at least 99% identical to peptides on the peptide array. In other embodiments, the motifs are at least 25% similar, at least 30% similar, at least 40% similar, at least 50% similar, at least 60% similar, at least 70% similar, at least 80% similar, at least 90% similar, at least 95% similar or at least 99% similar to peptides on the peptide array. In still other embodiments, the motifs for diagnosing or detecting in an autoimmune disease in a patient is at least one of the motifs or amino acids listed in **Figures 13A-13G**.

#### Treatments and Conditions

**[0063]** The methods and arrays of the invention provide methods, assays and devices for the detection and diagnosis of an autoimmune disorder. The methods and arrays of the embodiments disclosed herein can be used, for example, for screening of an immune disorder in a subject. A subject can be a human, a guinea pig, a dog, a cat, a horse, a mouse, a rabbit, and various other animals. A subject can be of any age, for example, a subject can be an infant, a toddler, a child, a pre-adolescent, an adolescent, an adult, or an elderly individual.

**[0064]** A condition of a subject can correspond to a disease or a healthy condition. In some embodiments, a condition of a subject is a healthy condition, and a method of the invention monitors the healthy condition. In some embodiments, a condition of a subject is a disease condition, and a method of the invention is used to diagnose/monitor a state and/or the progression of the condition. A method of the invention can also be used in the prevention of a condition. In some embodiments, a method of the invention is used in conjunction with a prophylactic treatment.

**[0065]** In some embodiments, a method of the invention is a method of diagnosing or determining the presence or absence of an autoimmune disorder in a subject, the method comprising: a. contacting a peptide array with a first biological sample from an individual patient or subject; b. detecting binding of antibodies in the first biological sample with the peptide array to obtain a first immunosignature profile; c. contacting a peptide array with a control sample derived from an individual with a known autoimmune disorder; d. detecting binding of antibody in the control sample with the peptide array to obtain a second immunosignature profile; e. comparing the first immunosignature profile to the second immunosignature profile to determine if a patient or subject has an autoimmune disease or disorder.

**[0066]** In yet other embodiments, a method of the invention is a method of determining the disease state or progression of an autoimmune disorder in a subject, the method comprising: a. contacting a peptide array with a first biological sample from an individual patient or subject with a known autoimmune disorder; b. detecting binding of antibodies in the first biological sample with the peptide array to obtain a first immunosignature profile; c. contacting a peptide array with a control sample derived from an individual with a known stage of an autoimmune disorder; d. detecting binding of antibody in the control sample with the peptide array to obtain a second immunosignature profile; e. comparing the first immunosignature profile to the second immunosignature profile to determine a disease stage or progression of a patient or subject with the autoimmune disease or disorder.

**[0067]** In some embodiments, the immunosignature may be used to augment or improve known biomarker analysis. For example, in systemic lupus erythematosus (SLE), the biomarker may be anti-dsDNA antibodies, complement protein C3, complement protein C4, antinuclear antibody (ANA), proteinuria, malar rash, CNS manifestation, arthritis, cytopenia, discoid rash, oral ulcers, renal manifestation, immunologic, photosensitivity, serositis or combinations thereof. In some instances, the immunosignature may improve sensitivity and specificity of biomarker diagnoses or analyses. In other instances, the immunosignature may improve the accuracy of biomarker diagnoses or analyses. In yet other instances, the immunosignature may improve the assay performance by at least 10%, 20%, 30%, 40%, 50%, 60%, 70%, 80%, 90% or 99% of at assay or diagnostic kit using at least one biomarker.

**[0068]** An array and a method of the invention can be used to, for example, diagnose or detect if a patient or subject is afflicted with an autoimmune disease or disorder. Non-limiting examples of autoimmune diseases or disorders that can be diagnosed, monitored, prevented, and/or treated with an array and a method of the invention can include: systemic lupus erythematosus (SLE),

rheumatoid arthritis, Sjogren's disease, multiple sclerosis, ulcerative colitis, psoriatic arthritis, scleroderma and/or type I diabetes.

**[0069]** In some embodiments, a method of the invention is a method for diagnosing or detecting an autoimmune disorder, the method comprising: a) contacting a peptide array with a first biological sample from a patient or subject; b) detecting binding of antibodies in the first biological sample with the peptide array to obtain a first immunosignature profile; c) contacting a peptide array with a control sample derived from an individual with a known autoimmune disease or disorder; d) detecting binding of antibody in the control sample with the peptide array to obtain a second immunosignature profile; e) comparing the first immunosignature profile to the second immunosignature profile and identifying differentially bound peptides that either bind less or more antibody in the first immunosignature profile as compared to the second immunosignature profile; and f) determining if the patient or subject has an autoimmune disease or disorder.

**[0070]** In some embodiments, a method of the invention is a method for determining the disease state or progression of an autoimmune disorder, the method comprising: a) contacting a peptide array with a first biological sample from a patient or subject with an autoimmune disease or disorder; b) detecting binding of antibodies in the first biological sample with the peptide array to obtain a first immunosignature profile; c) contacting a peptide array with a control sample derived from an individual with a known stage or state of an autoimmune disease or disorder; d) detecting binding of antibody in the control sample with the peptide array to obtain a second immunosignature profile; e) comparing the first immunosignature profile to the second immunosignature profile and identifying differentially bound peptides that either bind less or more antibody in the first immunosignature profile as compared to the second immunosignature profile; and f) determining the disease state or progression of the patient or subject with the autoimmune disease or disorder.

**[0071]** Non-limiting examples of disorders associated with the immune system can include: auto-immune disorders, inflammatory diseases, HIV, rheumatoid arthritis, diabetes mellitus type 1, systemic lupus erythematosus, scleroderma, multiple sclerosis, severe combined immunodeficiency (SCID), DiGeorge syndrome, ataxia-telangiectasia, seasonal allergies, perennial allergies, food allergies, anaphylaxis, mastocytosis, allergic rhinitis, atopic dermatitis, Parkinson's, Alzheimer's, hypersplenism, leukocyte adhesion deficiency, X-linked lymphoproliferative disease, X-linked agammaglobulinemia, selective immunoglobulin A deficiency, hyper IgM syndrome, autoimmune lymphoproliferative syndrome, Wiskott-Aldrich syndrome, chronic granulomatous disease, common variable immunodeficiency (CVID), hyperimmunoglobulin E syndrome, and Hashimoto's thyroiditis.

**[0072]** In preferred embodiments, the immune disorder is an auto-immune disorder. In some embodiments the auto-immune disorder is chosen from the group consisting of Type I diabetes, rheumatoid arthritis, multiple sclerosis, inflammatory bowel disease, systemic lupus erythematosus, psoriasis, and scleroderma.

**[0073]** In further embodiments, the methods, devices and assays disclosed herein measure binding of the samples used herein to generate an immunosignature. Binding activity measured in some instances relates to the binding of mimotope or non-epitope binding interactions. In some instances, the mimotope binding interactions may have higher binding affinity than the cognate epitope. In other instances, the mimotope binding interactions may have lower binding affinity than the cognate epitope. While the corresponding solution-phase binding of the measured binding interactions may be low, the microarrays used and disclosed herein are constructed to enhance the detection of a range of binding interactions that may not be detected in solution phase-based assays.

**[0074]** Accordingly, in some instances, the microarrays used in conjunction with the methods, devices and assays provided herein are constructed to enhance the interaction and detection of binding activities between the samples used herein and the peptides on the array. In some instances, identical or the same peptides are spaced within an assigned feature of the microarray at high density, in some instances between about 0.1 nm to 20 nm, between about 0.5 nm to 15 nm, between about 0.5 nm to 10 nm, between about 0.5 nm to about 7 nm apart, between about 1 nm to about 6 nm apart, between about 1 nm to about 5 nm apart, between about 1 nm to about 4 nm apart, between about 1 nm to about 3 nm apart, between about 1 nm to about 2 nm apart, between about 1 to about 1.5 nm apart, between about 10 nm to 20 nm, between about 15 nm to 20 nm, between about 10 nm to 15 nm, between about 12 nm to 17nm, between about 16 nm to 20 nm or between about 14 nm to 18 nm. In some instances, identical or the same peptides are spaced within an assigned feature of the microarray at less than about 7 nm, less than about 6 nm, less than about 5 nm, less than about 4 nm, less than about 3 nm, less than about 2 nm or less than about 1 nm apart from each other. In other instances, identical or the same peptides are spaced within an assigned feature of the microarray at more than about 5 nm, more than about 6 nm, more than about 7 nm, more than about 8 nm, more than about 9nm, more than about 10 nm, more than about 11 nm, more than about 12 nm, more than about 13 nm, more than about 14 nm, more than about 15 nm, more than about 16 nm, more than about 17 nm, more than about 18 nm, more than about 19 nm, more than about 20 nm. In yet other instances, identical or the same peptides are spaced within an assigned feature on the microarray at about 1 nm, about 2 nm, about 3 nm, about 4 nm, about 5 nm, about 6 nm, about 7 nm, about 8 nm, about 9

nm, about 10 nm, about 11 nm, about 12 nm, about 13 nm, about 14 nm, about 15 nm, about 16 nm, about 17 nm, about 18 nm, about 19 nm, or about 20 nm.

[0075] In some embodiments, the peptides on the microarrays used herein are synthesized in situ on the surface of the array, or are deposited and bound to the surface of the array. In some instances, the peptides are synthesized in either manner using less than 20 different amino acids. In other instances, at least the amino acids methionine, cysteine, isoleucine and threonine are excluded during synthesis of the peptides.

[0076] The invention can provide a method of preventing a condition, the method comprising: a) providing a complex biological sample from a subject; b) contacting the complex biological sample to a peptide array, wherein the peptide array comprises different peptides capable of binding of at least one antibody in the complex biological sample; c) measuring an binding of the complex biological sample to a plurality of the different peptides to form an immunosignature; d) associating the immunosignature with a condition; and e) receiving a treatment for the condition. In some embodiments, a method of the invention can be used in conjunction with a prophylactic treatment.

[0077] In some embodiments, the patient or subject suffers from an infection of, for example, a pathogen. A pathogen can be a pathogenic virus or a pathogenic bacteria. An infection with a pathogenic viruses and/or a pathogenic bacteria can cause a condition, for example, an inflammation. Non-limiting examples of pathogenic bacteria can be found in the: a) *Bordetella* genus, such as *Bordetella pertussis* species; b) *Borrelia* genus, such *Borrelia burgdorferi* species; c) *Brucella* genus, such as *Brucella abortus*, *Brucella canis*, *Brucella meliterisis*, and/or *Brucella suis* species; d) *Campylobacter* genus, such as *Campylobacter jejuni* species; e) *Chlamydia* and *Chlamydophila* genera, such as *Chlamydia pneumonia*, *Chlamydia trachomatis*, and/or *Chlamydophila psittaci* species; f) *Clostridium* genus, such as *Clostridium botulinum*, *Clostridium difficile*, *Clostridium perfringens*, *Clostridium tetani* species; g) *Corynebacterium* genus, such as *Corynebacterium diphtheria* species; h) *Enterococcus* genus, such as *Enterococcus faecalis*, and/or *Enterococcus faecium* species; i) *Escherichia* genus, such as *Escherichia coli* species; j) *Francisella* genus, such as *Francisella tularensis* species; k) *Haemophilus* genus, such as *Haemophilus influenza* species; l) *Helicobacter* genus, such as *Helicobacter pylori* species; m) *Legionella* genus, such as *Legionella pneumophila* species; n) *Leptospira* genus, such as *Leptospira interrogans* species; o) *Listeria* genus, such as *Listeria monocytogenes* species; p) *Mycobacterium* genus, such as *Mycobacterium leprae*, *mycobacterium tuberculosis*, and/or *mycobacterium ulcerans* species; q) *Mycoplasma* genus, such as *Mycoplasma pneumonia* species; r) *Neisseria* genus, such as *Neisseria gonorrhoeae* and/or *Neisseria meningitidis* species; s) *Pseudomonas* genus, such as *Pseudomonas aeruginosa*

species; t) *Rickettsia* genus, such as *Rickettsia rickettsii* species; u) *Salmonella* genus, such as *Salmonella typhi* and/or *Salmonella typhimurium* species; v) *Shigella* genus, such as *Shigella sonnei* species; w) *Staphylococcus* genus, such as *Staphylococcus aureus*, *Staphylococcus epidermidis*, and/or *Staphylococcus saprophyticus* species; x) *Streptococcus* genus, such as *Streptococcus agalactiae*, *Streptococcus pneumoniae*, and/or *Streptococcus pyogenes* species; y) *Treponema* genus, such as *Treponema pallidum* species; z) *Vibrio* genus, such as *Vibrio cholerae*; and/or aa) *Yersinia* genus, such as *Yersinia pestis* species.

**[0078]** Non-limiting examples of viruses can be found in the following families of viruses and are illustrated with exemplary species: a) Adenoviridae family, such as Adenovirus species; b) Herpesviridae family, such as Herpes simplex type 1, Herpes simplex type 2, Varicella-zoster virus, Epstein-barr virus, Human cytomegalovirus, Human herpesvirus type 8 species; c) Papillomaviridae family, such as Human papillomavirus species; d) Polyomaviridae family, such as BK virus, JC virus species; e) Poxviridae family, such as Smallpox species; f) Hepadnaviridae family, such as Hepatitis B virus species; g) Parvoviridae family, such as Human bocavirus, Parvovirus B19 species; h) Astroviridae family, such as Human astrovirus species; i) Caliciviridae family, such as Norwalk virus species; j) Flaviviridae family, such as Hepatitis C virus, yellow fever virus, dengue virus, West Nile virus species; k) Togaviridae family, such as Rubella virus species; l) Hepeviridae family, such as Hepatitis E virus species; m) Retroviridae family, such as Human immunodeficiency virus (HIV) species; n) Orthomyxoviridae family, such as Influenza virus species; o) Arenaviridae family, such as Guanarito virus, Junin virus, Lassa virus, Machupo virus, and/or Sabiá virus species; p) Bunyaviridae family, such as Crimean-Congo hemorrhagic fever virus species; q) Filoviridae family, such as Ebola virus and/or Marburg virus species; Paramyxoviridae family, such as Measles virus, Mumps virus, Parainfluenza virus, Respiratory syncytial virus, Human metapneumovirus, Hendra virus and/or Nipah virus species; r) Rhabdoviridae genus, such as Rabies virus species; s) Reoviridae family, such as Rotavirus, Orbivirus, Coltivirus and/or Banna virus species. In some embodiments, a virus is unassigned to a viral family, such as Hepatitis D.

**[0079]** In some embodiments, the invention provides a method of providing a treatment, the method comprising: a) receiving a complex biological sample from a subject; b) contacting the complex biological sample to a peptide array, wherein the peptide array comprises different peptides capable of binding of at least one antibody in the biological sample; c) measuring the binding of the antibody to a plurality of the different peptides to form an immunosignature; d) associating the immunosignature with a condition; and e) providing the treatment for the condition.

**[0080]** In some embodiments, the invention can provide a method of diagnosis or detection of an autoimmune disorder, the method comprising: a) receiving a complex biological sample from a subject; b) contacting the complex biological sample to a peptide array, wherein the peptide array comprises different peptides capable of binding of at least one antibody in the biological sample; c) measuring the binding of the antibody to a group of different peptides in the peptide array to form an immunosignature; and d) detecting or diagnosing an autoimmune condition based on the immunosignature.

**[0081]** In some embodiments, a method of the invention can be used as a method of diagnosing, monitoring, and treating a condition. A method of treating a condition can require the prescription of a therapeutic agent targeted to treat the subject's condition or disease. In some embodiments, a therapeutic agent can be prescribed in a range of from about 1 mg to about 2000 mg; from about 5 mg to about 1000 mg, from about 10 mg to about 500 mg, from about 50 mg to about 250 mg, from about 100 mg to about 200 mg, from about 1 mg to about 50 mg, from about 50 mg to about 100 mg, from about 100 mg to about 150 mg, from about 150 mg to about 200 mg, from about 200 mg to about 250 mg, from about 250 mg to about 300 mg, from about 300 mg to about 350 mg, from about 350 mg to about 400 mg, from about 400 mg to about 450 mg, from about 450 mg to about 500 mg, from about 500 mg to about 550 mg, from about 550 mg to about 600 mg, from about 600 mg to about 650 mg, from about 650 mg to about 700 mg, from about 700 mg to about 750 mg, from about 750 mg to about 800 mg, from about 800 mg to about 850 mg, from about 850 mg to about 900 mg, from about 900 mg to about 950 mg, or from about 950 mg to about 1000 mg. A user would also adjust the dosage requirements of the therapeutic agent depending upon, for example, severity of the disease, physical parameters of the subject (weight, height and other characteristics) as well as frequency of administration of the prescribed therapeutic agent.

**[0082]** In some embodiments, at least 1 mg, at least 5 mg, at least 15 mg, at least 15 mg, at least 20 mg, at least 25 mg, at least 30 mg, at least 35 mg, at least 40 mg, at least 45 mg, at least 50 mg, at least 55 mg, at least 60 mg, at least 65 mg, at least 70 mg, at least 80 mg, at least 85 mg, at least 90 mg, at least 100 mg, at least 150 mg, at least 200 mg, at least 250 mg, at least 300 mg, at least 350 mg, at least 400 mg, at least 450 mg, at least 500 mg, at least 550 mg, at least 600 mg, at least 650 mg, at least 700 mg, at least 750 mg, at least 800 mg, at least 850 mg, at least 900 mg, at least 950 mg, or at least 1000 mg of the therapeutic agent is prescribed.

**[0083]** The arrays and methods of the invention can be used by a user to determine the health state or condition of a subject or patient. A plurality of users can use a method of the invention to identify and/or provide a treatment of a condition. A user can be, for example, a human who wishes to monitor one's own health. A user can be, for example, a health care provider. A

health care provider can be, for example, a physician. In some embodiments, the user is a health care provider attending the subject. Non-limiting examples of physicians and health care providers that can be users of the invention can include, an anesthesiologist, a bariatric surgery specialist, a blood banking transfusion medicine specialist, a cardiac electrophysiologist, a cardiac surgeon, a cardiologist, a certified nursing assistant, a clinical cardiac electrophysiology specialist, a clinical neurophysiology specialist, a clinical nurse specialist, a colorectal surgeon, a critical care medicine specialist, a critical care surgery specialist, a dental hygienist, a dentist, a dermatologist, an emergency medical technician, an emergency medicine physician, a gastrointestinal surgeon, a hematologist, a hospice care and palliative medicine specialist, a homeopathic specialist, an infectious disease specialist, an internist, a maxillofacial surgeon, a medical assistant, a medical examiner, a medical geneticist, a medical oncologist, a midwife, a neonatal-perinatal specialist, a nephrologist, a neurologist, a neurosurgeon, a nuclear medicine specialist, a nurse, a nurse practitioner, an obstetrician, an oncologist, an oral surgeon, an orthodontist, an orthopedic specialist, a pain management specialist, a pathologist, a pediatrician, a perfusionist, a periodontist, a plastic surgeon, a podiatrist, a proctologist, a prosthetic specialist, a psychiatrist, a pulmonologist, a radiologist, a surgeon, a thoracic specialist, a transplant specialist, a vascular specialist, a vascular surgeon, and a veterinarian. A diagnosis identified with an array and a method of the invention can be incorporated into a subject's medical record. The immunosignature obtained can then be used for identifying therapeutic targets and developing treatments for the individual against the identified autoimmune disorder according to the methods and devices disclosed herein.

**[0084]** Accordingly, the methods, systems and array devices disclosed herein are capable of screening, identifying therapeutic targets, identifying vaccine targets, and/or treating a disease and/or condition at an early stage of the disease and/or condition. For example, the methods, systems and array devices disclosed herein are capable of detecting, diagnosing and monitoring a disease and/or condition days or weeks before traditional biomarker-based assays. Moreover, only one array, *i.e.*, one immunosignature assay, is needed to detect, diagnose and monitor a wide spectra of diseases and conditions, including inflammatory conditions, cancer and pathogenic infections.

#### Classification Algorithms

**[0085]** A plurality of algorithms and classifiers can be used to classify and/or analyze data obtained in an Immunosignaturing array. The Naïve Bayes' algorithm can accommodate the complex patterns hidden within multilayered immunosignaturing microarray data due to its fundamental mathematical properties. A basic classification algorithm, Linear Discriminant

Analysis (LDA) is widely used in analyzing biomedical data in order to classify two or more disease classes. LDA can be, for example, a classification algorithm. A more complex classification method, Support Vector Machines (SVM), uses mathematical kernels to separate classes by a hyperplane, projecting the original predictors to higher-dimensional spaces. Some common kernels include linear, polynomial, sigmoid or radial basis functions. A comparative study of common classifiers described in the art is described in (Kukreja et al, BMC Bioinformatics. 2012; 13: 139).

### **Array platform**

**[0086]** In some embodiments, disclosed herein are methods and process that provide for array platforms that allow for increased diversity and fidelity of chemical library synthesis, The array platforms comprises a plurality of individual features on the surface of the array. Each feature typically comprises a plurality of individual molecules synthesized *in situ* on the surface of the array, wherein the molecules are identical within a feature, but the sequence or identity of the molecules differ between features. The array molecules include, but are not limited to nucleic acids (including DNA, RNA, nucleosides, nucleotides, structure analogs or combinations thereof), peptides, peptide-mimetics, and combinations thereof and the like, wherein the array molecules may comprise natural or non-natural monomers within the molecules. Such array molecules include the synthesis of large synthetic peptide arrays. In some embodiments, a molecule in an array is a mimotope, a molecule that mimics the structure of an epitope and is able to bind an epitope-elicited antibody. In some embodiments, a molecule in the array is a paratope or a paratope mimetic, comprising a site in the variable region of an antibody (or T cell receptor) that binds to an epitope an antigen. In some embodiments, an array of the invention is a peptide array comprising random, pseudo-random or maximally diverse peptide sequences.

**[0087]** The technologies disclosed herein include a photolithographic array synthesis platform that merges semiconductor manufacturing processes and combinatorial chemical synthesis to produce array-based libraries on silicon wafers. By utilizing the tremendous advancements in photolithographic feature patterning, the array synthesis platform is highly-scalable and capable of producing combinatorial chemical libraries with 40 million features on an 8-inch wafer. Photolithographic array synthesis is performed using semiconductor wafer production equipment in a class 10,000 cleanroom to achieve high reproducibility. When the wafer is diced into standard microscope slide dimensions, each slide contains more than 3 million distinct chemical entities.

**[0088]** In some embodiments, arrays with chemical libraries produced by photolithographic technologies disclosed herein are used for immune-based diagnostic assays, for example called

immunosignature assays. Using a patient's antibody repertoire from a drop of blood bound to the arrays, a fluorescence binding profile image of the bound array provides sufficient information to classify disease vs. healthy.

**[0089]** In some embodiments, immunosignature assays are being developed for clinical application to diagnose/monitor autoimmune diseases and to assess response to autoimmune treatments. Exemplary embodiments of immunosignature assays is described in detail in US Pre-Grant Publication No. 2012/0190574, entitled "Compound Arrays for Sample Profiling" and US Pre-Grant Publication No. 2014/0087963, entitled "Immunosignaturing: A Path to Early Diagnosis and Health Monitoring", both of which are incorporated by reference herein for such disclosure. The arrays developed herein incorporate analytical measurement capability within each synthesized array using orthogonal analytical methods including ellipsometry, mass spectrometry and fluorescence. These measurements enable longitudinal qualitative and quantitative assessment of array synthesis performance.

**[0090]** In some embodiments, detection of antibody binding on a peptide array poses some challenges that can be addressed by the technologies disclosed herein. Accordingly, in some embodiments, the arrays and methods disclosed herein utilize specific coatings and functional group densities on the surface of the array that can tune the desired properties necessary for performing immunosignature assays. For example, non-specific antibody binding on a peptide array may be minimized by coating the silicon surface with a moderately hydrophilic monolayer polyethylene glycol (PEG), polyvinyl alcohol, carboxymethyl dextran, and combinations thereof. In some embodiments, the hydrophilic monolayer is homogeneous. Second, synthesized peptides are linked to the silicon surface using a spacer that moves the peptide away from the surface so that the peptide is presented to the antibody in an unhindered orientation.

### **Detector device**

**[0091]** In some embodiments, the systems, platforms and methods disclosed herein include a detector device for detecting binding on the array formats disclosed herein, including antibody binding on the peptide arrays disclosed herein. In some embodiments, used in conjunction with optical detection methods (ccd, pmt, other optical detector, optical filters and other optical detection devices), detection of antibody binding is reported via optical detection in real-time or on a timed interval. In certain instances, quantification of final binding activity is reported via optical detection converted to AFU (arbitrary fluorescence units) or translated to electrical signal via impedance measurement or other electrochemical sensing. In other instances, antibody binding is detected by an emission or absorption of light or electromagnetic energy, either in the visible range or otherwise from an optically-detectable label on a probe applied to the peptide

device. Optically detectable labels include, without limitation, fluorescent, chemiluminescent, electrochemiluminescent, luminescent, phosphorescent, fluorescence polarization, and charge labels. In some instances, a fluorescently labeled probe is active only in the presence of a specific target or antibody so that a fluorescent response from a sample signifies the presence of the target or antibody.

**[0092]** In some instances, light delivery schemes are utilized to provide the optical excitation and/or emission and/or detection of antibody binding. In certain embodiments, this includes using the flow cell materials (thermal polymers like acrylic (PMMA) cyclic olefin polymer (COP), cyclic olefin co-polymer, (COC), etc.) as optical wave guides to remove the need to use external components. In addition, in some instances light sources - light emitting diodes - LEDs, vertical-cavity surface-emitting lasers - VCSELs, and other lighting schemes are integrated directly inside the cartridge or detection device or built directly onto the peptide array surface to have internally controlled and powered light sources. PMTs, CCDs, or CMOS detectors can also be built into the detection device or cartridge.

### **Digital processing device**

**[0093]** In some embodiments, the systems, platforms, software, networks, and methods described herein include a digital processing device, or use of the same. In further embodiments, the digital processing device includes one or more hardware central processing units (CPUs), i.e., processors that carry out the device's functions. In still further embodiments, the digital processing device further comprises an operating system configured to perform executable instructions. In some embodiments, the digital processing device is optionally connected a computer network. In further embodiments, the digital processing device is optionally connected to the Internet such that it accesses the World Wide Web. In still further embodiments, the digital processing device is optionally connected to a cloud computing infrastructure. In other embodiments, the digital processing device is optionally connected to an intranet. In other embodiments, the digital processing device is optionally connected to a data storage device.

**[0094]** In accordance with the description herein, suitable digital processing devices include, by way of non-limiting examples, server computers, desktop computers, laptop computers, notebook computers, sub-notebook computers, netbook computers, netpad computers, set-top computers, handheld computers, Internet appliances, mobile smartphones, tablet computers, personal digital assistants, video game consoles, and vehicles. Those of skill in the art will recognize that many smartphones are suitable for use in the system described herein. Those of skill in the art will also recognize that select televisions, video players, and digital music players with optional computer network connectivity are suitable for use in the system described herein.

Suitable tablet computers include those with booklet, slate, and convertible configurations, known to those of skill in the art.

**[0095]** In some embodiments, a digital processing device includes an operating system configured to perform executable instructions. The operating system is, for example, software, including programs and data, which manages the device's hardware and provides services for execution of applications. Those of skill in the art will recognize that suitable server operating systems include, by way of non-limiting examples, FreeBSD, OpenBSD, NetBSD<sup>®</sup>, Linux, Apple<sup>®</sup> Mac OS X Server<sup>®</sup>, Oracle<sup>®</sup> Solaris<sup>®</sup>, Windows Server<sup>®</sup>, and Novell<sup>®</sup> NetWare<sup>®</sup>. Those of skill in the art will recognize that suitable personal computer operating systems include, by way of non-limiting examples, Microsoft<sup>®</sup> Windows<sup>®</sup>, Apple<sup>®</sup> Mac OS X<sup>®</sup>, UNIX<sup>®</sup>, and UNIX-like operating systems such as GNU/Linux<sup>®</sup>. In some embodiments, the operating system is provided by cloud computing. Those of skill in the art will also recognize that suitable mobile smart phone operating systems include, by way of non-limiting examples, Nokia<sup>®</sup> Symbian<sup>®</sup> OS, Apple<sup>®</sup> iOS<sup>®</sup>, Research In Motion<sup>®</sup> BlackBerry OS<sup>®</sup>, Google<sup>®</sup> Android<sup>®</sup>, Microsoft<sup>®</sup> Windows Phone<sup>®</sup> OS, Microsoft<sup>®</sup> Windows Mobile<sup>®</sup> OS, Linux<sup>®</sup>, and Palm<sup>®</sup> WebOS<sup>®</sup>.

**[0096]** In some embodiments, a digital processing device includes a storage and/or memory device. The storage and/or memory device is one or more physical apparatuses used to store data or programs on a temporary or permanent basis. In some embodiments, the device is volatile memory and requires power to maintain stored information. In some embodiments, the device is non-volatile memory and retains stored information when the digital processing device is not powered. In further embodiments, the non-volatile memory comprises flash memory. In some embodiments, the non-volatile memory comprises dynamic random-access memory (DRAM). In some embodiments, the non-volatile memory comprises ferroelectric random access memory (FRAM). In some embodiments, the non-volatile memory comprises phase-change random access memory (PRAM). In other embodiments, the device is a storage device including, by way of non-limiting examples, CD-ROMs, DVDs, flash memory devices, magnetic disk drives, magnetic tapes drives, optical disk drives, and cloud computing based storage. In further embodiments, the storage and/or memory device is a combination of devices such as those disclosed herein.

**[0097]** In some embodiments, a digital processing device includes a display to send visual information to a user. In some embodiments, the display is a cathode ray tube (CRT). In some embodiments, the display is a liquid crystal display (LCD). In further embodiments, the display is a thin film transistor liquid crystal display (TFT-LCD). In some embodiments, the display is an organic light emitting diode (OLED) display. In various further embodiments, an OLED display is a passive-matrix OLED (PMOLED) or active-matrix OLED (AMOLED) display. In

some embodiments, the display is a plasma display. In other embodiments, the display is a video projector. In still further embodiments, the display is a combination of devices such as those disclosed herein.

**[0098]** In some embodiments, a digital processing device includes an input device to receive information from a user. In some embodiments, the input device is a keyboard. In some embodiments, the input device is a pointing device including, by way of non-limiting examples, a mouse, trackball, track pad, joystick, game controller, or stylus. In some embodiments, the input device is a touch screen or a multi-touch screen. In other embodiments, the input device is a microphone to capture voice or other sound input. In other embodiments, the input device is a video camera to capture motion or visual input. In still further embodiments, the input device is a combination of devices such as those disclosed herein.

**[0099]** In some embodiments, a digital processing device includes a digital camera. In some embodiments, a digital camera captures digital images. In some embodiments, the digital camera is an autofocus camera. In some embodiments, a digital camera is a charge-coupled device (CCD) camera. In further embodiments, a digital camera is a CCD video camera. In other embodiments, a digital camera is a complementary metal-oxide-semiconductor (CMOS) camera. In some embodiments, a digital camera captures still images. In other embodiments, a digital camera captures video images. In various embodiments, suitable digital cameras include 1, 2, 3, 4, 5, 6, 7, 8, 9, 10, 11, 12, 13, 14, 15, 16, 17, 18, 19, 20, 21, 22, 23, 24, 25, 26, 27, 28, 29, 30, and higher megapixel cameras, including increments therein. In some embodiments, a digital camera is a standard definition camera. In other embodiments, a digital camera is an HD video camera. In further embodiments, an HD video camera captures images with at least about 1280 x about 720 pixels or at least about 1920 x about 1080 pixels. In some embodiments, a digital camera captures color digital images. In other embodiments, a digital camera captures grayscale digital images. In various embodiments, digital images are stored in any suitable digital image format. Suitable digital image formats include, by way of non-limiting examples, Joint Photographic Experts Group (JPEG), JPEG 2000, Exchangeable image file format (Exif), Tagged Image File Format (TIFF), RAW, Portable Network Graphics (PNG), Graphics Interchange Format (GIF), Windows<sup>®</sup> bitmap (BMP), portable pixmap (PPM), portable graymap (PGM), portable bitmap file format (PBM), and WebP. In various embodiments, digital images are stored in any suitable digital video format. Suitable digital video formats include, by way of non-limiting examples, AVI, MPEG, Apple<sup>®</sup> QuickTime<sup>®</sup>, MP4, AVCHD<sup>®</sup>, Windows Media<sup>®</sup>, DivX<sup>™</sup>, Flash Video, Ogg Theora, WebM, and RealMedia.

**Non-transitory computer readable storage medium**

[00100] In some embodiments, the systems, platforms, software, networks, and methods disclosed herein include one or more non-transitory computer readable storage media encoded with a program including instructions executable by the operating system of an optionally networked digital processing device. In further embodiments, a computer readable storage medium is a tangible component of a digital processing device. In still further embodiments, a computer readable storage medium is optionally removable from a digital processing device. In some embodiments, a computer readable storage medium includes, by way of non-limiting examples, CD-ROMs, DVDs, flash memory devices, solid state memory, magnetic disk drives, magnetic tape drives, optical disk drives, cloud computing systems and services, and the like. In some cases, the program and instructions are permanently, substantially permanently, semi-permanently, or non-transitorily encoded on the media.

**Computer program**

[00101] In some embodiments, the systems, platforms, software, networks, and methods disclosed herein include at least one computer program. A computer program includes a sequence of instructions, executable in the digital processing device's CPU, written to perform a specified task. In light of the disclosure provided herein, those of skill in the art will recognize that a computer program may be written in various versions of various languages. In some embodiments, a computer program comprises one sequence of instructions. In some embodiments, a computer program comprises a plurality of sequences of instructions. In some embodiments, a computer program is provided from one location. In other embodiments, a computer program is provided from a plurality of locations. In various embodiments, a computer program includes one or more software modules. In various embodiments, a computer program includes, in part or in whole, one or more web applications, one or more mobile applications, one or more standalone applications, one or more web browser plug-ins, extensions, add-ins, or add-ons, or combinations thereof.

**Web application**

[00102] In some embodiments, a computer program includes a web application. In light of the disclosure provided herein, those of skill in the art will recognize that a web application, in various embodiments, utilizes one or more software frameworks and one or more database systems. In some embodiments, a web application is created upon a software framework such as Microsoft<sup>®</sup> .NET or Ruby on Rails (RoR). In some embodiments, a web application utilizes one or more database systems including, by way of non-limiting examples, relational, non-relational, object oriented, associative, and XML database systems. In further embodiments, suitable

relational database systems include, by way of non-limiting examples, Microsoft<sup>®</sup> SQL Server, MySQL<sup>™</sup>, and Oracle<sup>®</sup>. Those of skill in the art will also recognize that a web application, in various embodiments, is written in one or more versions of one or more languages. A web application may be written in one or more markup languages, presentation definition languages, client-side scripting languages, server-side coding languages, database query languages, or combinations thereof. In some embodiments, a web application is written to some extent in a markup language such as Hypertext Markup Language (HTML), Extensible Hypertext Markup Language (XHTML), or eXtensible Markup Language (XML). In some embodiments, a web application is written to some extent in a presentation definition language such as Cascading Style Sheets (CSS). In some embodiments, a web application is written to some extent in a client-side scripting language such as Asynchronous Javascript and XML (AJAX), Flash<sup>®</sup> Actionscript, Javascript, or Silverlight<sup>®</sup>. In some embodiments, a web application is written to some extent in a server-side coding language such as Active Server Pages (ASP), ColdFusion<sup>®</sup>, Perl, Java<sup>™</sup>, JavaServer Pages (JSP), Hypertext Preprocessor (PHP), Python<sup>™</sup>, Ruby, Tcl, Smalltalk, WebDNA<sup>®</sup>, or Groovy. In some embodiments, a web application is written to some extent in a database query language such as Structured Query Language (SQL). In some embodiments, a web application integrates enterprise server products such as IBM<sup>®</sup> Lotus Domino<sup>®</sup>. A web application for providing a career development network for artists that allows artists to upload information and media files, in some embodiments, includes a media player element. In various further embodiments, a media player element utilizes one or more of many suitable multimedia technologies including, by way of non-limiting examples, Adobe<sup>®</sup> Flash<sup>®</sup>, HTML 5, Apple<sup>®</sup> QuickTime<sup>®</sup>, Microsoft<sup>®</sup> Silverlight<sup>®</sup>, Java<sup>™</sup>, and Unity<sup>®</sup>.

### **Mobile application**

**[00103]** In some embodiments, a computer program includes a mobile application provided to a mobile digital processing device. In some embodiments, the mobile application is provided to a mobile digital processing device at the time it is manufactured. In other embodiments, the mobile application is provided to a mobile digital processing device via the computer network described herein.

**[00104]** In view of the disclosure provided herein, a mobile application is created by techniques known to those of skill in the art using hardware, languages, and development environments known to the art. Those of skill in the art will recognize that mobile applications are written in several languages. Suitable programming languages include, by way of non-limiting examples, C, C++, C#, Objective-C, Java<sup>™</sup>, Javascript, Pascal, Object Pascal,

Python™, Ruby, VB.NET, WML, and XHTML/HTML with or without CSS, or combinations thereof.

[00105] Suitable mobile application development environments are available from several sources. Commercially available development environments include, by way of non-limiting examples, AirplaySDK, alcheMo, Appcelerator®, Celsius, Bedrock, Flash Lite, .NET Compact Framework, Rhomobile, and WorkLight Mobile Platform. Other development environments are available without cost including, by way of non-limiting examples, Lazarus, MobiFlex, MoSync, and Phonegap. Also, mobile device manufacturers distribute software developer kits including, by way of non-limiting examples, iPhone and iPad (iOS) SDK, Android™ SDK, BlackBerry® SDK, BREW SDK, Palm® OS SDK, Symbian SDK, webOS SDK, and Windows® Mobile SDK.

[00106] Those of skill in the art will recognize that several commercial forums are available for distribution of mobile applications including, by way of non-limiting examples, Apple® App Store, Android™ Market, BlackBerry® App World, App Store for Palm devices, App Catalog for webOS, Windows® Marketplace for Mobile, Ovi Store for Nokia® devices, Samsung® Apps, and Nintendo® DSi Shop.

### **Standalone application**

[00107] In some embodiments, a computer program includes a standalone application, which is a program that is run as an independent computer process, not an add-on to an existing process, e.g., not a plug-in. Those of skill in the art will recognize that standalone applications are often compiled. A compiler is a computer program(s) that transforms source code written in a programming language into binary object code such as assembly language or machine code. Suitable compiled programming languages include, by way of non-limiting examples, C, C++, Objective-C, COBOL, Delphi, Eiffel, Java™, Lisp, Python™, Visual Basic, and VB .NET, or combinations thereof. Compilation is often performed, at least in part, to create an executable program. In some embodiments, a computer program includes one or more executable compiled applications.

### **Software modules**

[00108] The systems, platforms, software, networks, and methods disclosed herein include, in various embodiments, software, server, and database modules. In view of the disclosure provided herein, software modules are created by techniques known to those of skill in the art using machines, software, and languages known to the art. The software modules disclosed herein are implemented in a multitude of ways. In various embodiments, a software module comprises a file, a section of code, a programming object, a programming structure, or

combinations thereof. In further various embodiments, a software module comprises a plurality of files, a plurality of sections of code, a plurality of programming objects, a plurality of programming structures, or combinations thereof. In various embodiments, the one or more software modules comprise, by way of non-limiting examples, a web application, a mobile application, and a standalone application. In some embodiments, software modules are in one computer program or application. In other embodiments, software modules are in more than one computer program or application. In some embodiments, software modules are hosted on one machine. In other embodiments, software modules are hosted on more than one machine. In further embodiments, software modules are hosted on cloud computing platforms. In some embodiments, software modules are hosted on one or more machines in one location. In other embodiments, software modules are hosted on one or more machines in more than one location.

## EXAMPLES

### Example 1 – Testing of SLE Patient Samples

**[00109] Background/Methods:** The study design consisted of 356 samples from 183 patients who met ACR criteria for SLE at the time of diagnosis. The samples were selected to cover a wide range of SLEDAI scores correlated with the collected samples, which ranged from remission (SLEDAI score = 0), mild (SLEDAI score= 1-4), moderate (SLEDAI score= 5-10) and severe (SLEDAI score greater than 11).

**[00110]** The patients were screened according to criteria developed by the American College of Rheumatology (ACR) to diagnose and identify patients with SLE. 90% of the subjects in the study were female, age range between 1 and 69 years of age (median of 39 years), with 52% of the subjects of Hispanic origin, 31% of African-American origin, 12% of Afro-Caribbean origin and 5% other or of mixed origin.

**[00111]** Patient sample were collected for up to 10 time points with the number of blood draws per patient ranging from 1 to 10 blood draws. A median of 6 months (range of 1 week to 4 years) were measured between blood draws. The samples were incubated on peptide arrays containing 126,000 unique peptides, washed, incubated with a secondary antibody to visualize peptide:antibody interactions on the array, washed again and imaged.

**[00112]** The data was processed by measuring the intensities of each data point, which was then logarithmically transformed, and normalized by subtracting its median intensity. Peptides associated with active disease were identified by t-test; peptides that correlate with SLEDAI scores were identified by Pearson correlation. Support Vector Machine (SVM) classifiers were employed to train and distinguish remission from increasing levels of SLE activity in each sample. *See* Cortes, C.; Vapnik, V. (1995). "Support-vector networks". *Machine Learning*. **20**

(3): 273–297. SVMs find the optimal hyperplane that separates classes of peptides, the instant case based on immunosignature peptide signals. In “feature space” each peptide’s signal is a dimension that characterizes each sample. “Support Vectors” are training samples that define the boundary between the classes, *i.e.*, those data points hardest to classify)

[00113] Regression models of SLEDAI were also employed and trained using the Elastic Net Feature selection (*see, e.g.*, Zou, Hui; Hastie, Trevor (2005). "Regularization and Variable Selection via the Elastic Net". *Journal of the Royal Statistical Society, Series B*: 301–320; Hastie, Tibshirani and Friedman, *The Elements of Statistical Learning*, 2<sup>nd</sup> ed. (2008)) procedure to constrain model complexity. The Elastic Net approach applies Ridge Regression and LASSO penalties, where correlated features tend to be removed as groups. Briefly, Ridge Regression constrains the sum of coefficients to reduce overfit while reducing magnitude of coefficients, but does not eliminate features. The LASSO approach adds a quadratic term that leads to feature selection, but feature selection is unstable when features are correlated. Five-fold cross validation was used to correct for overfit. *See FIG. 3; see also* Frank. E Harrell, Jr., *Regression Modelling Strategies*, Springer Science+Business Media Inc. (2001).

[00114] **Results:** FIG. 4 illustrates a volcano plot of peptides that distinguish active SLE from inactive (remission) SLE patients. The x-axis is the p-value obtained (Welch t-test) for the ratio of mean active disease (mean(active)) vs. mean inactive disease (mean (inactive)). The discriminating peptides obtained with immunosignature peptide arrays (IMS) was additionally plotted against sensitivity and specificity performance for anti-ds DNA, UPCR (urine protein/creatinine ratio) and C3 protein biomarker measurements. FIG. 5 shows Receiver-Operator Characteristic curves for an Immunosignature (IS) model of disease activity compared to biomarkers ds-DNA, C3, and proteinuria, for identifying patients with active disease (SLEDAI >0). The gray region indicates the 95% confidence interval of the IS Model, assessed using 5-fold cross validation. Discrimination was improved by training on extreme scores (SLEDAI >8 vs. 0), and performance was greater when applied to extreme contrasts. For example, a classifier of SLEDAI >15 vs. 0 had an AUC of 0.90 (95% CI 0.88 - 0.92). Preliminary analysis indicates that samples may be binned by IS into low, medium, and high disease activity. Correlations of a linear IS model ( $r^2=0.23$ ), C3 ( $r^2=0.17$ ) and anti-dsDNA ( $r^2=0.13$ ) to SLEDAI were also determined

[00115] FIG. 6 illustrates the top 702 peptides in the assay that were associated with SLEDAI results. The patients were first grouped by SLEDAI test scores, then clustered according to the peptides identified. The amino acid composition of each top associated peptide was also identified. The top peptides were used to search a human proteome database to determine peptides that aligned with known human proteins. *See FIG. 7.* Total overlap scores were first

obtained to map the distribution of the discrimination peptides to the proteome. The top 20 overlap scores were further analyzed, and found to correspond with known proteins involved in inflammation, including HTN (1,3), PROK2 and CCL28, as well as calcium signaling (for example, NRG1 and S100Z), ribosomal proteins (RPL39(L)), and proteins associated with DNA and chromatin regulation, including Histone 2B (FM, FWT), VCX (1,2, 3A), TNP1, PRR13 and TP53TC3. Moreover, alignment was also found with uncharacterized proteins, including CCER1, LCE1A and C1orf115. An alignment of exemplary peptides to NRG1 is also shown, with characteristics common to the discriminating peptides obtained.

[00116] **FIG. 8** shows a range of SVM classifiers of active vs. inactive SLE. The graph demonstrates that the higher activity of SLE is easily distinguished from SLE subjects in remission.

[00117] The results also support that immunosignature models can correlate with SLEDAI scores either as well or better than standard biomarkers. Additionally,

[00118] **FIG. 9** shows cross-validated model predictions. Correlations of the immunosignature classifications, complement, and anti-dsDNA, C3, C4 and UPCR biomarkers to the SLEDAI scores were determined. The data demonstrates the accuracy of immunosignature models (IMS model) against several biomarkers, including antiDNA, C3, C4 and UPCR biomarkers. Longitudinal results in **FIG. 10** supports that antibody binding in immunosignature models (ISM Model) are more closely related to changes in SLEDAI than changes in other biomarkers, including C3, antiDNA and UPCR.

[00119] **FIG. 11** further demonstrates the improvement that an immunosignature adds to biomarker predictive capacity, and vice versa. Changes in biomarkers between physician visits are often used to monitor a patient's disease activity. Elastic net models of changes in SLEDAI scores were fit using changes in peptide intensities, and/or changes in anti-dsDNA, UPCR and C3 biomarkers, between successive blood draws (n=167). While as above, changes in antibody binding as seen in immunosignatures (*see FIG. 11*, middle figure) provided a better substitute for changes in SLEDAI state than changes in biomarkers, either individually or combined (*i.e.*, anti-dsDNA + UPCR + C3 (**FIG. 11**, left figure), immunosignature assay also benefited in improved predictability when combined with biomarker changes. *See FIG. 11*, right figure.

[00120] **FIG. 12** further demonstrates the difference in immune response that increases with increasing SLEDAI scores, as compared to remission. In this study, trained support vector machine (SVM) classifiers were employed to distinguish active from inactive disease. A series of models was trained with "active" defined by increasing SLEDAI threshold. This was in comparison to training only on the 1<sup>st</sup> blood draw from each patient. A five-fold cross validation

was used to control for overfit in the training set. The models were verified using other blood draws not used in training.

**[00121] Conclusions:** A simple test that uses specific binding patterns of peripheral-blood antibodies on a peptide array can deliver a single, molecular determination of SLE disease activity.

### **Example 2 – Correlation of SLEDAI Diagnosis and SLE Disease Activity**

**[00122]** Immunosignatures for diagnosis and identification of SLE disease activity was determined as above in Example 1 using subjects in a group of subjects having SLE.

Immunosignature assays were performed as described in **Example 1** and scanned to acquire signal intensity measurements at each feature. Peptide features that showed differential signal between groups were determined by t-test of mean peptide intensities with the Welch adjustment for unequal variances. A binary classifier was developed for each of the contrasts.

**[00123]** Significant Peptides that correlated SLE with SLEDAI score was determined.

**Figures 13A-13G** show the motifs and amino acids that were enriched in the discriminating significant peptides in the study. In each of the tables of **Figures 13A-13G**:

**[0001]** “n” = the number of times the motif occurs in the top discriminating peptides;

**[0002]** n. lib = the number of times the motif occurs in the array library

**[0003]** “enrich” = the fold enrichment of a motif in the top discriminating peptides relative to the number of times the motif occurs in the array library.

**[0004]** P=the statistical significance of the occurrence of a motif in the top discriminating peptides

**[0005]** **Fold enrichment**= (no of times a motif (e.g. ABCD) occurs in the list/no of times the motif (ABCD) occurs in the library)/ (Total no the motif type (e.g. tetramer) occurs in the list/over total no the motif type (e.g. tetramers) in library). **Percent enrichment** is “enrichment” X 100.

**[00124]** While preferred embodiments of the present invention have been shown and described herein, it will be obvious to those skilled in the art that such embodiments are provided by way of example only. Numerous variations, changes, and substitutions will now occur to those skilled in the art without departing from the invention. It should be understood that various alternatives to the embodiments of the invention described herein may be employed in practicing the invention. It is intended that the following claims define the scope of the invention and that methods and structures within the scope of these claims and their equivalents be covered thereby.

## CLAIMS

## WHAT IS CLAIMED IS:

1. A method for determining autoimmune disease activity in a subject, said method comprising:
  - (a) contacting a sample from the subject to a peptide array comprising a plurality of different peptides on distinct features of the array;
  - (b) detecting the binding of antibodies present in the sample to a set of peptides on the peptide array to obtain a pattern of binding signals, wherein the set of peptides are indicative of autoimmune disease activity; and
  - (c) comparing said binding signal to reference binding signals obtained from a plurality of subjects in a reference group having a range of disease activities to determine the presence and/or severity of autoimmune disease activity in said subject.
2. The method of claim 1, wherein the peptide array comprises at least 10,000 different peptides.
3. The method of claim 1, wherein the peptide array comprises at least 50,000 different peptides.
4. The method of claim 1, wherein the peptide array comprises at least 100,000 different peptides.
5. The method of claim 1, wherein the different peptides on the array are deposited.
6. The method of claim 1, wherein the different peptides on the array are synthesized in situ.
7. The method of claim 6, wherein the synthesis of peptides in situ comprises less than 20 different amino acids.
8. The method of claim 7, wherein cysteine, methionine, isoleucine and threonine are excluded during synthesis of the peptide array.
9. The method of claim 1, wherein the autoimmune disease comprises systemic lupus erythematosus (SLE), rheumatoid arthritis, Sjogren's disease, multiple sclerosis, ulcerative colitis, psoriatic arthritis, scleroderma and/or type I diabetes.
10. The method of claim 1, wherein the autoimmune disease is systemic lupus erythematosus (SLE).

11. The method of claim 10, wherein the binding signal of the set of peptides indicative of SLE in the reference samples are higher in subjects from the reference group having a score of at least 12 when using SLEDAI or SLEDAI-SELENA scoring system.
12. The method of claim 10, wherein the binding signal of the set of peptides indicative of SLE in the reference samples are lower in subjects from the reference having score of less than 2 when using SLEDAI or SLEDAI-SELENA scoring system.
13. The method of claim 10, wherein the binding signal of the set of peptides indicative of SLE in the reference samples are lower in subjects from the reference group having a score of at least 12 when using SLEDAI or SLEDAI-SELENA scoring system.
14. The method of claim 10, wherein the binding signal of the set of peptides indicative of SLE in the reference samples are lower in subjects from the reference group having a score of less than 2 when using SLEDAI or SLEDAI-SELENA scoring system.
15. The method of claims 11-14, wherein the set of peptides indicative of SLE in the reference samples are enriched by greater than 100% in one or more sequence motifs or amino acids listed in Figures 13A-13G.
16. The method of claim 1, wherein the average binding signal of the set of peptides indicative of an autoimmune disorder in the reference samples is lower in subjects from said reference group having high disease activity than the average binding signal of said peptides from subjects in said reference group having higher disease activity.
17. The method of claims 11-15, wherein the set of peptides indicative of SLE are enriched by at least 150% in at least one or more amino acids as compared to the remaining peptides in the peptide array.
18. The method of claims 1-17, wherein the set of peptides comprises at least 10 peptides, at least 20 peptides, at least 30 peptides, at least 40 peptides, at least 50 peptides, at least 60 peptides, at least 70 peptides, at least 80 peptides, at least 90 peptides or at least 100 peptides are indicative of autoimmune disease activity.
19. The method of claim 1, wherein the pattern of binding signals obtained classifies said autoimmune disease activity selected from low disease activity, moderate disease activity, and severe disease activity.
20. The method of claim 1, wherein a calculated area under the receiver operator characteristic (ROC) curve (AUC) ranging from 0.60 to 0.70, 0.70 to 0.79, 0.80 to 0.89, or 0.90 to 1.0 determines the presence and/or severity of autoimmune disease activity in said subject.

21. The method of claims 11-16, wherein a range of disease activities is further determined by the presence of one or more clinical conditions comprising high anti-dsDNA antibodies, low complement protein C3, low complement protein C4, high antinuclear antibody (ANA), high proteinuria, malar rash, CNS manifestation, arthritis, cytopenia, discoid rash, oral ulcers, renal manifestation, immunologic, photosensitivity, and serositis.
22. The method of claims 1-21, wherein a range of disease activities is further determined by the presence of a known biomarker of one or more clinical conditions.
23. The method of any of the claims above, wherein the subject is human.
24. The method of claim 23, wherein the sample is a blood sample selected from whole blood, plasma, or serum.
25. The method of any of the claims above, wherein the sample is a serum sample.
26. The method of any of the claims above, wherein the sample is a plasma sample.
27. The method of any of the claims above, wherein the sample is a dried blood sample.
28. The method of claim 1, wherein the at least 10,000 different peptides on the peptide array are at least 5 amino acids in length.
29. The method of claim 1, wherein the at least 10,000 different peptides on the peptide array are at least between 5 and 15 amino acids in length.
30. The method of claim 1, wherein the at least 10,000 different peptides are synthesized from less than 20 amino acids.
31. The method of claim 1, wherein the at least 10,000 different peptides on the peptide array are synthesized by excluding one or more of cysteine, methionine, isoleucine and threonine.
32. An immunosignature of a subject indicative of an autoimmune disorder obtained from a sample, wherein the immunosignature comprises a binding pattern from a set of peptides on a peptide array comprising at least 10,000 peptides.
33. The immunosignature of claim 32, wherein the immunosignature comprises an enrichment of at least one amino acid in the set of peptides by at least 150%, as compared to remaining peptides on the peptide array.
34. The immunosignature of claims 32 and 33, wherein the peptide array comprises at least 5,000 different peptides.

35. The immunosignature of claims 32-34, wherein the peptide array comprises at least 50,000 different peptides.
36. The immunosignature of claims 32-35, wherein the peptide array comprises at least 100,000 different peptides.
37. The immunosignature of claims 32-36, wherein the peptide array comprises at least 250,000 peptides.
38. The immunosignature of claims 32-37, wherein the peptide array comprises at least 330,000 peptides.
39. The immunosignature of claims 32-38, wherein the autoimmune disease comprises systemic lupus erythematosus (SLE), rheumatoid arthritis, Sjogren's disease, multiple sclerosis, ulcerative colitis, psoriatic arthritis, scleroderma and/or type I diabetes.
40. The immunosignature of claims 32-39, wherein the autoimmune disease is systemic lupus erythematosus (SLE).
41. The immunosignature of claim 40, wherein an average binding signal from the set of peptides indicative of SLE in the reference samples are higher in subjects from the reference group having a score of at least 12 when using SLEDAI or SLEDAI-SELENA scoring system.
42. The immunosignature of claim 40, wherein an average binding signal of the set of peptides indicative of SLE in the reference samples are lower in subjects from the reference having score of less than 2 when using SLEDAI or SLEDAI-SELENA scoring system.
43. The immunosignature of claim 40, wherein an average binding signal of the set of peptides indicative of SLE in the reference samples are lower in subjects from the reference group having a score of at least 12 when using SLEDAI or SLEDAI-SELENA scoring system.
44. The immunosignature of claim 40, wherein an average binding signal of the set of peptides indicative of SLE in the reference samples are lower in subjects from the reference group having a score of less than 2 when using SLEDAI or SLEDAI-SELENA scoring system.
45. The immunosignature of claims 41-44, wherein the set of peptides indicative of SLE in the reference samples are enriched by greater than 100% in one or more sequence motifs or amino acids listed in Figures 13A-13G.
46. The immunosignature of claims 32-45, wherein an average binding signal of the set of peptides indicative of an autoimmune disorder in the reference samples is lower in subjects from said reference group having high disease activity than the average binding signal of said peptides from subjects in said reference group having higher disease activity.

47. The immunosignature of claims 32-45, wherein an average binding signal of the set of peptides classifies said disease activity selected from low disease activity, moderate disease activity, and severe disease activity.
48. The immunosignature of claim 47, wherein a method performance of the average binding signal obtained is characterized by an area under the receiver operator characteristic (ROC) curve (AUC) ranging from 0.60 to 0.70, 0.70 to 0.79, 0.80 to 0.89, or 0.90 to 1.0.
49. The immunosignature of claims 32-48, wherein a range of disease activities is determined by the presence of one or more clinical conditions comprising high anti-dsDNA antibodies, low complement protein C3, low complement protein C4, high antinuclear antibody (ANA), high proteinuria, malar rash, CNS manifestation, arthritis, cytopenia, discoid rash, oral ulcers, renal manifestation, immunologic, photosensitivity, and serositis.
50. The immunosignature of claims 32-49, wherein the subject is human.
51. The immunosignature of claims 32-50, wherein the sample is a blood sample.
52. The immunosignature of claims 32-51, wherein the blood sample is selected from whole blood, plasma, or serum.
53. The immunosignature of claims 32-52, wherein the sample is a serum sample.
54. The immunosignature of claims 32-53, wherein the sample is a plasma sample.
55. The immunosignature of claims 32-54, wherein the sample is a dried blood sample.
56. The immunosignature of claim 32, wherein the at least 10,000 different peptides on the peptide array is between 5 and 15 amino acids in length.
57. A system for determining autoimmune disease activity in a subject, the system comprising:
  - (a) an array of peptides comprising at least 10,000 different peptides synthesized in situ, wherein a sample from a subject is contacted to the array;
  - (b) a detector for detecting the binding of antibodies present in said sample to a set of peptides on said array to obtain a combination of binding signals; and
  - (c) a digital processing device for analyzing and comparing said combination of binding signals to one or more groups of combinations of reference binding signals, wherein each of said groups of combinations of reference binding signals comprises a combination of binding signals obtained from a plurality of healthy subjects, thereby determining whether the subject has an autoimmune disease.
58. The system of claim 57, wherein the autoimmune disease is SLE.

FIG. 1A

Physicians Global Assessment \_\_\_\_\_

0 1 2 3  
None Mild Med Severe

**SLEDAI SCORE**

Check box: If descriptor is present at the time of visit or in the proceeding 10 days

| Wt | Present                  | Descriptor             | Definition   |
|----|--------------------------|------------------------|--|
| 8  | <input type="checkbox"/> | Seizure                | Recent onset. Exclude metabolic, infectious or drug cause  |
| 8  | <input type="checkbox"/> | Psychosis              | Altered ability to function in normal activity due to severe disturbance in the perception of reality. Include hallucinations, incoherence, marked loose associations, impoverished thought content, marked illogical thinking, bizarre, disorganized, or catatonic behavior. Excluded uremia and drug causes.   |
| 8  | <input type="checkbox"/> | Organic Brain Syndrome | Altered mental function with impaired orientation, memory or other intelligent function, with rapid onset fluctuating clinical features. Include clouding of consciousness with reduced capacity to focus, and inability to sustain attention to environment, plus at least two of the following: perceptual disturbance, incoherent speech, insomnia or daytime drowsiness, or increased or decreased psychomotor activity. Exclude metabolic, infectious or drug causes. |
| 8  | <input type="checkbox"/> | Visual Disturbance     | Retinal changes of SLE. Include cytoid bodies, retinal hemorrhages, serous exudate or hemorrhages in the choroids, or optic neuritis. Exclude hypertension, infection, or drug causes.   |
| 8  | <input type="checkbox"/> | Cranial Nerve Disorder | New onset of sensory or motor neuropathy involving cranial nerves.   |
| 8  | <input type="checkbox"/> | Lupus Headache         | Severe persistent headache: may be migrainous, but must be non-responsive to narcotic analgesia.   |
| 8  | <input type="checkbox"/> | CVA                    | New onset of cerebrovascular accident(s). Exclude arteriosclerosis   |
| 8  | <input type="checkbox"/> | Vasculitis             | Ulceration, gangrene, tender finger nodules, periungual, infarction, splinter hemorrhages, or biopsy or angiogram proof of vasculitis  |
| 4  | <input type="checkbox"/> | Arthritis              | More than 2 joints with pain and signs of inflammation (i.e. tenderness, swelling, or effusion).   |
| 4  | <input type="checkbox"/> | Myositis               | Proximal muscle aching/weakness, associated with elevated creatine phosphokinase/aldolase or electromyogram changes or a biopsy showing myositis.  |
| 4  | <input type="checkbox"/> | Urinary Casts          | Heme-granular or red blood cell casts  |
| 4  | <input type="checkbox"/> | Hematuria              | >5 red blood cells/high power field. Exclude stone, infection or other cause.  |
| 4  | <input type="checkbox"/> | Proteinuria            | >0.5 gm/24 hours. New onset or recent increase of more than 0.5 gm/24 hours.   |
| 4  | <input type="checkbox"/> | Pyuria                 | >5 white blood cells/high power field. Exclude infection.  |
| 2  | <input type="checkbox"/> | New Rash               | New onset or recurrence of inflammatory type rash.   |
| 2  | <input type="checkbox"/> | Alopecia               | New onset or recurrence of abnormal, patchy or diffuse loss of hair.   |
| 2  | <input type="checkbox"/> | Mucosal Ulcers         | New onset or recurrence of oral or nasal ulcerations   |

FIG. 1B

|   |                          |                       |  |
|---|--------------------------|-----------------------|--|
| 2 | <input type="checkbox"/> | Pleurisy              | Pleuritic chest pain with pleural rub or effusion, or pleural thickening.                            |
| 2 | <input type="checkbox"/> | Pericarditis          | Pericardial pain with at least 1 of the following: rub, effusion, or electrocardiogram confirmation. |
| 2 | <input type="checkbox"/> | Low Complement        | Decrease in CH50, C3, or C4 below the lower limit of normal for testing laboratory.                  |
| 2 | <input type="checkbox"/> | Increased DNA binding | >25% binding by Farr assay or above normal range for testing laboratory.                             |
| 1 | <input type="checkbox"/> | Fever                 | >38°C. Exclude infectious cause  |
| 1 | <input type="checkbox"/> | Thrombocytopenia      | <100,000 platelets/mm <sup>3</sup>   |
| 1 | <input type="checkbox"/> | Leukopenia            | <3,000 White blood cell/mm <sup>3</sup> . Exclude drug causes.                                       |

\_\_\_\_\_ TOTAL SCORE (Sum of weights next to descriptors marked present)

| Mild or Moderate Flare <input type="checkbox"/>  | Severe Flare <input type="checkbox"/>   |
|--|---|
| <input type="checkbox"/> Change in SLEDAI > 3 points   | <input type="checkbox"/> Change in SLEDAI > 12  |
| <input type="checkbox"/> New/worse discoid, photosensitive, profundus, cutaneous vasculitis, bullous lupus<br>Nasopharyngeal ulcers<br>Pleuritis<br>Pericarditis<br>Arthritis<br>Fever (SLE) | <input type="checkbox"/> New/worse CNS-SLE<br>Vasculus<br>Nephritis<br>Myositis<br>Pk < 60,000<br>Heme anemia: Hb <7% or decrease in Hb > 3%<br>Requiring: double prednisone<br>Prednisone >0.5 mg/kg/day hospitalization |
| <input type="checkbox"/> Increase in Prednisone, but not to >0.5 mg/kg/day   | <input type="checkbox"/> Prednisone >0.5 mg/kg/day  |
| <input type="checkbox"/> Added NSAID or Plaquenil  | <input type="checkbox"/> New Cycloan, Azathioprine, Methotrexate, Hospitalization (SLE)   |
| <input type="checkbox"/> ≥1.0 Increase in PGA, but not to more than 2.5  | <input type="checkbox"/> Increase in PGA to > 2.5   |

FIG. 2

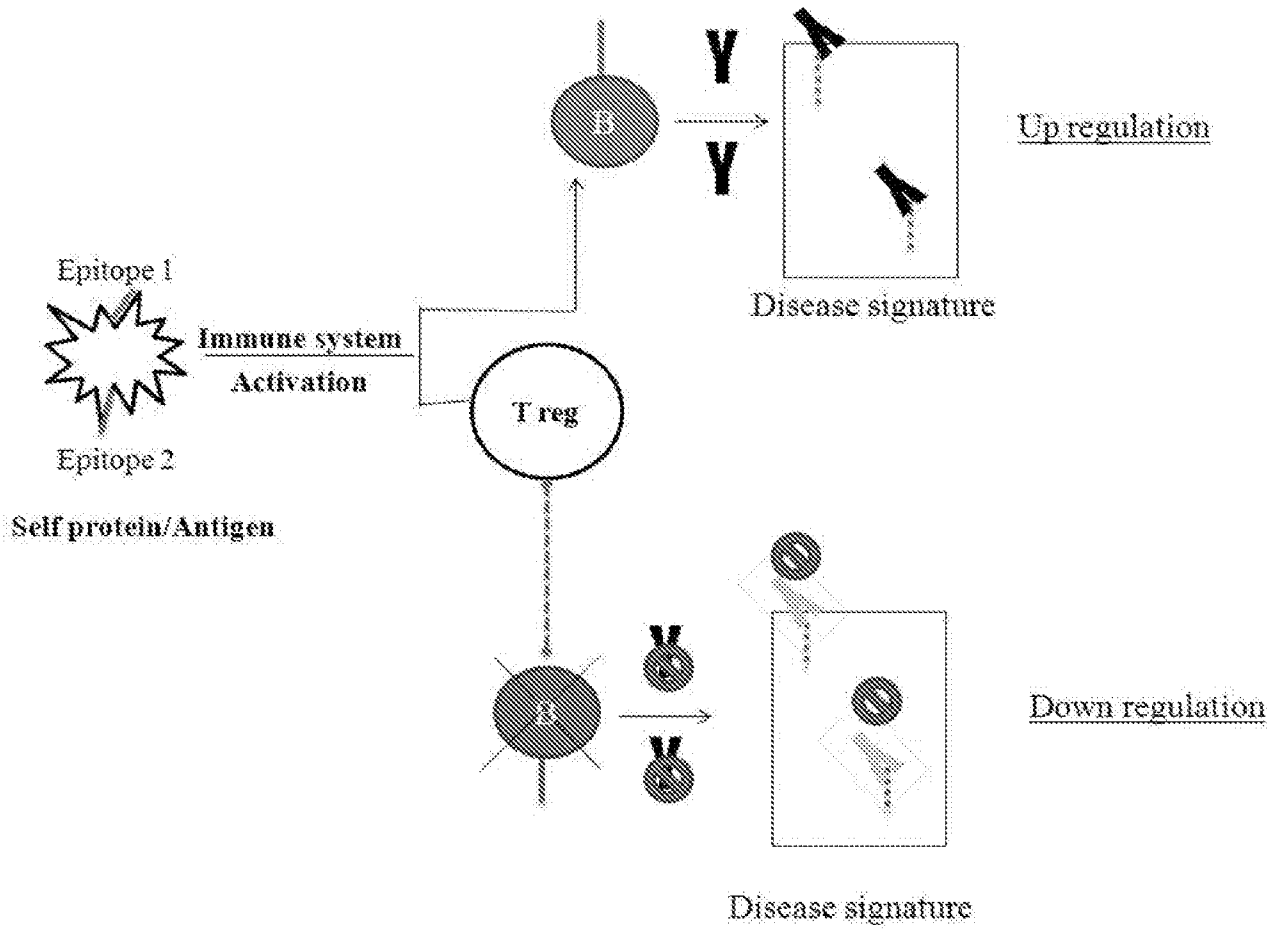
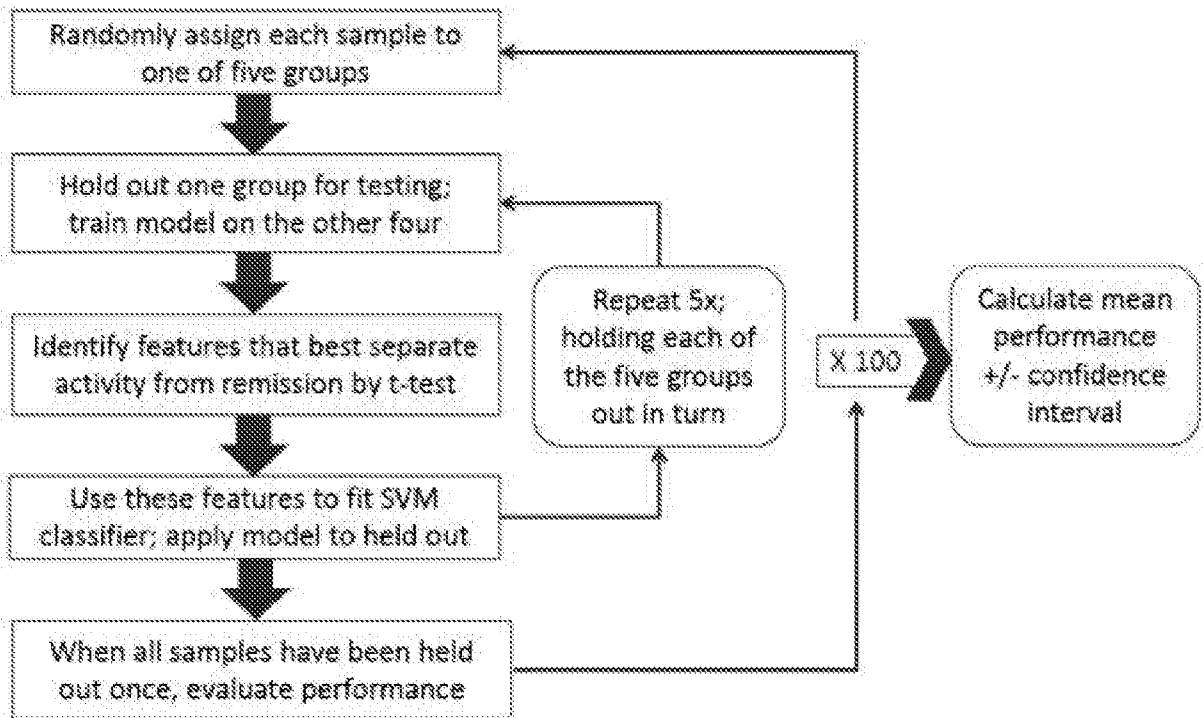

FIG. 3



the classifier model is only tested on samples not used in training

FIG. 4

Peptides that Distinguish Active vs. Inactive SLE

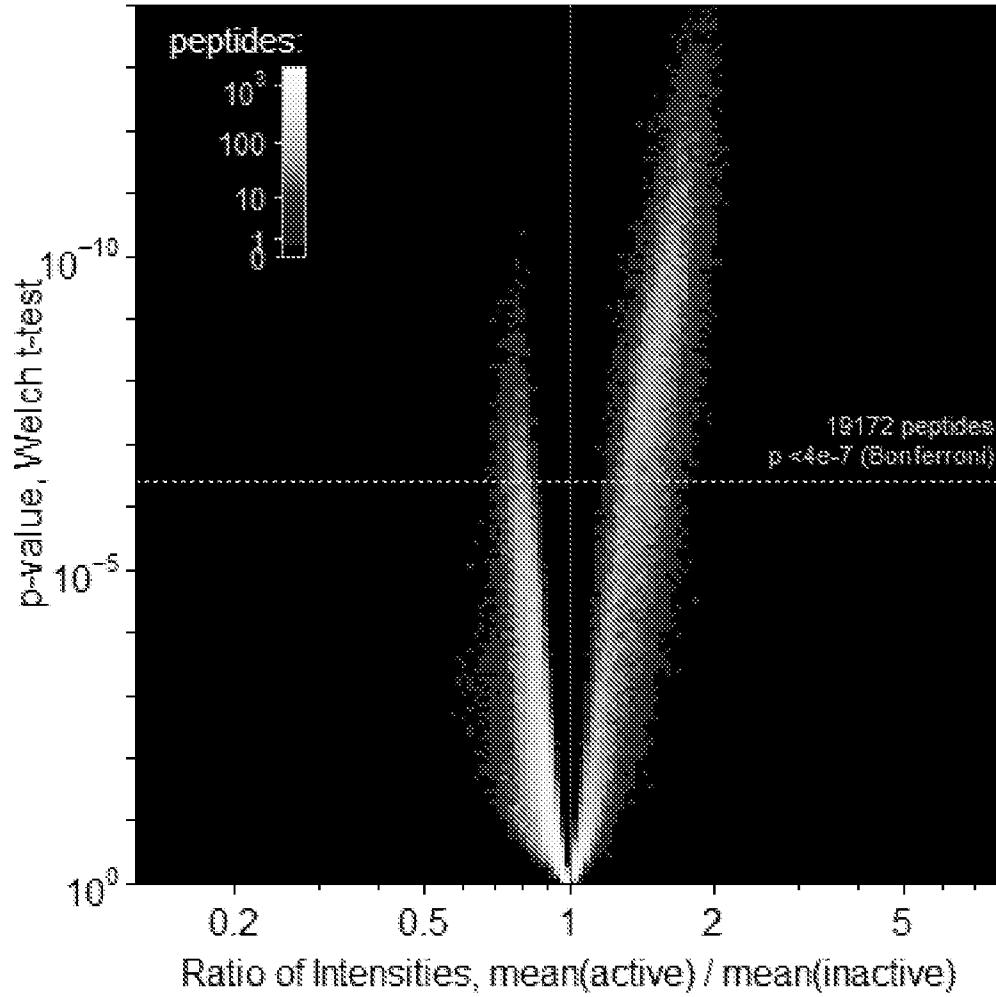

FIG. 5

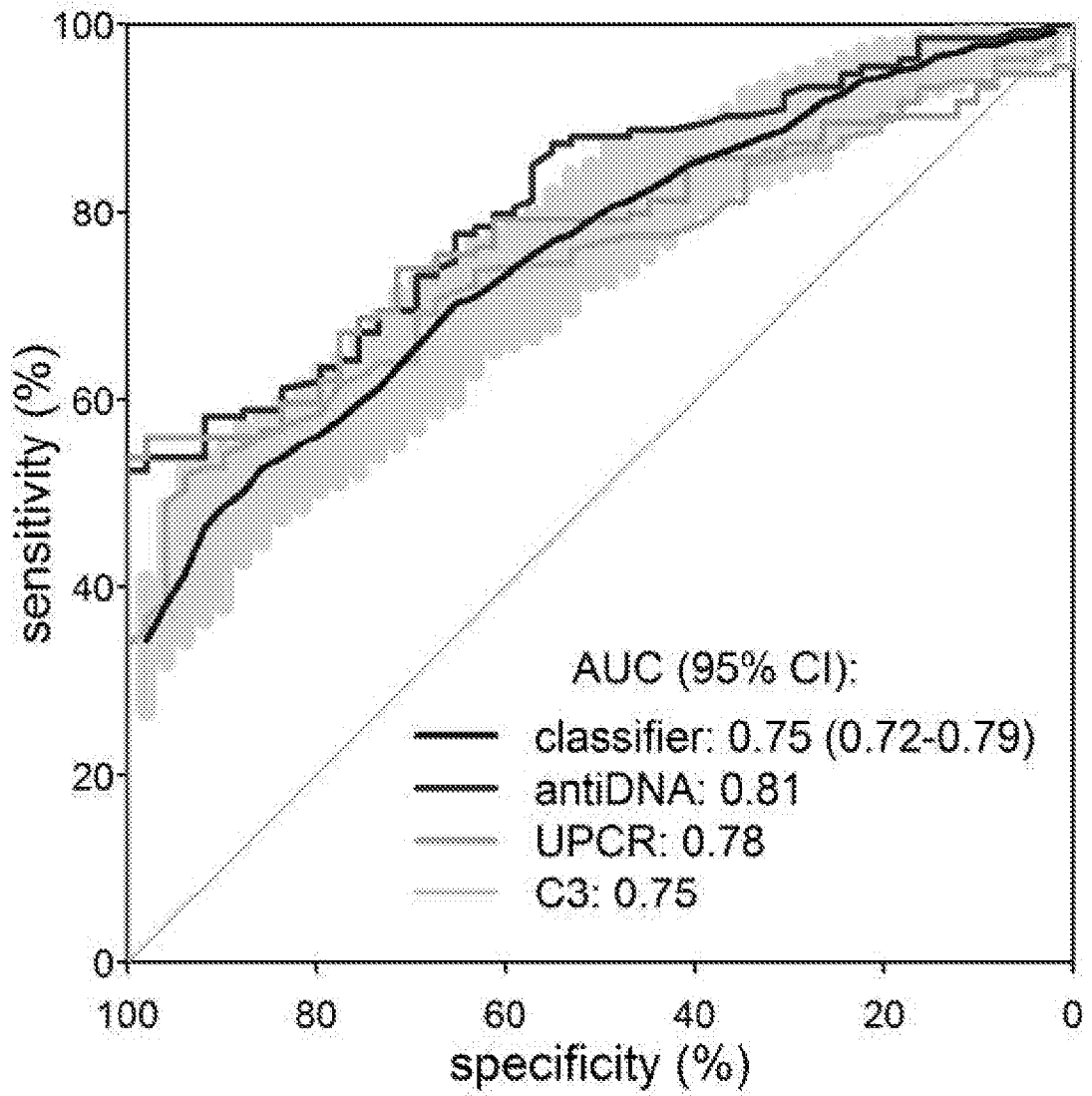
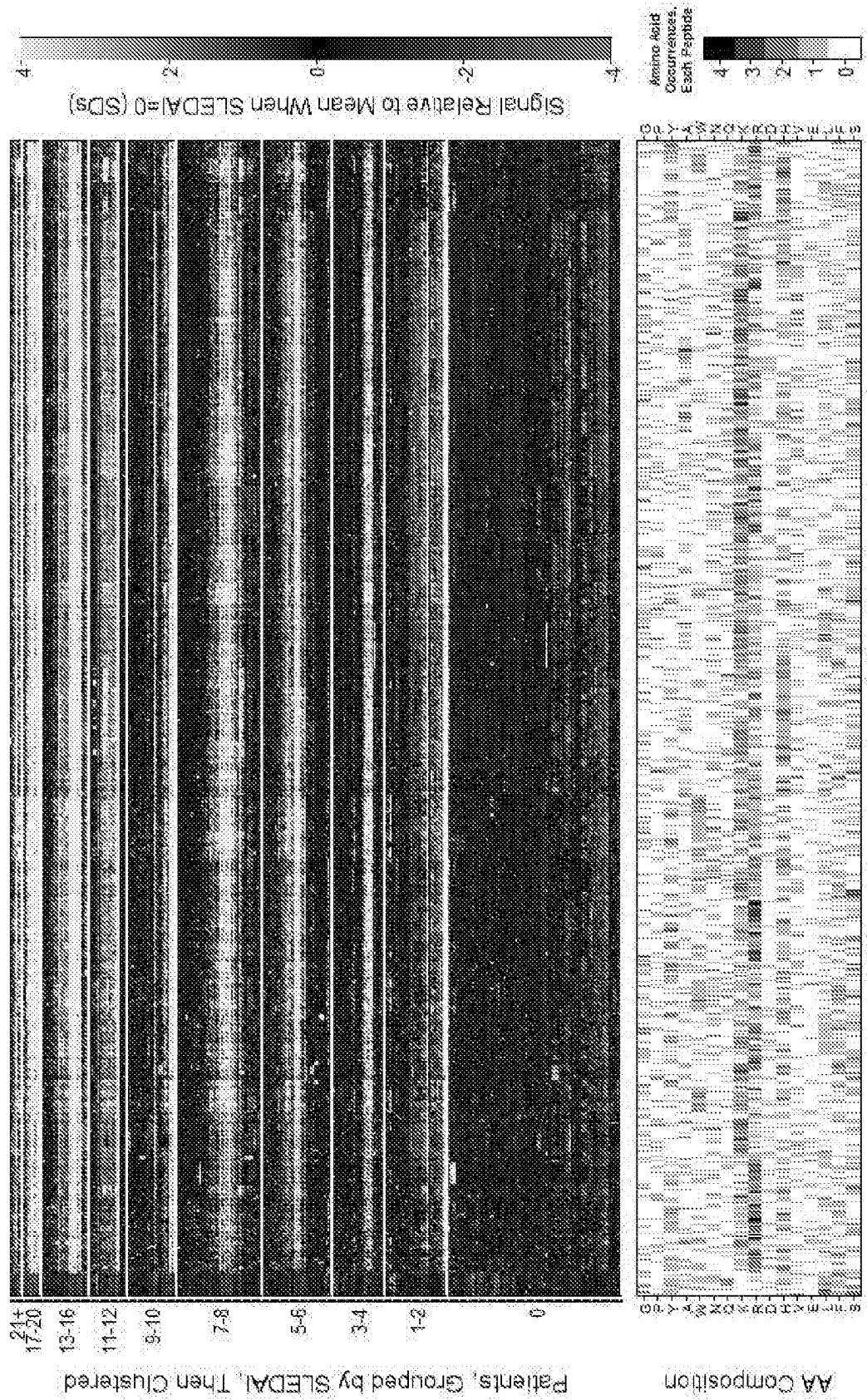

FIG. 6



Top 702 Peptides Associated with SLEDAI, Clustered



FIG. 8

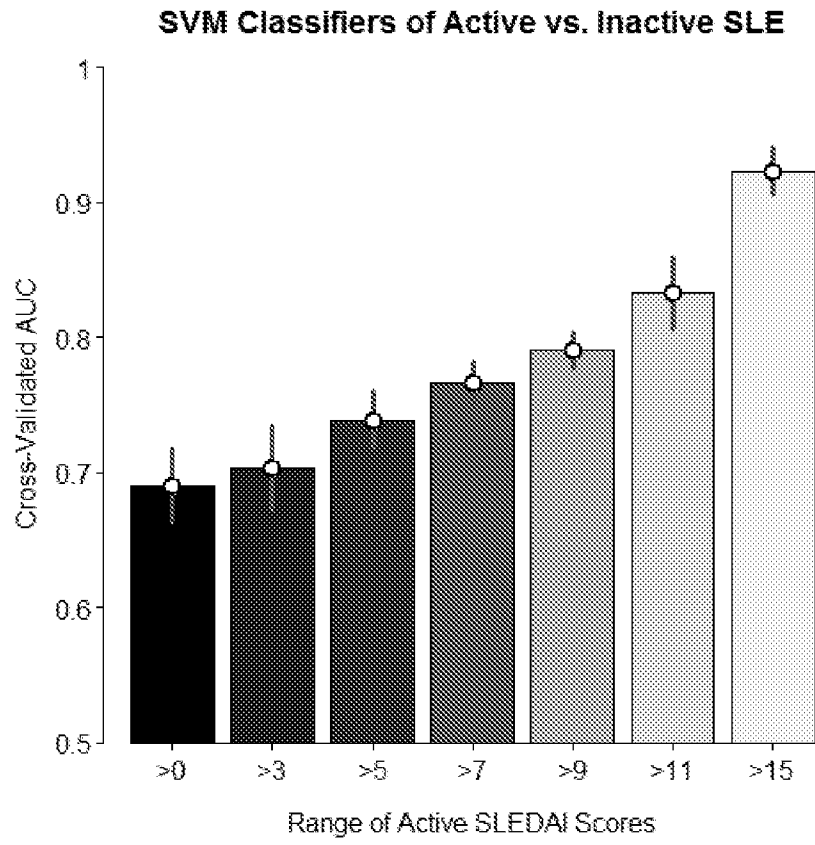
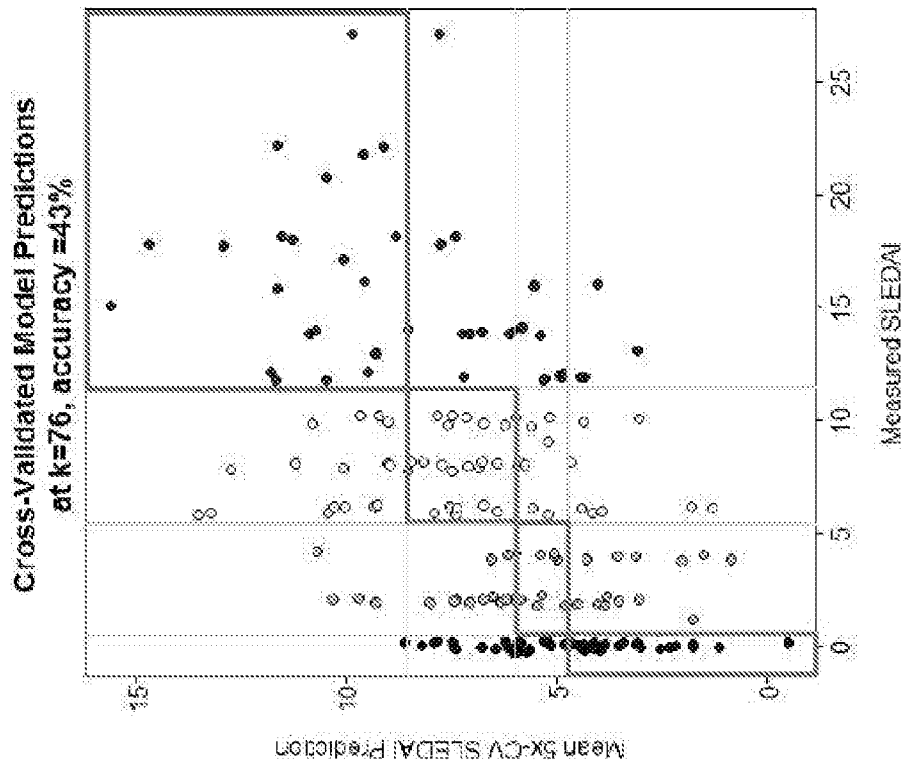

FIG. 9



Fraction of Each Activity Level Predicted Correctly:

| True Activity | Activity Predicted by IMS Model |      |          |        |
|---------------|---------------------------------|------|----------|--------|
|               | remission                       | mild | moderate | severe |
| severe        | 9%                              | 19%  | 21%      | 51%    |
| moderate      | 15%                             | 15%  | 41%      | 30%    |
| mild          | 35%                             | 24%  | 30%      | 11%    |
| remission     | 51%                             | 24%  | 22%      | 2%     |

|           | accuracy | correlation ( $r^2$ ) |
|-----------|----------|-----------------------|
| IMS model | 43%      | 0.22                  |
| antiDNA   | 43%      | 0.13                  |
| C3        | 15%      | 0.16                  |
| C4        | 21%      | 0.11                  |
| UPCR      | 41%      | 0.24                  |

11/20

FIG. 10

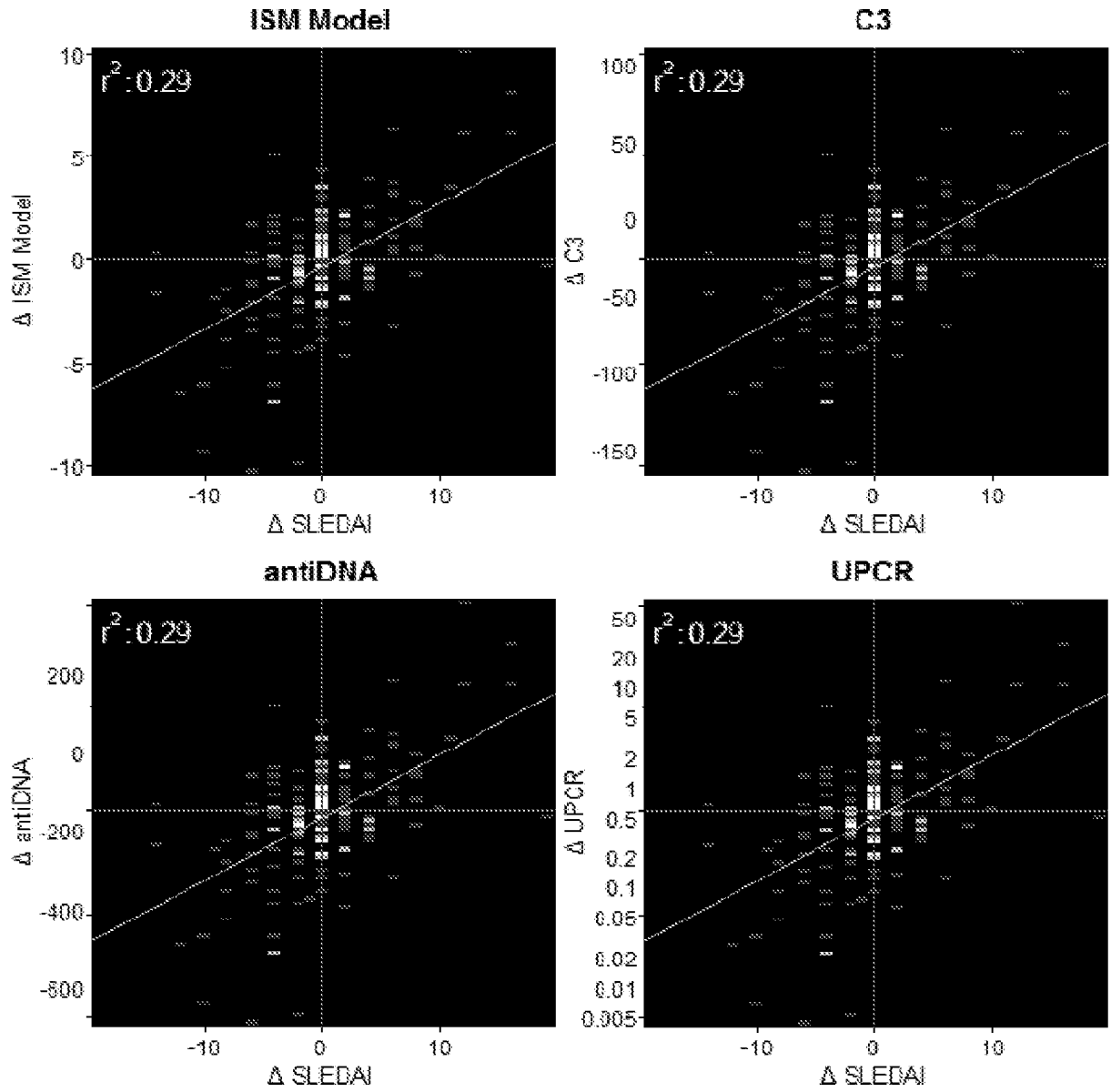

FIG. 11

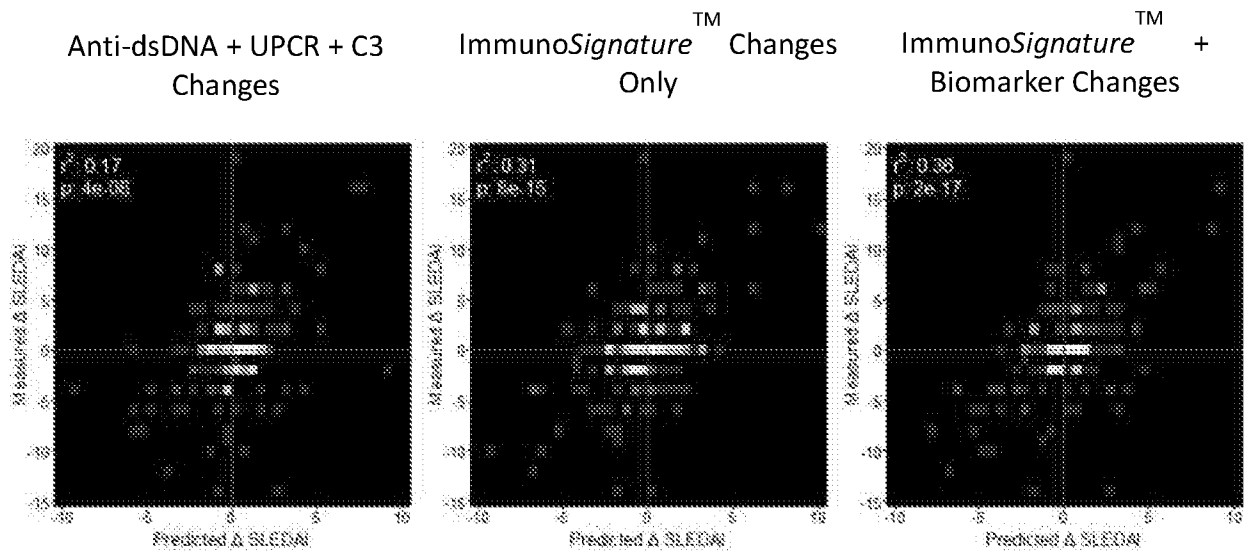
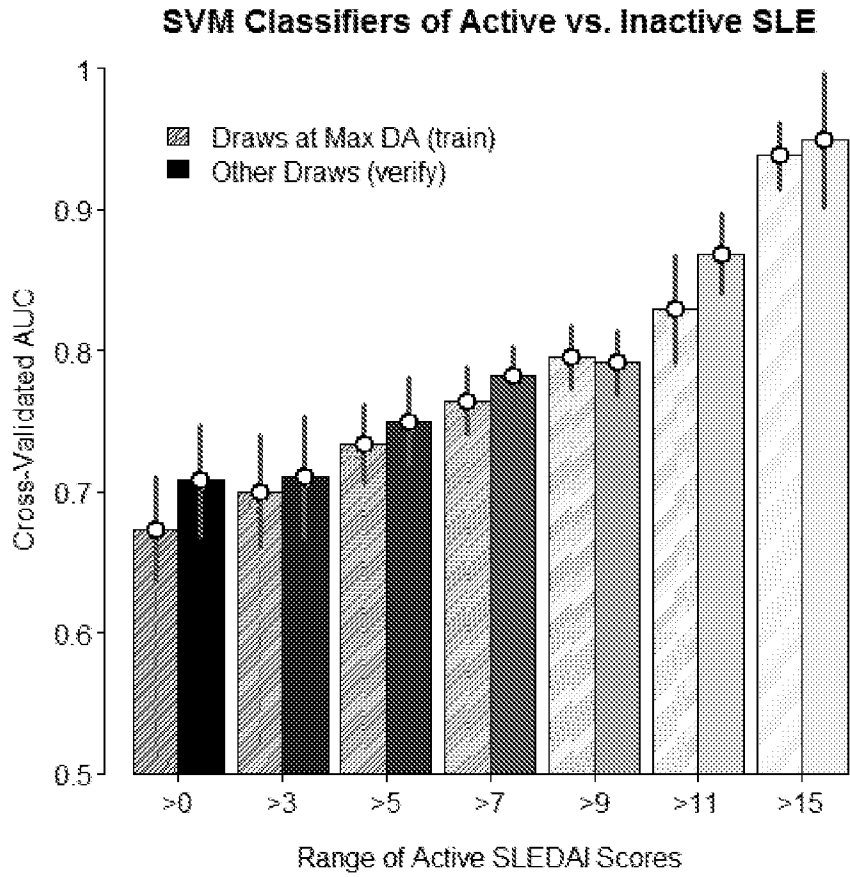

FIG. 12



| SLEDAI | 0  | 1-3 | 4-5 | 6-7 | 8-9 | 10-11 | 12-15 | 15-27 |
|--------|----|-----|-----|-----|-----|-------|-------|-------|
| first  | 49 | 23  | 14  | 20  | 19  | 15    | 25    | 18    |
| later  | 53 | 13  | 17  | 20  | 32  | 13    | 14    | 11    |

FIG. 13A

| motif   | n   | n.lib | enrich     | p         | fdr       | padj.holm | Pr_seqs.motif | PLR        |
|---------|-----|-------|------------|-----------|-----------|-----------|---------------|------------|
| K       | 850 | 62082 | 2.52962046 | 1.41E-145 | 5.63E-145 | 5.63E-145 | 0.01369157    | 2.47787105 |
| R       | 795 | 63785 | 2.30277077 | 6.62E-115 | 1.32E-114 | 1.99E-114 | 0.01246375    | 2.2528576  |
| HK      | 84  | 2524  | 6.10780767 | 1.55E-38  | 1.41E-36  | 1.41E-36  | 0.03328051    | 6.14508197 |
| R.K     | 87  | 2758  | 5.81149826 | 2.52E-38  | 2.37E-36  | 2.37E-36  | 0.0315446     | 5.81411456 |
| RR      | 81  | 2464  | 6.03308901 | 7.65E-37  | 3.29E-35  | 6.89E-35  | 0.03287338    | 6.06735208 |
| KK      | 79  | 2345  | 6.18272118 | 1.08E-36  | 3.29E-35  | 9.65E-35  | 0.0336887     | 6.22308032 |
| KR      | 123 | 5930  | 3.80667531 | 2.43E-35  | 5.53E-34  | 2.14E-33  | 0.02074199    | 3.78086792 |
| HR      | 77  | 2470  | 5.72122713 | 1.37E-33  | 2.49E-32  | 1.19E-31  | 0.03117409    | 5.74362725 |
| RH      | 122 | 6470  | 3.46059653 | 2.54E-31  | 3.86E-30  | 2.19E-29  | 0.01885626    | 3.4305293  |
| H       | 563 | 65939 | 1.57749568 | 3.36E-31  | 4.47E-31  | 6.71E-31  | 0.00853819    | 1.53719255 |
| K..K    | 73  | 2501  | 5.47277836 | 1.55E-30  | 1.43E-28  | 1.43E-28  | 0.02918832    | 5.36676277 |
| RG      | 98  | 4727  | 3.80488555 | 2.05E-28  | 2.66E-27  | 1.74E-26  | 0.02073197    | 3.77900194 |
| R.R     | 73  | 2789  | 4.82211393 | 1.74E-27  | 3.20E-26  | 1.62E-25  | 0.02617426    | 4.79768041 |
| K.K     | 71  | 2686  | 4.86984863 | 5.09E-27  | 1.47E-25  | 4.68E-25  | 0.02643336    | 4.84646272 |
| K.R     | 73  | 2850  | 4.71890378 | 6.26E-27  | 1.47E-25  | 5.70E-25  | 0.02561404    | 4.69229384 |
| H.K     | 71  | 2779  | 4.7068778  | 3.60E-26  | 6.77E-25  | 3.24E-24  | 0.02554876    | 4.68002216 |
| K..G    | 99  | 5512  | 3.36763238 | 1.27E-24  | 4.50E-23  | 1.15E-22  | 0.01796081    | 3.26464068 |
| R..K    | 64  | 2434  | 4.93012683 | 1.47E-24  | 4.50E-23  | 1.32E-22  | 0.02629417    | 4.82025316 |
| R...R   | 57  | 1942  | 5.52507679 | 1.66E-24  | 1.41E-22  | 1.41E-22  | 0.02935118    | 5.39761273 |
| K....G  | 78  | 3846  | 3.78255433 | 3.62E-24  | 3.08E-22  | 3.08E-22  | 0.02028081    | 3.69506369 |
| H.R     | 68  | 2810  | 4.45826331 | 7.61E-24  | 1.19E-22  | 6.77E-22  | 0.02419929    | 4.42669584 |
| KG      | 85  | 4297  | 3.63035412 | 1.53E-23  | 1.74E-22  | 1.29E-21  | 0.01978124    | 3.60220798 |
| KH      | 98  | 5687  | 3.1625563  | 1.10E-22  | 1.04E-21  | 9.15E-21  | 0.01723228    | 3.12989801 |
| KK      | 63  | 2534  | 4.56277818 | 1.14E-22  | 1.04E-21  | 9.37E-21  | 0.02486188    | 4.5509915  |
| K...K   | 47  | 1441  | 6.11926437 | 1.43E-22  | 1.32E-20  | 1.32E-20  | 0.03261624    | 6.01829268 |
| K.G     | 107 | 6718  | 2.93431612 | 2.48E-22  | 3.33E-21  | 2.18E-20  | 0.01592736    | 2.88904856 |
| R.H     | 65  | 2863  | 4.18268472 | 1.92E-21  | 2.26E-20  | 1.67E-19  | 0.02270346    | 4.14671194 |
| K...G   | 88  | 5075  | 3.26406887 | 2.14E-21  | 9.08E-20  | 1.79E-19  | 0.0173399     | 3.14978945 |
| R..R    | 60  | 2521  | 4.46248836 | 4.94E-21  | 1.14E-19  | 4.40E-19  | 0.02380008    | 4.35188948 |
| K..R    | 60  | 2593  | 4.33857815 | 1.88E-20  | 3.45E-19  | 1.65E-18  | 0.02313922    | 4.22818792 |
| H..K    | 57  | 2392  | 4.46799185 | 4.43E-20  | 6.79E-19  | 3.85E-18  | 0.02382943    | 4.35738758 |
| K....G  | 75  | 4409  | 3.19143868 | 2.18E-18  | 1.00E-16  | 1.98E-16  | 0.01701066    | 3.08894785 |
| R....G  | 75  | 4448  | 3.16345619 | 3.48E-18  | 1.07E-16  | 3.13E-16  | 0.01686151    | 3.0613995  |
| K...R   | 49  | 1997  | 4.61881645 | 3.79E-18  | 1.07E-16  | 3.14E-16  | 0.02453681    | 4.48998973 |
| R.....G | 69  | 3967  | 3.24404405 | 4.38E-18  | 1.86E-16  | 3.68E-16  | 0.0173935     | 3.15969728 |
| R...K   | 47  | 1862  | 4.75150149 | 6.19E-18  | 1.32E-16  | 5.08E-16  | 0.02524168    | 4.62231405 |
| R.G     | 99  | 7019  | 2.59850211 | 2.49E-17  | 2.60E-16  | 2.14E-15  | 0.01410457    | 2.55368497 |

FIG. 13B

| motif   | n   | n.lib  | enrich     | p        | fdr      | padj.holm | Pr_seqs.motif | PIR        |
|---------|-----|--------|------------|----------|----------|-----------|---------------|------------|
| R...G   | 81  | 5272   | 2.88076816 | 1.40E-16 | 1.84E-15 | 1.21E-14  | 0.01536419    | 2.78530148 |
| R...H   | 54  | 2660   | 3.80636836 | 3.40E-16 | 3.91E-15 | 2.89E-14  | 0.02030075    | 3.69877206 |
| H...R   | 46  | 2001   | 4.32736404 | 4.29E-16 | 7.29E-15 | 3.48E-14  | 0.02298851    | 4.2        |
| R....K  | 39  | 1480   | 4.94388353 | 6.07E-16 | 1.40E-14 | 5.40E-14  | 0.02635135    | 4.83102012 |
| H.....G | 64  | 3962   | 3.01278588 | 2.13E-15 | 6.03E-14 | 1.77E-13  | 0.01615346    | 2.93073371 |
| K...K   | 43  | 1839   | 4.40148691 | 2.16E-15 | 3.05E-14 | 1.72E-13  | 0.02338227    | 4.2736637  |
| H....R  | 38  | 1485   | 4.80089804 | 3.55E-15 | 6.53E-14 | 3.12E-13  | 0.02558923    | 4.68762958 |
| H...R   | 50  | 2513   | 3.73057871 | 8.88E-15 | 9.08E-14 | 7.46E-13  | 0.01989654    | 3.62382972 |
| HKR     | 18  | 264    | 7.33710284 | 1.27E-14 | 9.47E-12 | 9.47E-12  | 0.06818182    | 13.0609756 |
| R...G   | 74  | 5064   | 2.7507474  | 1.91E-14 | 2.32E-13 | 1.51E-12  | 0.01461295    | 2.64709419 |
| H....K  | 28  | 878    | 5.94789602 | 4.62E-14 | 9.82E-13 | 3.79E-12  | 0.03189066    | 5.88       |
| G       | 723 | 111145 | 1.20185066 | 6.07E-14 | 6.07E-14 | 6.07E-14  | 0.00650502    | 1.16874808 |
| R....K  | 28  | 910    | 5.73873924 | 1.09E-13 | 1.86E-12 | 8.85E-12  | 0.03076923    | 5.66666667 |
| KRG     | 22  | 504    | 4.69729864 | 1.44E-13 | 4.30E-11 | 1.08E-10  | 0.04365079    | 8.1473029  |
| RHK     | 15  | 186    | 8.67829368 | 1.73E-13 | 4.30E-11 | 1.29E-10  | 0.08064516    | 15.6578947 |
| K....R  | 36  | 1536   | 4.3972041  | 2.38E-13 | 3.66E-12 | 2.07E-11  | 0.0234375     | 4.284      |
| RRH     | 17  | 278    | 6.58051909 | 3.98E-13 | 7.43E-11 | 2.96E-10  | 0.06115108    | 11.6264368 |
| K.H     | 53  | 3076   | 3.17433429 | 4.86E-13 | 4.57E-12 | 4.13E-11  | 0.01723017    | 3.12950711 |
| K....K  | 27  | 909    | 5.53987204 | 6.72E-13 | 9.52E-12 | 5.38E-11  | 0.02970297    | 5.46428571 |
| KHK     | 14  | 168    | 8.96757013 | 7.00E-13 | 1.03E-10 | 5.20E-10  | 0.08333333    | 16.2272727 |
| RHR     | 14  | 170    | 8.86206931 | 8.23E-13 | 1.03E-10 | 6.11E-10  | 0.08235294    | 16.0192308 |
| K.H     | 48  | 2694   | 3.34073739 | 1.47E-12 | 1.35E-11 | 1.22E-10  | 0.01781737    | 3.23809524 |
| R....R  | 28  | 1035   | 5.04565479 | 2.29E-12 | 2.78E-11 | 1.81E-10  | 0.02705314    | 4.9632572  |
| H...K   | 38  | 1855   | 3.85613626 | 4.41E-12 | 4.69E-11 | 3.44E-10  | 0.02048518    | 3.7330765  |
| KA      | 45  | 2500   | 3.30345141 | 7.87E-12 | 6.51E-11 | 6.38E-10  | 0.018         | 3.27189409 |
| R...R   | 34  | 1610   | 3.96203566 | 1.76E-11 | 2.31E-10 | 1.51E-09  | 0.02111801    | 3.85088832 |
| RRG     | 13  | 175    | 7.99394823 | 1.98E-11 | 2.11E-09 | 1.46E-08  | 0.07428571    | 14.3240741 |
| RY      | 46  | 2725   | 3.09803802 | 3.76E-11 | 2.85E-10 | 3.01E-09  | 0.01688073    | 3.06494961 |
| K...S   | 43  | 2579   | 3.12811314 | 7.22E-11 | 8.30E-10 | 6.13E-09  | 0.01667313    | 3.02661672 |
| K...W   | 34  | 1684   | 3.80057685 | 8.37E-11 | 7.96E-10 | 6.44E-09  | 0.02019002    | 3.67818182 |
| H....K  | 31  | 1447   | 4.01937477 | 9.51E-11 | 9.72E-10 | 7.98E-09  | 0.02142364    | 3.90783898 |
| K.S     | 63  | 4726   | 2.4558959  | 1.52E-10 | 1.29E-09 | 1.27E-08  | 0.01333051    | 2.41164486 |
| R..Y    | 36  | 1963   | 3.43859393 | 4.06E-10 | 3.39E-09 | 3.33E-08  | 0.01833928    | 3.33471718 |
| KS      | 59  | 4482   | 2.41588122 | 1.08E-09 | 7.55E-09 | 6.52E-08  | 0.01316377    | 2.38107619 |
| HRG     | 11  | 159    | 7.4447752  | 1.47E-09 | 1.37E-07 | 1.09E-06  | 0.06918239    | 13.2668919 |
| RW      | 41  | 2540   | 2.96241268 | 1.50E-09 | 9.74E-09 | 1.17E-07  | 0.01614173    | 2.92857143 |
| R.S     | 61  | 4818   | 2.33252421 | 2.01E-09 | 1.58E-08 | 1.67E-07  | 0.01266086    | 2.28894261 |

FIG. 13C

| motif  | n  | n.lib | enrich     | p        | fdr      | padj.holm  | Pr_seqs.motif | FLR        |
|--------|----|-------|------------|----------|----------|------------|---------------|------------|
| K...N  | 37 | 2204  | 3.14766732 | 2.43E-09 | 1.86E-08 | 1.97E-07   | 0.01678766    | 3.04776188 |
| RKK    | 9  | 94    | 10.3031657 | 2.59E-09 | 2.15E-07 | 1.91E-06   | 0.09574468    | 18.9       |
| K...F  | 42 | 2764  | 2.86038137 | 2.76E-09 | 2.35E-08 | 2.10E-07   | 0.01519537    | 2.75422483 |
| YK     | 58 | 3988  | 2.43902436 | 5.75E-09 | 3.49E-08 | 4.43E-07   | 0.01328987    | 2.40419314 |
| H...G  | 61 | 5083  | 2.25903216 | 7.24E-09 | 5.60E-08 | 5.43E-07   | 0.01200079    | 2.1681601  |
| K.W    | 40 | 2598  | 2.8365077  | 7.34E-09 | 5.31E-08 | 6.02E-07   | 0.01539546    | 2.79124316 |
| R...H  | 35 | 2155  | 3.05726763 | 1.13E-08 | 8.04E-08 | 8.40E-07   | 0.0162413     | 2.94693396 |
| KGG    | 9  | 114   | 8.49559276 | 1.43E-08 | 1.07E-06 | 1.06E-05   | 0.07894737    | 15.3       |
| R....H | 29 | 1618  | 3.36267442 | 1.87E-08 | 1.72E-07 | 1.55E-06   | 0.01792336    | 3.25770925 |
| AK     | 54 | 4281  | 2.31496244 | 2.31E-08 | 1.32E-07 | 1.76E-06   | 0.01261388    | 2.28034067 |
| RYH    | 10 | 164   | 6.56163668 | 2.72E-08 | 1.85E-06 | 2.00E-05   | 0.06097561    | 11.5408091 |
| G...K  | 32 | 1931  | 3.11946698 | 3.01E-08 | 1.97E-07 | 2.19E-06   | 0.01657172    | 3.00789889 |
| K...S  | 48 | 3660  | 2.45900178 | 3.06E-08 | 2.17E-07 | 2.45E-06   | 0.01311475    | 2.37209302 |
| KV     | 63 | 5427  | 2.13047354 | 3.60E-08 | 1.93E-07 | 2.70E-06   | 0.01160862    | 2.09647651 |
| KF     | 57 | 4754  | 2.20044793 | 6.94E-08 | 3.51E-07 | 5.13E-06   | 0.01198899    | 2.1681699  |
| KA     | 8  | 99    | 6.69582558 | 7.59E-08 | 4.49E-06 | 5.59E-05   | 0.08080808    | 15.6923077 |
| L...K  | 26 | 1431  | 3.40878063 | 7.68E-08 | 6.42E-07 | 6.30E-06   | 0.01816911    | 3.30320285 |
| RHF    | 18 | 696   | 2.78303901 | 7.82E-08 | 4.49E-06 | 5.75E-05   | 0.02586207    | 4.73393825 |
| KRH    | 17 | 627   | 2.91767832 | 9.16E-08 | 4.89E-06 | 6.72E-05   | 0.02711324    | 4.97459016 |
| K....R | 21 | 1005  | 3.89720351 | 9.81E-08 | 1.04E-06 | 7.65E-06   | 0.02089552    | 3.80945122 |
| WK     | 56 | 4685  | 2.1936829  | 9.88E-08 | 4.73E-07 | 7.21E-06   | 0.01195304    | 2.15942968 |
| K.F    | 52 | 4274  | 2.24146493 | 1.27E-07 | 8.51E-07 | 1.03E-05   | 0.01216659    | 2.19848413 |
| KQ     | 35 | 2401  | 2.67529268 | 2.48E-07 | 1.13E-06 | 1.78E-05   | 0.01457726    | 2.64053254 |
| KHR    | 9  | 159   | 6.09117971 | 2.53E-07 | 1.26E-05 | 0.00018535 | 0.05660377    | 10.71      |
| K.Y    | 37 | 2649  | 2.57325537 | 2.79E-07 | 1.75E-06 | 2.23E-05   | 0.01396753    | 2.52852221 |
| HRK    | 7  | 80    | 9.41594864 | 2.88E-07 | 1.34E-05 | 0.00021086 | 0.0875        | 17.1164384 |
| GK     | 41 | 3075  | 2.44700104 | 3.10E-07 | 1.34E-06 | 2.20E-05   | 0.01333333    | 2.41216216 |
| R.F    | 51 | 4316  | 2.17696708 | 3.22E-07 | 1.89E-06 | 2.54E-05   | 0.0118165     | 2.13446659 |
| HKN    | 7  | 82    | 9.18629136 | 3.42E-07 | 1.50E-05 | 0.00024965 | 0.08536585    | 16.66      |
| H....R | 20 | 994   | 3.75269669 | 3.53E-07 | 3.33E-06 | 2.71E-05   | 0.02012072    | 3.66529774 |
| K.L    | 47 | 3853  | 2.24730475 | 3.82E-07 | 2.11E-06 | 2.98E-05   | 0.01219829    | 2.20426271 |
| G...K  | 34 | 2370  | 2.68985743 | 3.94E-07 | 2.59E-06 | 3.12E-05   | 0.01434599    | 2.59803082 |
| NK     | 58 | 5166  | 2.06048287 | 4.30E-07 | 1.78E-06 | 3.01E-05   | 0.01122726    | 2.02682087 |
| GR     | 39 | 2888  | 2.47835112 | 5.22E-07 | 2.07E-06 | 3.60E-05   | 0.01350416    | 2.44348894 |
| KRR    | 9  | 174   | 5.56607801 | 5.40E-07 | 2.24E-05 | 0.00039452 | 0.05172414    | 9.73636364 |
| RKA    | 7  | 92    | 8.18778143 | 7.51E-07 | 2.95E-05 | 0.00054749 | 0.07608696    | 14.7       |
| H...G  | 50 | 4443  | 2.11134416 | 7.88E-07 | 6.04E-06 | 6.38E-05   | 0.01125366    | 2.03164125 |

FIG. 13D

| motif | n  | n.lib | enrich     | p        | fdr        | padj.holm  | Pr_seqs.motif | FLR        |
|-------|----|-------|------------|----------|------------|------------|---------------|------------|
| HKK   | 7  | 97    | 7.76573084 | 1.08E-06 | 4.02E-05   | 0.00078319 | 0.07216495    | 13.8833333 |
| F...K | 29 | 1950  | 2.79947166 | 1.13E-06 | 6.84E-06   | 8.11E-05   | 0.01487179    | 2.69469027 |
| K.V   | 43 | 3538  | 2.23910133 | 1.32E-06 | 6.92E-06   | 0.000102   | 0.01215376    | 2.19613734 |
| HKF   | 9  | 194   | 4.99225554 | 1.34E-06 | 4.75E-05   | 0.00097149 | 0.04689175    | 8.68378378 |
| R...N | 22 | 1259  | 3.27840264 | 1.40E-06 | 9.89E-06   | 0.0001118  | 0.01747419    | 3.17461601 |
| RHG   | 15 | 605   | 2.66803739 | 1.54E-06 | 5.22E-05   | 0.00111556 | 0.02479339    | 4.53813559 |
| K...Q | 27 | 1793  | 2.83462859 | 2.07E-06 | 1.13E-05   | 0.00014691 | 0.01505856    | 2.7290487  |
| R..F  | 40 | 3228  | 2.32340627 | 2.10E-06 | 1.22E-05   | 0.00016378 | 0.01239157    | 2.23964868 |
| Y..K  | 33 | 2446  | 2.5296252  | 2.12E-06 | 1.22E-05   | 0.00016378 | 0.01349141    | 2.44115209 |
| K...Y | 25 | 1582  | 2.97472085 | 2.13E-06 | 1.13E-05   | 0.00014899 | 0.01580278    | 2.86608863 |
| GRG   | 9  | 238   | 4.65623834 | 2.37E-06 | 7.70E-05   | 0.00171804 | 0.04326923    | 8.07286432 |
| KKH   | 10 | 268   | 4.01532991 | 2.49E-06 | 7.75E-05   | 0.00180267 | 0.03731343    | 6.91860465 |
| QRKK  | 3  | 6     | 8.36593216 | 3.00E-06 | 0.00034723 | 0.00079684 | 0.5           | 178.5      |
| RRGS  | 3  | 6     | 8.36593216 | 3.00E-06 | 0.00034723 | 0.00079684 | 0.5           | 178.5      |
| K.A   | 35 | 2677  | 2.40870046 | 3.02E-06 | 1.45E-05   | 0.00022955 | 0.01307434    | 2.36468584 |
| K.N   | 35 | 2681  | 2.40510672 | 3.09E-06 | 1.45E-05   | 0.00023163 | 0.01305483    | 2.36111111 |
| RKV   | 9  | 219   | 4.42236335 | 3.61E-06 | 0.00010777 | 0.0026077  | 0.04109589    | 7.65       |
| H...H | 29 | 2080  | 2.62450468 | 3.86E-06 | 1.93E-05   | 0.00026629 | 0.01394231    | 2.52389078 |
| H..N  | 30 | 2175  | 2.58619153 | 3.95E-06 | 2.14E-05   | 0.00030035 | 0.0137931     | 2.4965035  |
| KKR   | 10 | 283   | 3.80250324 | 4.03E-06 | 0.00011248 | 0.00290873 | 0.03533569    | 6.53846154 |
| A.K   | 38 | 3043  | 2.30061934 | 4.06E-06 | 1.74E-05   | 0.00030017 | 0.01248768    | 2.25723794 |
| RKF   | 8  | 167   | 5.15501038 | 4.07E-06 | 0.00011248 | 0.0029312  | 0.04790419    | 8.98113208 |
| K.P   | 34 | 2593  | 2.41568066 | 4.08E-06 | 1.74E-05   | 0.00030017 | 0.01311323    | 2.37162954 |
| RN    | 33 | 2474  | 2.44799013 | 5.05E-06 | 1.91E-05   | 0.00034311 | 0.01333872    | 2.41315035 |
| Y.K   | 38 | 3099  | 2.25904635 | 5.07E-06 | 2.07E-05   | 0.00036486 | 0.01226202    | 2.2159425  |
| S...R | 23 | 1473  | 2.92947927 | 5.11E-06 | 3.28E-05   | 0.0004038  | 0.01561439    | 2.83137931 |
| HKRR  | 3  | 7     | 7.170799   | 5.22E-06 | 0.00034723 | 0.00137846 | 0.42857143    | 133.875    |
| HRLN  | 3  | 7     | 7.170799   | 5.22E-06 | 0.00034723 | 0.00137846 | 0.42857143    | 133.875    |
| K...L | 28 | 2033  | 2.58396122 | 5.35E-06 | 3.28E-05   | 0.00041698 | 0.01377275    | 2.49276808 |
| K..V  | 30 | 2249  | 2.51098714 | 6.18E-06 | 2.92E-05   | 0.00042033 | 0.01333926    | 2.41324921 |
| KHG   | 13 | 515   | 2.71639018 | 6.18E-06 | 0.00016492 | 0.00445095 | 0.02524272    | 4.62250996 |
| K...H | 29 | 2141  | 2.54972897 | 6.61E-06 | 2.96E-05   | 0.00044266 | 0.01354507    | 2.45099432 |
| RRL   | 9  | 238   | 4.06931754 | 7.06E-06 | 0.0001318  | 0.00507456 | 0.03781513    | 7.01528384 |
| R...S | 37 | 3095  | 2.25036912 | 7.71E-06 | 3.21E-05   | 0.00050873 | 0.01195477    | 2.15974493 |
| S...K | 27 | 1933  | 2.62932699 | 7.92E-06 | 3.21E-05   | 0.00051502 | 0.01396793    | 2.52859391 |
| KRW   | 8  | 185   | 4.6534418  | 8.61E-06 | 0.00021442 | 0.0061828  | 0.04324324    | 8.06779661 |
| R..S  | 41 | 3586  | 2.13777929 | 8.90E-06 | 4.55E-05   | 0.00066731 | 0.01140156    | 2.05864979 |

FIG. 13E

| motif   | n  | n.lib | enrich     | p        | fdr        | padj.holm  | Pr_seqs.motif | PLR        |
|---------|----|-------|------------|----------|------------|------------|---------------|------------|
| R...N   | 25 | 1726  | 2.7285402  | 9.30E-06 | 3.59E-05   | 0.00059491 | 0.01448436    | 2.62345679 |
| R...L   | 27 | 2003  | 2.52899607 | 1.13E-05 | 6.53E-05   | 0.00087383 | 0.01347978    | 2.43901822 |
| KXW     | 6  | 92    | 7.01809836 | 1.14E-05 | 0.00026726 | 0.00820872 | 0.06521739    | 12.4534884 |
| VHR     | 6  | 92    | 7.01809836 | 1.14E-05 | 0.00026726 | 0.00820872 | 0.06521739    | 12.4534884 |
| KVHR    | 3  | 9     | 5.57728811 | 1.24E-05 | 0.00066135 | 0.00325705 | 0.33333333    | 89.25      |
| K.....S | 28 | 2183  | 2.3922367  | 1.25E-05 | 0.00010588 | 0.00094671 | 0.01282639    | 2.31925754 |
| QK      | 56 | 5559  | 1.84879654 | 1.38E-05 | 4.66E-05   | 0.00085698 | 0.01007375    | 1.81646375 |
| RRK     | 6  | 97    | 6.65634072 | 1.55E-05 | 0.00035103 | 0.01108761 | 0.06185567    | 11.7692308 |
| K..F    | 38 | 3306  | 2.15515961 | 1.79E-05 | 8.68E-05   | 0.00132605 | 0.01149425    | 2.0755814  |
| RRF     | 8  | 206   | 4.17906181 | 1.87E-05 | 0.00041053 | 0.01336937 | 0.03883495    | 7.21212121 |
| AKA     | 7  | 150   | 5.02183927 | 1.92E-05 | 0.00041053 | 0.01371472 | 0.04666667    | 8.73776224 |
| R.....F | 24 | 1758  | 2.5461983  | 1.93E-05 | 0.00014948 | 0.00145085 | 0.01365188    | 2.47058824 |
| RKS     | 7  | 155   | 4.85984446 | 2.38E-05 | 0.00049285 | 0.01691121 | 0.04516129    | 8.44256757 |
| Y...K   | 26 | 1945  | 2.51632325 | 2.40E-05 | 8.88E-05   | 0.00151425 | 0.01336761    | 2.41844711 |
| KKWR    | 3  | 11    | 4.56323572 | 2.42E-05 | 0.00080546 | 0.00632254 | 0.27272727    | 66.9375    |
| RHRG    | 3  | 11    | 4.56323572 | 2.42E-05 | 0.00080546 | 0.00632254 | 0.27272727    | 66.9375    |
| RRHY    | 3  | 11    | 4.56323572 | 2.42E-05 | 0.00080546 | 0.00632254 | 0.27272727    | 66.9375    |
| HRH     | 9  | 279   | 3.47131747 | 2.48E-05 | 0.00050101 | 0.0176439  | 0.03225806    | 5.95       |
| R...V   | 29 | 2283  | 2.39113874 | 2.68E-05 | 9.49E-05   | 0.00166196 | 0.01370258    | 2.29658385 |
| KRWHF   | 2  | 2     | 1.567276   | 2.79E-05 | 3.72E-05   | 0.00011173 | 1             | inf        |
| LWKHG   | 2  | 2     | 1.567276   | 2.79E-05 | 3.72E-05   | 0.00011173 | 1             | inf        |
| WKHRG   | 2  | 2     | 1.567276   | 2.79E-05 | 3.72E-05   | 0.00011173 | 1             | inf        |
| KRK     | 7  | 160   | 4.70797432 | 2.91E-05 | 0.00055752 | 0.02066625 | 0.04375       | 8.16666667 |
| YYK     | 7  | 160   | 4.70797432 | 2.91E-05 | 0.00055752 | 0.02066625 | 0.04375       | 8.16666667 |
| K...H   | 23 | 1666  | 2.59010982 | 3.44E-05 | 0.0001836  | 0.00261139 | 0.01380552    | 2.49878271 |
| Y.R     | 37 | 3279  | 2.07885132 | 3.48E-05 | 0.00013629 | 0.00247053 | 0.01128393    | 2.03716841 |
| G...K   | 20 | 1334  | 2.81280422 | 3.59E-05 | 0.0001836  | 0.00269413 | 0.0149925     | 2.71689498 |
| SR      | 33 | 2763  | 2.19193904 | 3.61E-05 | 0.00012186 | 0.00238184 | 0.01194354    | 2.15769231 |
| KY      | 32 | 2610  | 2.2501159  | 3.62E-05 | 0.00012186 | 0.00238184 | 0.01226054    | 2.21567106 |
| RWK     | 8  | 227   | 3.79245257 | 3.73E-05 | 0.00068678 | 0.02644117 | 0.03524229    | 6.52054795 |
| KVS     | 13 | 613   | 2.28212225 | 3.77E-05 | 0.00068678 | 0.0266501  | 0.02120718    | 3.8675     |
| KN      | 30 | 2422  | 2.27322557 | 3.84E-05 | 0.00012467 | 0.00245496 | 0.01238646    | 2.23871237 |
| F..K    | 29 | 2332  | 2.33167568 | 4.05E-05 | 0.00017814 | 0.00295286 | 0.01243568    | 2.24772036 |
| HG      | 52 | 5251  | 1.81742603 | 4.06E-05 | 0.00012734 | 0.00255654 | 0.00990288    | 1.78534334 |
| K..V    | 33 | 2821  | 2.19335811 | 4.07E-05 | 0.00017814 | 0.00295286 | 0.01169798    | 2.11380488 |
| R...A   | 18 | 1132  | 2.98326215 | 4.14E-05 | 0.00020027 | 0.00306066 | 0.01590106    | 2.88420108 |
| AKAK    | 3  | 13    | 3.86119946 | 4.17E-05 | 0.00123111 | 0.01074679 | 0.23076923    | 53.55      |

FIG. 13F

| motif   | n  | n.lib | enrich     | p          | fdr        | padj.holm  | Pr_seqs.motif | PLR        |
|---------|----|-------|------------|------------|------------|------------|---------------|------------|
| RNK     | 8  | 231   | 3.72678239 | 4.22E-05   | 0.00075122 | 0.02981958 | 0.03463203    | 6.40358744 |
| KL      | 50 | 5031  | 1.82394234 | 6.00E-05   | 0.00018191 | 0.00371816 | 0.00993838    | 1.79180687 |
| R....H  | 18 | 1200  | 2.79763538 | 6.45E-05   | 0.00045723 | 0.00477667 | 0.015         | 2.71827411 |
| RHKL    | 3  | 15    | 3.34637286 | 6.57E-05   | 0.00150751 | 0.01688528 | 0.2           | 44.625     |
| HKS     | 7  | 182   | 4.13887852 | 6.58E-05   | 0.0011434  | 0.04640172 | 0.03846154    | 7.14       |
| ROB     | 8  | 247   | 3.48537139 | 6.75E-05   | 0.00114551 | 0.04750127 | 0.03238866    | 5.9748954  |
| R...P   | 22 | 1607  | 2.57703011 | 7.03E-05   | 0.00023789 | 0.00426797 | 0.01369011    | 2.47760252 |
| NKK     | 7  | 184   | 4.09389071 | 7.05E-05   | 0.00117005 | 0.04955097 | 0.03804348    | 7.05932203 |
| R..L    | 34 | 3036  | 2.09978889 | 7.74E-05   | 0.00032378 | 0.00549729 | 0.01119895    | 2.02165223 |
| W...K   | 24 | 1853  | 2.43803814 | 7.81E-05   | 0.00025522 | 0.00468403 | 0.01295197    | 2.34226353 |
| NKYK    | 3  | 18    | 3.13722456 | 8.08E-05   | 0.00150751 | 0.02063067 | 0.1875        | 41.1923077 |
| K.....N | 14 | 798   | 3.27208816 | 8.30E-05   | 0.00054278 | 0.00605972 | 0.01754386    | 3.1875     |
| R...Y   | 22 | 1627  | 2.5453518  | 8.33E-05   | 0.00026237 | 0.0049172  | 0.01352182    | 2.44672897 |
| KFSG    | 5  | 82    | 1.02023563 | 8.35E-05   | 0.00150751 | 0.02128916 | 0.08097561    | 11.5909091 |
| RWHFD   | 2  | 3     | 1.04485066 | 8.35E-05   | 8.35E-05   | 0.00011173 | 0.66666667    | 357        |
| FHHK    | 2  | 3     | 11.1545762 | 8.50E-05   | 0.00150751 | 0.02159252 | 0.66666667    | 357        |
| KKPH    | 2  | 3     | 11.1545762 | 8.50E-05   | 0.00150751 | 0.02159252 | 0.66666667    | 357        |
| LHHN    | 2  | 3     | 11.1545762 | 8.50E-05   | 0.00150751 | 0.02159252 | 0.66666667    | 357        |
| R...D   | 37 | 3539  | 1.96149182 | 8.54E-05   | 0.00039299 | 0.00623652 | 0.01045493    | 1.88592238 |
| SK      | 31 | 2652  | 2.14527806 | 8.68E-05   | 0.00024739 | 0.00526705 | 0.01168929    | 2.11121709 |
| HY      | 33 | 2865  | 2.11390142 | 8.70E-05   | 0.00024739 | 0.00526705 | 0.01151832    | 2.07997881 |
| K..P    | 25 | 1958  | 2.39401029 | 0.00011801 | 0.00042928 | 0.00778084 | 0.01276813    | 2.30858769 |
| K..Y    | 25 | 1962  | 2.38912953 | 0.00011199 | 0.00042928 | 0.00772709 | 0.0127421     | 2.30382034 |
| G.....R | 16 | 1034  | 2.88601973 | 0.0001136  | 0.00068971 | 0.00817917 | 0.01547389    | 2.80550098 |
| KRRH    | 3  | 18    | 2.78864405 | 0.00011649 | 0.00167972 | 0.02924016 | 0.16666667    | 35.7       |
| NKKH    | 3  | 18    | 2.78864405 | 0.00011649 | 0.00167972 | 0.02924016 | 0.16666667    | 35.7       |
| SPNL    | 3  | 18    | 2.78864405 | 0.00011649 | 0.00167972 | 0.02924016 | 0.16666667    | 35.7       |
| HREG    | 4  | 47    | 1.42398845 | 0.00011998 | 0.00167972 | 0.02975509 | 0.08510638    | 16.6046512 |
| L.K     | 32 | 2804  | 2.10249558 | 0.00012088 | 0.00045451 | 0.00846153 | 0.01141227    | 2.06060606 |
| K...P   | 21 | 1567  | 2.52268478 | 0.00013467 | 0.00040882 | 0.0078109  | 0.0134014     | 2.42464424 |
| K..L    | 33 | 3014  | 2.05290751 | 0.00013706 | 0.0005044  | 0.00932035 | 0.01094891    | 1.97601476 |
| S..K    | 28 | 2351  | 2.23307903 | 0.00014897 | 0.00052712 | 0.00998092 | 0.01190983    | 2.1515282  |
| Q.K     | 31 | 2711  | 2.10666412 | 0.00016398 | 0.00056606 | 0.01118793 | 0.01143492    | 2.06473891 |
| RHRR    | 3  | 20    | 2.50977965 | 0.00016146 | 0.00173325 | 0.03987954 | 0.15          | 31.5       |
| RWKG    | 3  | 20    | 2.50977965 | 0.00016146 | 0.00173325 | 0.03987954 | 0.15          | 31.5       |
| H.N     | 31 | 2715  | 2.10356038 | 0.00016259 | 0.00056606 | 0.01118793 | 0.01141805    | 2.0616617  |
| K.....H | 17 | 1180  | 2.68699443 | 0.00016309 | 0.0009242  | 0.0115797  | 0.01440678    | 2.60920034 |

FIG. 13G

| motif | n  | n.lib | enrich     | p          | fdr        | padj.holm  | Pr_seqs.motif | PLR        |
|-------|----|-------|------------|------------|------------|------------|---------------|------------|
| L...K | 24 | 1914  | 2.36038038 | 0.000166   | 0.00048656 | 0.00946217 | 0.01253919    | 2.26666667 |
| H...G | 49 | 5204  | 1.76545838 | 0.00016666 | 0.00056789 | 0.01099977 | 0.00941583    | 1.69670223 |
| HFRN  | 2  | 4     | 8.36593216 | 0.00016942 | 0.00173325 | 0.04150678 | 0.5           | 178.5      |
| KAAY  | 2  | 4     | 8.36593216 | 0.00016942 | 0.00173325 | 0.04150678 | 0.5           | 178.5      |
| KGGQ  | 2  | 4     | 8.36593216 | 0.00016942 | 0.00173325 | 0.04150678 | 0.5           | 178.5      |
| KHYP  | 2  | 4     | 8.36593216 | 0.00016942 | 0.00173325 | 0.04150678 | 0.5           | 178.5      |
| KPHP  | 2  | 4     | 8.36593216 | 0.00016942 | 0.00173325 | 0.04150678 | 0.5           | 178.5      |
| P.K   | 34 | 3122  | 2.00636129 | 0.00017185 | 0.00057692 | 0.01151388 | 0.01089045    | 1.96534974 |
| A...K | 28 | 2397  | 2.19022478 | 0.00017644 | 0.00057973 | 0.01146851 | 0.01166127    | 2.10975095 |
| HKRG  | 3  | 21    | 2.39026633 | 0.00018761 | 0.00178234 | 0.04502753 | 0.14285714    | 29.75      |
| RWHF  | 3  | 21    | 2.39026633 | 0.00018761 | 0.00178234 | 0.04502753 | 0.14285714    | 29.75      |
| S.R   | 32 | 2918  | 2.02035558 | 0.00019043 | 0.00061724 | 0.01256812 | 0.01096642    | 1.97920998 |
| RS    | 48 | 5032  | 1.75063667 | 0.00020761 | 0.00057251 | 0.01224919 | 0.00953895    | 1.71910112 |
| S...R | 28 | 2436  | 2.15515951 | 0.00021043 | 0.00066759 | 0.01346781 | 0.01349425    | 2.0755814  |
| R.Y   | 30 | 2632  | 2.09989941 | 0.00022308 | 0.00069899 | 0.01450029 | 0.01139818    | 2.05803228 |
| K...S | 33 | 3089  | 2.01098449 | 0.00022919 | 0.00064938 | 0.01283495 | 0.01068307    | 1.92751963 |
| K...Q | 27 | 2322  | 2.1802196  | 0.00024867 | 0.00076259 | 0.01566625 | 0.01162791    | 2.1        |
| A...R | 29 | 2575  | 2.11163794 | 0.0003112  | 0.00092355 | 0.01929431 | 0.01126214    | 2.03318932 |
| H...S | 29 | 2649  | 2.05390986 | 0.00031487 | 0.00137942 | 0.0226704  | 0.01094753    | 1.97576336 |
| RF    | 50 | 5413  | 1.69522518 | 0.00034688 | 0.00092841 | 0.02011885 | 0.00923702    | 1.6641805  |
| H...Q | 22 | 1773  | 2.33575149 | 0.00035564 | 0.00097354 | 0.01955993 | 0.01240835    | 2.24271845 |
| K...V | 18 | 1364  | 2.42569542 | 0.00035911 | 0.00190775 | 0.0251374  | 0.01300578    | 2.35212299 |
| H...S | 32 | 3062  | 1.96724061 | 0.00036651 | 0.00097354 | 0.01979141 | 0.01045089    | 1.88514851 |
| K...N | 17 | 1244  | 2.56385748 | 0.00038496 | 0.00160982 | 0.02733191 | 0.01366559    | 2.47310513 |
| R.N   | 29 | 2636  | 2.02682249 | 0.00039706 | 0.00120398 | 0.0254116  | 0.01100152    | 1.98561565 |
| S.K   | 31 | 2871  | 1.98926033 | 0.00042443 | 0.00124677 | 0.02673933 | 0.01079763    | 1.94841549 |
| R...W | 21 | 1655  | 2.38854807 | 0.00043382 | 0.00111741 | 0.02299237 | 0.01268882    | 2.29406365 |
| R.W   | 29 | 2681  | 1.99280271 | 0.00047751 | 0.00136017 | 0.02960535 | 0.01081686    | 1.95192308 |
| Y...K | 18 | 1399  | 2.41390475 | 0.00052926 | 0.00211352 | 0.03704793 | 0.01286633    | 2.32657495 |
| Y...R | 28 | 2577  | 2.03724051 | 0.00054628 | 0.00157055 | 0.03332306 | 0.01086535    | 1.96076893 |
| Y...R | 19 | 1525  | 2.33748642 | 0.00055135 | 0.00211352 | 0.03804342 | 0.01245902    | 2.25189203 |
| R...S | 24 | 2150  | 2.08196121 | 0.00058965 | 0.00294823 | 0.0406856  | 0.01116279    | 2.01505174 |
| N.R   | 32 | 3078  | 1.91533385 | 0.0006851  | 0.0018941  | 0.04179103 | 0.01039636    | 1.87524622 |
| A...K | 22 | 1896  | 2.1842233  | 0.00069761 | 0.00174403 | 0.03627576 | 0.01160338    | 2.09551761 |
| F.K   | 30 | 2875  | 1.92241226 | 0.00073275 | 0.00196795 | 0.04396477 | 0.01043478    | 1.86224956 |

## INTERNATIONAL SEARCH REPORT

International application No.

PCT/US2017/038392

## A. CLASSIFICATION OF SUBJECT MATTER

IPC(8) - C07K 14/00; C40B 30/04; G01N 33/53; G01N 33/574; G01N 33/68 (2017.01)

CPC - A61K 47/06; C12Q 1/68; G01N 2800/52 (2017.08)

According to International Patent Classification (IPC) or to both national classification and IPC

## B. FIELDS SEARCHED

Minimum documentation searched (classification system followed by classification symbols)

See Search History document

Documentation searched other than minimum documentation to the extent that such documents are included in the fields searched

USPC - 424/184.1; 424/193.1; 435/7.92; 435/7.23; 506/9 (keyword delimited)

Electronic data base consulted during the international search (name of data base and, where practicable, search terms used)

See Search History document

## C. DOCUMENTS CONSIDERED TO BE RELEVANT

| Category*    | Citation of document, with indication, where appropriate, of the relevant passages   | Relevant to claim No.                                |
|--------------|--|--|
| X<br>--<br>Y | US 2013/0079250 A1 (THE ARIZONA BOARD OF REGENTS, A BODY CORPORATE et al) 28 March 2013 (28.03.2013) entire document               | 1-7, 9, 20, 31<br>-----<br>10, 11, 19, 28-30, 57, 58 |
| X<br>--<br>Y | US 2014/0087963 A1 (JOHNSTON et al) 27 March 2014 (27.03.2014) entire document   | 32, 34, 56<br>-----<br>28-30                         |
| Y            | US 2014/0342939 A1 (YEDA RESEARCH & DEVELOPMENT CO. LTD. et al) 20 November 2014 (20.11.2014) entire document                      | 10, 11, 57, 58                                       |
| Y            | US 2013/0071860 A1 (HALE et al) 21 March 2013 (21.03.2013) entire document   | 19   |
| A            | WO 2015/095136 A1 (ARIZONA BOARD OF REGENTS ON BEHALF OF ARIZONA STATE UNIVERSITY et al) 25 June 2015 (25.06.2015) entire document | 1-16, 19, 20, 28-34,<br>56-58                        |

 Further documents are listed in the continuation of Box C. See patent family annex.

\* Special categories of cited documents:

"A" document defining the general state of the art which is not considered to be of particular relevance

"E" earlier application or patent but published on or after the international filing date

"L" document which may throw doubts on priority claim(s) or which is cited to establish the publication date of another citation or other special reason (as specified)

"O" document referring to an oral disclosure, use, exhibition or other means

"P" document published prior to the international filing date but later than the priority date claimed

"T" later document published after the international filing date or priority date and not in conflict with the application but cited to understand the principle or theory underlying the invention

"X" document of particular relevance; the claimed invention cannot be considered novel or cannot be considered to involve an inventive step when the document is taken alone

"Y" document of particular relevance; the claimed invention cannot be considered to involve an inventive step when the document is combined with one or more other such documents, such combination being obvious to a person skilled in the art

"&amp;" document member of the same patent family

Date of the actual completion of the international search

08 August 2017

Date of mailing of the international search report

08 SEP 2017

Name and mailing address of the ISA/US

Mail Stop PCT, Attn: ISA/US, Commissioner for Patents

P.O. Box 1450, Alexandria, VA 22313-1450

Facsimile No. 571-273-8300

Authorized officer

Blaine R. Copenheaver

PCT Helpdesk: 571-272-4300

PCT OSP: 571-272-7774

## INTERNATIONAL SEARCH REPORT

International application No.

PCT/US2017/038392

**Box No. II Observations where certain claims were found unsearchable (Continuation of item 2 of first sheet)**

This international search report has not been established in respect of certain claims under Article 17(2)(a) for the following reasons:

1.  Claims Nos.:  
because they relate to subject matter not required to be searched by this Authority, namely:
  
2.  Claims Nos.:  
because they relate to parts of the international application that do not comply with the prescribed requirements to such an extent that no meaningful international search can be carried out, specifically:
  
3.  Claims Nos.: 17, 18, 21-27, 35-55  
because they are dependent claims and are not drafted in accordance with the second and third sentences of Rule 6.4(a).

**Box No. III Observations where unity of invention is lacking (Continuation of item 3 of first sheet)**

This International Searching Authority found multiple inventions in this international application, as follows:

1.  As all required additional search fees were timely paid by the applicant, this international search report covers all searchable claims.
2.  As all searchable claims could be searched without effort justifying additional fees, this Authority did not invite payment of additional fees.
3.  As only some of the required additional search fees were timely paid by the applicant, this international search report covers only those claims for which fees were paid, specifically claims Nos.:
4.  No required additional search fees were timely paid by the applicant. Consequently, this international search report is restricted to the invention first mentioned in the claims; it is covered by claims Nos.:

**Remark on Protest**

- The additional search fees were accompanied by the applicant's protest and, where applicable, the payment of a protest fee.
- The additional search fees were accompanied by the applicant's protest but the applicable protest fee was not paid within the time limit specified in the invitation.
- No protest accompanied the payment of additional search fees.

|                |   |         |            |
|----------------|---|---------|------------|
| 专利名称(译)        | 诊断和治疗自身免疫疾病的方法  |         |            |
| 公开(公告)号        | <a href="#">EP3472181A1</a>   | 公开(公告)日 | 2019-04-24 |
| 申请号            | EP2017816083  | 申请日     | 2017-06-20 |
| [标]申请(专利权)人(译) | HEALTHTELL  |         |            |
| 申请(专利权)人(译)    | HEALTHTELL INC.   |         |            |
| 当前申请(专利权)人(译)  | HEALTHTELL INC.   |         |            |
| [标]发明人         | ROWE MICHAEL WILLIAM<br>TARASOW THEODORE MICHAEL<br>MELNICK JONATHAN SCOTT    |         |            |
| 发明人            | ROWE, MICHAEL WILLIAM<br>TARASOW, THEODORE MICHAEL<br>MELNICK, JONATHAN SCOTT |         |            |
| IPC分类号         | C07K14/00 C40B30/04 G01N33/53 G01N33/574 G01N33/68                            |         |            |
| CPC分类号         | C07K14/00 G01N33/564 G01N2800/60 G01N2800/104 G01N2800/56 G01N2800/24         |         |            |
| 优先权            | 62/352519 2016-06-20 US<br>62/421185 2016-11-11 US                            |         |            |
| 其他公开文献         | EP3472181A4   |         |            |
| 外部链接           | <a href="#">Espacenet</a>   |         |            |

#### 摘要(译)

本文提供了用于检测和诊断自身免疫疾病(包括系统性红斑狼疮)的方法,测定和装置。本文提供的方法,测定和装置分析肽阵列上的外周血抗体的结合模式,其与当前系统性红斑狼疮临床评估标准良好相关。