

(19)



(11)

EP 2 638 393 B1

(12)

EUROPEAN PATENT SPECIFICATION

(45) Date of publication and mention of the grant of the patent:

06.03.2019 Bulletin 2019/10

(51) Int Cl.:

G01N 33/53 (2006.01) **G01N 33/52** (2006.01)
G01N 21/17 (2006.01) **C12M 1/34** (2006.01)
G01N 15/12 (2006.01) **G01N 33/569** (2006.01)
G01N 33/543 (2006.01) **G01N 15/10** (2006.01)
G01N 15/14 (2006.01)

(21) Application number: **11839117.6**

(22) Date of filing: **09.11.2011**

(86) International application number:
PCT/US2011/060041

(87) International publication number:
WO 2012/064878 (18.05.2012 Gazette 2012/20)

(54) COUNTING PARTICLES USING AN ELECTRICAL DIFFERENTIAL COUNTER

ZÄHLUNG VON TEILCHEN MITHILFE EINES ELEKTRISCHEN DIFFERENTIALZÄHLERS

COMPTAGE DE PARTICULES AU MOYEN D'UN COMPTEUR DIFFÉRENTIEL ÉLECTRIQUE

(84) Designated Contracting States:

AL AT BE BG CH CY CZ DE DK EE ES FI FR GB GR HR HU IE IS IT LI LT LU LV MC MK MT NL NO PL PT RO RS SE SI SK SM TR

(30) Priority: **09.11.2010 US 411893 P**

(43) Date of publication of application:
18.09.2013 Bulletin 2013/38

(73) Proprietors:

- **The General Hospital Corporation**
Boston, MA 02114 (US)
- **Massachusetts Institute of Technology**
Cambridge, MA 02142-1324 (US)
- **The Board of Trustees of the University of Illinois**
Urbana, IL 61801 (US)
- **Daktari Diagnostics, Inc.**
Cambridge, Massachusetts 02139 (US)

(72) Inventors:

- **WATKINS, Nicholas**
Urbana
Illinois 61801 (US)
- **BASHIR, Rashid**
Champaign
Illinois 61821 (US)
- **RODRIGUEZ, William**
Cambridge
Massachusetts 02138 (US)

- **CHENG, Xuanhong**
Charlestown
Massachusetts 02129 (US)
- **TONER, Mehmet**
Wellesley
Massachusetts 02481 (US)
- **CHEN, Grace**
Cambridge
Massachusetts 02139 (US)
- **OPPENHEIMER, Aaron**
Cambridge
Massachusetts 02138 (US)

(74) Representative: **Conroy, John et al**
Fish & Richardson P.C.
Highlight Business Towers
Mies-van-der-Rohe-Straße 8
80807 München (DE)

(56) References cited:

WO-A1-2009/006456 **WO-A1-2010/086786**
WO-A2-03/006956 **WO-A2-2007/106598**
US-A- 5 260 192 **US-A1- 2003 235 917**
US-A1- 2009 298 067 **US-A1- 2010 075 340**

EP 2 638 393 B1

Note: Within nine months of the publication of the mention of the grant of the European patent in the European Patent Bulletin, any person may give notice to the European Patent Office of opposition to that patent, in accordance with the Implementing Regulations. Notice of opposition shall not be deemed to have been filed until the opposition fee has been paid. (Art. 99(1) European Patent Convention).

- DONG WOO LEE ET AL: "A Flow Rate Independent Cell Concentration Measurement Chip Using Electrical Cell Counters Across a Fixed Control Volume", JOURNAL OF MICROELECTROMECHANICAL SYSTEMS., vol. 17, no. 1, 1 February 2008 (2008-02-01), pages 139-146, XP055268493, US ISSN: 1057-7157, DOI: 10.1109/JMEMS.2007.906766
- GAWAD S ET AL: "MICROMACHINED IMPEDANCE SPECTROSCOPY FLOW CYTOMETER FOR CELL ANALYSIS AND PARTICLE SIZING", LAB ON A CHIP, ROYAL SOCIETY OF CHEMISTRY - CAMBRIDGE, GB, vol. 1, 1 January 2001 (2001-01-01), pages 76-82, XP008028057, ISSN: 1473-0197, DOI: 10.1039/B103933B
- WATKINS, N. N. ET AL.: 'A microfabricated electrical differential counter for the selective enumeration of CD4+ T lymphocytes' LAB CHIP. vol. 11, no. 8, April 2011, pages 1437 - 1447, XP055119466
- HOLMES, D. ET AL.: 'Single Cell Impedance Cytometry for Identification and Counting of CD4 T-Cells in Human Blood Using Impedance Labels' ANAL. CHEM. vol. 82, no. 4, February 2010, pages 1455 - 1461, XP055119469
- SUN, T. ET AL.: 'Single-cell microfluidic impedance cytometry: a review' MICROFLUID NANOFLUID vol. 8, March 2010, pages 423 - 443, XP019785777
- TAO SUN ET AL: "Single-cell microfluidic impedance cytometry: a review", MICROFLUIDICS AND NANOFLUIDICS, SPRINGER, BERLIN, DE, vol. 8, no. 4, 6 March 2010 (2010-03-06), pages 423-443, XP019785777, ISSN: 1613-4990
- Nicholas N. Watkins ET AL: "A microfabricated electrical differential counter for the selective enumeration of CD4+ T lymphocytes", Lab on a Chip, vol. 11, no. 8, 1 January 2011 (2011-01-01), page 1437, XP055119466, ISSN: 1473-0197, DOI: 10.1039/c0lc00556h

Description

[0001] This application claims the benefit of U.S. Provisional Application No. 61/411,893, filed on November 9, 2010.

5 **TECHNICAL FIELD**

[0002] This invention relates to counting particles such as cells, and more particularly to counting particles using electrical differential counters.

10 **BACKGROUND**

[0003] Counting of particles, such as cells, is of significant use in medicine and public health. One widely used cytometry system involves optical devices, such as flow cytometers, and tags cells of interest with optical labels (such as fluorescent markers) and interrogates them with light sources such as lasers.

15 [0004] The Coulter principle of impedance cytometry, based on resistive-pulse sensing, is well-established for counting cells non-optically. In its original format, Coulter counting allowed for differentiation of cells by size, to enable counting of individual subsets of a mixed population, such as a white blood cell differential. A second generation of impedance spectroscopy methods builds on the original Coulter principle and interrogates cells across a sweep of alternating current (AC) frequencies.

20 [0005] Microfluidic systems have shown unique promise for studying cell function, cell and tissue engineering, disease diagnosis, blood sample preparation, and drug discovery. Very recently, the use of microfluidics to isolate pure populations of leukocyte subsets from whole blood has attracted significant interest for point-of-care diagnostics. While the principle behind a cell isolation approach can be easily adapted to a wide spectrum of clinical applications, detecting these isolated cells remains a technical challenge to be addressed.

25 [0006] US 5,260,192 describes a method and apparatus for retrieving counting and/or analyzing at least one selected population of cells or formed bodies, such as a white blood cell population and at least one subset thereof of a whole blood sample or portion thereof.

[0007] WO 2007106598 describes methods, devices and kits for the isolation of a desired cell, including a chamber containing binding moiety specific for the desired cell.

30 [0008] Lee et al. ("A Flow Rate Independent Cell Concentration Measurement Chip Using Electrical Cell Counters Across a Fixed Control Volume"; JOURNAL OF MICROELECTROMECHANICAL SYSTEMS; VOL. 17, NO. 1, FEBRUARY 2008) describes a device counting cells at the inlet and outlet of a fixed control volume, to measure the cell concentration in a flowing fluid, independently of its flow rate.

35 **SUMMARY**

[0009] This disclosure describes devices, systems and methods for counting particles of interest in a mixed population of particles using a simple, low-cost electrical device according to the claims 1 or 2. Using a differential counting method with an electrical differential counter, these systems and methods can be used to count a subset of particles, e.g., white blood cells, from a starting sample, e.g., of whole blood, beyond the capability of current Coulter type systems and methods. For example, systems with two electrical impedance sensors can be used to obtain an absolute CD4+ T cell count from a blood sample.

40 [0010] In one aspect, the disclosure includes methods of counting particles of interest, such as cells, e.g., white blood cells, e.g., CD4+ T cells, in a sample, e.g., whole blood, that includes two or more different types of particles. These methods include obtaining a fluid sample that may contain particles of interest; counting all types of particles in a portion of the sample using a first electrical differential counter to generate a first total; removing any particles of interest from the portion of the fluid sample; counting any particles remaining in the portion of the fluid sample using a second electrical differential counter after the particles of interest are removed to generate a second total; and calculating a number of particles of interest originally in the fluid sample by subtracting the second total from the first total, wherein the difference is the number of particles of interest in the sample.

50 [0011] In these methods, the first and second electrical differential counters can be the same or a different electrical differential counter. In some implementations, these methods can further include reversing a flow direction of the fluid sample after removing the particles of interest from the portion of the fluid sample. In other implementations, the methods can further include maintaining a flow direction of the fluid sample while counting all types of particles in the portion of the sample; removing particles of interest; and counting any particles remaining in the portion of the fluid sample. In these methods, the particles, e.g., cells, of interest are removed from the portion of the fluid sample using one or more binding agents or moieties, such as antibodies, e.g., that specifically binds to a specific surface marker on the particle of interest, such as a white blood cell, such as a CD4+ T cell, or a particulate type of white blood cell, or a platelet, or

other specific cell in the sample, such as a tumor cell, e.g., a circulating tumor cell (CTC).

[0012] In other implementations, the methods can further include depleting selected particles from the portion of the sample before counting all types of particles in the portion of the sample. For example, if the sample is whole blood, the method can include depleting erythrocytes in the blood using a lysis technique. In other implementations, for example,

the fluid sample can include whole blood and the method can include depleting erythrocytes, monocytes, neutrophils, CD8+ lymphocytes, or other cellular components of blood by immuno-depletion.

[0013] In certain implementations, the particles of interest are CD4+ T cells, and removing the particles of interest includes capturing CD4+ T cells in a capture chamber functionalized with anti-CD4 antibodies. The methods can further include removing non-specifically adsorbed leukocytes by purging the capture chamber with phosphate buffered saline. The methods can also further include determining a cell flow direction based on a polarity of an impulse signal generated by the first electrical differential counter.

[0014] In another aspect, the disclosure includes devices that include a microfluidic chip defining a channel including an inlet and an outlet; a capture chamber arranged along the channel between the inlet and the outlet, wherein the chamber is configured to capture particles of interest from fluid flowing through the channel; a first electrical differential counter arranged to count all types of particles in a fluid flowing into the capture chamber; a second electrical differential counter arranged to count all types of particles remaining in the fluid flowing out of the capture chamber; and a computing mechanism in electronic communication with the first and second electrical differential counters, wherein the computing mechanism calculates a number of particles of interest based on signals from the first and second electrical differential counters.

[0015] In different implementations of these devices, the first and second electrical differential counters can be the same or different electrical differential counters. The devices can further include a pump system in fluid communication with the channel, wherein the pump system is operable in a first mode to cause fluid to flow in a first direction in the channel past the first electrical differential counter and operable in a second mode to cause fluid to flow in a second direction in the channel opposite the first direction and back to the first electrical differential counter.

[0016] In certain implementations, a portion of the channel can define a flow path that extends in a loop from the first electrical differential counter through the capture chamber and back to the first electrical differential counter.

[0017] In various implementations, the capture chamber includes surfaces functionalized with binding agents, such as anti-CD4 antibodies.

[0018] In another aspect, the disclosure includes kits that include a device as described herein; a solution that includes a binding agent or moiety, such as an antibody, e.g., that specifically binds to a specific surface marker on a white blood cell, such as aCD4+ T cell, with an affinity for the particles of interest; and a solution comprising a lysing agent effective to lyse selected particles without lysing the particles of interest. In the devices in these kits, the first and second electrical differential counters can be the same or different electrical differential counters, and the devices can further include a pump system in fluid communication with the channel, wherein the pump system is operable in a first mode to cause fluid to flow in a first direction in the channel past the first electrical differential counter and operable in a second mode to cause fluid to flow in a second direction in the channel opposite the first direction back to the first electrical differential counter.

[0019] In some implementations, a portion of the channel defines a flow path that extends in a loop from the first electrical differential counter through the capture chamber and back to the first electrical differential counter.

[0020] In another aspect, the disclosure describes microfluidic chips that include a plurality of capture chambers, wherein the capture chambers are configured to capture particles of interest from fluid flowing through the chambers; an electrical differential counter operable to count particles in a mixed population of particles in fluid flowing into the capture chambers and to count particles remaining in fluid flowing out of the capture chamber; and a computing mechanism in electronic communication with the electrical differential counter, the computing mechanism operable to calculate a number of particles of interest based on signals from the electrical differential counter.

[0021] These microfluidic devices can further include a fluidic channel coupled to the plurality of chambers, wherein the fluidic channel includes a first channel region and a second channel region, wherein the first channel region is configured to receive a lysing solution and a sample fluid, and mix the sample fluid with the lysing solution, and wherein the second channel region is configured to receive a quenching solution and a lysed solution from the first channel region, and mix the quenching solution with the lysed solution.

[0022] In any of the forgoing aspects and implementations, the binding agents or moieties can be selected from antibodies, antibody fragments, oligo- or polypeptides, nucleic acids, cellular receptors, ligands, aptamers, MHC-peptide monomers or oligomers, biotin, avidin, oligonucleotides, coordination complexes, synthetic polymers, and carbohydrates.

[0023] Also in any of the forgoing aspects, the sample can be a blood sample, the binding moiety can bind to CD66, CD14, CD4, CDS, EpCAM, E-Selectin, or P-Selectin, and the desired cell can be selected from neutrophils, monocytes, lymphocytes, circulating tumor cells (CTCs), HIV infected CD8 lymphocytes, circulating endothelial cells, and platelets. In some implementations, the desired cells of interest are CD4+ lymphocytes. In this implementation, the sample may be obtained from a patient at risk of developing AIDS.

[0024] By a "patient" is meant a living multicellular organism. The term "patient" is meant to include humans, mice, dogs, cats, cows, sheep, horses, non-human primates, and fish.

[0025] By "binding moieties" or "binding agents" is meant a molecule that specifically binds to an analyte (e.g., a cell). Binding moieties include, for example, antibodies, aptamers, receptors, ligands, antigens, biotin/avidin, metal ions, chelating agents, nucleic acids, MHC-peptide monomers, tetramers, pentamers, or other oligomers.

[0026] By "cell surface marker" is meant a molecule bound to a cell that is exposed to the extracellular environment. The cell surface marker can be a protein, lipid, carbohydrate, or some combination of the three. The term "cell surface marker" includes naturally occurring molecules, molecules that are aberrantly present as the result of some disease condition, or a molecule that is attached to the surface of the cell.

[0027] By "lysis" is meant disruption of the cellular membrane. For the purposes of this invention, the term "lysis" is meant to include complete disruption of the cellular membrane ("complete lysis"), partial disruption of the cellular membrane ("partial lysis"), and permeabilization of the cellular membrane.

[0028] By "binding moiety" is meant a chemical species to which a cell binds. A binding moiety may be a compound coupled to a surface or the material making up the surface. Exemplary binding moieties include antibodies, antibody fragments (e.g., Fe fragments), oligo- or polypeptides, nucleic acids, cellular receptors, ligands, aptamers, MHC-peptide monomers or oligomers, biotin, avidin, oligonucleotides, coordination complexes, synthetic polymers, and carbohydrates.

[0029] The term "chamber" is meant to include any designated portion of a micro fluidic channel, e.g., where the cross-sectional area is greater, less than, or the same as channels entering and exiting the chamber.

[0030] The methods and devices described herein provide several benefits and advantages. In particular, the approaches described herein can be used to provide novel devices for cell analysis that are smaller, less expensive, and simpler to use than presently existing large, expensive, and complex flow cytometers, Coulter counters and impedance spectroscopes. The devices described herein can be used to discriminate a wider number of cell types and subtypes than currently known Coulter counters and impedance spectroscopes. The smaller, less expensive, microfabricated devices described herein can require much smaller volumes of blood or plasma and expensive reagents. They can be less expensive to operate and maintain. These devices represent mobile platforms that can be used at the point of care, independent of health care infrastructure. As closed, one-time use, disposable devices for the handling of blood and other biohazardous fluids, these devices reduce system risks and costs. Thus, the new methods and devices can be used to diagnose various diseases such as HIV/AIDS and cancers such as leukemia, and can be used to monitor a patient's progress with medication, e.g., to determine the overall efficacy of a particular treatment regimen used for a given patient.

[0031] Compared to optical cytometry methods, the simplicity of the electrical interrogation methods as described herein, and extended to multi-frequency impedance methods can be used to create a more streamlined, cost-effective, and mechanically robust solution for portable cellular analysis. The devices described herein are simpler and less expensive, in part, because they do not require a stable light path and the associated lensing, filtering, and focusing mechanisms that can add cost and complexity to optical detection methods. Moreover, the devices described herein can have higher throughput, than optical detection devices, which tend to have low throughput because of the small detection area available at a single time.

[0032] The microfabricated cell counters described herein are unlike Coulter counters, in that they can be used to count complex subsets of cells in a simple, handheld system without the need for external cell surface labels and other reagents, which add complexity and cost to the assay. Moreover, unlike cell counting strategies like flow cytometry and impedance measurement, the microfabricated cell counters described herein can be used with cells attached to surfaces even to count small numbers of cells on large surface areas in a relatively large volume.

[0033] Detection and enumeration of cells are essential for medical diagnostics, especially for AIDS and cancer diagnosis, and pathogen detection. While most existing methods to detect cells are optical (i.e., microscopy), electrical detection is significantly simpler, cheaper, and more amenable to point-of-care devices. To date, electrical detection and enumeration of intact cells based on impedance spectroscopy (i.e., detection of changes in electrical impedance caused by the presence of cells) have proven to be extremely practical and inexpensive, but limited to large cell populations or homogenous cell types (e.g., Coulter counting of red blood cells or total lymphocytes).

[0034] The combination of selective particle depletion in a microfluidic device using controlled shear flow, with double counting provides the new particle counting systems based on a subtraction assay concept. Both the microfluidic particle capture methods and the resistive pulse particle count methods are extremely robust and simple, and can thus be used to produce a robust, inexpensive diagnostic kit, e.g., for CD4 cell counting. For example, referring to FIG. 1, a droplet of whole blood provided by a finger stick can be applied to the inlet of a chip incorporating the cell counting techniques described herein. Red blood cell lysis and absolute CD4+ T cell counting, as well as on-chip sample preparation for a subsequent viral load test, can be performed on the chip.

[0035] Unless otherwise defined, all technical and scientific terms used herein have the same meaning as commonly understood by one of ordinary skill in the art to which this invention belongs. Although methods and materials similar or equivalent to those described herein can be used in the practice or testing of the present invention, suitable methods

and materials are described below. In addition, the materials, methods, and examples of the description are illustrative only and not intended to be limiting.

[0036] Other features and advantages of the invention will be apparent from the following detailed description, and from the claims.

5

DESCRIPTION OF DRAWINGS

[0037]

10 FIG. 1 is a schematic of a cell counting method and device, including test cartridges that include the microfluidic chips described herein.
 FIGS. 2A-2E are schematics of use a microfluidic circuit in a cell counting device.
 FIG. 3 is a schematic of a chip incorporating a cell counting device.
 FIG. 4 is a schematic illustrating fabrication of a cell counting device.
 15 FIG. 5 is a schematic of a differential cell counter experimental setup.
 FIG. 6 is a circuit schematic of a self-referencing electrical sensor using three electrodes connected in a Wheatstone bridge configuration.
 FIG. 7 is graph comparing estimated inlet concentrations with measured chip concentrations.
 FIG. 8 is a graph presenting entrance and exit counts for a passivated capture chamber experiment.
 20 FIG. 9 is a graph illustrating the relationship between white blood cell concentration and the discrepancy between the entrance and exit counts.
 FIGs. 10A to 10C are a series of graphs illustrating the effect of including a shearing module in a cell counter.
 FIG. 11 is a schematic of a differential cell counter experimental setup based on a reverse flow concept using of a single pair of electrodes for a differential CD4+ T cell count.
 25 FIG. 12 is a graph comparing the error in counts found using the reverse-flow differential counter protocol with the total number of cells counted.
 FIG. 13 is a graph presenting entrance and exit counts for a passivated capture chamber experiment using the reverse-flow differential counter protocol.
 FIG. 14 is a series of merged images of an entire differential counter chip with magnification of regions near the entrance (1), mid-section (2), and exit (3).
 30 FIG. 15 is an area histogram of circular objects on a chip as observed using optical counting.
 FIG. 16 is a graph presenting forward and reverse flow counting of CD4+ T cells.
 FIG. 17 is a schematic of a device using a single electrode set for counting cells flowing into and out of the capture chamber. The device includes a counting device in which a portion of the channel defines a flow path that extends
 35 in a loop from the first electrical differential counter through the capture chamber and back to the first electrical differential counter as shown in FIG. 17.
 FIGs. 18 is a schematic of a particle counting device and a graph of impedance signal as a function of time showing the signals caused by particles flowing in opposite directions.
 FIG. 19A is a graph comparing % error found using the reverse-flow differential counter protocol with the total number
 40 of cells counted.
 FIG. 19B is a graph that illustrates the cumulative forward and reverse counts for cells using the reverse-flow differential counter protocol.
 FIG. 20A is a graph comparing electrical and optical counts. FIG. 20A shows results from 14 CD4+ T cell counting experiments using white blood cells purified from human whole blood samples and the close correlation ($y = 0.994x$, $R^2 = 0.997$) between the electrical differential method and the optical control.
 45 FIG. 20B is a graph depicting a Bland-Altman analysis of the data in FIG. 20A.
 FIG. 21 is a graph comparing % error with CD4+T cell counts. FIG. 21 illustrates how the percent error (absolute difference in optical and electrical counts, normalized by the CD4+ T cell count) relates to the total number of CD4+ T cells counted.
 50 FIG. 22 is a graph that illustrates the generation of discrete impedance signal trigger threshold levels.
 FIGs. 23A to 23C show the results of the dynamic threshold analysis procedure.
 FIG. 23A shows differential counts vs. trigger level and shows stability between 8x and 12x trigger levels. Slope
 FIG. 23B and curvature FIG. 23C analysis identifies 12x as the optimal trigger level because it is part of the most
 55 stable regime in the curve.
 FIG. 24 is a graph that illustrates the cumulative forward and reverse counts for cells using the 12x trigger threshold level.
 FIG. 25 is a schematic of a differential cell counter.
 FIG. 26 is a plot of percent error of differential cell counts for whole blood samples.

[0038] Like reference symbols in the various drawings indicate like elements.

DETAILED DESCRIPTION

5 [0039] The new systems and methods are based on a simple and low-cost electrical counting method and can be used to count particles of interest in a mixed population of particles in a sample, such as a fluid sample, or a particulate sample dispersed in a fluid. Using differential counting methods with an electrical differential counter, these systems and methods can be used to count a subset of white blood cells from a starting sample of whole blood. For example, systems with two electrical impedance sensors can be used to obtain an absolute CD4+ T cell count from a blood sample.

10 [0040] The new micro-scale devices operate using a novel subtraction impedance interrogation technique. In the described methods, a complex mixture of particles in a starting sample is passed through an electrode configuration for resistive-pulse or impedance sensing, and a total count of particles in the collective starting sample can be obtained. Next, particles of interest can be selectively retained in a microchannel through the use of a specific, immobilized capture reagent under controlled shear flow. Finally, the remaining population of particles in suspension can be passed through a second electrode configuration for resistive-pulse sensing, and a second count of the total population, depleted of the particles of interest, can be obtained. The difference between the two counts represents the count of the captured particles, and thus, the particle count of interest.

15 [0041] This approach can be used, for example, in a CD4+ T cell micro-cytometer, which is a micro-scale device for CD4+ T cell counting and which can be used as part of a kit for use in a point-of-care system for monitoring CD4+ T cell counts. In this implementation, whole blood is passed through an electrode sensing region, and the total particle count is obtained for the collective starting sample. The CD4+ T cells in the sample are selectively depleted through the use of anti-CD4 antibodies, immobilized in a microfluidic chamber or channel under controlled shear flow. The remaining population of particles in the CD4+ T cell depleted whole blood is passed then through a second electrode sensing region, and a second count of the total population depleted of the particles of interest is obtained. The difference between the two counts represents the count of the captured CD4+ T cells. This kit, device, and method can be used for counting CD4+ T cells from a finger stick of blood at the point of care.

20 [0042] As shown in FIG. 1, the device can be fully realized as (1) a one-time use, disposable cartridge 10 that contains all the microfluidics and sensing elements described herein, and (2) a hand-held cartridge reader 20, which provides the electrical sensing, stimuli, and fluidic controls (e.g., pumping mechanisms). The top of FIG. 1 also shows a flow diagram of the path of a droplet of whole blood, e.g., provided by a finger stick, from application to the inlet of a device (e.g., a sample cartridge and reading unit) incorporating the cell counting techniques described herein. The blood passes through a red blood cell lysis station and an absolute CD4+ T cell counting station, as well as an on-chip sample preparation station and a subsequent viral load test station.

25 [0043] As shown in FIG. 1, the drop of blood 30 (~10 to 20 μ L volume) would be dropped onto the cartridge's receiving port after (or before) the cartridge 10 is inserted into the reading unit 20. The reading unit 20 would control the infusion of the blood and other fluids through the cartridge in addition to applying the electrical signal to the cartridge's sensing region and reading the change in the electrical signal caused by the passage of cells through the cartridge 10. The reading unit 20 would then analyze the electrical signals and calculate the concentration of the target cells, which would be displayed to the operator. As discussed in more detail below, different cartridges can be designed to sense for different diseases simply by changing the binding agent, e.g., antibody type, in the chip's capture region.

A Cell Counting Device in Operation

30 [0044] Use of an exemplary cell counting device 100 is illustrated in FIGS. 2A- 2E. Cell counting device 100 includes two impedance sensors 110 and 111. The cell counting device 100 defines a microfluidic circuit or channel 112, which extends from a sample inlet 114 through a selective particle depletion chamber or capture chamber 116 to a sample outlet 118. The sample inlet 114 receives an unprocessed or a processed sample to be analyzed. The following discussion describes the use of cell counting device 100 to count CD4+ T cells in a sample of whole blood. Cell counting devices as described herein can also be used to analyze other samples including, for example, plasma, urine, sputum, or other biological or other fluids, e.g., industrial fluids, that contain two or more different types of particles.

35 [0045] Cell counting device 100 includes an optional reagent inlet 120, where one or more sample processing reagents can be introduced and mixed with the sample. In some instances, reagents introduced through this manner can be red blood cell lysing reagents, sample stabilization reagents, particle surface labels, or other reagents of interest.

40 [0046] Channel 112 can include an optional sample processing area 122, where the starting sample can be further processed or purified to make particle counting faster, more accurate, or more efficient. In cell counting device 100, the sample processing area 122 is a red blood cell lysis area and a monocyte depletion area. For example, the sample processing area 122 can include surfaces coated with a monocyte capture reagent such as an anti-CD 14 antibody. In general, the capture chambers are functionalized or coated with binding agents or binding moieties as described herein.

These binding moieties are selected to specifically bind to the particles, e.g., to surface markers on cells, and not to other particles that may be present in the sample. The sample processing area 122 can be a red blood cell lysis area, or a monocyte depletion area, or both.

5 [0047] Impedance sensors 110 and 111 are located in channel 112 on each side of capture chamber 116. Impedance sensors 110 and 111 are electrode configurations for the counting of particles in fluid flowing through the channel 112. The impedance sensors 110 and 111 can be two-electrode or three-electrode resistive pulse sensors of the Coulter type, for the counting of blood cells. The current implementation uses a coplanar electrode configuration, meaning all electrodes are on the same surface, and an AC signal is being passed between the electrodes. In other implementations, the impedance sensors 110 and 111 may be configured where each electrode and its mate are parallel to each other (still perpendicular to fluid flow direction), but one electrode is on the floor of the chamber while the other is on the ceiling of the chamber. The electrodes could also be placed parallel to each other, but at the sides of the channel (still perpendicular to the flow of cells). Another implementation is a fluidic electrode, where an electrical signal is passed through a small channel with a conductive solution that flows perpendicularly to the cell flow direction. The electrical leads in this case could be microfabricated or metal wires placed in each end of the fluidic electrode channel.

10 [0048] In addition, an AC (alternating current) or DC (direct current) signal can be used to sense cell passage. For a DC signal, Ag-AgCl (silver/silver chloride) electrodes could be used, as they provide excellent redox reaction efficiency even under high electrical current. In other implementations, the impedance sensors 110 and 111 can be, for example, capacitive sensors, resistive sensors, or other sensor modalities that measure the intrinsic optical or magnetic properties of the cells in a label free manner, or sensor modalities that measure labels associated with the cells.

15 [0049] Capture chamber 116 is a selective particle depletion or capture chamber, where particles of interest are selectively captured onto a surface or surfaces of the chamber using binding moieties such as analyte capture or binding agents and controlled shear, substantially as described in US 2009/0298067 A1, "Devices and Methods for Detecting Cells and Other Analytes" (which is incorporated herein in its entirety). In some implementations, capture chamber 116 is functionalized with anti-CD4 antibodies and serves as a selective CD4+ T cell depletion chamber. Of course, capture chamber 116 can be functionalized with any other binding agents, e.g., antibodies, aptamers, and binding pairs, which selectively bind to the specific particle or particles of interest. Such binding agents are known, or can be easily determined, for a given particle, e.g., cell, of interest.

20 [0050] In some implementations, the cell counting device 100 includes an optional fluidic entry channel 124 for sending reagents into the capture chamber 116 and an optional fluidic exit channel 126 for removing reagents sent into the capture chamber 116. The optional fluidic entry channel 124 and the optional fluidic exit channel 126 can be used, for example, to selectively functionalize the chamber with binding moieties.

25 [0051] The sample outlet 118 collects flow-through sample and sends it downstream, for example to a self-contained waste area. In some instances, the sample outlet 118 collects flow-through sample and sends it downstream to a downstream assay, or a further processing area on the microfluidic chip.

30 [0052] In some implementations, the cell counting device 100 also includes an optional selective sample processing area 128, where the sample is processed prior to mixing with reagents introduced through the reagent entry inlet 120. For example, the selective sample processing area 128 can be a selective filtration area where unwanted particles are filtered mechanically or chemically.

35 [0053] Before use, the cell counting device 100 is prepared by using the fluidic entry channel 124 and the fluidic exit channel 126 to selectively functionalize the capture chamber 116 with a binding agent, e.g., an antibody specific to the CD4 antigen that resides on the surface of the helper T cells and monocytes (though containing an order of magnitude less than the helper T cells).

40 [0054] In use, the sample, e.g., whole blood is introduced into the cell counting device 100 through the sample inlet 114 and a chemical to lyse the red blood cells is introduced into the cell counting device 100 through the reagent inlet 120 (see FIG. 2B). Flowing through the sample processing area 122, red blood cells are lysed as the whole blood mixes with the red blood cell lysing agent and monocytes are captured on surfaces coated with a monocyte capture reagent such as an anti-CD14 antibody (see FIG. 2C). All white blood cells are counted as they pass the entrance impedance sensor 110. The enumerated cells enter a large capture chamber 116 that is functionalized with an antibody specific to the CD4 antigen. The capture chamber 116 retains CD4 T cells and monocytes while the remainder of the white blood cells exit the capture chamber 116 and are enumerated by the exit counter 111 (see FIG. 2D). PBS can then be introduced through reagent inlet 120 to wash away non-specifically bound cells in the capture chamber 116. A first electronic processor 130 is linked to the first electrode configuration 110, and records individual particle signals as resistive pulses or other electrical measurements. A second electronic processor 132 is linked to the second electrode configuration 111, and records individual particle signals as resistive pulses or other electrical measurements. With a known sample volume, the concentration of helper T cells can be obtained by finding the difference between the entrance and exit counts (see FIG. 2E).

50 [0055] This method can be adapted to count other cell types simply by choosing different antibodies for the particular cell surface antigen. The red blood cell lysis region can increase throughput, as erythrocytes' have a concentration of

5 x 10⁹/mL in whole blood, which would prove quite difficult to count in a timely manner necessary for a global health diagnostics application. In addition, the sensitivity and accuracy in finding helper T cell counts would be severely diminished by the presence of the red blood cells. For example, if 10 μ L of blood sample is analyzed, approximately 5 x 10⁷ red blood cells, 1 x 10⁵ white blood cells, and 1 x 10⁴ helper T cells (in a healthy adult) would be counted. Only 0.02 percent of the counted cells would be helper T cells, which could easily be masked by the non-ideal situation of red blood cells being counted at the entrance, but not at the exit (one reason being that some red blood cells non-specifically adsorb to the capture chamber). Removal of the red blood cells would increase the percentage of helper T cells to 10% out of the total cells counted, greatly increasing the chip's accuracy and precision in providing cell counts.

Design and Fabrication

[0056] FIG. 3 shows a differential counter device 100 without the red blood cell lysis region 122. The fluidics layer (a) contains inlet and outlet ports for cell sample flow and two ports used to functionalize the 50 μ m-high (6.6 μ L) capture region with antibodies. The two impedance sensing regions are made with 15 μ m-wide and 15 μ m-high channels that funnel the cells over three 10 μ m-wide platinum electrodes, spaced 10 μ m apart (b). The height of the capture region was chosen to increase the volume of sample and ensure the proper shear stresses at the wall-fluid interface. According to Cheng et al. ("Cell detection counting through cell lysate impedance spectroscopy in microfluidic devices," Lab on a Chip, vol. 7, pp. 746-755, 2007), a shear stress of >3 dyn \cdot cm⁻² resulted in less effective CD4 T cell capture. The equation

$$\tau_{\omega} = \frac{6\mu Q}{h^2 \omega_1}$$

can be used to estimate the shear stress at the walls of a rectangular microfluidic channel of a constant width, ω_1 , where μ is the dynamic viscosity of the fluid, Q is the volumetric flow rate, and h is the height of the channel (Usami et al., "Design and construction of a linear shear stress flow chamber," Annals of Biomedical Engineering, vol. 21, no. 1, pp. 77-83, January 1993). This shows the sensitive, inverse-squared relationship between the channel height and the shear stress at the chamber's ceiling and floor. A 15 μ m capture channel would give a shear stress of 10 dyn \cdot cm⁻², well above the aforementioned maximum shear stress limit. This shear stress would create a force of -155 pN on a 10 μ m cell's membrane, which is the same order of magnitude as the dissociation force of antibody-antigen interactions (see, e.g., Hinterdorfer et al., "Detection and localization of individual antibody-antigen recognition events by atomic force microscopy," Proceedings of the National Academy of Sciences of the United States of America, vol. 93, no. 8, pp. 3477-3481, 1996; Dammer et al., "Specific antigen/antibody interactions measured by force microscopy," Biophysical Journal, vol. 70, pp. 2437-2441, May 1996; and Harada et al., "Specific and quantized antigen-antibody interaction measured by atomic force microscopy," Langmuir, vol. 16, no. 2, pp. 708-715, November 2000).

[0057] A 50 μ m capture channel height greatly reduces the average shear stress to 0.45 dyn \cdot cm⁻², resulting in a force of -14 pN on the cell and greatly increasing the cell's surface antigen interactions with the immobilized Ab to facilitate cell capture. The 34 mm capture channel length ensures sufficient interaction time (about 80 seconds at sample flow rate of 5 μ L \cdot min⁻¹).

[0058] Three-dimensional hydrodynamic focusing was desired, but would have effectively increased the entrance flow rate (0.125 μ L/minute for a 5 μ L/minute cell sample flow rate) and corresponding shear stress of 11.1 dyn \cdot cm⁻², which is well beyond the maximum to facilitate CD4+ T cell capture. In addition, the cell passage time through the 15 μ m x 15 μ m counter pore at this flow rate would result in transition times faster than 90 ns, which is well below the minimum transition time of ~2 μ s that can be resolved using the lock-in amplifier described in the experimental section.

[0059] The fluidics and electrical sensing layers are then aligned and bonded to form the completed differential counter (c).

[0060] Fabrication of the differential counter is illustrated for one counter region in FIG. 4. The electrical sensing layer can be fabricated using the standard metal lift-off process. A 4" glass wafer (Pyrex® 7740) is first spin-coated with LOR2A liftoff resist, soft-baked at 183 °C for 5 minutes and is coated with S-1805. After another soft-bake at 110 °C for 90 seconds, the wafer is aligned to the electrodes mask on a Quintel Q7000 IR backside mask aligner and exposed for a total dose of 2.8 mJ \cdot cm⁻². The wafer is then placed on a 110 °C hotplate for a 60 seconds post-exposure bake before being immersed into Microposit MF CD-26 developer for 80 seconds and rinsed with DI water for 2 minutes (FIG. 4(a)). The wafer is then de-scummed in an O₂ plasma system for 20 seconds before being placed in a CHA Evaporator for the deposition of 25 nm of Ti seed layer, followed by a 75 nm Pt conduction layer (FIG. 4(b)). The undesired metal is lifted off by placing the wafer in a 70° C bath of Microchem Remover PG for 15 minutes, creating the necessary conduction paths for the referenced counters (FIG. 4(c)).

[0061] The multi-height fluidics layer is created by fabricating a negative image of the desired channels using Microchem SU-8 25 photoresist. SU-8 25 is spun on a 4" Si wafer to a height of 15 μ m, and is pre-baked in two steps for 2 minutes

at 65 °C and then 95 °C for 5 minutes. The wafer is aligned and exposed to a mask defining all of the fluidic channels, including the capture region, counters, sample inlet and outlet, and Ab functionalization ports (FIG. 4(d)). A second layer of SU-8 is spun on to obtain a total thickness of 50 pm for the entire wafer, and is pre-baked at 65 °C for 5 minutes and then 95 °C for 15 minutes. The wafer is then exposed to a second mask only defining the capture chamber, allowing it to have a height of 50 pm, compared to the other fluidic regions of 15 pm in height. The wafer is developed in Microchem SU-8 developer for 2 minutes at room temperature, rinsed with isopropyl alcohol, and hard-baked at 125 65 °C for 15 minutes (FIG. 4(e)). Polydimethylsiloxane (PDMS), 1:10::curing agent:base, is poured over the negative mold and allowed to cure overnight at 65 °C (FIG. 4(f)). The polymerized mold is peeled off, and ports are punched for all inlets and outlets using a blunt syringe needle.

[0062] The sealed fluidic chip is completed by aligning and bonding the electrode sensing layer to the fluidics layer after oxygen plasma activation in a barrel etcher (FIG. 4(g)). Teflon microbore tubing is used to make fluidic connections between the chip and syringe pumps. The lysis region can be completed using the techniques described in Sethu et al. have shown that it is feasible to create a microfluidic red blood cell lysis device using diffusive mixing (see, e.g., Sethu et al., "Continuous flow microfluidic device for rapid erythrocyte lysis," *Analytical Chemistry*, vol. 76, pp. 6247-6253, 2004 and Sethu et al., "Microfluidic isolation of leukocytes from whole blood for phenotype and gene expression analysis," *Analytical Chemistry*, vol. 78, pp. 5453-5461, 2006).

Differential Counter Setup

[0063] FIG. 5 illustrates an example of a setup that can be used to differentially count CD4+ T cells. Initially, a pump, such as a Harvard Apparatus PicoPlus syringe pump, is used to flow a known volume of sample, e.g., white blood cells (from whole blood samples with lysed red blood cells), into the chip inlet and through the entrance counter, capture chamber, e.g., a CD4 Ab-functionalized capture chamber, and exit counter at a steady flow rate, e.g. 2, 3, 4, 5, 6, 7, 8, 9, or 10 $\mu\text{L}/\text{minute}$. After sample flow, PBS is pumped into the chip at a higher flow rate to remove any non-specifically bound cells from the capture chamber. An amplifier, e.g., a Zurich Instruments HF2LI dual lock-in amplifier, is used to inject an AC signal, e.g., a 5 V (rms) 1.1 MHz AC signal, into the exit and entrance sensors. Relative impedance is measured using a two-electrode arrangement that is self-referencing in a Wheatstone bridge configuration balanced with resistors and capacitors, e.g., 10 k Ω resistors (R) and a 68 pF capacitor.

[0064] FIG. 6 provides a closer look at the balancing bridge configuration. When no particle is passing through the sensing region, the current on both branches is approximately the same, because both electrode impedances are similar and R is equal for both branches. Therefore, $V_1 \approx V_2$ and V_{out} is ~ 0 V. When a cell passes through the sensor region (going from left to right), it will temporarily increase the impedance between the first and middle electrodes, reducing the current in the left branch and decreasing the voltage drop across V1, creating a negative pulse for V. The cell then passes between the middle and third electrode and conversely causes a positive pulse at V. As a result, each cell passage creates a down-up (or up-down, depending on the definition of V_{out}) pulse pair. This bridge balancing provides several benefits, including providing a baseline signal that varies little with changes to fluid conductivity or flow rate and providing a more sensitive detection method creating a larger impedance pulse signal-to-noise ratio. In addition, one can accurately determine whether cells are flowing past the sensor in a forward or reverse direction to ascertain total forward and reverse counts, respectively. Pulse polarity will reverse when direction reverses. Each cell passage creates either an up-down (or down-up) pulse signature in the forward flow direction, while in the reverse flow direction, all cells create down-up (or up-down) pulse signatures, respectively, enabling a straightforward method to differentiate between cells entering and exiting the chip.

[0065] The bridge potential difference signals for the entrance ($V_{\text{out},1}$) and exit ($V_{\text{out},2}$) are input into the amplifier, and the impedance magnitude and phase angle (R and θ , respectively) are output to a computer for real-time observation and recording of data, e.g., at a 115.2 kHz sampling rate using, for example, Lab-VIEW® software. The data is imported into and analyzed with Clampfit software. Impedance pulses can be counted using various threshold levels, and entrance and exit counts are compared. Another computer connected to a digital camera on a microscope, such as a Nikon Eclipse E600FN microscope (Nikon Instruments, Inc., Melville, NY), can be used to observe cell passage through the channels as well as cellular interactions with the capture region.

Reverse-Flow Differential Counter

[0066] Although the shearing unit helps improve the operation of the differential counter device, another major problem arises in that it has proven difficult to objectively choose the correct trigger level for each counter to provide accurate counts. Ideally, both sensors should have the same electrical characteristics and require the use of the same trigger threshold levels. However, it seems that different threshold levels should be used, but several systematic methods to objectively choose the levels have failed (e.g., using triggers based on each electrode's baseline noise and calculating one counter's trigger level based on the weighted average of the other counter's pulse amplitude distribution). This may

arise from the possibility that the electrical characteristics of each sensing region are different enough to cause an error in cell enumeration. Although microfabrication may provide entrance and exit counters with almost identical electrode geometries, other factors may cause each sensor to have different electrochemical properties. The metal lift-off procedure may leave nanoscale imperfections that vary from sensor to sensor, creating different field edge effects that may affect a counter's response to cell passage. Non-homogenous metal layer thicknesses from uneven evaporation (sometimes observed by a gradient in color of the metal layer through the entire die) would change the conductivity of the metal leads and the sensing region itself, especially between two counters on a single die that are separated by 34 μm . The connecting micromanipulator probing tips and external circuitry may also have different electrical characteristics between each branch. Some symptoms from these possible sources are (1) a counter's signal-to-noise ratio does not necessarily scale with its baseline's standard deviation, (2) differences between V_{0,t_1} and V_{0,t_2} for two sensors on the same chip, which should be the same, and (3) sometimes slowly changing V_{0,t_1} or V_{a,t_2} values over time may point to electrochemical reactions occurring at the electrode-electrolyte interface.

[0067] To solve this threshold ambiguity problem, a single sensor can be used. FIG. 11 illustrates the concept of flowing white blood cells through the entrance of the chip and reversing the flow to push the cells back out the entrance. Cells are injected into the entrance port and flow into the functionalized capture chamber to capture helper T cells. When pulses are observed at the exit counter, the fluidic valves are switched to allow PBS to flow through the chip via the exit port, forcing all unattached cells to be counted again through the entrance counter. Washing continues until all unattached cells are washed from the chip. Because this method only uses the entrance counter to enumerate white blood cells, the problem of finding an objective threshold level is significantly reduced. The threshold can simply be chosen as the minimum level in which baseline noise is not counted as cellular events. The exit counter is used only qualitatively to see when cells have filled the capture region volume and to begin the reverse washing process.

[0068] The self-referencing sensor allows for easy discrimination between cells entering and exiting the entrance counter port. For example, depending on the external electrical configuration, a cell entering the entrance counter may create an up-down impedance pulse pair in time, while the same configuration will create a down-up signature for cells exiting under reverse flow past the entrance counter port (see, e.g., FIG. 18).

[0069] The improved accuracy of using a single electrode set for counting cells flowing into and out of the capture chamber described above with respect to the reverse flow implementation can also be provided by a counting device in which a portion of the channel defines a flow path that extends in a loop from the first electrical differential counter through the capture chamber and back to the first electrical differential counter as shown in FIG. 17. As discussed above with respect to FIG. 18, the pulse shape can be used to determine when cells are entering the chip and when cells are exiting the chip.

Obtaining Pure Leukocyte Samples from Whole Blood

[0070] Red blood cells can be lysed before flowing the cells through the differential counter chip. A lysis solution, e.g., of 0.12 % (v/v) formic acid and 0.05% (w/v) saponin in DI, is used for erythrocyte lysis. A large excess of the lysis solution, e.g., 12 mL of lysis solution, is added to 1 mL of whole blood (drawn the same day and kept on a rotator at room temperature and incubated for 6 seconds with agitation). Lysis is immediately stopped by the addition of quenching solution (such as 5.3 mL of 0.6% (w/v) sodium carbonate and 3% (w/v) sodium chloride in DI) (see, e.g., D. Holmes, D. Pettigrew, C. Reccius, J. Gwyer, C. van Berkel, J. Holloway, D. Davies, and H. Morgan, "Leukocyte analysis and differentiation using high speed microfluidic single cell impedance cytometry," Lab on a Chip, vol. 9, pp. 2881-2889, 2009). The solution is centrifuged for 5 min. at 200 x gravity at room temperature, supernatant is aspirated, and pellet resuspended in 5 mL PBS + 1% (w/v) bovine serum albumin (BSA). The quenching solution is centrifuged for 5 minute at 200 x gravity at room temperature, supernatant is aspirated, and pellet resuspended in 5 mL PBS + 1% (w/v) bovine serum albumin (BSA). The suspension is centrifuged again and resuspended in 1 mL PBS + 1% BSA, giving the physiological concentration of white blood cells.

[0071] In a point of care implementation of the cell counting device 100, the red blood cell lysis could be performed on chip as described with reference to FIGS. 2A-2E.

Dynamic Threshold Analysis for Objective Enumeration of Cells

[0072] The impedance signal threshold level is the single most important variable in the electrical enumeration of cells in electrical differential counting; finding an objective method to choose the threshold is equally important. By definition, this threshold level determines whether impedance pulses are the entities of interest (cells, beads, etc.), or simply debris, electrical noise, or other entities that should be ignored during analysis. Generally, the threshold level can be based on integral multiples of the standard deviation of the baseline electrical signal when no cells are passing through the sensor region. In this way, most false positives from electrical noise are excluded when the threshold level is set at or above four to six times the standard deviation of the baseline signal level. However, choosing the threshold level based on

electrical signal's standard deviation alone remains to be a subjective analysis method.

[0073] Even a small change in the threshold level can result in a large change in cell counts, especially at lower threshold levels. Listed below are some additional issues that can render this threshold scaling method impractical, because of large counting errors when performing differential counts; whether using the forward flow method with two counting electrodes (FIG. 5), the reverse-flow method with one counting electrode (FIG. 9), or other implementations (e.g., FIG. 17).

(1) A cell may not produce the same impedance pulse amplitude when passing through the second sensor in a forward flow, two-counter design or when passing back through the entrance counter in a reverse-flow, one-counter design. This introduces counting error because a cell may be counted entering the capture chamber, but not counted when leaving the capture chamber.

(2) The electrical noise level may vary enough during or between analyses to possibly trigger false positive counts if only a static threshold level was chosen.

(3) Debris or small entities (e.g., fragments of dead cells, platelets, etc.) may create impedance pulses with amplitudes that exceed the threshold, creating false positives.

(4) The optimal threshold levels may change from chip to chip because of the possible physical and/or electrical differences among fabricated chips. A static threshold level for all chips could result in inconsistent measurements that would seriously undermine the advantage of the microfabricated technology.

[0074] The present solution for the task of objectively choosing a cell counting trigger threshold is to dynamically choose the proper threshold level by analyzing the impedance signal(s) with a range of discrete threshold levels. During or immediately after blood analysis, differential counts (i.e., entrance count - exit count, or forward count - reverse count) are plotted against their corresponding threshold trigger levels, and the optimal threshold level is chosen based on curve stability (i.e., "flatness"). This method has shown to have a low inherent counting error of ~ 9 cells $\cdot \mu\text{L}^{-1}$ (FIG. 19A, Table 2).

[0075] FIGS. 22, 23, and 24 illustrate this concept using data from an actual differential counting experiment.

[0076] First, discrete threshold levels are obtained. One method to create these levels is to obtain the standard deviation of the baseline impedance signal (before cell flow commences) to create a multiplicative standard (i.e., "1x" is the standard deviation). Trigger levels can either be calculated linearly (e.g., multiplication of the 1x standard), or through more complex, nonlinear methods. FIG. 22 shows a range of trigger threshold levels generated using the linear method, and how the 6x trigger (six times the standard deviation of the noise) encounters the baseline noise signal, which would result in false positive cell counts. The range (e.g., 6x to 20x) and multiplicative values (e.g., 6x, 6.5x, 7x, etc.) can be modified to ensure optimal analysis with proper dynamic range and resolution, respectively.

[0077] Second, the impedance signal(s) are analyzed with the generated range of trigger levels, and differential counts are plotted against their respective trigger levels. FIG. 23A shows the variation of differential CD4+ T cell counts for a range of threshold trigger levels (6x to 20x). In the ideal situation where each entity's pulse amplitude is identical for entering and exiting the capture chamber, the plot should be a horizontal line, showing that the differential counts are constant for all trigger levels. However, the smaller threshold levels encounter the signal's baseline noise level, creating many false positives that statistically conceal the true positives. The sudden increase in differential counts from 6x to 8x illustrates this non-ideality, as the 6x threshold level is too low in that it is falsely counting noise peaks as "cells." The differential count levels off at 8x and remains flat until 12x, where the counts gradually decreased. This plateau contains the optimal threshold trigger level and corresponding differential count because it best resembles the ideal horizontal line. Another deviation from the ideal plot is shown by the gradual decrease in the differential counts at larger trigger levels. This can possibly be explained that the average pulse height for the exiting entities is lower than the average pulse height for the entering entities (e.g., complication #1, listed above).

[0078] Third, the variation of counts between contiguous trigger levels is plotted to further investigate the most stable region of the count vs. trigger level curve. This is analogous to finding the slope of the plot in FIG. 23A, and is shown in FIG. 23B. Specifically, the slope values (s_x) are calculated from Equation 1:

$$s_x = \frac{(c_x - c_{x-1})}{(t_x - t_{x-1})} \quad (1)$$

where c_x is the differential count and t_x is the trigger level at index x . In this case, x is limited to indices 2 to n , where n is defined as the total number of trigger levels used for analysis. Index 1 is excluded because, by definition, no slope can be calculated for index 1. Noteworthy: s_x gives the slope immediately *before* the trigger value at index x .

[0079] Fourth, the variation in slope values between trigger levels is plotted to make the final stability assessment of the count vs. trigger level curve. This is analogous to finding the curvature of the plot in FIG. 23a (or equally the slope of the plot in FIG. 23b) and is shown in FIG. 23(c). Specifically, the variation in slope values (v_x) between two contiguous

triggers is calculated from Equation 2:

$$v_x = \frac{(s_x - s_{x-1})}{(t_x - t_{x-1})} \quad (2)$$

In this case, x is limited to indices 3 to n . This is because no slope values exist to calculate the slope variation for indices 1 and 2. Noteworthy: s_x gives the curvature immediately *before* the trigger value at index x .

[0080] Fifth, average curvature values are obtained for adjacent trigger levels to find the threshold level that is within the most stable regime of the counting analysis curve. The smallest average curvature corresponds to the optimal trigger level. Specifically, the average curvature (a_x) for two adjacent curvature values for a trigger level at index x is calculated using Equation 3:

$$a_x = \frac{|v_x| + |v_{x+1}|}{2} \quad (3)$$

In this case, x is limited to indices 3 to $n - 1$, as curvature values are not available for indices 1, 2, and n .

[0081] The aforementioned methodology to identify the proper trigger threshold level can be succinctly described in the following steps:

1. Generate a range of discrete threshold values (FIG. 22).
2. Obtain differential counts for a range of threshold values, c_x (FIG. 23A).
3. Find the count variation vs. trigger level, s_x (FIG. 23B and Equation 1).
4. Obtain curvature vs. trigger level, v_x (FIG. 23C and Equation 2).
5. Calculate averages of contiguous v_x values (Equation 3).
6. Search for the minimum v_x value and note its index, which belongs to the optimal threshold trigger level. The count for this index is chosen to be the actual differential count for diagnostic results.

[0082] Table 1 provides the data displayed in FIG. 22A-C and is used to illustrate the dynamic threshold optimization process described above. The average curvature value at index 4 (a_4) corresponds to a 12x trigger level, resulting in a differential count of 1,804 CD4+ cells (selection highlighted in FIG. 23C). FIG. 24 shows the cumulative forward and reverse counts found using a 12x trigger level for the duration of the experiment.

Table 1

Index (x)	Trigger Level (x 1x standard)	Differential Count (c_x)	Slope (s_x)	Curvature (v_x)	Avg. Curv. (a_x)
1	6	-7	<i>n/a</i>	<i>n/a</i>	<i>n/a</i>
2	8	1810	908.5	<i>n/a</i>	<i>n/a</i>
3	10	1759	-25.5	-467.0	245.5
4	12	1804	22.5	24.0	31.5
5	14	1693	-55.5	-39.0	35.4
6	16	1455	-119.0	-31.8	28.9
7	18	1113	-171.0	-26.0	19.4
8 (n)	20	720	-196.5	-12.8	<i>n/a</i>

[0083] This dynamic threshold analysis method has been shown to provide counts which correlate closely ($y = 0.994x$, $R^2 = 0.997$) with an optical enumeration method (FIG. 20A). This shows it to be a feasible method for the automatic enumeration of particles and cells using an electrical differential counting technique. FIG. 15 is an area histogram of circular objects on a chip as observed using the optical counting method. FIG. 20B shows Bland-Altman comparison analysis between the electrical differential and optical counting methods. A bias of only about 9 cells confirms the accuracy of the electrical differential counting method for the entire range of enumerated CD4+ T cells.

[0084] The aforementioned methods do not limit the scope of the dynamic threshold analysis method, but serve as an example to prove its feasibility and efficacy. The following are additional notes regarding other implementations of

the dynamic threshold analysis method. First, integer multiples were used to generate discrete threshold values, but fractions of whole numbers can be used as well (e.g., 4.25x). Second, plotting the different data (c_x , s_x , v_x , a_x) is not necessary, but was used for illustrative purposes. The operating device's microcontroller or microprocessor would only need the raw differential counting data (c_x) to calculate the average curvature values (a_x). Third, analysis is not limited to Equations 1 - 3, as other implementations may be used to find the optimal thresholds more efficiently and/or effectively. Fourth, nonlinear methods can be used to generate threshold levels in addition to the linear method used in the above example. Fifth, threshold analysis is not limited to pulse amplitude (or height), but can be used on other variables, such as pulse width, pulse area, or other implementations. Sixth, threshold analysis is not limited to pulses with positive polarity, but can also be used for negative-going pulses. Seventh, the number of and spacing between threshold levels can be adjusted to provide a more accurate rendering of the threshold level vs. differential count plot to locate the optimal threshold level with higher precision.

Cell Counting Devices with Lysis and Quenching Regions

[0085] In some implementations, an on-chip lysis region, e.g., a red blood cell lysis region, can be included in the counting device, e.g., a CD4+ T cell counting device. The addition of the lysis region can eliminate requirements for additional laboratory equipment and personnel that are needed to lyse the red blood cells off-chip, enhancing the portability of the device. For example, FIG. 25 is a schematic that illustrates a CD4+ T cell counting device 2500 that incorporates a cell lysing region 2502 (e.g., for lysing red blood cells). During operation of the device 2500, whole blood flows into the chip and is surrounded by a lysis solution, which mixes in the serpentine mixing channels 2504 and rapidly ruptures the red blood cells within about 6 to about 10 seconds. Different conditions can be used to lyse other types of particles, e.g., cells. To ensure lysis during a desired time period, the volume of the lysis region channels and the flow rate of the lysis and sample, e.g., blood, solutions can be controlled. For example, the lysis region's channel width can range from about 50 μm to about 1 mm and height can be from about 10 μm to about 400 μm with lysis and blood solutions combined flow rates ranging from about 1 $\mu\text{L}/\text{minute}$ to about 100 $\mu\text{L}/\text{minute}$.

[0086] Lysis is rapidly stopped to preserve the remaining cells, such as white blood cells, by the addition of a quenching solution and quench duration is extended via serpentine mixing channels 2506 to ensure quenching of the lysis process, which should have a duration of greater than about 10 seconds. The quenching channel dimensions and the combined flow rates of the lysing, blood, and quenching solutions can be controlled to ensure quenching duration is above this minimum. For example, the quenching channel dimensions can be formed to be similar to the lysis region channels and the combined flow rates of the lysis, blood, and quenching solutions can range from about 1 $\mu\text{L}/\text{minute}$ to about 1000 $\mu\text{L}/\text{minute}$. The quenched solution then flows through a filter 2508 comprised of pores to prevent possible clogging of the counting pore having the same dimensions as the filter pores. The filter and counting pores can range in size from a height and width each of about 0.5 μm to about 50 μm .

[0087] The sensing electrodes of the counter 2510 can be made of a conduction layer of either platinum or gold or other high conductivity metal with an adhesion layer (optional) of chromium or titanium. The sensing electrodes can have widths and gaps ranging from less than about 1 μm to about 1 mm. The Coulter principle can be employed to electrically count cells individually by observing the temporal impedance changes (i.e., electrical pulses). White blood cells then pass through an identical filter before being distributed among eight identical capture chambers 2516, which can be from 10 μm to 100 μm high and 0.5 mm to 10 mm wide. The number of capture chambers 2516 can vary from 1 to over 32. Capture chamber height can be tailored to control the shear stresses at the fluid/chamber wall interface for optimal capture of CD4+ T cells or other cells/particles of interest.

[0088] The devices can be made with a glass substrate (with micro-patterned platinum or gold electrodes) bonded to PDMS (polydimethylsiloxane) fluidics via oxygen plasma treatment. Another method uses plastics for the substrate and fluidics (e.g., injection molding) with the sensing electrodes defined by laser ablation or similar processes.

Cell Counting Devices That Distinguish Between Different Types of Cells

[0089] In some implementations, the cell counting devices can differentiate between different types of white blood cells, red blood cells, and platelets based solely on using multiple interrogation frequencies. This technique enables counts of red blood cells, platelets, and white blood cell subtypes (monocytes, neutrophils, lymphocytes, etc.) in addition to the specific enumeration of CD4+ T cells using the antibody-coated capture chamber, as already described. For example, referring to FIG. 2, multiple signals of different frequencies can be applied simultaneously to one or more of the impedance sensors 110, providing a discrete impedance spectrum for any particular cell type.

[0090] Cells can be differentiated based on their different impedance spectra. For example, Holmes et al. used a 503 kHz frequency to obtain the volume of each cell, but also used a higher frequency (1.7 MHz) to simultaneously inspect a cell's membrane capacitance. They were able to differentiate among some of the different white blood cell subsets (monocytes, neutrophils, and T-lymphocytes) via observing the opacity of a cell (high frequency impedance divided by

the low frequency impedance) with the assistance of a red blood cell lysis solution (see Holmes et al., "Leukocyte analysis and differentiation using high speed microfluidic single cell impedance cytometry," Lab on a Chip, 2009, 9, 2881-2889; see also Ledis et al., "Lysing reagent system for isolation, identification and/or analysis of leukocytes from whole blood samples," U.S. Patent No. 5,155,044, October 1992). In addition, Cheung et al. used a 6 MHz frequency to differentiate between red blood cells and white blood cells (see, Cheung et al. "Microfluidic Impedance-Based Flow Cytometry," Cytometry: Part A, 2010, 77A, 648-666).

[0091] Accordingly, a low frequency (e.g., from about 1 kHz up to about 1 MHz) can be applied to the impedance sensors 110 to obtain a cell's volume and additional higher frequencies (e.g., from about 1 MHz to over 100 MHz) can be applied to the impedance sensors 110 to provide a discrete impedance spectrum for differentiating among several cell types. The more discrete frequencies used, the higher the resolution to differentiate between different cell types that can be indistinguishable at a smaller number of interrogation frequencies used. In particular, platelets can be discriminated among other cell types based simply on their size, as they are approximately 1 to 2 μm in size—much smaller than other cell types. As a result a low frequency measurement alone can differentiate platelets from other cell types. Red blood cells can be distinguished from white blood cells using a low frequency (500 kHz) and a high frequency (6 MHz), as red blood cells have a similar volume to the smaller white blood cells. In some implementations, different white blood cell types may require one or more frequencies in addition to the low frequency (500 kHz) for differentiation among the white blood cell subtypes.

EXAMPLES

[0092] The following examples are illustrative and not limiting.

Testing Maximum Pulse Density Limits

[0093] It is desired that the differential counter can enumerate the physiological concentration of white blood cells flowing at the desired range of 5-10 $\mu\text{L}/\text{min}$ to provide a rapid helper T cell count. As the concentration of cells increases with a constant flow rate, the amount of average volume (and time) decreases between events (i.e., pulses caused by cell passage through the sensing region). Eventually, the concentration becomes high enough where two cells will be in the same sensing region, creating coincident events that reduce the accuracy of the counter. In addition, for a finite sampling frequency, even if the cells are not coincident in the sensing region, a high enough velocity will eventually cause overlap of the pulses from two subsequent cell passages.

[0094] Diluted whole blood was used to test the pulse density limits of the differential counter, because it contains an abundance of flexible particles, as opposed to polystyrene and latex beads, which have been prone to clog the counting channel. A constant flow rate of 5 $\mu\text{L}/\text{min}$ was used to inject varying dilutions (1:1000 to 1:100) of whole blood into the chip. Pulses were only analyzed for the entrance counter. Pulse density was calculated by enumeration of pulses in known duration windows at random times throughout the raw data.

[0095] FIG. 7 illustrates the results as a comparison between the cell concentration found using the microfluidic chip (calculated by the number of pulses for a known volume flown) compared to the calculated concentration of each dilution (assuming a whole blood concentration of 5×10^9 cells/mL). At a 5 $\mu\text{L}/\text{minute}$ flow rate, the microfluidic chip could handle the 1:200 dilution of whole blood ($\sim 2.5 \times 10^7$ cells/mL), but failed to count every pulse for the 1:100 dilution ($\sim 5 \times 10^7$ cells/mL). The maximum pulse density the chip could handle was 2,236 cells/s, equivalent to a concentration of 2.68×10^7 cells/mL at a flow rate of 5 $\mu\text{L}/\text{minute}$. This is well above the upper limit of leukocyte concentration in healthy adults, ensuring no coincident events, even at a flow rate of 10 $\mu\text{L}/\text{minute}$.

Testing Capture Chamber Sensitivity and Accuracy

[0096] The next experiments were done to verify that the entrance count is the same as the exit count for a passivated capture chamber. A 10 μL sample of healthy adult blood (with lysed erythrocytes) can have over 100,000 leukocytes, in which 10,000, or 10%, are helper T cells. A patient with AIDS can have helper T cell counts less than 200 cells/ μL , which results in only 2,000 cells per 10 μL , or 2% of total leukocytes. Any errors in counting can negatively affect the sensitivity and accuracy of this method.

[0097] Before cells were flowed into the microfluidic chip, the capture chamber was passivated by flowing in PBS + 1% BSA and incubating for 30 minutes at room temperature to prevent the non-specific adsorption of cells to the glass and PDMS surfaces. BSA is a well-known protein for surface passivation, and readily binds to the hydrophilic glass substrate at pH 7.4 (see e.g., Sweryda-Krawiec et al., "A new interpretation of serum albumin surface passivation," Langmuir, vol. 20, pp. 2054-2056, September 2004). In this particular experiment, three dilutions of white blood cells were flown into the chip at 5 $\mu\text{L}/\text{minute}$, followed by a 10 $\mu\text{L}/\text{min}$ PBS + 1% BSA wash to ensure all cells exit through the exit counter. Impedance data for each counter is recorded during the entire experiment.

[0098] FIG. 8 illustrates a typical result for the negative control experiment. Ideally, the entrance and exit sums should be equivalent at the end of the experiment, but have a difference of over -3,500. It was interesting to note that the exit count was higher than the entrance count, which is true for the 1:1 dilution of white blood cells, but not as dominant in the lower dilutions. FIG. 9 shows the relationship between the white blood cell concentration and the difference between the exit and entrance counts for various trigger levels. A trigger level is the voltage threshold that determines whether an impedance pulse is a cell, and is set manually in Clampfit. It is a common convention to base the trigger level on the standard deviation of the baseline signal's noise (with no cells present).

[0099] In this experiment, a trigger level of ten times the standard deviation (SD) of the noise was the minimum threshold that could be used to ensure baseline noise pulses were not counted as cellular events. The threshold level for the entrance and exit counters was identical. A noticeable trend is the less diluted samples intersect the X-axis (Entrance - Exit = 0) at higher threshold values (67 x SD for 1: 1; 40 x SD for 1:2; 20 x SD for 1:5) in the direction of increasing trigger level value (left to right). This, combined with the fact that the exit count is higher than the entrance count, can explain the large discrepancy in the entrance and exit counts. Cell aggregates form more frequently as the concentration of the purified leukocytes increases, because there is more interaction between cell surfaces. These aggregates pass through the entrance counter port and its relatively high shear stresses (1,320 dyne/cm) separate the aggregates back into individual cells, which are then counted by the exit counter. An aggregate is counted as a single entity by the entrance counter, but can become three or more entities by the time it reaches the exit counter. The entrance and exit counts only become equal when the threshold level is large enough to not count smaller entities such as single cells, and only counts larger objects that remain physically intact after passing through the entrance counter.

[0100] The aggregation of leukocytes prevents a true evaluation of the differential counter and can be remedied by larger dilutions. However, diluting has several drawbacks, most importantly, analyzing only a fraction of the cells needed to provide a more robust helper T cell test and requiring a much larger chip volume. Therefore, it is desirable to have physiological concentration of white blood cells enter the chip, and can possibly still be allowed using a microfabricated 10 μm x 13 μm PDMS/glass pore, or "shearer," to separate cell aggregates before the chip entrance. FIG. 10A shows the results after repeating the passivated experiment for 1:1 diluted leukocytes. The shearer proves to decrease the number of aggregates before entering the differential counter chip (X-intercept at 9 x SD vs. 12.5 x SD for cell samples injected directly into the chip without the shearer).

[0101] FIG. 10B shows the difference in cell size (pulse amplitude) and cell passage duration when using the shearer. The population undergoing shear before making it to the entrance counter is a tighter distribution at lower pulse duration with similar pulse height amplitude as the un-sheared population because the larger aggregates block the impedance sensing region longer. The amplitude does not change much because even the single cells are large enough to block most of the electrical current passing between the sensing electrodes.

[0102] FIG. 10C illustrates the size and passage duration similarities of cells that have been sheared prior to and counted at the entrance sensor and cells that did not undergo pre-chip shearing, but pass through the entrance counter pore and are counted at the exit counter. This shows that the entrance counter indeed is shearing aggregates into smaller entities, performing the same job as the pre-chip shearer. It is therefore necessary to have the shearing unit placed before the chip to ensure most aggregates are separated into single cells.

Testing a Reverse-Flow Differential Counter

[0103] The passivated capture chamber experiments noted above were repeated using the reverse-flow protocol, and the results of fourteen different experiments are shown in FIG. 12 and FIG. 19A. The *forward* count is equivalent to the number of leukocytes that entered the capture chamber during forward flow; the absolute error count is the difference from the ideal differential count of zero; the percent error is the absolute error count normalized by the forward count. FIG. 12 shows how the absolute error count remained roughly constant for the entire forward counting range. This resulted in a decreased percent error for larger forward counts (FIG. 19A), which is desirable. FIG. 13 is a graph presenting entrance and exit counts for a passivated capture chamber experiment using the reverse-flow differential counter protocol.

[0104] FIG. 19B illustrates the accumulated forward and reverse counts during the experiment highlighted in FIG. 19A. This demonstrates how the reverse count eventually leveled off and became close to the forward count. As Table 2 below shows, forward counts greater than 2,000 resulted in a much smaller error. This ensures that larger leukocyte numbers-found in clinical situations-will result in the lowest error. The decreasing % error for increasing total *forward* cell counts can be explained by the fact that the counting errors do not scale with the total number of cells flown, and remain relatively constant.

Table 2

Data Range	Error (%) (Fig. 12 inset)		Abs. Counting Error (cells) (Fig. 12)		Est. Sensitivity (cells· μL^{-1})	
	\bar{x}	SD	\bar{x}	SD	\bar{x}	SD
All WBC	2.91	3.93	44.2	31.3	8.84	6.26
WBC < 2000	7.25	5.37	38.8	25	7.76	5
WBC > 2000	1.18	1.02	46.4	34.5	9.28	6.9

[0105] Table 2 summarizes the data from FIG. 12 and FIG. 19A for different ranges of total white blood cells counted. The estimated sensitivity can be obtained by assuming approximately 5 μL of sample was flown into the chip (approximate because current metering methods are in need of improvement). As a result, base sensitivity is ~ 9 cells/ μL for the more realistic range of greater than 2,000 white blood cells counted, which is similar to the best sensitivity in electrical CD4+ T cell counts in the literature (Cheng et al., "Cell detection counting through cell lysate impedance spectroscopy in microfluidic devices," Lab on a Chip, vol. 7, pp. 746-755, 2007). The main source of counting errors was caused by non-specific adsorption of cells onto the chamber surface, despite passivation with BSA. A more successful passivation using more incubation time and/or PBS with a pH closer to BSA's isoelectric point of 5 would substantially decrease this error and illustrate that the differential counting method would provide the most sensitive enumeration technique (Freeman et al., "Real time, high resolution studies of protein adsorption and structure at the solid-liquid interface using dual polarization interferometry," Journal of Physics: Condensed Matter, vol. 16, pp. S2493-S2496, 2004). Another possible source of error may be dead/dying cells rupturing under the high shear rates found in the counter channel after forward counting.

Enumeration of CD4+ T Cells Using the Reverse-Flow Technique

[0106] The reverse-flow technique was used to electrically enumerate the number of CD4+ T cells captured on a microfluidic chip. The capture region was first coated with an anti-CD4 antibody (Ab)(1: 10 in PBS) by adsorption for 30 minutes, followed by several iterations of flowing in more Ab and waiting 10 minutes between each iteration. Unbound Ab was removed by rinsing the chamber with PBS + 1% BSA, which also passivates any surface which does not have Ab adsorbed to it. White blood cells were flown into the chip at 5 μL /minute until cells were electrically detected at the exit counter. PBS + 1% BSA was then infused through the exit counter port initially at 5 μL /minute to increase the interaction time between the helper T cells and the CD4 Ab. The washing flow rate was increased to 10 μL /minute after most cells had exited the chip to wash away any non-specifically bound cells.

[0107] After electrical counting, an optical control was obtained by imaging the captured cells for subsequent enumeration using image processing software. Phase contrast images of the entire capture region were taken using an Olympus IX81 inverted microscope at 40x total magnification. The 42 images were aligned and merged using Adobe Photoshop image processing software, and cells were counted using ImageJ software. FIG. 14 shows the merged images and resultant image of the entire capture and counter regions. It was found that the highest density of captured cells was found before the midpoint of the capture chamber's length (inset 2). A smaller density of cells were found near the inlet (inset 1), which is expected since the cells have not had enough time to interact with the Ab on the chamber surface. The lowest density is found near the exit of the chamber, where very few cells are attached (inset 3). Most likely the washing process began before the higher concentration of cells made it to the exit, but could also be because the majority of the helper T cells had ample time to bind to the immobilized CD4 Ab.

[0108] It was also noted that the cell path does not span the entire width of the capture channel. This results because the relatively narrow counter channel acts as a highly-focused nozzle which causes most of the cells to travel within ± 850 μm of the centerline of the channel's length. This can be resolved by placing the entrance and exit counters diagonally opposite of each other (in opposite corners of the capture chamber), which would force the cells to travel the diagonal length of the capture chamber. Another solution may simply be found by curving or fanning the counter outlets so that the cells will not be as focused once entering the capture chamber.

[0109] FIG. 15 shows the automated counting of circular objects of various internal areas. The dotted lines denote the range of areas assumed for the helper T cells and gives a helper T cell count of 926. This range encompasses cell diameters from 10 to 12.5 μm , which is somewhat larger than the diameter of lymphocytes reported in the literature, but these cells are not in optimal physiological conditions and may have initiated apoptosis. Also, the phase contrast imaging creates a halo around the cell diameter, which could cause an apparently larger cell, especially when taken at a low magnification, where the size of the pixels are relatively larger and may not create an accurate representation of the cell's perimeter.

[0110] FIG. 16 shows the results of the reverse-flow differential counting of captured helper T cells. The obtained count of 931 cells closely matches the count found by image processing, and shows that the differential counter method is viable method of enumerating helper T cells in a microfluidic chip.

[0111] FIG. 20 shows results from 14 CD4+ T cell counting experiments using white blood cells purified from human whole blood samples and the close correlation ($y = 0.994x$, $R^2 = 0.997$) between the electrical differential method and the optical control. FIG. 21 illustrates how the percent error (absolute difference in optical and electrical counts, normalized by the CD4+ T cell count) relates to the total number of CD4+ T cells counted. For less than 1,000 cells captured on the chip, the average error is 4.5% ($n = 3$). Assuming a 5 μL sample volume, this would be for CD4+ T cell concentrations less than 200 cells/ μL , the concentration limit which defines AIDS. This shows to be highly accurate, as a patient with an actual CD4+ T cell concentration of 100 cells/ μL would have a counting error of only +/- 4.5 cells/ μL . For counts above 1,000 cells captured in the entire chip, the average error is 2.1% ($n = 11$). The 25+/-10% ($n = 14$) ratio of captured cells to total cells counted agrees with the literature concerning the 25-33% of leukocytes being CD4+ T cells (Daniels et al., "Functional histology: A text and colour Atlas," Churchill Livingstone, 1979).

15 Cell Counting Using Device With Lysing and Quenching Regions

[0112] Experiments were set up to evaluate the reverse electrical differential counting method with the additional red blood cell lysing and quenching regions to ensure its feasibility in diagnostics testing using the device 2500 described above. The chip's capture regions and exit holding coil were passivated from cellular interactions using a 1% BSA (bovine serum albumin) solution in PBS (pH 4.5) for three hours. The holding coil was used to ensure cells exiting the chip during forward flow direction would not be lost to waste before flow reversal. Various sample sizes of whole blood (0.5 to 10 μL) were injected into the chip at a flow rate of 1.5 $\mu\text{L}/\text{min}$. The lysing solution (0.12% (v/v) formic acid and 0.05% (w/v) saponin) and quenching solution (2x PBS and 0.6% sodium carbonate) were infused at 17.5 $\mu\text{L}/\text{min}$ and 8.5 $\mu\text{L}/\text{min}$, respectively, using an HPLC pump. Flow was reversed once the desired blood volume was injected and the experiment duration ended when cells were completely washed from the chip and holding coil.

[0113] FIG. 26 illustrates the percent error of twenty-three differential cell counts for whole blood samples. The percent error is calculated as the absolute difference between the forward and reverse counts, normalized by the forward count, and multiplied by 100. Ideally, the forward and reverse counts would be identical, resulting in a percent error of 0%. The average percent error for all twenty-three experiments was about 3.3%, which is similar to the percent error of about 2.9% in the previous implementation that did not have a red blood cell lysis and quenching module (Table 2). This shows that the differential counting chip with the addition of the red blood cell lysis and quenching modules results in a feasible device that can analyze unprocessed whole blood samples with low inherent error--making it practical for the use as a portable diagnostic device.

35 **OTHER IMPLEMENTATIONS**

[0114] It is to be understood that while the invention has been described in conjunction with the detailed description thereof, the foregoing description is intended to illustrate and not limit the scope of the invention, which is defined by the scope of the independent claims. Other aspects, advantages, and modifications are within the scope of the dependent claims.

Claims

45 **1.** A device (100) comprising:

a microfluidic chip defining a channel (112) including an inlet and an outlet;
 a capture chamber (116) arranged along the channel between the inlet and the outlet, wherein the capture chamber is configured to capture particles of interest from fluid flowing through the channel, wherein the capture chamber includes surfaces functionalized or coated with binding agents or binding moieties selected to specifically bind to the particles; **characterized in that** it further comprises
 a first electrical differential counter (110) arranged to count all types of particles in a fluid flowing into the capture chamber;
 a second electrical differential counter (111) arranged to count all types of particles remaining in the fluid flowing out of the capture chamber; and
 a computing mechanism (130, 132) in electronic communication with the first and second electrical differential counters, wherein the computing mechanism calculates a number of particles of interest based on signals from the first and second electrical differential counters.

2. A device (100) comprising:

5 a microfluidic chip defining a channel (112) including an inlet and an outlet;
a capture chamber (116) arranged along the channel between the inlet and the outlet, wherein the chamber is
configured to capture particles of interest from fluid flowing through the channel, wherein the chamber includes
surfaces functionalized or coated with binding agents or binding moieties selected to specifically bind to the
particles; **characterized in that** it further comprises
an electrical differential counter (110) arranged to count all types of particles in a fluid flowing into the capture
chamber and all types of particles remaining in the fluid flowing out of the capture chamber; and
10 a computing mechanism (130, 132) in electronic communication with the electrical differential counter, wherein
the computing mechanism calculates a number of particles of interest based on signals from the electrical
differential counter.

15 3. The device of claim 2, further comprising a pump system in fluid communication with the channel, wherein the pump
system is operable in a first mode to cause fluid to flow in a first direction in the channel past the first electrical
differential counter and operable in a second mode to cause fluid to flow in a second direction in the channel opposite
the first direction and back to the first electrical differential counter.

20 4. The device of claim 2,
wherein a portion of the channel defines a flow path that extends in a loop from the same electrical differential
counter through the capture chamber and back to the same electrical differential counter.

5. A kit comprising:

25 a device of claim 1 or 2;
a solution comprising a binding moiety with an affinity for the particles of interest; and
a solution comprising a lysing agent effective to lyse selected particles without lysing the particles of interest.

6. The kit of claim 5, wherein:

30 the device is the device of claim 2; and
the kit further comprises a pump system in fluid communication with the channel, wherein the pump system is
operable in a first mode to cause fluid to flow in a first direction in the channel past the first electrical differential
counter and operable in a second mode to cause fluid to flow in a second direction in the channel opposite the
35 first direction back to the first electrical differential counter.

7. A method of counting particles of interest in a sample that comprises two or more different types of particles using
the device of claim 1, the method comprising:

40 obtaining a fluid sample that may contain particles of interest;
counting all types of particles in a portion of the sample using a first electrical differential counter to generate a
first total;
removing any particles of interest from the portion of the fluid sample, wherein the particles of interest are
removed from the portion of the fluid sample using one or more binding agents or moieties that specifically binds
45 to a specific surface marker on the particle of interest, the binding agents or moieties functionalized or coated
on surfaces of the capture chamber;
counting any particles remaining in the portion of the fluid sample using a second electrical differential counter
after the particles of interest are removed to generate a second total; and
calculating a number of particles of interest originally in the fluid sample by subtracting the second total from
50 the first total, wherein the difference is the number of particles of interest in the sample.

8. A method of counting particles of interest in a sample that comprises two or more different types of particles using
the device of claim 2, the method comprising:

55 obtaining a fluid sample that may contain particles of interest;
counting all types of particles in a portion of the sample using an electrical differential counter to generate a first
total;
removing any particles of interest from the portion of the fluid sample, wherein the particles of interest are

removed from the portion of the fluid sample using one or more binding agents or moieties that specifically binds to a specific surface marker on the particle of interest, the binding agents or moieties functionalized or coated on surfaces of the capture chamber;
 counting any particles remaining in the portion of the fluid sample using the electrical differential counter after the particles of interest are removed to generate a second total; and
 calculating a number of particles of interest originally in the fluid sample by subtracting the second total from the first total, wherein the difference is the number of particles of interest in the sample.

5

10

9. The method of claim 8, further comprising reversing a flow direction of the fluid sample after removing the particles of interest from the portion of the fluid sample.

10. The method of claim 8, further comprising maintaining a flow direction of the fluid sample while counting all types of particles in the portion of the sample and counting any particles remaining in the portion of the fluid sample.

15

11. The method of claim 8, wherein the fluid sample comprises whole blood and the method comprises depleting erythrocytes by lysis, or wherein the fluid sample comprises whole blood and the method comprises depleting erythrocytes, monocytes, neutrophils, CD8+ lymphocytes, or other cellular components of blood by immunodepletion.

20

12. The method of claim 8, further comprising determining a cell flow direction based on a polarity of an impulse signal generated by the first electrical differential counter.

Patentansprüche

25

1. Vorrichtung (100), umfassend:

einen Mikrofluidikchip, der einen Kanal (112) definiert, der einen Einlass und einen Auslass aufweist;
 eine Abscheidungskammer (116), die entlang des Kanals zwischen dem Einlass und dem Auslass angeordnet ist, wobei die Abscheidungskammer dafür gestaltet ist, Partikel von Interesse aus Fluid, das durch den Kanal fließt, abzuscheiden, wobei die Abscheidungskammer Oberflächen aufweist, die mit Bindemitteln oder Bindeeinheiten, die zum spezifischen Binden an die Partikel ausgewählt sind, funktionalisiert oder beschichtet sind;
dadurch gekennzeichnet, dass sie ferner umfasst:

30

einen ersten elektrischen Differenzzähler (110), der dafür gestaltet ist, alle Typen von Partikeln in einem Fluid zu zählen, das in die Abscheidungskammer fließt;
 einen zweiten elektrischen Differenzzähler (111), der dafür gestaltet ist, alle Typen von Partikeln zu zählen, die in dem Fluid verbleiben, das aus der Abscheidungskammer abfließt; und
 einen Rechenmechanismus (130, 132) in elektronischer Verbindung mit dem ersten und dem zweiten elektrischen Differenzzähler, wobei der Rechenmechanismus die Anzahl von Partikeln von Interesse auf der Grundlage von Signalen von dem ersten und dem zweiten elektrischen Differenzzähler berechnet.

35

40

2. Vorrichtung (100), umfassend:

einen Mikrofluidikchip, der einen Kanal (112) definiert, der einen Einlass und einen Auslass aufweist;
 eine Abscheidungskammer (116), die entlang des Kanals zwischen dem Einlass und dem Auslass angeordnet ist, wobei die Kammer dafür gestaltet ist, Partikel von Interesse aus Fluid, das durch den Kanal fließt, abzuscheiden, wobei die Kammer Oberflächen aufweist, die mit Bindemitteln oder Bindeeinheiten, die zum spezifischen Binden an die Partikel ausgewählt sind, funktionalisiert oder beschichtet sind;
dadurch gekennzeichnet, dass sie ferner umfasst:

45

50

einen elektrischen Differenzzähler (110), der dafür gestaltet ist, alle Typen von Partikeln in einem Fluid, das in die Abscheidungskammer fließt, und alle Typen von Partikeln, die in dem Fluid verbleiben, das aus der Abscheidungskammer abfließt, zu zählen; und
 einen Rechenmechanismus (130, 132) in elektronischer Verbindung mit dem elektrischen Differenzzähler, wobei der Rechenmechanismus die Anzahl von Partikeln von Interesse auf der Grundlage von Signalen von dem elektrischen Differenzzähler berechnet.

55

3. Vorrichtung gemäß Anspruch 2, ferner umfassend ein Pumpsystem in Fluidverbindung mit dem Kanal, wobei das Pumpsystem in einem ersten Modus funktionsfähig ist, zu bewirken, dass Fluid in eine erste Richtung in dem Kanal über den ersten elektrischen Differenzzähler hinaus fließt, und in einem zweiten Modus funktionsfähig ist, zu bewirken, dass Fluid in eine zweite Richtung in dem Kanal, die der ersten Richtung entgegengesetzt ist, zurück zu dem ersten elektrischen Differenzzähler fließt.
- 5
4. Vorrichtung gemäß Anspruch 2, wobei ein Teil des Kanals einen Flussweg definiert, der in einer Schleife von dem gleichen elektrischen Differenzzähler durch die Abscheidungskammer und zurück zu dem gleichen elektrischen Differenzzähler verläuft.
- 10
5. Kit, umfassend:
- eine Vorrichtung gemäß Anspruch 1 oder 2;
eine Lösung, die eine Bindeeinheit mit einer Affinität für die Partikel von Interesse umfasst; und
eine Lösung, die ein Lysemittel umfasst, das wirksam ist, ausgewählte Partikel zu lysieren, ohne die Partikel von Interesse zu lysieren.
- 15
6. Kit gemäß Anspruch 5, wobei:
- 20 die Vorrichtung die Vorrichtung gemäß Anspruch 2 ist; und
das Kit ferner ein Pumpsystem in Fluidverbindung mit dem Kanal umfasst, wobei das Pumpsystem in einem ersten Modus funktionsfähig ist, zu bewirken, dass Fluid in eine erste Richtung in dem Kanal über den ersten elektrischen Differenzzähler hinaus fließt, und in einem zweiten Modus funktionsfähig ist, zu bewirken, dass Fluid in eine zweite Richtung in dem Kanal, die der ersten Richtung entgegengesetzt ist, zurück zu dem ersten elektrischen Differenzzähler fließt.
- 25
7. Verfahren zum Zählen von Partikeln von Interesse in einer Probe, die zwei oder mehr verschiedene Typen von Partikeln umfasst, unter Verwendung der Vorrichtung gemäß Anspruch 1, wobei das Verfahren umfasst:
- 30 Gewinnen einer Fluidprobe, die Partikel von Interesse enthalten kann;
Zählen aller Typen von Partikeln in einem Teil der Probe unter Verwendung eines ersten elektrischen Differenzzählers, um eine erste Summe zu erhalten;
Entfernen der Partikel von Interesse aus dem Teil der Fluidprobe, wobei die Partikel von Interesse unter Verwendung eines oder mehrerer Bindemittel oder -einheiten, die spezifisch an einen spezifischen Oberflächenmarker an dem Partikel von Interesse binden, aus dem Teil der Fluidprobe entfernt werden, wobei die Bindemittel oder -einheiten auf Oberflächen der Abscheidungskammer funktionalisiert oder geschichtet sind;
35 Zählen der Partikel, die in dem Teil der Fluidprobe verbleiben, unter Verwendung eines zweiten elektrischen Differenzzählers, nachdem die Partikel von Interesse entfernt worden sind, um eine zweite Summe zu erhalten; und
40 Berechnen der ursprünglichen Zahl von Partikeln von Interesse in der Fluidprobe durch Subtrahieren der zweiten Summe von der ersten Summe, wobei die Differenz die Anzahl von Partikeln von Interesse in der Probe ist.
8. Verfahren zum Zählen von Partikeln von Interesse in einer Probe, die zwei oder mehr verschiedene Typen von Partikeln umfasst, unter Verwendung der Vorrichtung gemäß Anspruch 2, wobei das Verfahren umfasst:
- 45 Gewinnen einer Fluidprobe, die Partikel von Interesse enthalten kann;
Zählen aller Typen von Partikeln in einem Teil der Probe unter Verwendung eines elektrischen Differenzzählers, um eine erste Summe zu erhalten;
Entfernen der Partikel von Interesse aus dem Teil der Fluidprobe, wobei die Partikel von Interesse unter Verwendung eines oder mehrerer Bindemittel oder -einheiten, die spezifisch an einen spezifischen Oberflächenmarker an dem Partikel von Interesse binden, aus dem Teil der Fluidprobe entfernt werden, wobei die Bindemittel oder -einheiten auf Oberflächen der Abscheidungskammer funktionalisiert oder geschichtet sind;
50 Zählen der Partikel, die in dem Teil der Fluidprobe verbleiben, unter Verwendung des elektrischen Differenzzählers, nachdem die Partikel von Interesse entfernt worden sind, um eine zweite Summe zu erhalten; und
55 Berechnen der ursprünglichen Zahl von Partikeln von Interesse in der Fluidprobe durch Subtrahieren der zweiten Summe von der ersten Summe, wobei die Differenz die Anzahl von Partikeln von Interesse in der Probe ist.
9. Verfahren gemäß Anspruch 8, ferner umfassend Umkehren der Flussrichtung der Fluidprobe nach dem Entfernen

der Partikel von Interesse aus dem Teil der Fluidprobe.

- 5
10. Verfahren gemäß Anspruch 8, ferner umfassend Halten der Flussrichtung der Fluidprobe während des Zählens aller Typen von Partikeln in dem Teil der Probe und des Zählens der Partikel, die in dem Teil der Fluidprobe verbleiben.
11. Verfahren gemäß Anspruch 8, wobei die Fluidprobe Vollblut umfasst und das Verfahren Abbauen von Erythrozyten durch Lyse umfasst oder wobei die Fluidprobe Vollblut umfasst und das Verfahren Abbauen von Erythrozyten, Monozyten, Neutrophilen, CD8⁺-Lymphozyten oder anderen zellulären Blutkomponenten durch Immundepletion umfasst.
12. Verfahren gemäß Anspruch 8, ferner umfassend Bestimmen der Zellenflussrichtung auf der Grundlage der Polarität eines Impulssignals, das von dem ersten elektrischen Differenzähler erzeugt wird.
- 10

15 **Revendications**

1. Dispositif (100) comprenant :

20 une puce microfluidique définissant un canal (112) comportant une entrée et une sortie ;
une chambre de capture (116) disposée le long du canal entre l'entrée et la sortie, la chambre de capture étant configurée pour capturer des particules d'intérêt à partir d'un fluide circulant à travers le canal, la chambre de capture comportant des surfaces fonctionnalisées ou recouvertes avec des agents de liaison ou des fractions de liaison sélectionnés pour se lier spécifiquement aux particules ; **caractérisé en ce qu'il** comprend en outre un premier compteur différentiel électrique (110) configuré pour compter tous les types de particules dans un fluide circulant jusqu'à l'intérieur la chambre de capture ;
25 un deuxième compteur différentiel électrique (111) configuré pour compter tous les types de particules restant dans le fluide circulant jusqu'à l'extérieur de la chambre de capture ; et
un mécanisme informatique (130, 132) en communication électronique avec les premier et deuxième compteurs différentiels électriques, le mécanisme informatique calculant un nombre de particules d'intérêt en se basant sur des signaux provenant des premier et deuxième compteurs différentiels électriques.

30

2. Dispositif (100) comprenant :

35 une puce microfluidique définissant un canal (112) comportant une entrée et une sortie ;
une chambre de capture (116) disposée le long du canal entre l'entrée et la sortie, la chambre étant configurée pour capturer des particules d'intérêt à partir d'un fluide circulant à travers le canal, la chambre comportant des surfaces fonctionnalisées ou recouvertes avec des agents de liaison ou des fractions de liaison sélectionnés pour se lier spécifiquement aux particules ; **caractérisé en ce qu'il** comprend en outre un compteur différentiel électrique (110) configuré pour compter tous les types de particules dans un fluide circulant jusqu'à l'intérieur de la chambre de capture et tous les types de particules restant dans le fluide circulant jusqu'à l'extérieur de la chambre de capture ; et
40 un mécanisme informatique (130, 132) en communication électronique avec le compteur différentiel électrique, le mécanisme informatique calculant un nombre de particules d'intérêt en se basant sur des signaux provenant du compteur différentiel électrique.

45

3. Dispositif de la revendication 2, comprenant en outre un système de pompage en communication fluide avec le canal, le système de pompage étant utilisable dans un premier mode pour faire circuler un fluide dans le canal dans une première direction au-delà du premier compteur différentiel électrique et utilisable dans un deuxième mode pour faire circuler un fluide dans le canal dans une deuxième direction opposée à la première direction et le faire retourner au premier compteur différentiel électrique.

50

4. Dispositif de la revendication 2, dans lequel une partie du canal définit un passage qui s'étend en une boucle depuis le même compteur différentiel électrique à travers la chambre de capture et de nouveau jusqu'au même compteur différentiel électrique.

55

5. Trousse comprenant :

un dispositif de la revendication 1 ou 2 ;

une solution comprenant une fraction de liaison avec une affinité pour les particules d'intérêt ; et
une solution comprenant un agent de lyse efficace pour lyser des particules sélectionnées sans lyser les particules d'intérêt.

5 6. Trousse de la revendication 5, dans laquelle :

le dispositif est le dispositif de la revendication 2 ; et
la trousse comprend en outre un système de pompage en communication fluidique avec le canal, le système
de pompage étant utilisable dans un premier mode pour faire circuler un fluide dans le canal dans une première
10 direction au-delà du premier compteur différentiel électrique et utilisable dans un deuxième mode pour faire
circuler un fluide dans le canal dans une deuxième direction opposée à la première direction de nouveau
jusqu'au premier compteur différentiel électrique.

15 7. Procédé de comptage de particules d'intérêt dans un échantillon qui comprend au moins deux types différents de
particules au moyen du dispositif de la revendication 1, le procédé comprenant :

l'obtention d'un échantillon de fluide qui peut contenir des particules d'intérêt ;
le comptage de tous les types de particules dans une partie de l'échantillon au moyen d'un premier compteur
différentiel électrique pour générer un premier total ;
20 le retrait de toutes les particules d'intérêt de la partie de l'échantillon de fluide, les particules d'intérêt étant
retirées de la partie de l'échantillon de fluide au moyen d'un ou plusieurs agents ou fractions de liaison qui se
lient spécifiquement à un marqueur de surface spécifique sur la particule d'intérêt, les agents ou fractions de
liaison étant fonctionnalisés ou déposés sur des surfaces de la chambre de capture ;
le comptage de toutes les particules restant dans la partie de l'échantillon de fluide au moyen d'un deuxième
25 compteur différentiel électrique après que les particules d'intérêt ont été retirées pour générer un deuxième
total ; et
le calcul d'un nombre de particules d'intérêt initialement dans l'échantillon de fluide par soustraction du deuxième
total du premier total, la différence étant le nombre de particules d'intérêt dans l'échantillon.

30 8. Procédé de comptage de particules d'intérêt dans un échantillon qui comprend au moins deux types différents de
particules au moyen du dispositif de la revendication 2, le procédé comprenant :

l'obtention d'un échantillon de fluide qui peut contenir des particules d'intérêt ;
le comptage de tous les types de particules dans une partie de l'échantillon au moyen d'un compteur différentiel
35 électrique pour générer un premier total ;
le retrait de toutes les particules d'intérêt de la partie de l'échantillon de fluide, les particules d'intérêt étant
retirées de la partie de l'échantillon de fluide au moyen d'un ou plusieurs agents ou fractions de liaison qui se
lient spécifiquement à un marqueur de surface spécifique sur la particule d'intérêt, les agents ou fractions de
liaison étant fonctionnalisés ou déposés sur des surfaces de la chambre de capture ;
40 le comptage de toutes les particules restant dans la partie de l'échantillon de fluide au moyen du compteur
différentiel électrique après que les particules d'intérêt ont été retirées pour générer un deuxième total ; et
le calcul d'un nombre de particules d'intérêt initialement dans l'échantillon de fluide par soustraction du deuxième
total du premier total, la différence étant le nombre de particules d'intérêt dans l'échantillon.

45 9. Procédé de la revendication 8, comprenant en outre l'inversion d'une direction de circulation de l'échantillon de
fluide après le retrait des particules d'intérêt de la partie de l'échantillon de fluide.

50 10. Procédé de la revendication 8, comprenant en outre le maintien d'une direction de circulation de l'échantillon de
fluide pendant le comptage de tous les types de particules dans la partie de l'échantillon et le comptage de toutes
les particules restant dans la partie de l'échantillon de fluide.

11. Procédé de la revendication 8, l'échantillon de fluide comprenant du sang total et le procédé comprenant la sup-
pression des érythrocytes par lyse, ou
l'échantillon de fluide comprenant du sang total et le procédé comprenant la suppression des érythrocytes, mono-
55 cytes, neutrophiles, lymphocytes CD8+, ou d'autres composants cellulaires du sang par immunodéplétion.

12. Procédé de la revendication 8, comprenant en outre la détermination d'une direction de circulation de cellules sur
la base d'une polarité d'un signal d'impulsion généré par le premier compteur différentiel électrique.

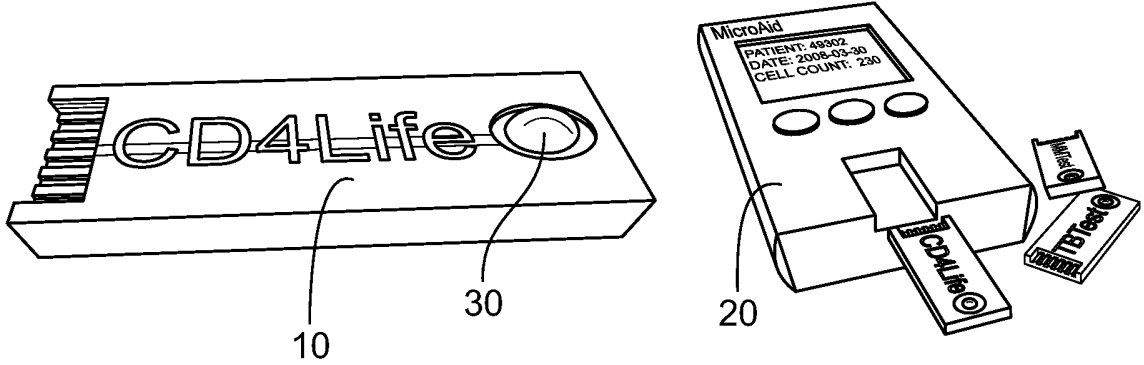
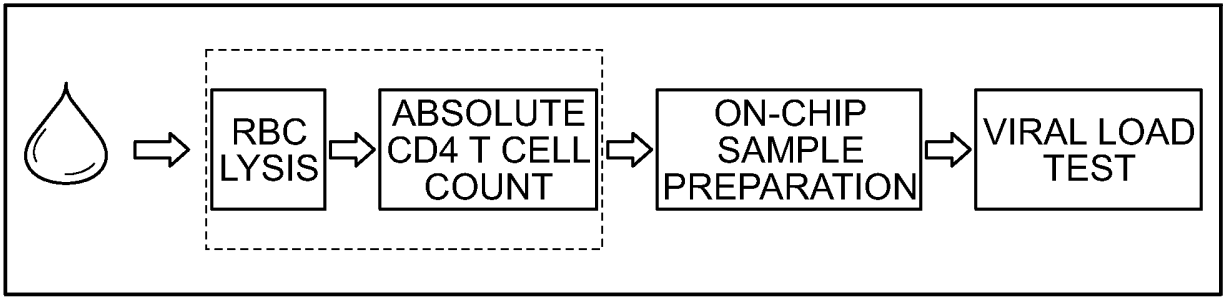

FIG. 1

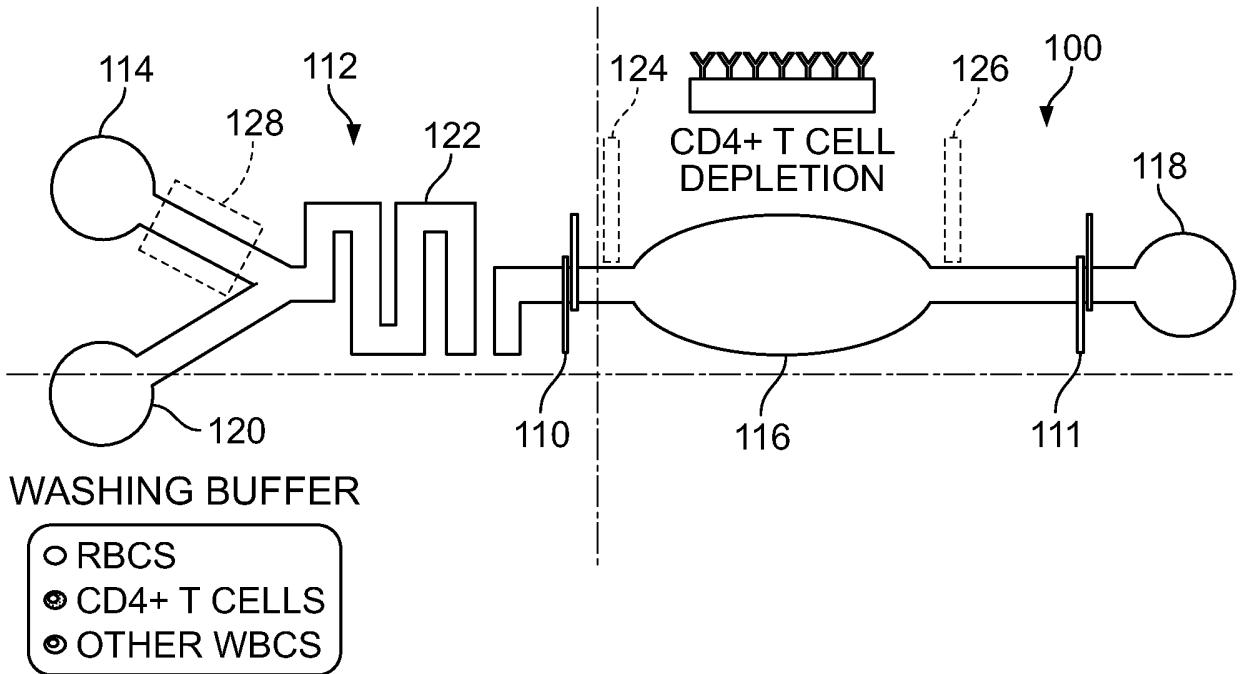

FIG. 2A

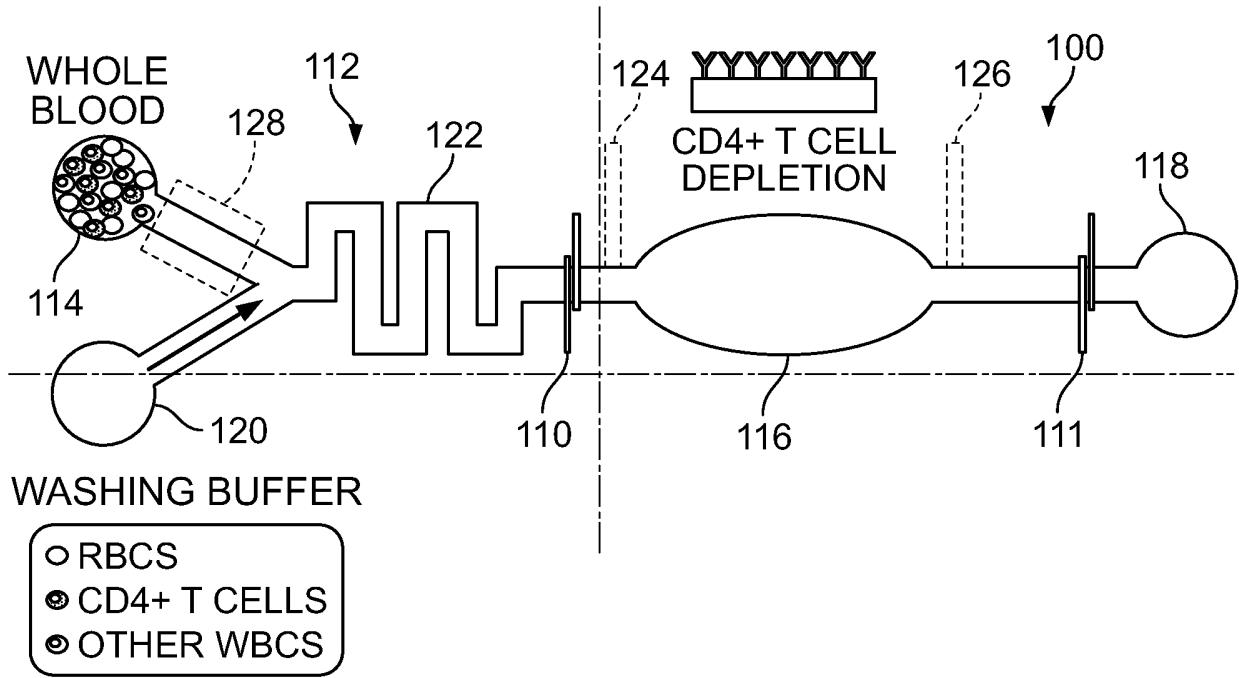

FIG. 2B

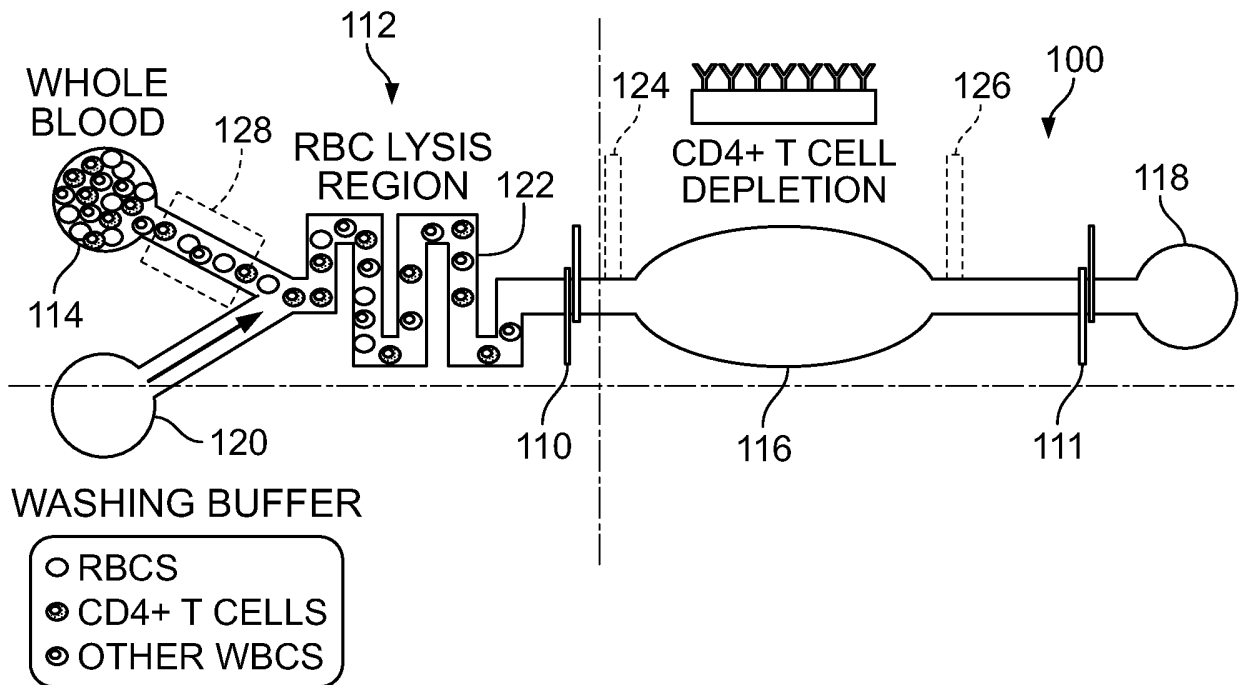

FIG. 2C

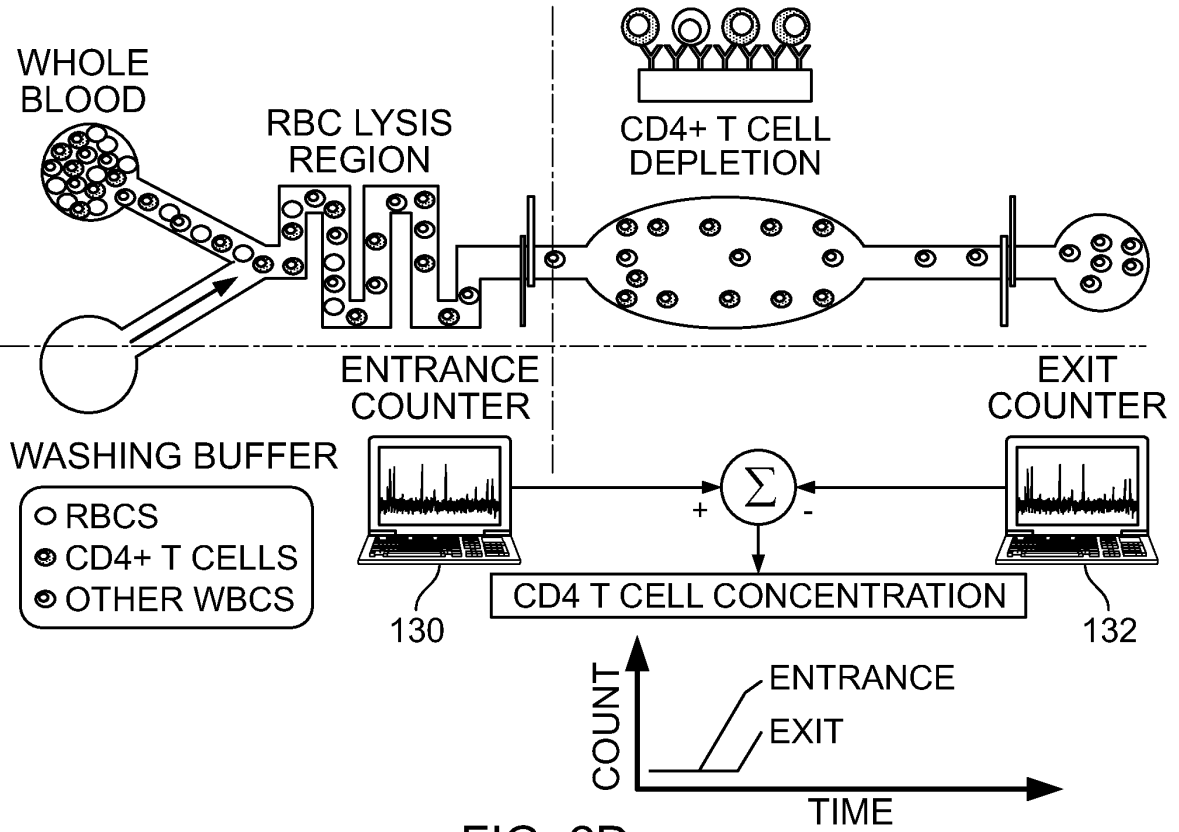

FIG. 2D

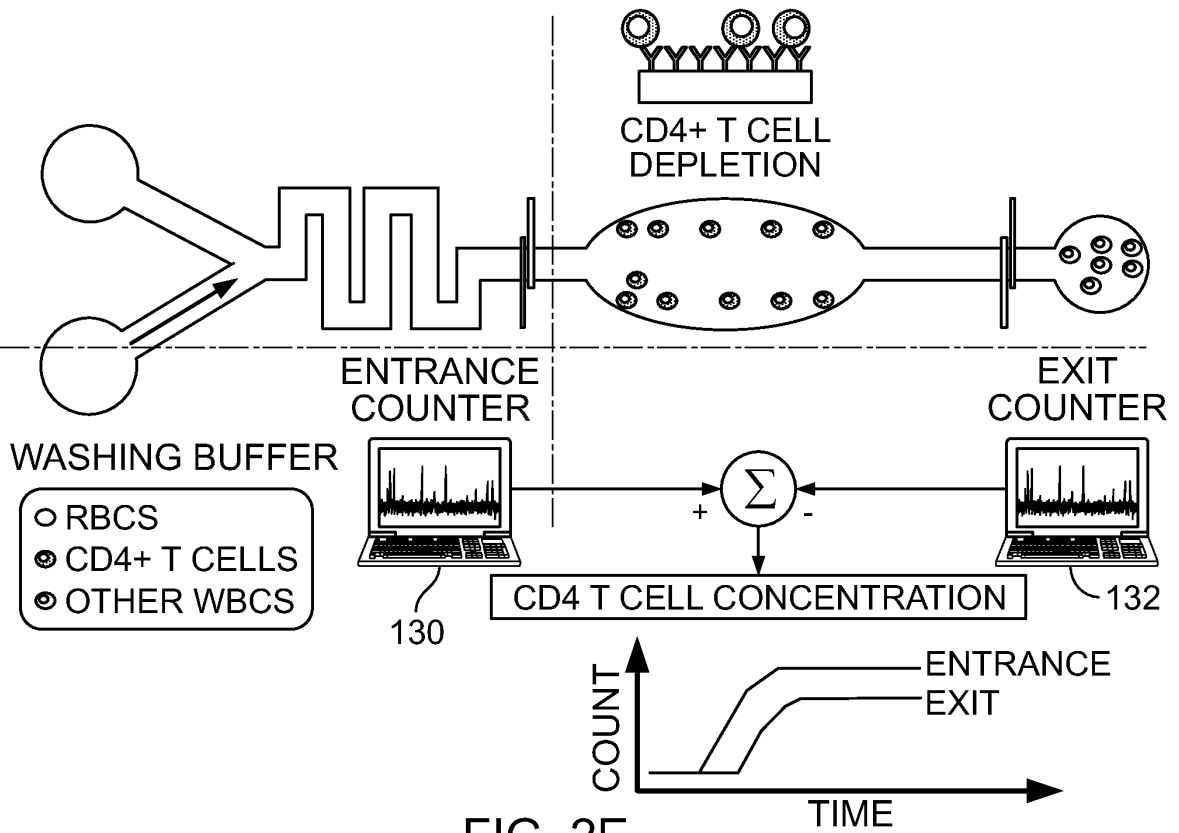

FIG. 2E

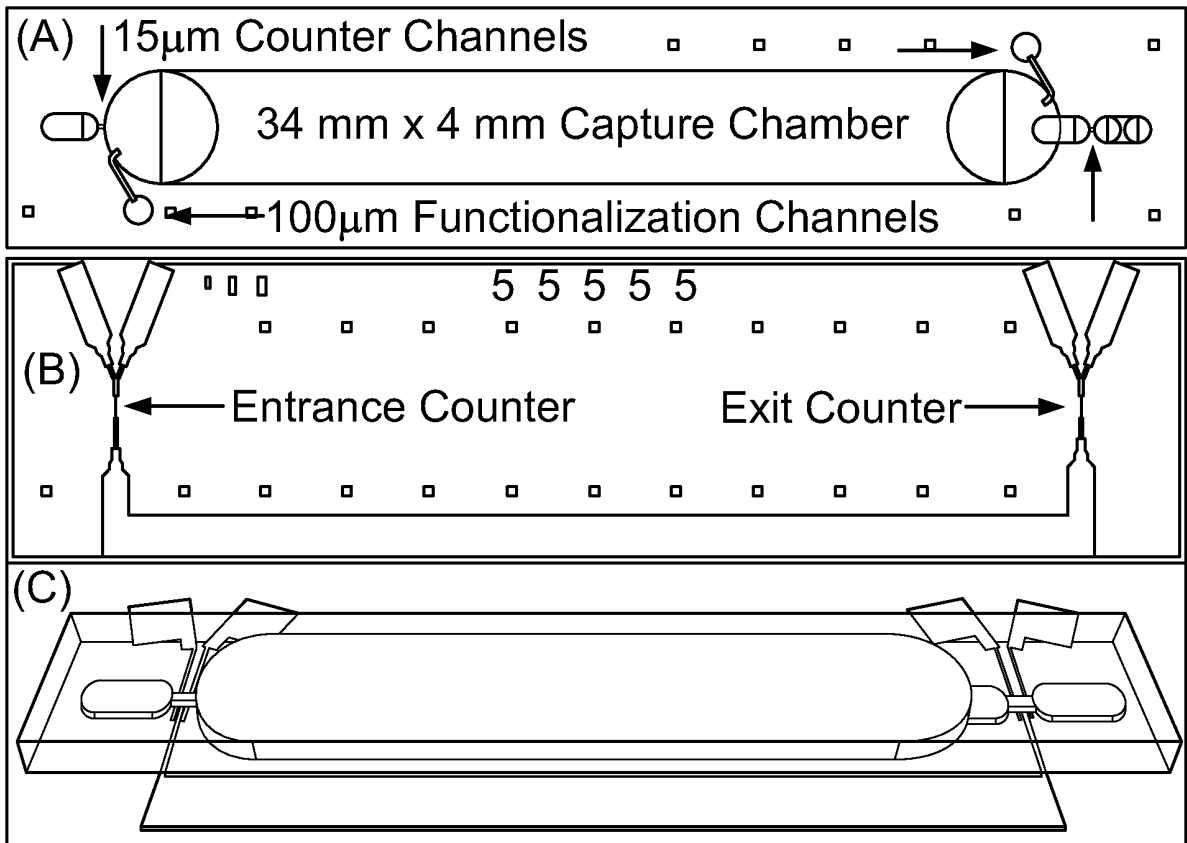

FIG. 3

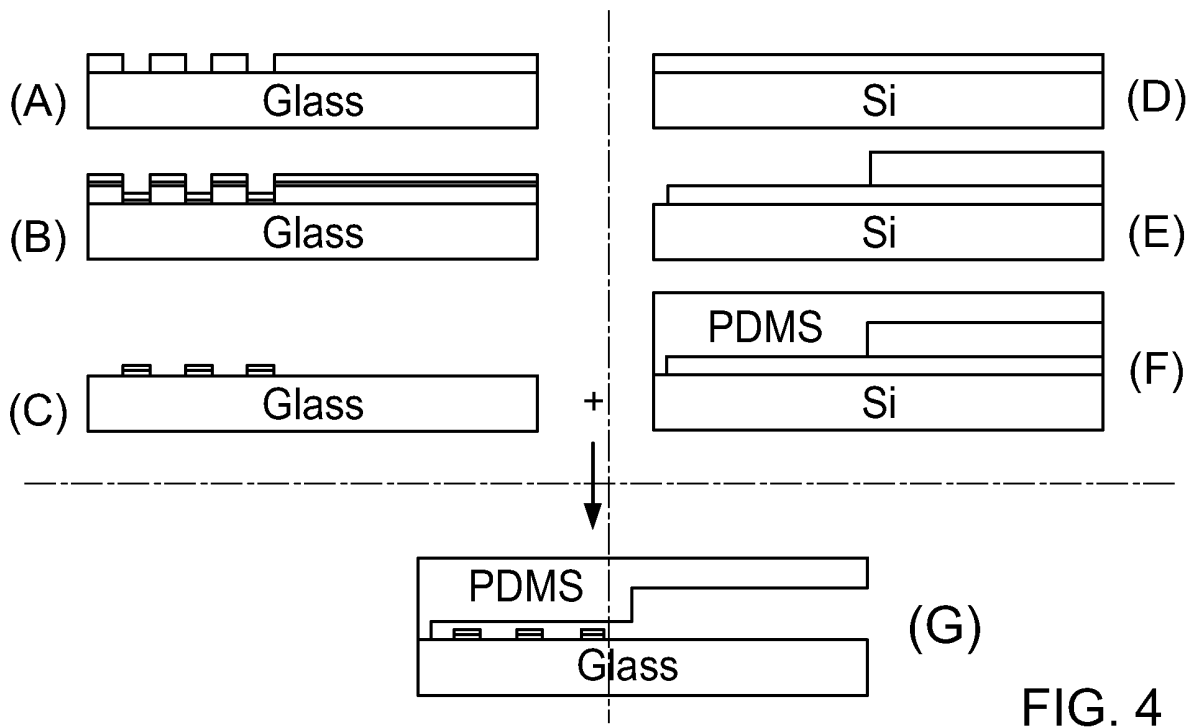

FIG. 4

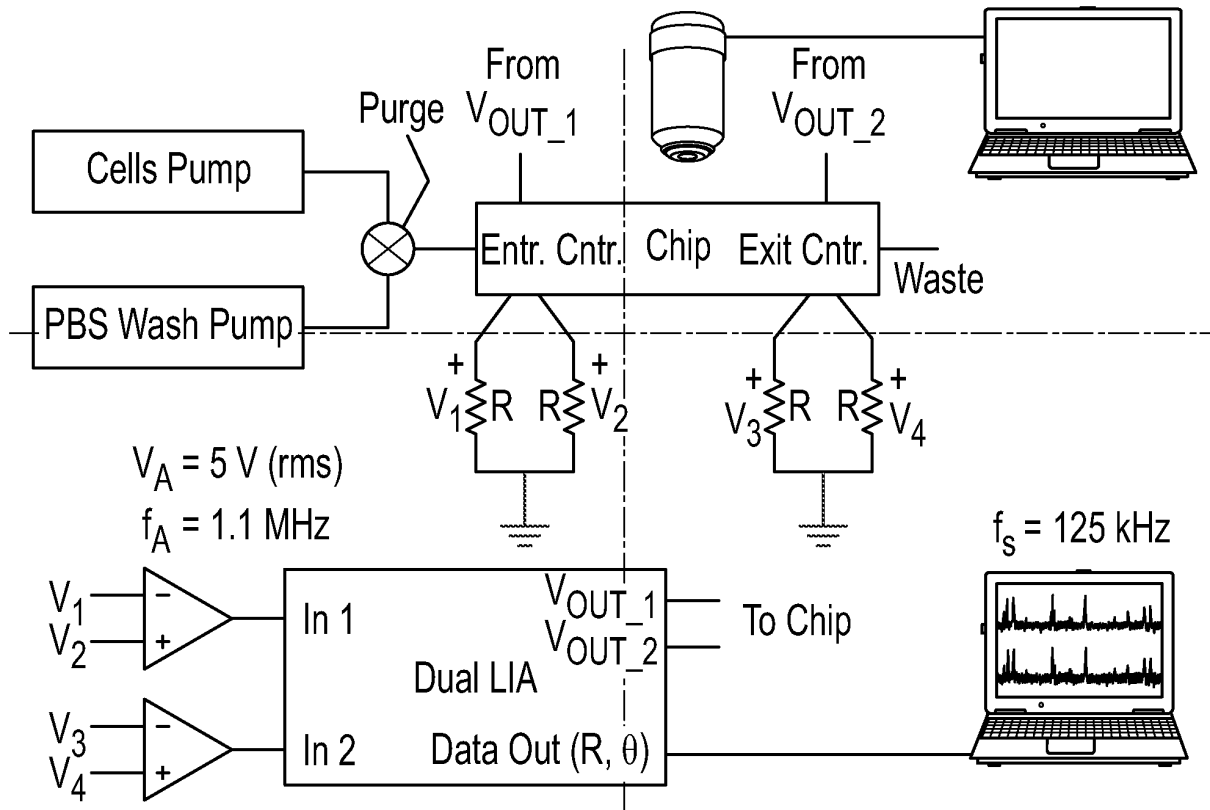

FIG. 5

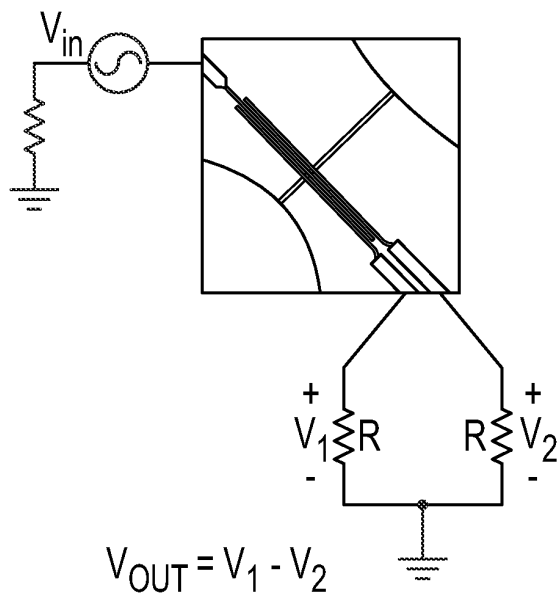

FIG. 6

Conc. Limit for Electrical Chip

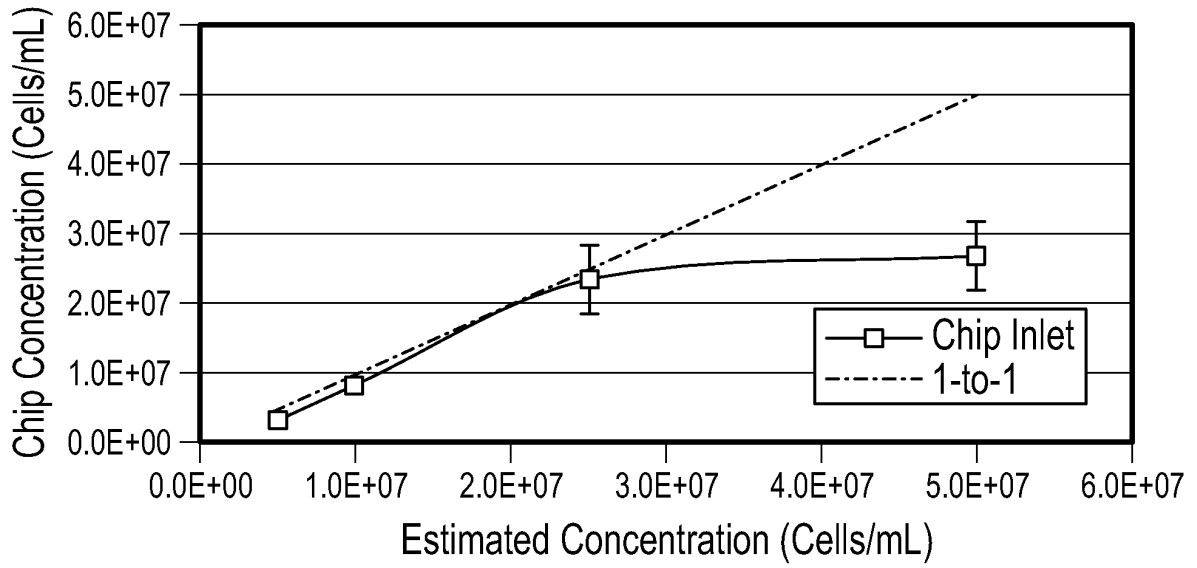

FIG. 7

Differential Counter Negative Control (1:1 Dilution, 10xSD)

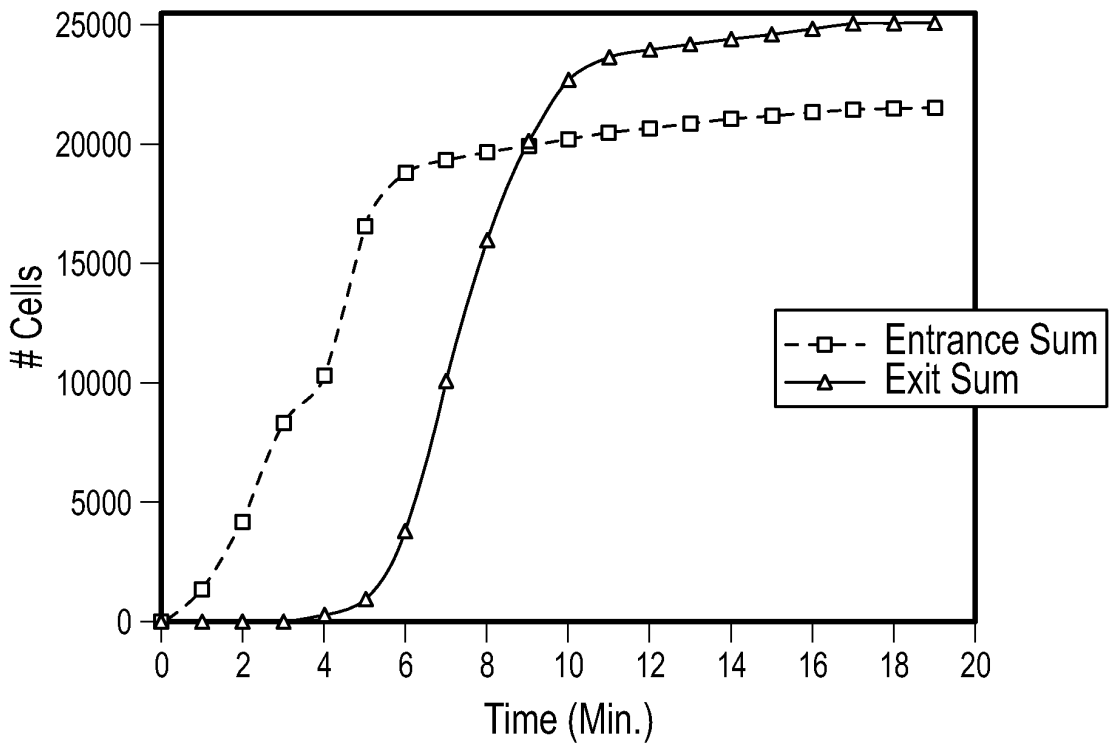

FIG. 8

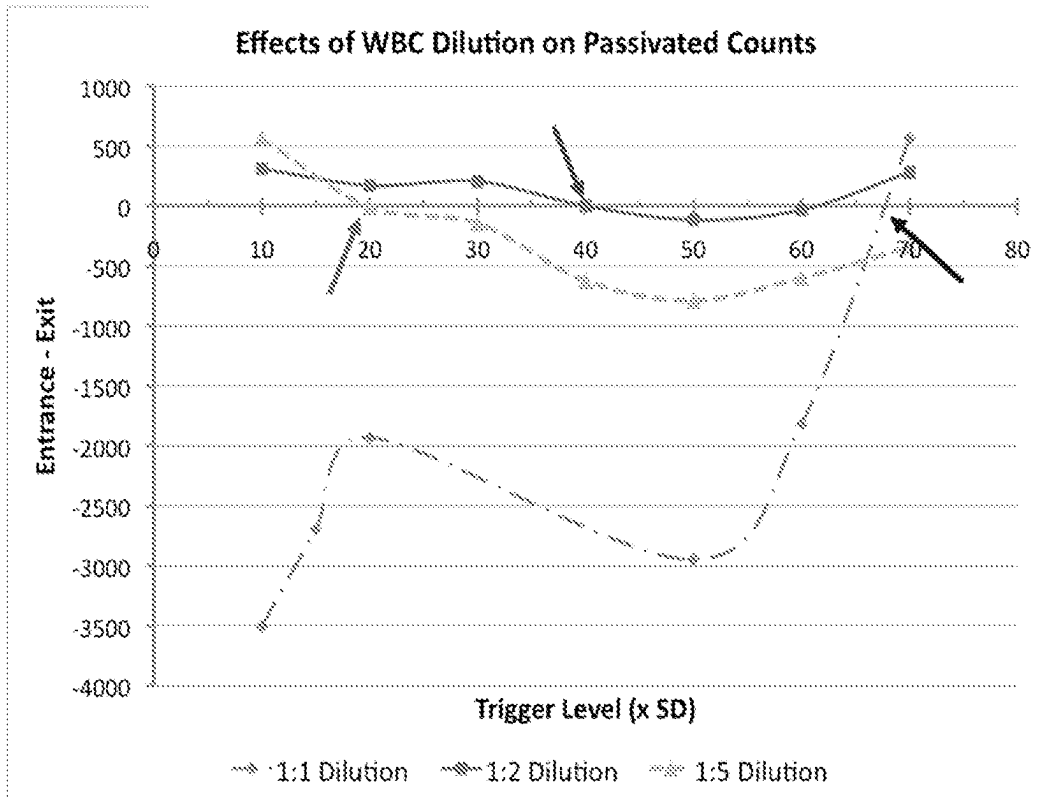

FIG. 9

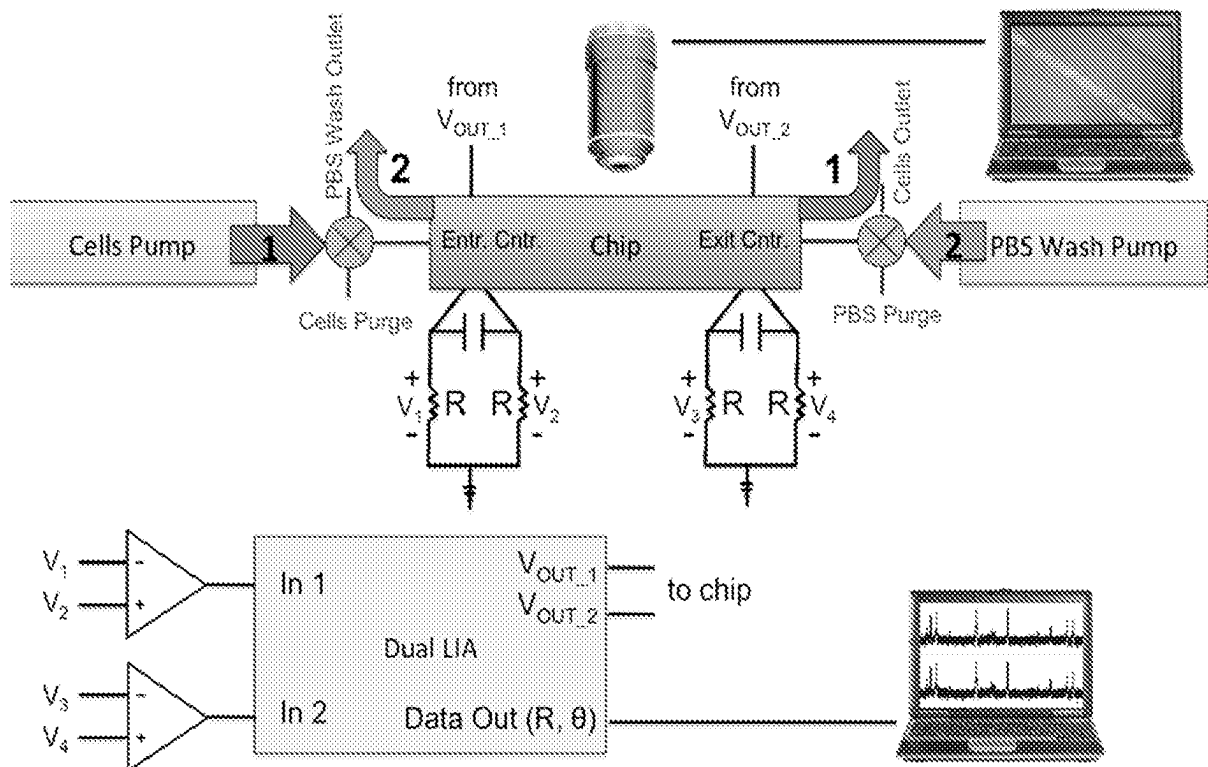

FIG. 11

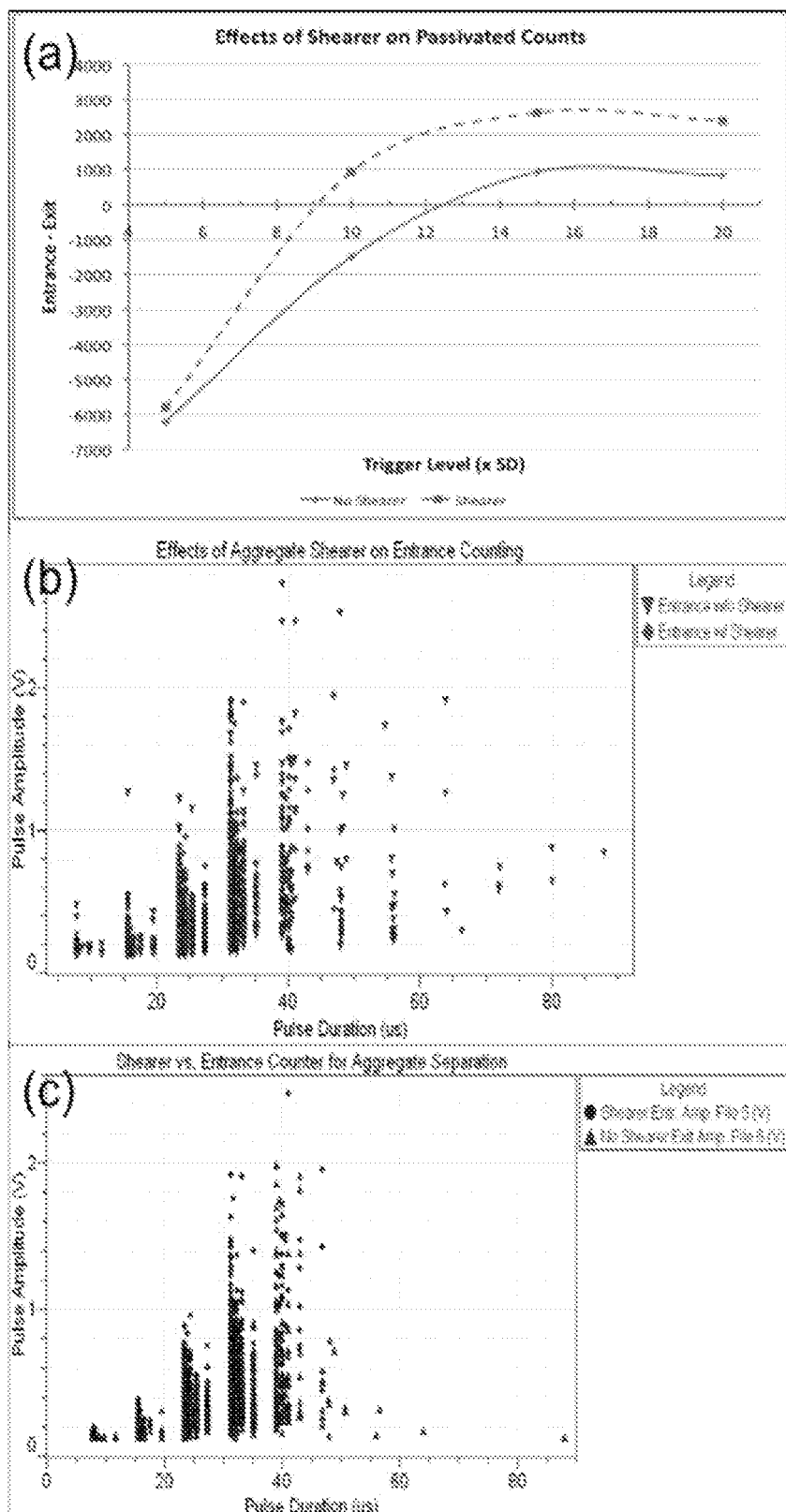

FIG. 10

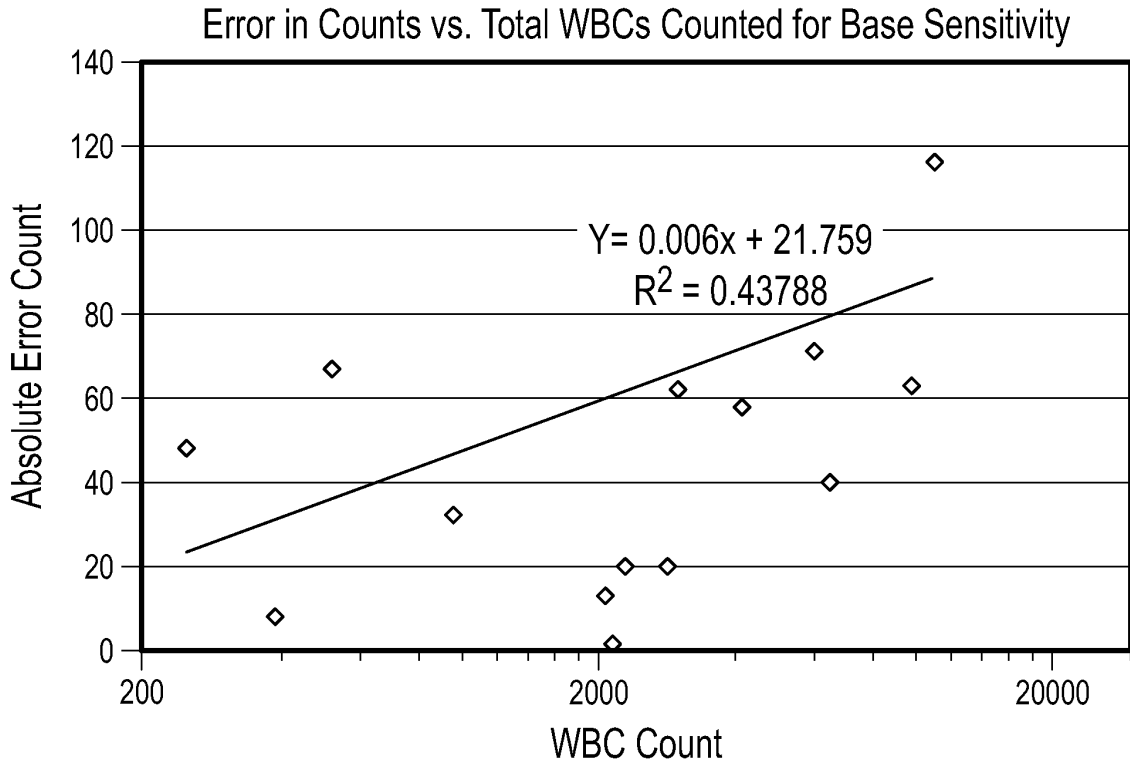

FIG. 12

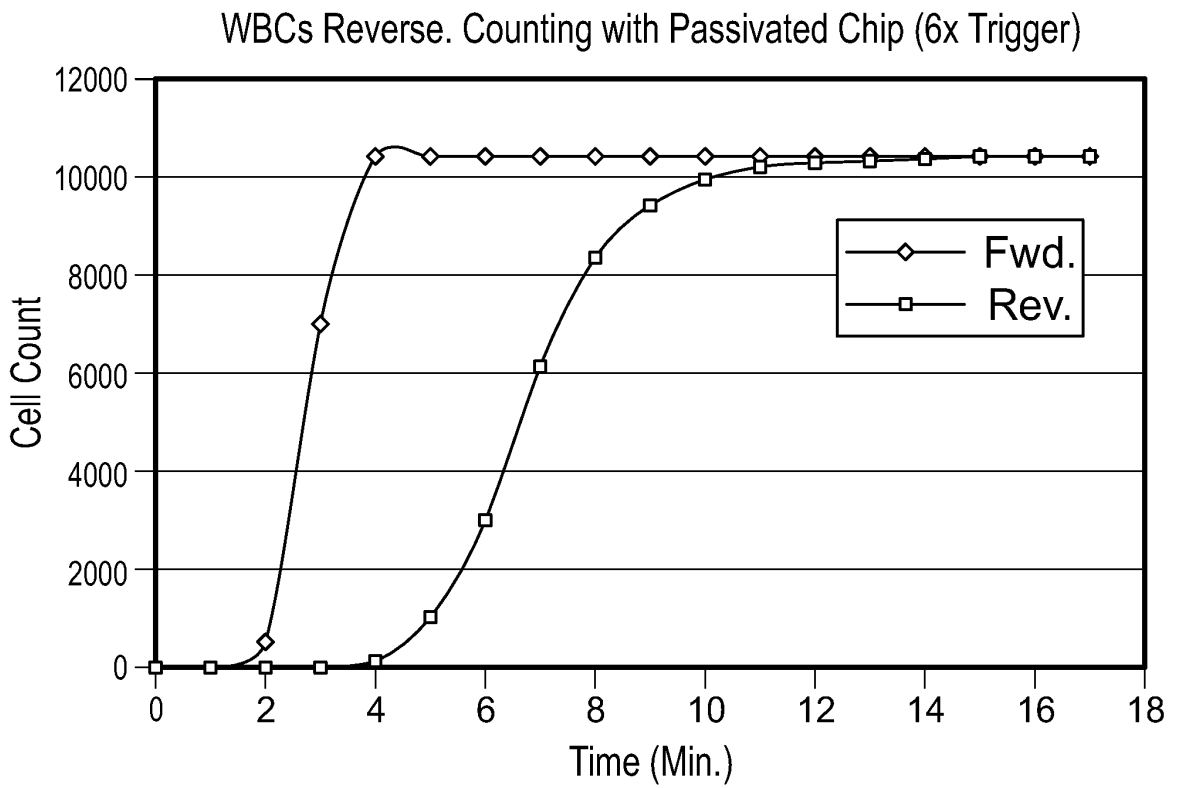

FIG. 13

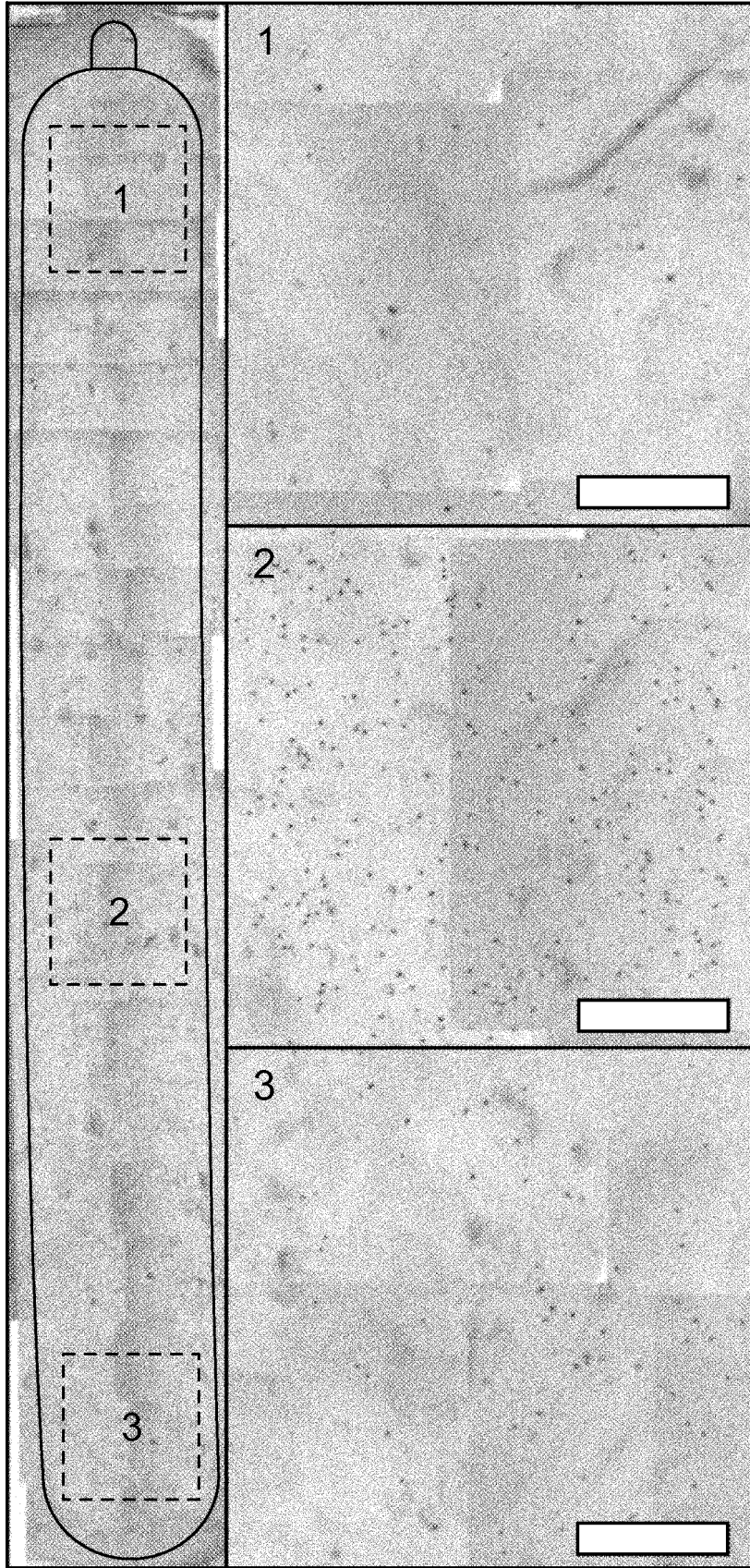

FIG. 14

Optical Counting of Captured CD4 T Cells

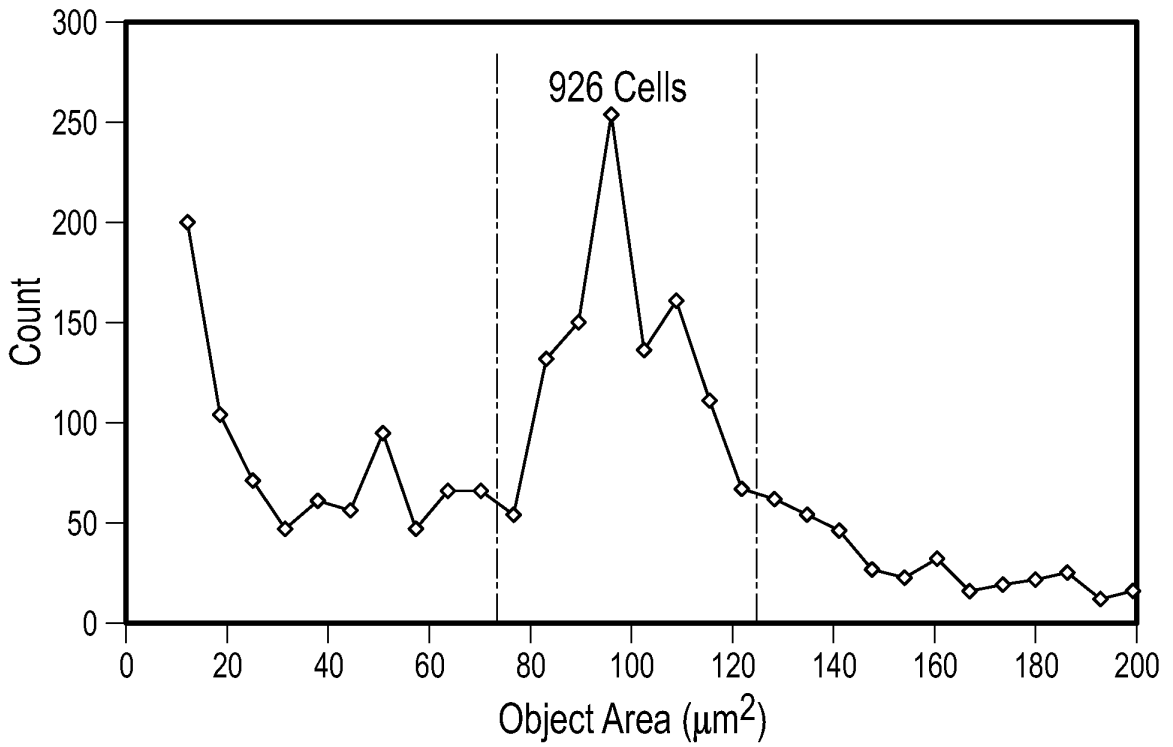

FIG. 15

CD4 T Cell Capture Count (5xSD Trigger)

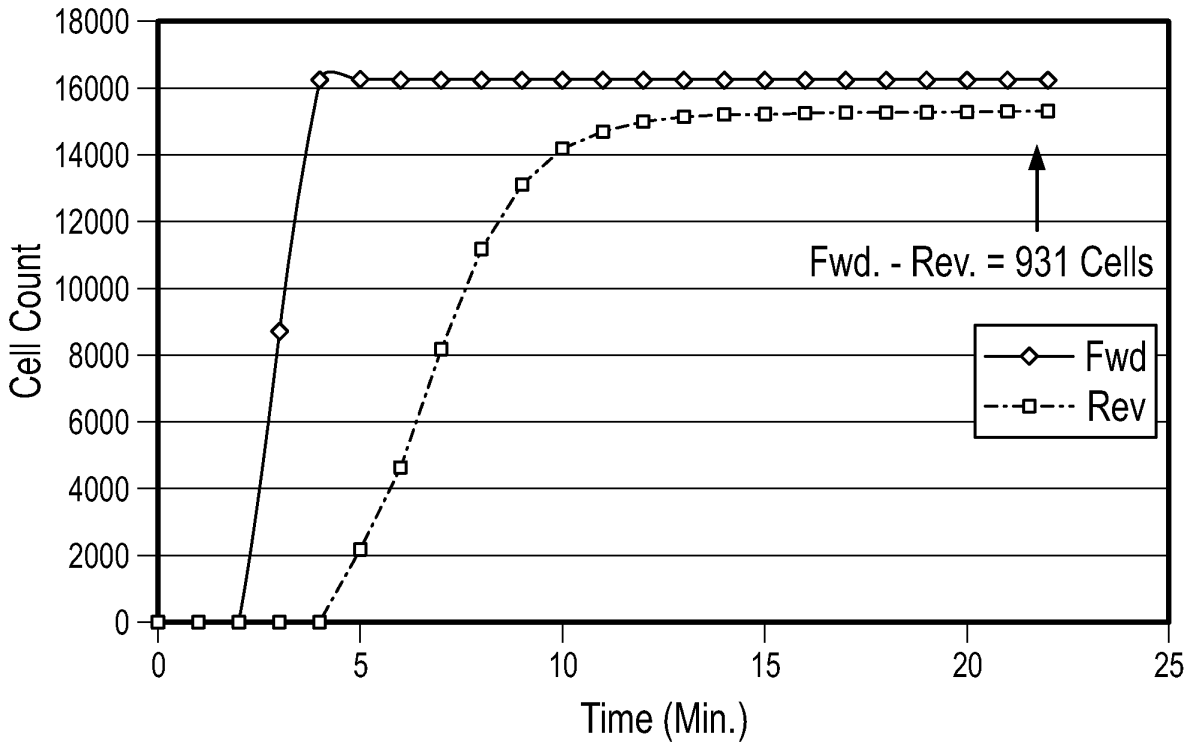

FIG. 16

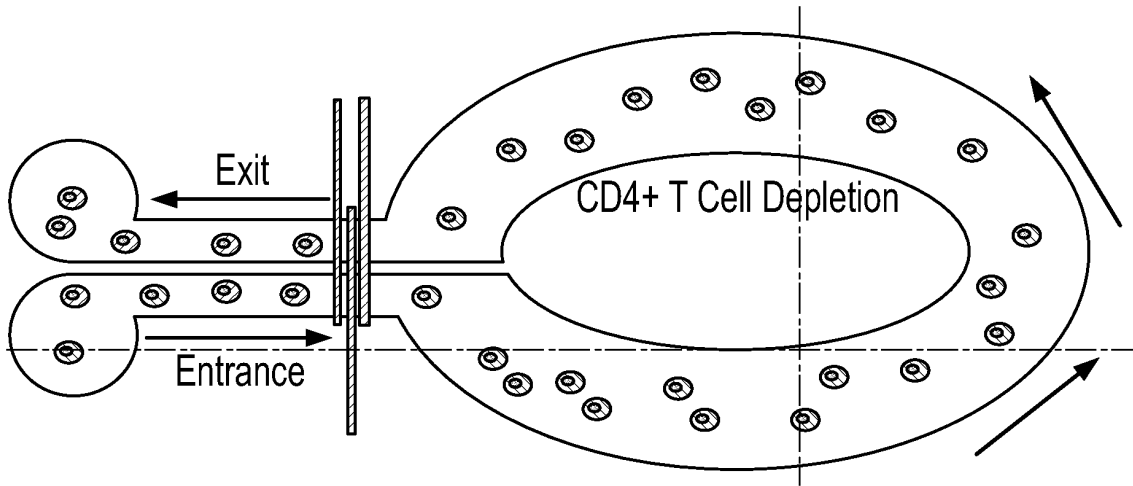

FIG. 17

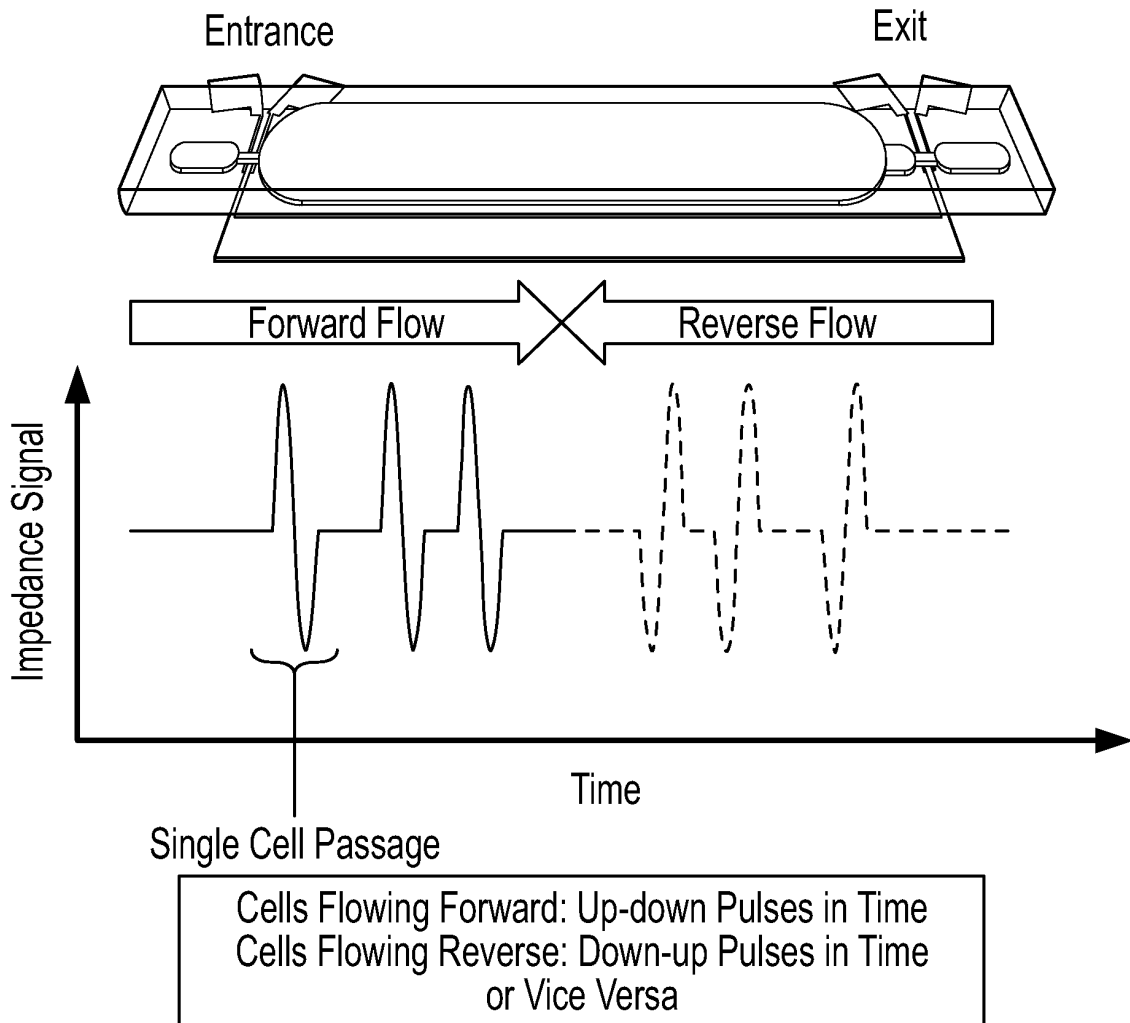

FIG. 18

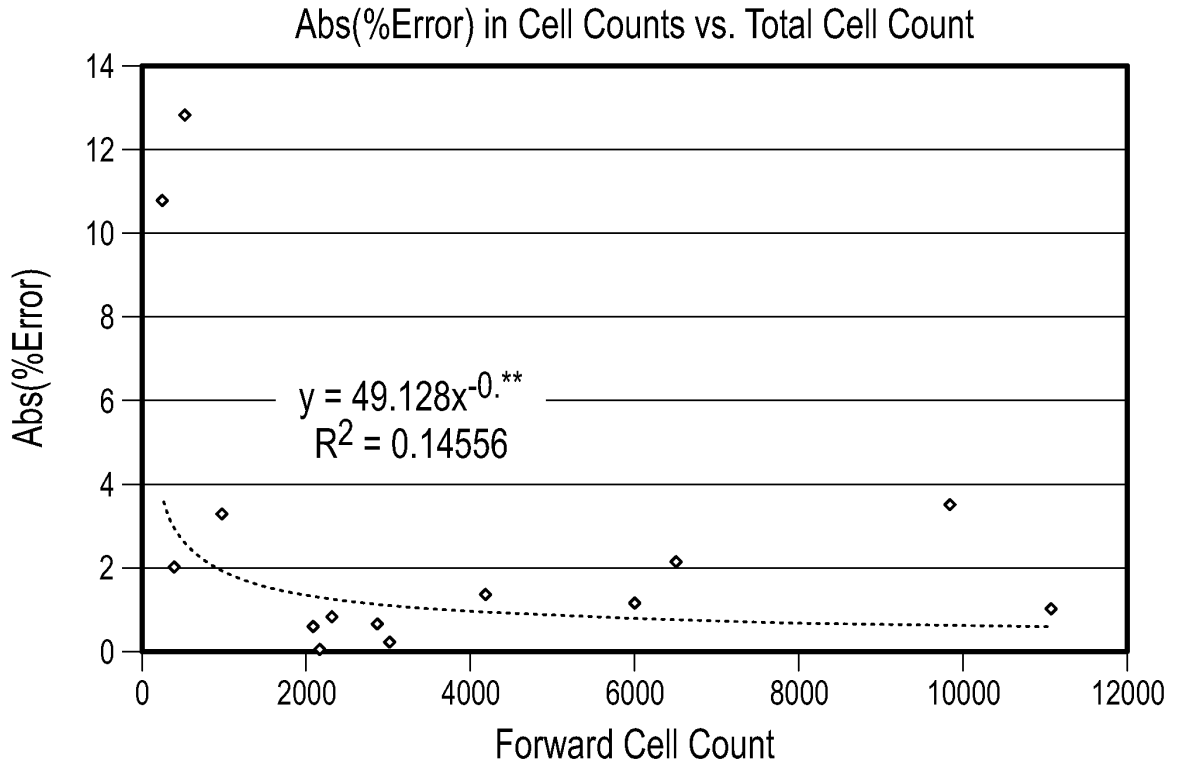

FIG. 19(A)

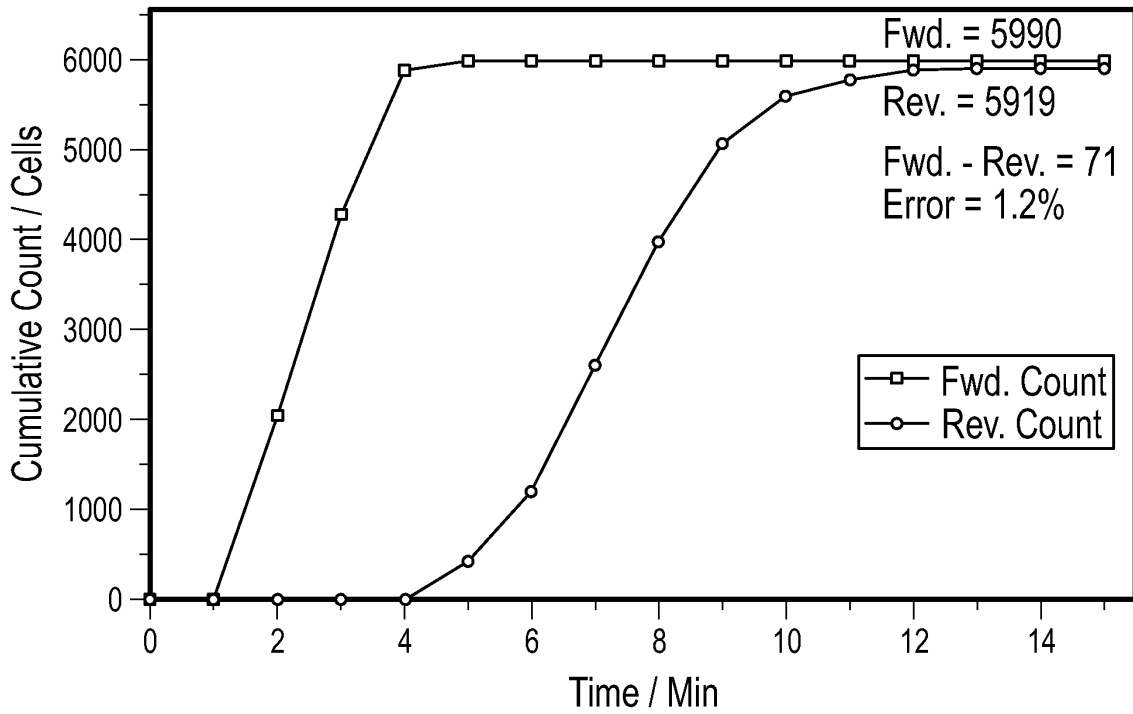

FIG. 19(B)

Electrical vs. Optical (Control) Counts

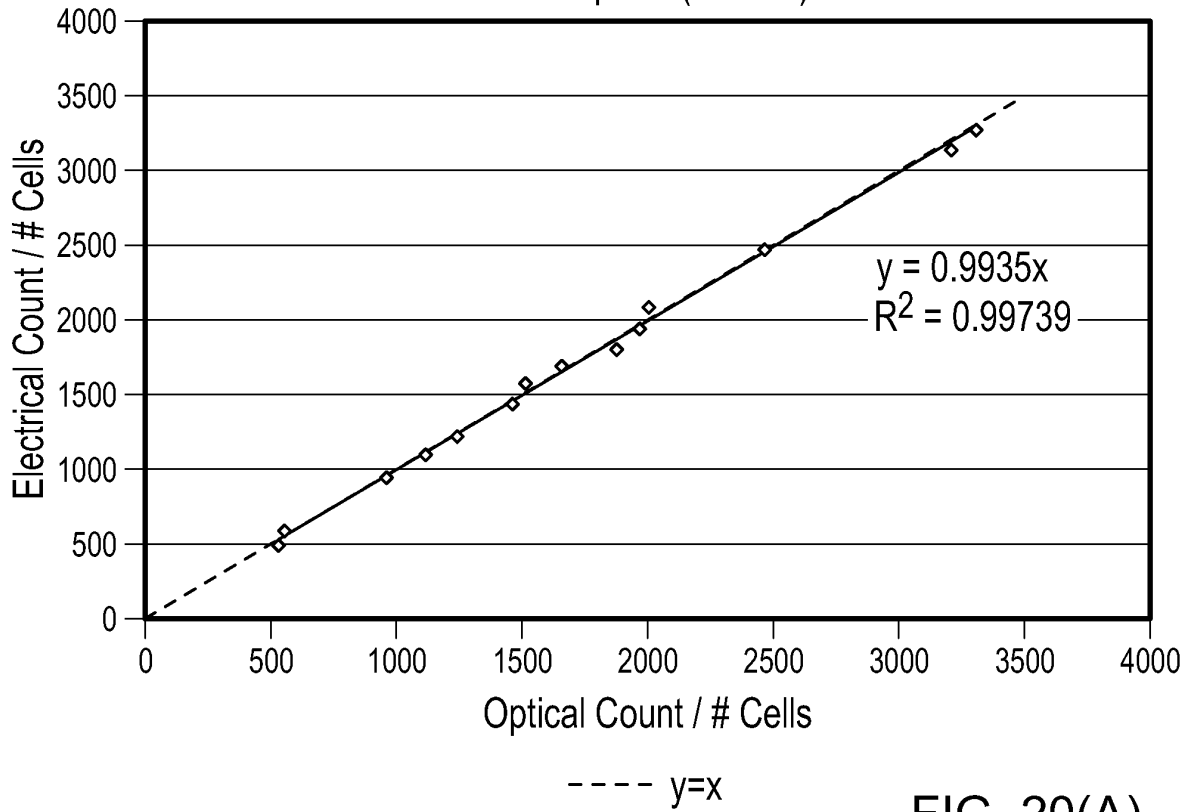

FIG. 20(A)

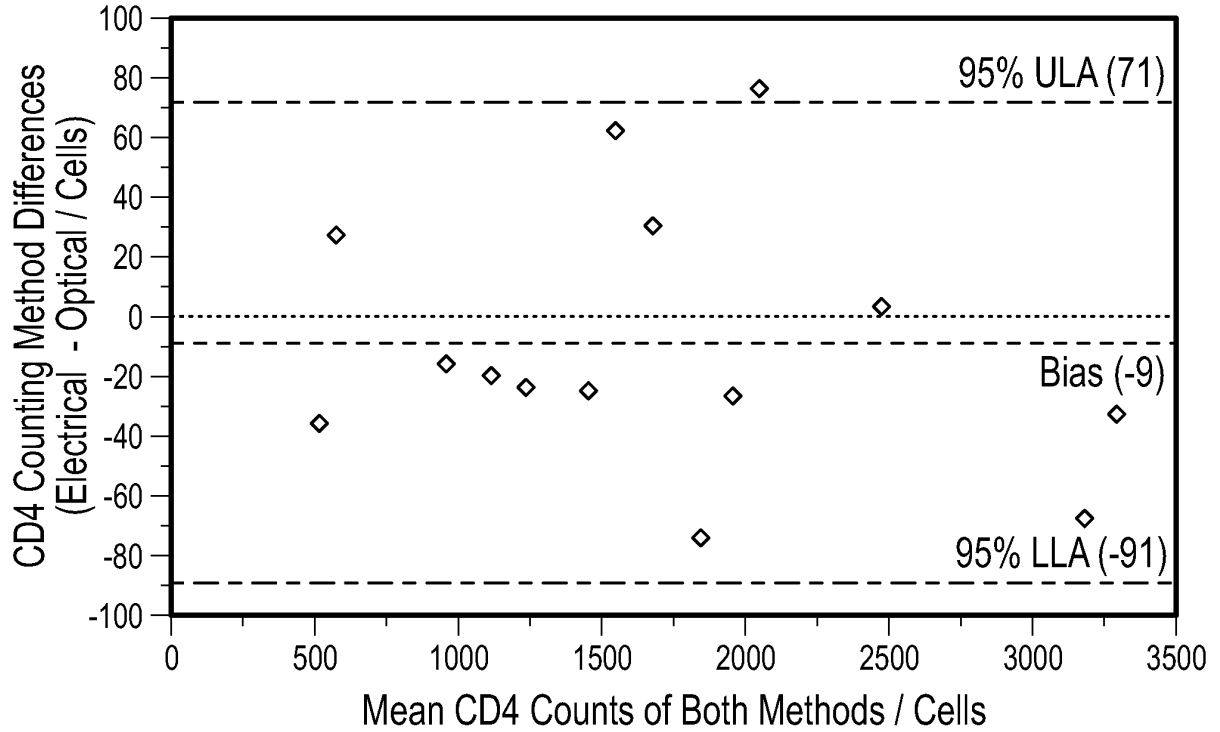

FIG. 20(B)

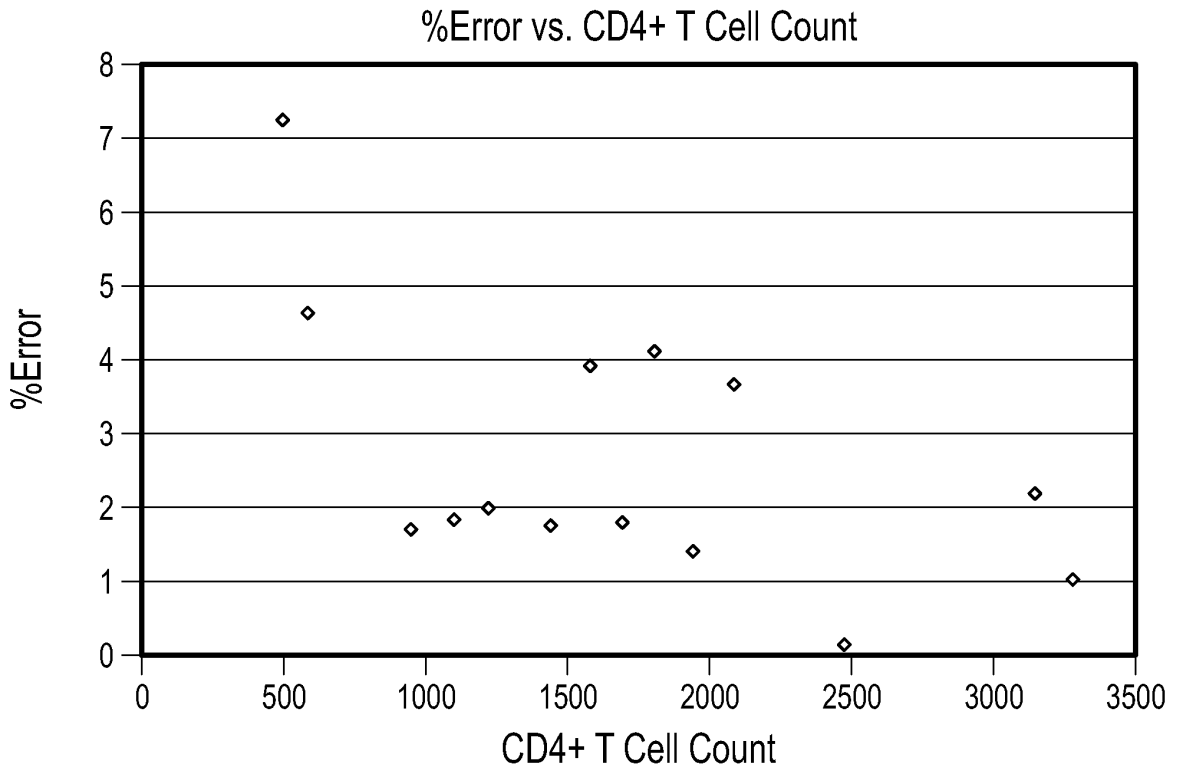

FIG. 21

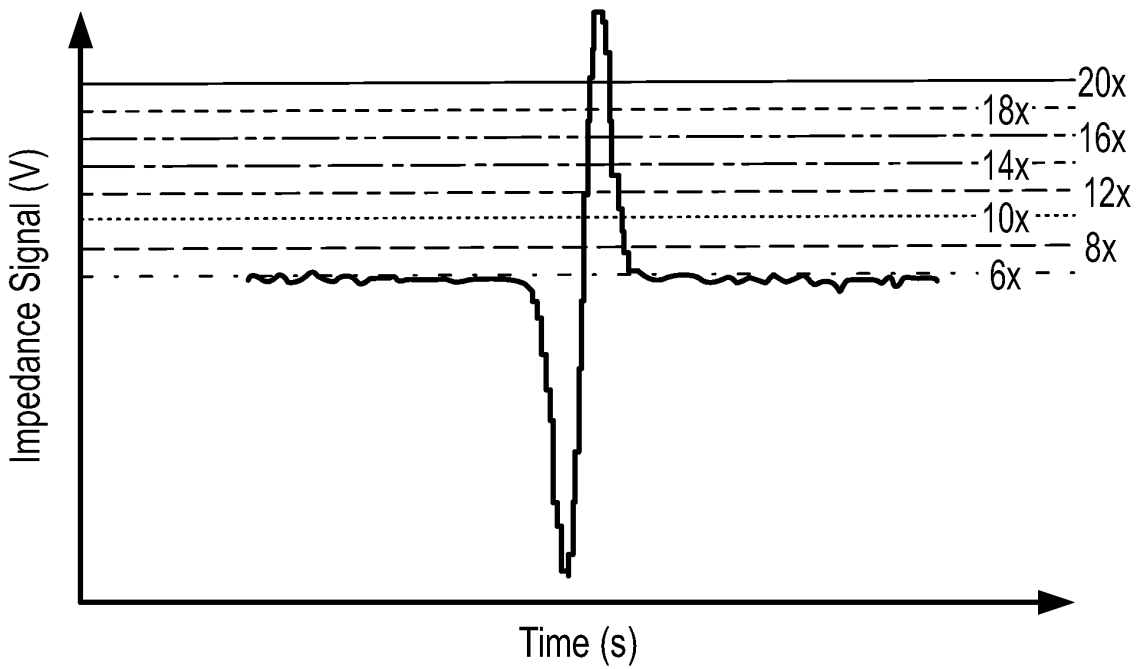

FIG. 22

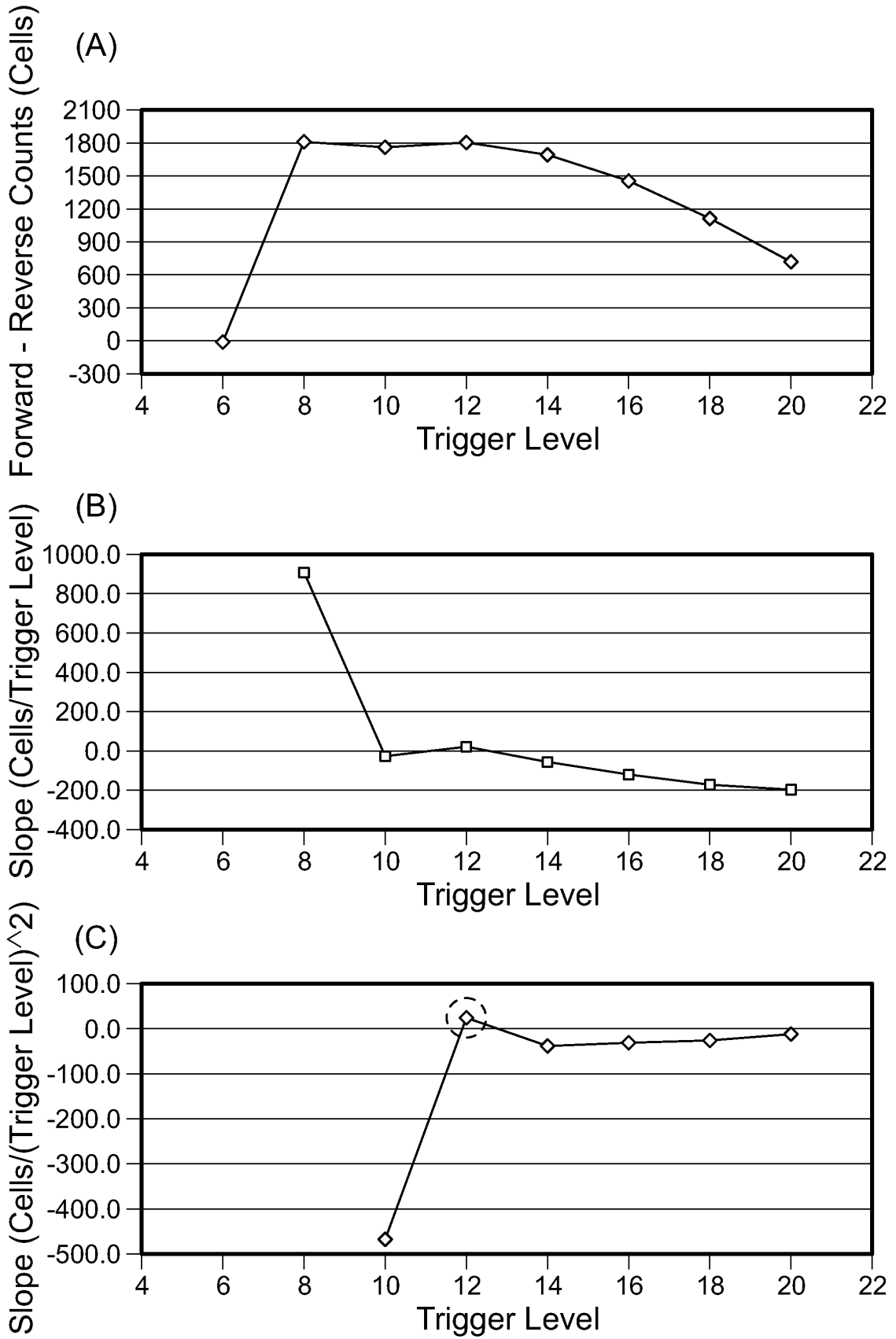

FIG. 23

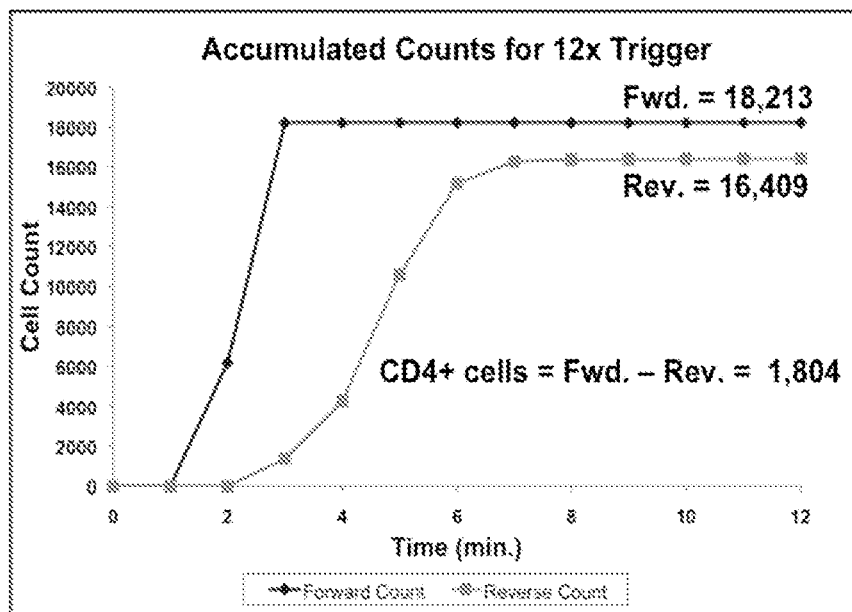

FIG. 24

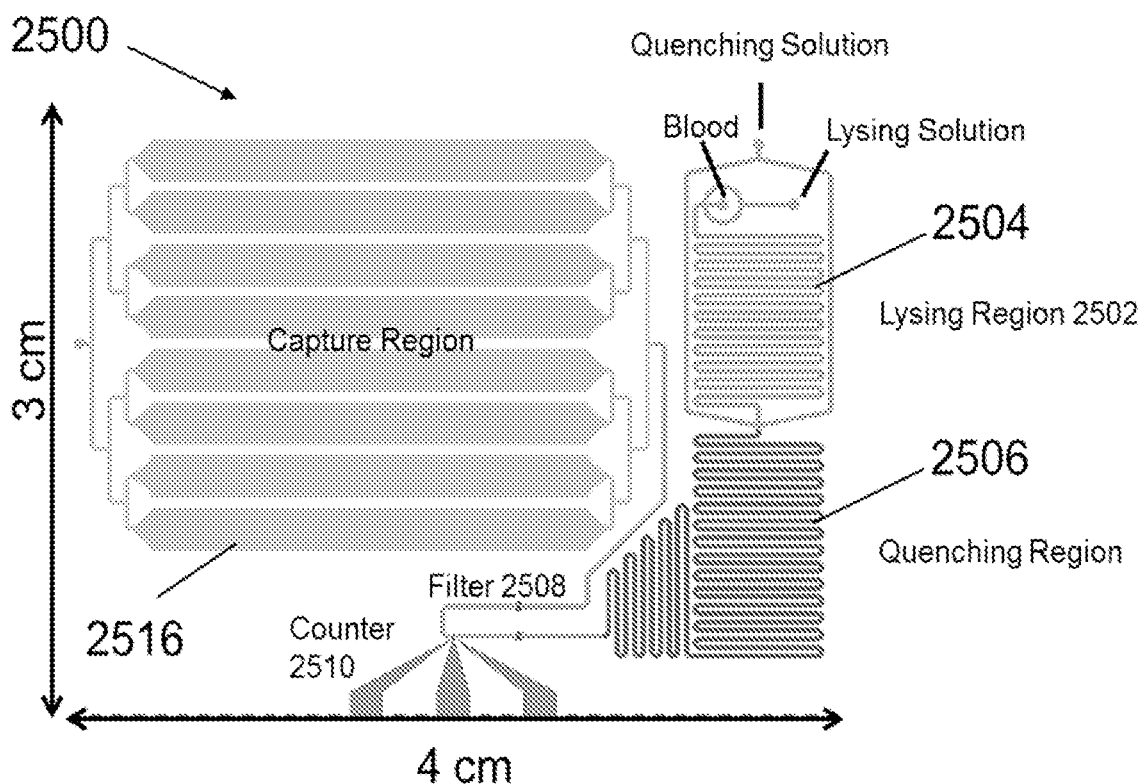

FIG. 25

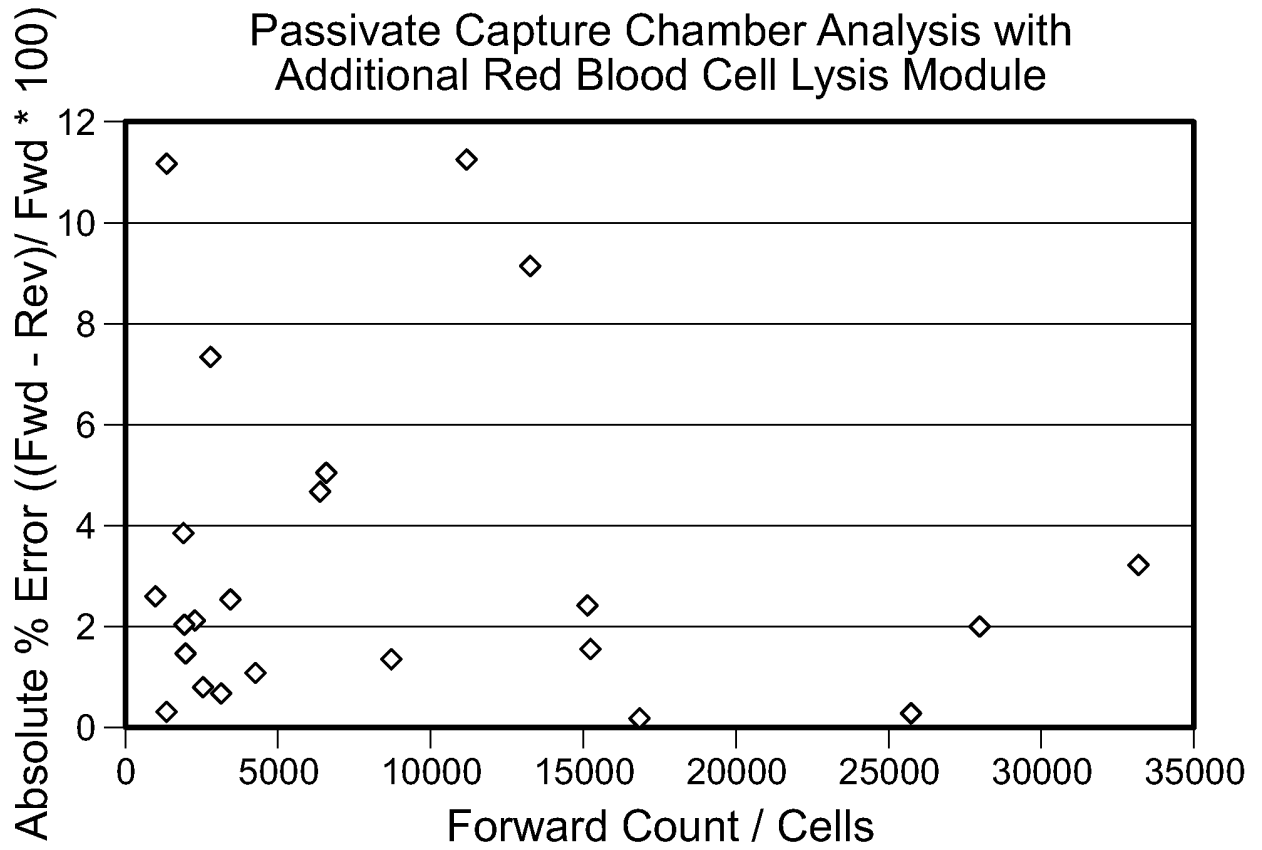

FIG. 26

REFERENCES CITED IN THE DESCRIPTION

This list of references cited by the applicant is for the reader's convenience only. It does not form part of the European patent document. Even though great care has been taken in compiling the references, errors or omissions cannot be excluded and the EPO disclaims all liability in this regard.

Patent documents cited in the description

- US 61411893 A [0001]
- US 5260192 A [0006]
- WO 2007106598 A [0007]
- US 20090298067 A1 [0049]
- US 5155044 A [0090]

Non-patent literature cited in the description

- **LEE et al.** A Flow Rate Independent Cell Concentration Measurement Chip Using Electrical Cell Counters Across a Fixed Control Volume. *JOURNAL OF MICROELECTROMECHANICAL SYSTEMS*, February 2008, vol. 17 (1) [0008]
- **CHENG et al.** Cell detection counting through cell lysate impedance spectroscopy in microfluidic devices. *Lab on a Chip*, 2007, vol. 7, 746-755 [0056]
- **USAMI et al.** Design and construction of a linear shear stress flow chamber. *Annals of Biomedical Engineering*, January 1993, vol. 21 (1), 77-83 [0056]
- **HINTERDORFER et al.** Detection and localization of individual antibody-antigen recognition events by atomic force microscopy. *Proceedings of the National Academy of Sciences of the United States of America*, 1996, vol. 93 (8), 3477-3481 [0056]
- **DAMMER et al.** Specific antigen/antibody interactions measured by force microscopy. *Biophysical Journal*, May 1996, vol. 70, 2437-2441 [0056]
- **HARADA et al.** Specific and quantized antigen-antibody interaction measured by atomic force microscopy. *Langmuir*, November 2000, vol. 16 (2), 708-715 [0056]
- **SETHU et al.** Continuous flow microfluidic device for rapid erythrocyte lysis. *Analytical Chemistry*, 2004, vol. 76, 6247-6253 [0062]
- **SETHU et al.** Microfluidic isolation of leukocytes from whole blood for phenotype and gene expression analysis. *Analytical Chemistry*, 2006, vol. 78, 5453-5461 [0062]
- **D. HOLMES ; D. PETTIGREW ; C. RECCIUS ; J. GWYER ; C. VAN BERKEL ; J. HOLLOWAY ; D. DAVIES ; H. MORGAN.** Leukocyte analysis and differentiation using high speed microfluidic single cell impedance cytometry. *Lab on a Chip*, 2009, vol. 9, 2881-2889 [0070]
- **HOLMES et al.** Leukocyte analysis and differentiation using high speed microfluidic single cell impedance cytometry. *Lab on a Chip*, 2009, vol. 9, 2881-2889 [0090]
- **CHREUNG et al.** Microfluidic Impedance-Based Flow Cytometry. *Cytometry*, 2010, vol. 77A, 648-666 [0090]
- **SWERYDA-KRAWIEC et al.** A new interpretation of serum albumin surface passivation. *Langmuir*, September 2004, vol. 20, 2054-2056 [0097]
- **CHENG et al.** Cell detection counting through cell lysate impedance spectroscopy in microfluidic devices. *Lab on a Chip*, 2007, vol. 7, 746-755 [0105]
- **FREEMAN et al.** Real time, high resolution studies of protein adsorption and structure at the solid-liquid interface using dual polarization interferometry. *Journal of Physics: Condensed Matter*, 2004, vol. 16, S2493-S2496 [0105]
- **DANIELS et al.** Functional histology: A text and colour Atlas. Churchill Livingstone, 1979 [0111]

专利名称(译)	使用电子差分计数器计数粒子		
公开(公告)号	EP2638393A4	公开(公告)日	2016-06-01
申请号	EP2011839117	申请日	2011-11-09
[标]申请(专利权)人(译)	通用医疗公司 麻省理工学院 达克雷诊断器材有限公司		
申请(专利权)人(译)	总医院CORPORATION 麻省理工学院 伊利诺伊大学的董事会 DAKTARI诊断, INC.		
当前申请(专利权)人(译)	总医院CORPORATION 麻省理工学院 伊利诺伊大学的董事会 DAKTARI诊断, INC.		
[标]发明人	WATKINS NICHOLAS BASHIR RASHID RODRIGUEZ WILLIAM CHENG XUANHONG TONER MEHMET CHEN GRACE OPPENHEIMER AARON		
发明人	WATKINS, NICHOLAS BASHIR, RASHID RODRIGUEZ, WILLIAM CHENG, XUANHONG TONER, MEHMET CHEN, GRACE OPPENHEIMER, AARON		
IPC分类号	G01N33/53 G01N33/52 G01N21/17 C12M1/34 G01N15/10 G01N15/12 G01N15/14 G01N33/543 G01N33/569		
CPC分类号	B01L2200/0652 B01L2300/0877 C12M41/36 G01N15/1245 G01N33/56972 G01N2015/1006 G01N2015/1486 G01N15/12 G01N27/02 G01N2015/1062		
优先权	61/411893 2010-11-09 US		
其他公开文献	EP2638393A2 EP2638393B1		
外部链接	Espacenet		

摘要(译)

本公开涉及计数感兴趣的颗粒(例如细胞)的方法和装置。该方法包括获得可能含有目标颗粒的流体样品;使用第一电差分计数器计数样品的一部分中的所有类型的颗粒以产生第一总量;从流体样品的一部分中除去任何感兴趣的颗粒;在去除感兴趣的颗粒以产生第二总量之后,使用第二电差分计数器计数保留在流体样品的该部分中的任何颗粒;并且通过从第一总数中减去第二总数来计算原始在流体样本中的多个感兴趣的粒子,其中该差异是样本中感兴趣的粒子的数量。例如,这些方法和相关装置可用于产生用于全血样品中CD4 + T细胞计数的稳健,廉价的诊断试剂盒。

