



(12) **EUROPEAN PATENT APPLICATION**

(43) Date of publication:
27.12.2006 Bulletin 2006/52

(51) Int Cl.:
G01N 27/00 (2006.01) C30B 29/60 (2006.01)
H01L 29/00 (2006.01) C30B 25/00 (2006.01)
C30B 23/00 (2006.01)

(21) Application number: **06121157.9**

(22) Date of filing: **11.12.2001**

(84) Designated Contracting States:
**AT BE CH CY DE DK ES FI FR GB GR IE IT LI LU
MC NL PT SE TR**
Designated Extension States:
AL BA HR MK YU

- **Park, Hongkun**
Massachusetts, MA 02420 (US)
- **Wei, Quinqiao**
Cambridge, MA 02138 (US)
- **Cui, Yi**
Allston, MA 02134 (US)
- **Liang, Wenjie**
Somerville, MA 02143 (US)

(30) Priority: **11.12.2000 US 254745 P**
16.05.2001 US 292035 P

(62) Document number(s) of the earlier application(s) in accordance with Art. 76 EPC:
01990181.8 / 1 342 075

(74) Representative: **Piotrowicz, Pawel Jan Andrzej et al**
Venner Shipley LLP
Byron House
Cambridge Business Park
Cowley Road
Cambridge CB4 0WZ (GB)

(71) Applicant: **PRESIDENT AND FELLOWS OF HARVARD COLLEGE**
Cambridge, MA 02138 (US)

(72) Inventors:
• **Lieber, Charles**
Massachusetts, MA 02173 (US)

Remarks:
This application was filed on 22 - 09 - 2006 as a divisional application to the application mentioned under INID code 62.

(54) **Nanosensors**

(57) Electrical devices comprised of nanowires are described, along with methods of their manufacture and

use. The nanowires can be nanotubes and nanowires. The surface of the nanowires may be selectively functionalized. Nanodetector devices are described.

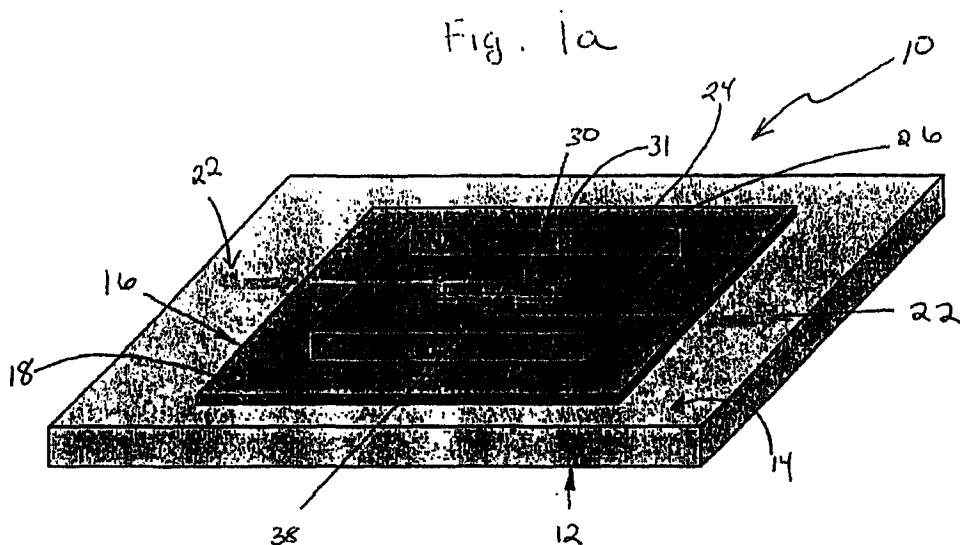

Description

NANOSENSORS

5 **[0001]** This invention was sponsored by the National Science Foundation Grant No. 981226 and the Office of Naval Research Contract No. N00014-00-0-0476. The government has certain rights in the invention.

Related Applications

10 **[0002]** This application claims priority under 35 U.S.C. §119(e) to commonly-owned, co-pending U.S. Provisional Patent Application Serial Nos. 60/292,035, entitled "Nanowire and Nanotube Nanosensors," filed May 18, 2001 and 60/254,745, entitled "Nanowire and Nanotube Nanosensors," filed December 11, 2000, each of which is hereby incorporated by reference in its entirety.

15 Field of Invention

[0003] The present invention relates generally to nanowires and nanoscale devices and more particularly to a nanoscale device having a nanowire or functionalized nanowires for detecting the presence or absence of an analyte suspected to be present in a sample, and method for using same.

20

Background of the Invention

[0004] Nanowires are ideally suited for efficient transport of charge carriers and excitons, and thus are expected to be critical building blocks for nanoscale electronics and optoelectronics. Studies of electrical transport in carbon nanotubes have led to the creation of field effect transistors, single electron transistors, and rectifying junctions.

25

Summary of the Invention

[0005] The present invention provides a series of nanoscale devices and methods of use of the same.

30

[0006] In one aspect, the invention provides a nanoscale device. The device is defined by a sample exposure region and a nanowire, wherein at least a portion of the nanowire is addressable by a sample in the sample exposure region. In one embodiment, the device may further comprise a detector able to determine a property associated with the nanowire.

[0007] In another embodiment, the device is a sample cassette comprising a sample exposure region and a nanowire. At least a portion of the nanowire is addressable by a sample in the sample exposure region, and the sample cassette is operatively connectable to a detector apparatus that is able to determine a property associated with the nanowire.

35

[0008] In another embodiment, the device is a sensor comprising at least one nanowire and means for measuring a change in a property of the at least one nanowire.

[0009] In another embodiment, the device comprises functionalized nanowires comprising a core region of a bulk nanowire and an outer region of functional moieties.

40

[0010] Another aspect of the invention provides a method involving determining a property change of a nanowire when the nanowire is contacted with a sample suspected of containing an analyte.

[0011] Another method involves measuring a change in a property associated with a nanowire, when the nanowire is contacted with a sample having a volume of less than about 10 microliters.

[0012] Another method involves determining the presence or quantity of an analyte in a sample suspected of containing an analyte. A change in a property of a nanowire resulting from contacting the nanowire and the sample is measured

45

[0013] Another method for detecting an analyte comprises contacting a nanowire with a sample and determining a property associated with the nanowire. A change in the property of the nanowire indicates the presence or quantity of the analyte in the sample.

[0014] Another method comprises contacting an electrical conductor with a sample and determining the presence or quantity of an analyte in the sample by measuring a change in a property of the conductor resultant from the contact. Less than ten molecules of the analyte contribute to the change in the property.

50

[0015] Another aspect of the invention provides an integrated multifunctionary system comprising a nanowire sensor, a signal interpreter, signal feedback component and an intervention delivery component.

[0016] Another aspect of the invention provides a nanowire sensor device comprising a semiconductor nanowire and a binding partner having a specificity for a selected moiety. The nanowire has an exterior surface formed thereon to form a gate electrode. The nanowire also has a first end in electrical contact with a conductor to form a source electrode and a second end in contact with a conductor to form a drain electrode.

55

[0017] Another aspect of the invention provides an analyte-gated field effect transistor having a predetermined current-

voltage characteristic and adapted for use as a chemical or biological sensor. The field effect transistor comprises a substrate formed of a first insulating material, a source electrode, a drain electrode, and a semiconductor nanowire disposed between the source and drain electrodes, and an analyte-specific binding partner disposed on a surface of the nanowire. A binding event occurring between a target analyte and the binding partner causes a detectable change in a current-voltage characteristic of the field effect transistor. Another aspect of the invention provides an array of at least 100 analyte gate field effect transistors.

[0018] Other advantages, novel features, and objects of the invention will become apparent from the following detailed description of non-limiting embodiments of the invention when considered in conjunction with the accompanying drawings, which are schematic and which are not intended to be drawn to scale. In the figures, each identical or nearly identical component that is illustrated in various figures is represented by a single numeral. For purposes of clarity, not every component is labeled in every figure, nor is every component of each embodiment of the invention shown where illustration is not necessary to allow those of ordinary skill in the art to understand the invention.

Brief Description of the Drawings

[0019]

Fig. 1a illustrates, schematically, a nanoscale detector device.

Fig. 1b illustrates, schematically, a nanoscale detector device with a parallel array of nanowires.

Fig. 2a illustrates, schematically, a nanoscale detector device in which a nanowire has been modified with a binding agent for detection of a complementary binding partner.

Fig. 2b illustrates, schematically, the nanoscale detector device of Fig. 2a, in which a complementary binding partner is fastened to the binding agent.

Fig. 3a is a low resolution scanning electron micrograph of a single silicon nanowire connected to two metal electrodes.

Fig. 3b is a high resolution scanning electron micrograph of a single silicon nanowire device connected to two metal electrodes.

Fig. 4a shows schematically another embodiment of a nanoscale sensor having a backgate.

Figs. 4b shows conductance vs. time with various backgate voltages.

Fig. 4c shows conductance vs. backgate voltage.

Fig. 5a shows conductance for a single silicon nanowire as a function of pH.

Fig. 5b shows conductance versus pH for a single silicon nanowire that has been modified to expose amine groups at the surface.

Fig. 6 shows conductance versus time for a silicon nanowire with a surface modified with oligonucleotide agents.

Fig. 7 is an atomic force microscopy image of a typical single wall nanotube detector device.

Fig. 8a shows current-voltage (I-V) measurements for a single-walled carbon nanotube device in air.

Fig. 8b shows current-voltage (I-V) measurements for the single-walled carbon nanotube device of Fig. 8a in NaCl.

Fig. 8c shows current-voltage (I-V) measurements for a single-walled carbon nanotube device of Fig. 8b in CrCl₃.

Fig. 9a shows the conductance of nanosensors with hydroxyl surface groups when exposed to pH levels from 2 to 9.

Fig. 9b shows the conductance of nanosensors modified with amine groups when exposed to pH levels from 2 to 9.

Fig. 9c show the relative conductance of the nanosensors with changes in pH levels.

Fig. 10a shows the conductance of a SiNW modified with BSA Biotin, as it is exposed first to a blank buffer solution, and then to a solution containing 250 nM Streptavidin.

Fig. 10b shows the conductance of a SiNW modified with BSA Biotin, as it is exposed first to a blank buffer solution, and then to a solution containing 25 pM Streptavidin.

Fig. 10c shows the conductance of a bare SiNW as it is exposed first to a blank buffer solution, and then to a solution containing Streptavidin.

Fig. 10d shows the conductance of a SiNW modified with BSA Biotin, as it is exposed to a buffer solution, and then to a solution containing d-biotin Streptavidin.

Fig. 10e shows the conductance of a Biotin modified nanosensor exposed to a blank buffer solution, then to a solution containing Streptavidin, and then again to a blank buffer solution.

Fig. 10f shows the conductance of a bare SiNW as it is alternately exposed to a buffer solution and a solution containing streptavidin.

Fig. 11a shows the conductance of a BSA-Biotin modified SiNW as it is exposed first to a blank buffer solution, then to a solution containing Antibiotin.

Fig. 11b shows the conductance of a bare SiNW during contact with a buffer solution and then a solution containing Antibiotin.

Fig. 11c shows the conductance of a BSA-Biotin modified SiNW during exposure to a buffer, other IgG type antibodies,

and then Antibiotin.

Fig. 12a shows the conductance of an amine modified SiNW when alternately exposed to a blank buffer solution and a solution containing 1mM Cu(II).

Fig. 12b shows the conductance of the amine modified SiNW is exposed to concentrations of Cu(II) from 0.1 mM to 1mM.

Fig. 12c shows the conductance verses Cu(II) concentration.

Fig. 12d shows conductance of an unmodified SiNW when exposed first to a blank buffer solution and then to 1mM Cu(II).

Fig. 12e shows conductance of an amine-modified SiNW when exposed first to a blank buffer solution and then to 1mM Cu(II)-EDTA.

Fig. 13a shows the conductance of a calmodulin-modified silicon nanowire exposed to a buffer solution and then to a solution containing calcium ions.

Fig. 13b shows the conductance of a bare silicon nanowire exposed to a buffer solution and then to a solution containing calcium ions.

Fig. 14a shows a calculation of sensitivity for detecting up to 5 charges compared with doping concentration and nanowire diameter.

Fig. 14b shows a calculation of the threshold doping density compared to nanowire diameter for detecting a single charge.

Fig. 15 is a schematic view of an InP nanowire.

Fig. 15b shows the change in luminescence of a nanowire of Fig. 15a over time as pH varies.

Fig. 16a depicts one embodiment of a nanowire sensor, specifically a chemical or ligand-gated Field Effects Transistor (FET).

Fig. 16b show another view of the nanowire of Fig. 16a.

Fig. 16c illustrates the nanowire of Fig. 16a with moieties at the surface.

Fig. 16d illustrates the nanowire of Fig. 16c with a depletion region.

Detailed Description of the Invention

[0020] The present invention provides a series of techniques and devices involving nanowires. One aspect of the invention provides functionalized nanowires. While many uses for nanowires have been developed, many more different and important uses are facilitated by the present invention where the nanowires are functionalized at their surface, or in close proximity to their surface. In one particular case, functionalization (e.g., with a reaction entity), either uniformly or non-uniformly, permits interaction of the functionalized nanowire with various entities, such as molecular entities, and the interaction induces a change in a property of the functionalized nanowire, which provides a mechanism for a nanoscale sensing device. Another aspect of the invention is a sensor that comprises a nanowire, or a functionalized nanowire. Various aspects of the invention are described below in greater detail.

[0021] As used herein, a "nanowire" is an elongated nanoscale semiconductor which, at any point along its length, has at least one cross-sectional dimension and, in some embodiments, two orthogonal cross-sectional dimensions less than 500 nanometers, preferably less than 200 nanometers, more preferably less than 150 nanometers, still more preferably less than 100 nanometers, even more preferably less than 70, still more preferably less than 50 nanometers, even more preferably less than 20 nanometers, still more preferably less than 10 nanometers, and even less than 5 nanometers. In other embodiments, the cross-sectional dimension can be less than 2 nanometers or 1 nanometer. In one set of embodiments the nanowire has at least one cross-sectional dimension ranging from 0.5 nanometers to 200 nanometers. Where nanowires are described having a core and an outer region, the above dimensions relate to those of the core. The cross-section of the elongated semiconductor may have any arbitrary shape, including, but not limited to, circular, square, rectangular, elliptical and tubular. Regular and irregular shapes are included. A non-limiting list of examples of materials from which nanowires of the invention can be made appears below. Nanotubes are a class of nanowires that find use in the invention and, in one embodiment, devices of the invention include wires of scale commensurate with nanotubes. As used herein, a "nanotube" is a nanowire that has a hollowed-out core, and includes those nanotubes known to those of ordinary skill in the art. A "non-nanotube nanowire" is any nanowire that is not a nanotube. In one set of embodiments of the invention, a non-nanotube nanowire having an unmodified surface (not including an auxiliary reaction entity not inherent in the nanotube in the environment in which it is positioned) is used in any arrangement of the invention described herein in which a nanowire or nanotube can be used. A "wire" refers to any material having a conductivity at least that of a semiconductor or metal. For example, the term "electrically conductive" or a "conductor" or an "electrical conductor" when used with reference to a "conducting" wire or a nanowire refers to the ability of that wire to pass charge through itself. Preferred electrically conductive materials have a resistivity lower than about 10^{-3} , more preferably lower than about 10^{-4} , and most preferably lower than about 10^{-6} or 10^{-7} ohm-meters.

[0022] The invention provides a nanowire or nanowires preferably forming part of a system constructed and arranged

to determine an analyte in a sample to which the nanowire(s) is exposed. "Determine", in this context, means to determine the quantity and/or presence of the analyte in the sample. Presence of the analyte can be determined by determining a change in a characteristic in the nanowire, typically an electrical characteristic or an optical characteristic. E.g. an analyte causes a detectable change in electrical conductivity of the nanowire or optical properties. In one embodiment, the nanowire includes, inherently, the ability to determine the analyte. The nanowire may be functionalized, i.e. comprising surface functional moieties, to which the analytes binds and induces a measurable property change to the nanowire. The binding events can be specific or non-specific. The functional moieties may include simple groups, selected from the groups including, but not limited to, —OH, —CHO, —COOH, —SO₃H, —CN, —NH₂, —SH, —COSH, COOR, halide; biomolecular entities including, but not limited to, amino acids, proteins, sugars, DNA, antibodies, antigens, and enzymes; grafted polymer chains with chain length less than the diameter of the nanowire core, selected from a group of polymers including, but not limited to, polyamide, polyester, polyimide, polyacrylic; a thin coating covering the surface of the nanowire core, including, but not limited to, the following groups of materials: metals, semiconductors, and insulators, which may be a metallic element, an oxide, an sulfide, a nitride, a selenide, a polymer and a polymer gel. In another embodiment, the invention provides a nanowire and a reaction entity with which the analyte interacts, positioned in relation to the nanowire such that the analyte can be determined by determining a change in a characteristic of the nanowire.

[0023] The term "reaction entity" refers to any entity that can interact with an analyte in such a manner to cause a detectable change in a property of a nanowire. The reaction entity may enhance the interaction between the nanowire and the analyte, or generate a new chemical species that has a higher affinity to the nanowire, or to enrich the analyte around the nanowire. The reaction entity can comprise a binding partner to which the analyte binds. The reaction entity, when a binding partner, can comprise a specific binding partner of the analyte. For example, the reaction entity may be a nucleic acid, an antibody, a sugar, a carbohydrate or a protein. Alternatively, the reaction entity may be a polymer, catalyst, or a quantum dot. A reaction entity that is a catalyst can catalyze a reaction involving the analyte, resulting in a product that causes a detectable change in the nanowire, e.g. via binding to an auxiliary binding partner of the product electrically coupled to the nanowire. Another exemplary reaction entity is a reactant that reacts with the analyte, producing a product that can cause a detectable change in the nanowire. The reaction entity can comprise a coating on the nanowire, e.g. a coating of a polymer that recognizes molecules in, e.g., a gaseous sample, causing a change in conductivity of the polymer which, in turn, causes a detectable change in the nanowire.

[0024] The term "quantum dot" is known to those of ordinary skill in the art, and generally refers to semiconductor or metal nanoparticles that absorb light and quickly re-emit light in a different color depending on the size of the dot. For example, a 2 nanometer quantum dot emits green light, while a 5 nanometer quantum dot emits red light. Cadmium Selenide quantum dot nanocrystals are available from Quantum Dot Corporation of Hayward, California.

[0025] The term "binding partner" refers to a molecule that can undergo binding with a particular analyte, or "binding partner" thereof, and includes specific, semi-specific, and non-specific binding partners as known to those of ordinary skill in the art. E.g., Protein A is usually regarded as a "non-specific" or semi-specific binder. The term "specifically binds", when referring to a binding partner (e.g., protein, nucleic acid, antibody, etc.), refers to a reaction that is determinative of the presence and/or identity of one or other member of the binding pair in a mixture of heterogeneous molecules (e.g., proteins and other biologics). Thus, for example, in the case of a receptor/ligand binding pair the ligand would specifically and/or preferentially select its receptor from a complex mixture of molecules, or vice versa. An enzyme would specifically bind to its substrate, a nucleic acid would specifically bind to its complement, an antibody would specifically bind to its antigen. Other examples include, nucleic acids that specifically bind (hybridize) to their complement, antibodies specifically bind to their antigen, and the like.

[0026] The binding may be by one or more of a variety of mechanisms including, but not limited to ionic interactions, and/or covalent interactions, and/or hydrophobic interactions, and/or van der Waals interactions, etc.

[0027] The term "fluid" is defined as a substance that tends to flow and to conform to the outline of its container: Typically fluids are materials that are unable to withstand a static shear stress. When a shear stress is applied to a fluid it experiences a continuing and permanent distortion. Typical fluids include liquids and gasses, but may also include free flowing solid particles.

[0028] The term "sample" refers to any cell, tissue, or fluid from a biological source (a "biological sample"), or any other medium, biological or non-biological, that can be evaluated in accordance with the invention including, such as serum or water. A sample includes, but is not limited to, a biological sample drawn from an organism (e.g. a human, a non-human mammal, an invertebrate, a plant, a fungus, an algae, a bacteria, a virus, etc.), a sample drawn from food designed for human consumption, a sample including food designed for animal consumption such as livestock feed, milk, an organ donation sample, a sample of blood destined for a blood supply, a sample from a water supply, or the like. One example of a sample is a sample drawn from a human or animal to determine the presence or absence of a specific nucleic acid sequence.

[0029] A "sample suspected of containing" a particular component means a sample with respect to which the content of the component is unknown. For example, a fluid sample from a human suspected of having a disease, such as a

neurodegenerative disease or a non-neurodegenerative disease, but not known to have the disease, defines a sample suspected of containing neurodegenerative disease. "Sample" in this context includes naturally-occurring samples, such as physiological samples from humans or other animals, samples from food, livestock feed, etc. Typical samples taken from humans or other animals include tissue biopsies, cells, whole blood, serum or other blood fractions, urine, ocular fluid, saliva, cerebro-spinal fluid, fluid or other samples from tonsils, lymph nodes, needle biopsies, etc.

[0030] The term "electrically coupled" when used with reference to a nanowire and an analyte, or other moiety such as a reaction entity, refers to an association between any of the analyte, other moiety, and the nanowire such that electrons can move from one to the other, or in which a change in an electrical characteristic of one can be determined by the other. This can include electron flow between these entities, or a change in a state of charge, oxidation, or the like that can be determined by the nanowire. As examples, electrical coupling can include direct covalent linkage between the analyte or other moiety and the nanowire, indirect covalent coupling (*e.g.* via a linker), direct or indirect ionic bonding between the analyte (or other moiety) and the nanowire, or other bonding (*e.g.* hydrophobic bonding). In some cases, no actual bonding may be required and the analyte or other moiety may simply be contacted with the nanowire surface. There also need not necessarily be any contact between the nanowire and the analyte or other moiety where the nanowire is sufficiently close to the analyte to permit electron tunneling between the analyte and the nanowire.

[0031] The terms "polypeptide", "peptide" and "protein" are used interchangeably herein to refer to a polymer of amino acid residues. The terms apply to amino acid polymers in which one or more amino acid residue is an artificial chemical analogue of a corresponding naturally occurring amino acid, as well as to naturally occurring amino acid polymers. The term also includes variants on the traditional peptide linkage joining the amino acids making up the polypeptide.

[0032] The terms "nucleic acid" or "oligonucleotide" or grammatical equivalents herein refer to at least two nucleotides covalently linked together. A nucleic acid of the present invention is preferably single-stranded or double stranded and will generally contain phosphodiester bonds, although in some cases, as outlined below, nucleic acid analogs are included that may have alternate backbones, comprising, for example, phosphoramidate (Beaucage et al. (1993) *Tetrahedron* 49 (10):1925) and references therein; Letsinger (1970) *J. Org. Chem.* 35:3800; Sprinzl et al. (1977) *Eur. J. Biochem.* 81: 579; Letsinger et al. (1986) *Nucl. Acids Res.* 14: 3487; Sawai et al. (1984) *Chem. Lett.* 805, Letsinger et al. (1988) *J. Am. Chem. Soc.* 110: 4470; and Pauwels et al. (1986) *Chemica Scripta* 26: 1419), phosphorothioate (Mag et al. (1991) *Nucleic Acids Res.* 19:1437; and U.S. Patent No. 5,644,048), phosphorodithioate (Briu et al. (1989) *J. Am. Chem. Soc.* 111 :2321, O-methylphosphoroamidite linkages (*see* Eckstein, *Oligonucleotides and Analogues: A Practical Approach*, Oxford University Press), and peptide nucleic acid backbones and linkages (*see* Egholm (1992) *J. Am. Chem. Soc.* 114: 1895; Meier et al. (1992) *Chem. Int. Ed. Engl.* 31: 1008; Nielsen (1993) *Nature*, 365: 566; Carlsson et al. (1996) *Nature* 380: 207). Other analog nucleic acids include those with positive backbones (Denpcy et al. (1995) *Proc. Natl. Acad. Sci. USA* 92: 6097; non-ionic backbones (U.S. Patent Nos. 5,386,023, 5,637,684, 5,602,240, 5,216,141 and 4,469,863; *Angew.* (1991) *Chem. Intl. Ed. English* 30: 423; Letsinger et al. (1988) *J. Am. Chem. Soc.* 110:4470; Letsinger et al. (1994) *Nucleoside & Nucleotide* 13:1597; Chapters 2 and 3, ASC Symposium Series 580, "Carbohydrate Modifications in Antisense Research", Ed. Y.S. Sanghui and P. Dan Cook; Mesmaeker et al. (1994), *Bioorganic & Medicinal Chem. Lett.* 4: 395; Jeffs et al. (1994) *J. Biomolecular NMR* 34:17; *Tetrahedron Lett.* 37:743 (1996)) and non-ribose backbones, including those described in U.S. Patent Nos. 5,235,033 and 5,034,506, and Chapters 6 and 7, ASC Symposium Series 580, *Carbohydrate Modifications in Antisense Research*, Ed. Y.S. Sanghui and P. Dan Cook. Nucleic acids containing one or more carbocyclic sugars are also included within the definition of nucleic acids (*see* Jenkins et al. (1995), *Chem. Soc. Rev.* pp. 169-176). Several nucleic acid analogs are described in Rawls, C & E News June 2, 1997 page 35. These modifications of the ribose-phosphate backbone may be done to facilitate the addition of additional moieties such as labels, or to increase the stability and half-life of such molecules in physiological environments.

[0033] As used herein, an "antibody" refers to a protein or glycoprotein consisting of one or more polypeptides substantially encoded by immunoglobulin genes or fragments of immunoglobulin genes. The recognized immunoglobulin genes include the kappa, lambda, alpha, gamma, delta, epsilon and mu constant region genes, as well as myriad immunoglobulin variable region genes. Light chains are classified as either kappa or lambda. Heavy chains are classified as gamma, mu, alpha, delta, or epsilon, which in turn define the immunoglobulin classes, IgG, IgM, IgA, IgD and IgE, respectively. A typical immunoglobulin (antibody) structural unit is known to comprise a tetramer. Each tetramer is composed of two identical pairs of polypeptide chains, each pair having one "light" (about 25 kD) and one "heavy" chain (about 50-70 kD). The N-terminus of each chain defines a variable region of about 100 to 110 or more amino acids primarily responsible for antigen recognition. The terms variable light chain (VL) and variable heavy chain (VH) refer to these light and heavy chains respectively.

[0034] Antibodies exist as intact immunoglobulins or as a number of well characterized fragments produced by digestion with various peptidases. Thus, for example, pepsin digests an antibody below (*i.e.* toward the Fc domain) the disulfide linkages in the hinge region to produce F(ab)², a dimer of Fab which itself is a light chain joined to V_H-C_H1 by a disulfide bond. The F(ab)² may be reduced under mild conditions to break the disulfide linkage in the hinge region thereby converting the (Fab)² dimer into an Fab' monomer. The Fab' monomer is essentially a Fab with part of the hinge region (*see*, Paul (1993) *Fundamental Immunology*, Raven Press, N.Y. for a more detailed description of other antibody frag-

ments). While various antibody fragments are defined in terms of the digestion of an intact antibody, one of skill will appreciate that such fragments may be synthesized de novo either chemically, by utilizing recombinant DNA methodology, or by "phage display" methods (see, e.g., Vaughan et al. (1996) *Nature Biotechnology*, 14(3): 309-314, and PCT/US96/10287). Preferred antibodies include single chain antibodies, e.g., single chain Fv (scFv) antibodies in which a variable heavy and a variable light chain are joined together (directly or through a peptide linker) to form a continuous polypeptide.

[0035] One aspect of the invention involves a sensing element, which can be an electronic sensing element, and a nanowire able to detect the presence, or absence, of an analyte in a sample (e.g. a fluid sample) containing, or suspected of containing, the analyte. Nanoscale sensors of the invention may be used, for example, in chemical applications to detect pH or the presence of metal ions; in biological applications to detect a protein, nucleic acid (e.g. DNA, RNA, etc.), a sugar or carbohydrate, and /or metal ions; and in environmental applications to detect pH, metal ions, or other analytes of interest.

[0036] Another aspect of the present invention provides an article comprising a nanowire and a detector constructed and arranged to determine a change in an electrical property of the nanowire. At least a portion of the nanowire is addressable by a sample containing, or suspected of containing, an analyte. The phrase "addressable by a fluid" is defined as the ability of the fluid to be positioned relative to the nanowire so that an analyte suspected of being in the fluid is able to interact with the nanowire. The fluid may be proximate to or in contact with the nanowire.

[0037] In all of the illustrative embodiments described herein, any nanowire can be used, including carbon nanotubes, nanorods, nanowires, organic and inorganic conductive and semiconducting polymers, and the like unless otherwise specified. Other conductive or semiconducting elements that may not be molecular wires, but are of various small nanoscopic-scale dimension, also can be used in some instances, e.g. inorganic structures such as main group and metal atom-based wire-like silicon, transition metal-containing wires, gallium arsenide, gallium nitride, indium phosphide, germanium, cadmium selenide structures. A wide variety of these and other nanowires can be grown on and/or applied to surfaces in patterns useful for electronic devices in a manner similar to techniques described herein involving nanowires, without undue experimentation. The nanowires should be able to be formed of at least one micron, preferably at least three microns, more preferably at least five microns, and more preferably still at least ten or twenty microns in length, and preferably are less than about 100 nanometers, more preferably less than about 75 nanometers, and more preferably less than about 50 nanometers, and more preferably still less than about 25 nanometers in thickness (height and width). The wires should have an aspect ratio (length to thickness) of at least about 2:1, preferably greater than about 10:1, and more preferably greater than about 1000:1. A preferred nanowire for use in devices of the invention can be either a nanotube or a nanowire. Nanotubes (e.g. carbon nanotubes) are hollow. Nanowires (e.g. silicon nanowires) are solid.

[0038] Whether nanotubes or nanowires are selected, the criteria for selection of nanowires and other conductors or semiconductors for use in the invention are based, in some instances, mainly upon whether the nanowire itself is able to interact with an analyte, or whether the appropriate reaction entity, e.g. binding partner, can be easily attached to the surface of the nanowire, or the appropriate reaction entity, e.g. binding partner, is near the surface of the nanowire. Selection of suitable conductors or semiconductors, including nanowires, will be apparent and readily reproducible by those of ordinary skill in the art with the benefit of the present disclosure.

[0039] Nanotubes that may be used in the present invention include single-walled nanotubes (SWNTs) that exhibit unique electronic, and chemical properties that are particularly suitable for molecular electronics. Structurally, SWNTs are formed of a single graphene sheet rolled into a seamless tube with a diameter on the order of about 0.5 nm to about 5 nm and a length that can exceed about 10 microns. Depending on diameter and helicity, SWNTs can behave as one-dimensional metals or semiconductor and are currently available as a mixture of metallic and semiconducting nanotubes. Methods of manufacture of nanotubes, including SWNTs, and characterization are known. Methods of selective functionalization on the ends and/or sides of nanotubes also are known, and the present invention makes use of these capabilities for molecular electronics. The basic structural/electronic properties of nanotubes can be used to create connections or input/output signals, and nanotubes have a size consistent with molecular scale architecture.

[0040] Preferred nanowires of the present invention are individual nanowires. As used herein, "individual nanowires" means a nanowire free of contact with another nanowire (but not excluding contact of a type that may be desired between individual nanowires in a crossbar array). For example, typical individual nanowire can have a thickness as small as about 0.5 nm. This is in contrast to nanowires produced primarily by laser vaporization techniques that produce high-quality materials, but materials formed as ropes having diameters of about 2 to about 50 nanometers or more and containing many individual nanowires (see, for example, Thess, et al., "Crystalline Ropes of Metallic Carbon Nanotubes" *Science* 273, 483-486 (1996), incorporated herein by reference). While nanowire ropes can be used in the invention, individual nanowires are preferred.

[0041] The invention may utilize metal-catalyzed CVD to synthesize high quality individual nanowires such as nanotubes for molecular electronics. CVD synthetic procedures needed to prepare individual wires directly on surfaces and in bulk form are known, and can readily be carried out by those of ordinary skill in the art. See, for example, Kong, et al., "Synthesis of Individual Single-Walled Carbon Nanotubes on Patterned Silicon Wafers", *Nature* 395, 878-881 (1998)

; Kong, et al., "Chemical Vapor Deposition of Methane for Single-Walled Carbon Nanotubes" Chem. Phys. Lett. 292, 567-574 (1998), both incorporated herein by reference. Nanowires may also be grown through laser catalytic growth. See, for example, Morales et al. "A Laser Ablation Method for the Synthesis of Crystalline Semiconductor Nanowires" Science 279, 208-211 (1998), incorporated herein by reference.

5 **[0042]** Alternatively, the nanowire may comprise a semiconductor that is doped with an appropriate dopant to create an n-type or p-type semiconductor as desired. For example, silicon may be doped with boron, aluminum, phosphorous, or arsenic. Laser catalytic growth may be used to introduce controllably the dopants during the vapor phase growth of silicon nanowires.

10 **[0043]** Controlled doping of nanowires can be carried out to form, e.g., n-type or p-type semiconductors. In various embodiments, this invention involves controlled doping of semiconductors selected from among indium phosphide, gallium arsenide, gallium nitride, cadmium selenide, and zinc selenide. Dopants including, but not limited to, zinc, cadmium, or magnesium can be used to form p-type semiconductors in this set of embodiments, and dopants including, but not limited to, tellurium, sulfur, selenium, or germanium can be used as dopants to form n-type semiconductors from these materials. These materials define direct band gap semiconductor materials and these and doped silicon are well known to those of ordinary skill in the art. The present invention contemplates use of any doped silicon or direct band gap semiconductor materials for a variety of uses.

15 **[0044]** As examples of nanowire growth, placement, and doping, SiNWs (elongated nanoscale semiconductors) may be synthesized using laser assisted catalytic growth (LCG). As shown in Figs. 2 and 3, laser vaporization of a composite target that is composed of a desired material (e.g. InP) and a catalytic material (e.g. Au) creates a hot, dense vapor which quickly condenses into liquid nanoclusters through collision with the buffer gas. Growth begins when the liquid nanoclusters become supersaturated with the desired phase and continues as long as the reactant is available. Growth terminates when the nanowires pass out of the hot reaction zone or when the temperature is turned down. Au is generally used as catalyst for growing a wide range of elongated nanoscale semiconductors. However, The catalyst is not limited to Au only. A wide range of materials such as (Ag, Cu, Zn, Cd, Fe, Ni, Co...) can be used as the catalyst. Generally, any metal that can form an alloy with the desired semiconductor material, but doesn't form more stable compound than with the elements of the desired semiconductor can be used as the catalyst. The buffer gas can be Ar, N₂, and others inert gases. Sometimes, a mixture of H₂ and buffer gas is used to avoid undesired oxidation by residue oxygen. Reactive gas can also be introduced when desired (e.g. ammonia for GaN). The key point of this process is laser ablation generates liquid nanoclusters that subsequently define the size and direct the growth direction of the crystalline nanowires. The diameters of the resulting nanowires are determined by the size of the catalyst cluster, which in turn can be varied by controlling the growth conditions (e.g. background pressure, temperature, flow rate...). For example, lower pressure generally produces nanowires with smaller diameters. Further diameter control can be done by using uniform diameter catalytic clusters.

20 **[0045]** With same basic principle as LCG, if uniform diameter nanoclusters (less than 10-20% variation depending on how uniform the nanoclusters are) are used as the catalytic cluster, nanowires with uniform size (diameter) distribution can be produced, where the diameter of the nanowires is determined by the size of the catalytic clusters, as illustrated in Fig. 4. By controlling the growth time, nanowires with different lengths can be grown.

25 **[0046]** With LCG, nanowires can be flexibly doped by introducing one or more dopants into the composite target (e.g., Ge for n-type doping of InP). The doping concentration can be controlled by controlling the relative amount of doping element, typically 0-20%, introduced in the composite target.

30 **[0047]** Laser ablation may be used as the way to generate the catalytic clusters and vapor phase reactant for growth of nanowires and other related elongated nanoscale structures, but fabrication is not limited to laser ablation. Many ways can be used to generate vapor phase and catalytic clusters for nanowire growth (e.g. thermal evaporation).

35 **[0048]** Another technique that may be used to grow nanowires is catalytic chemical vapor deposition (C-CVD). C-CVD utilizes the same basic principles as LCG, except that in the C-CVD method, the reactant molecules (e.g., silane and the dopant) are from vapor phase molecules (as opposed to vapor source from laser vaporization).

40 **[0049]** In C-CVD, nanowires can be doped by introducing the doping element into the vapor phase reactant (e.g. diborane and phosphane for p-type and n-type doped nanowire). The doping concentration can be controlled by controlling the relative amount of the doping element introduced in the composite target. It is not necessary to obtain elongated nanoscale semiconductors with the same doping ratio as that in the gas reactant. However, by controlling the growth conditions (e.g. temperature, pressure...), nanowires with same doping concentration can be reproduced. And the doping concentration can be varied over a large range by simply varying the ratio of gas reactant (e.g. 1ppm-10%).

45 **[0050]** There are several other techniques that may be used to grow elongated nanoscale semiconductors such as nanowires. For example, nanowires of any of a variety of materials can be grown directly from vapor phase through a vapor-solid process. Also, nanowires can also be produced by deposition on the edge of surface steps, or other types of patterned surfaces, as shown in Fig. 5. Further, nanowires can be grown by vapor deposition in/on any general elongated template, for example, as shown in Fig. 6. The porous membrane can be porous silicon, anodic alumina or diblock copolymer and any other similar structure. The natural fiber can be DNA molecules, protein molecules carbon

EP 1 736 760 A2

nanotubes, any other elongated structures. For all the above described techniques, the source materials can be come from a solution phase rather than a vapor phase. While in solution phase, the template can also be column micelles formed by surfactant molecules in addition to the templates described above.

[0051] Using one or more of the above techniques, elongated nanoscale semiconductors, including semiconductor nanowires and doped semiconductor nanowires, can be grown. Such bulk-doped semiconductors may include various combinations of materials, including semiconductors and dopants. The following are non-comprehensive lists of such materials. Other materials may be used. Such materials include, but are not limited to:

Elemental semiconductors:

[0052] Si, Ge, Sn, Se, Te, B, Diamond, P

Solid solution of Elemental semiconductors:

[0053] B-C, B-P(BP6), B-Si, Si-C, Si-Ge, Si-Sn, Ge-Sn

IV-IV group semiconductors:

[0054] SiC

III-V semiconductors:

[0055] BN/BP/BAs, AlN/AIP/AIAs/AISb, GaN/GaP/GaAs/GaSb, InN/InP/InAs/InSb,

Alloys of III-V Group:

[0056] any combination of two or more of the above compound (e.g.: AlGaN, GaPAs, InPAs, GaInN, AlGaInN, Galn-AsP...)

II-VI semiconductors:

[0057] ZnO/ZnS/ZnSe/ZnTe, CdS/CdSe/CdTe, HgS/HgSe/HgTe, BeS/BeSe/BeTe/MgS/MgSe

Alloys of II-VI Group: any combination of two or more of the above compound (e.g.: (ZnCd)Se, Zn(SSe)...)

Alloy of II-VI and III-V semiconductors:

[0058] combination of any one II-VI and one III-V compounds, e.g. (GaAs)_x(ZnS)_{1-x}

IV- VI semiconductors:

[0059] GeS, GeSe, GeTe, SnS, SnSe, SnTe, PbO, PbS, PbSe, PbTe

I-VII semiconductors:

[0060] CuF, CuCl, CuBr, CuI, AgF, AgCl, AgBr, AgI

Other semiconductor compounds:

[0061] II-IV-V₂: BeSiN₂, CaCN₂, ZnGeP₂, CdSnAs₂, ZnSnSb₂ ...

[0062] I-IV₂-V₃: CuGeP₃, CuSi₂P₃..

[0063] I-III-VI₂: Cu, Ag)(Al, Ga, In, Tl, Fe)(S, Se, Te)₂

[0064] IV₃-V₄: Si₃N₄, Ge₃N₄ ...

[0065] III₂-VI₃: Al₂O₃, (Al, Ga, In)₂(S, Se, Te)₃...

[0066] III₂-IV-VI: Al₂CO ...

[0067] For Group IV semiconductor materials, a p-type dopant may be selected from Group III, and an n-type dopant may be selected from Group V. For silicon semiconductor materials, a p-type dopant may be selected from the group consisting of B, Al and In, and an n-type dopant may be selected from the group consisting of P, As and Sb. For Group

III-V semiconductor materials, a p-type dopant may be selected from Group II, including Mg, Zn, Cd and Hg, or Group IV, including C and Si. An n-type dopant may be selected from the group consisting of Si, Ge, Sn, S, Se and Te. It will be understood that the invention is not limited to these dopants.

5 [0068] Nanowires may be either grown in place or deposited after growth. Assembly, or controlled placement of nanowires on surfaces after growth can be carried out by aligning nanowires using an electrical field. An electrical field is generated between electrodes, nanowires are positioned between the electrodes (optionally flowed into a region between the electrodes in a suspending fluid), and will align in the electrical field and thereby can be made to span the distance between and contact each of the electrodes.

10 [0069] In another arrangement individual contact points are arranged in opposing relation to each other, the individual contact points being tapered to form a point directed towards each other. An electric field generated between such points will attract a single nanowire spanning the distance between, and contacting each of, the electrodes. In this way individual nanowires can readily be assembled between individual pairs of electrical contacts. Crossed-wire arrangements, including multiple crossings (multiple parallel wires in a first direction crossed by multiple parallel wires in a perpendicular or approximately perpendicular second direction) can readily be formed by first positioning contact points (electrodes) at locations where opposite ends of the crossed wires desirably will lie. Electrodes, or contact points, can be fabricated via typical microfabrication techniques.

15 [0070] These assembly techniques can be substituted by, or complemented with, a positioning arrangement involving positioning a fluid flow directing apparatus to direct fluid containing suspended nanowires toward and in the direction of alignment with locations at which nanowires are desirably positioned.

20 [0071] Another arrangement involves forming surfaces including regions that selectively attract nanowires surrounded by regions that do not selectively attract them. For example, $-NH_2$ can be presented in a particular pattern at a surface, and that pattern will attract nanowires or nanotubes having surface functionality attractive to amines. Surfaces can be patterned using known techniques such as electron-beam patterning, "soft-lithography" such as that described in International Patent Publication No. WO 96/29629, published July 26, 1996, or U.S. Patent No. 5, 512,131, issued April 30, 1996, each of which is incorporated herein by reference.

25 [0072] A technique is also known to direct the assembly of a pre-formed nanowire onto a chemically patterned self-assembled monolayer. In one example of patterning the SAM for directed assembly of nanoscale circuitry atomic force microscopy (AFM) is used to write, at high resolution, a pattern in SAM at which the SAM is removed. The pattern can be for example linear for parallel arrays, or a crossed array of lines linear in embodiments for making nanoscopic crossed arrays. In another technique, microcontact printing can be used to apply patterned SAM to the substrate. Next, open areas in the patterned surface (the SAM-free linear region between linear SAM) are filled with an amino-terminated SAM that interacts in a highly specific manner with a nanowire such as a nanotube. The result is a patterned SAM, on a substrate, including linear SAM portions separated by a line of amino-terminated SAM material. Of course, any desired pattern can be formed where regions of the amino-terminated SAM material corresponds to regions at which wire deposition is desired. The patterned surface then is dipped into a suspension of wires, e.g. nanotubes, and rinsed to create an array in which wires are located at regions of the SAM. Where nanotubes are used, an organic solvent such as dimethyl formamide can be used to create the suspension of nanotubes. Suspension and deposition of other nanowires is achievable with easily selected solvents.

30 [0073] Any of a variety of substrates and SAM-forming materials can be used along with microcontact printing techniques, such as those described in International Patent Publication WO 96/29629 of Whitesides, et al., published June 26, 1996 and incorporated herein by reference. Patterned SAM surfaces can be used to direct a variety of nanowires or nanoscale electronic elements. SAM-forming material can be selected, with suitable exposed chemical functionality, to direct assembly of a variety of electronic elements. Electronic elements, including nanotubes, can be chemically tailored to be attracted specifically to specific, predetermined areas of a patterned SAM surface. Suitable functional groups include, but are not limited to SH, NH_3 , and the like. Nanotubes are particularly suitable for chemical functionalization on their exterior surfaces, as is well known.

35 [0074] Chemically patterned surfaces other than SAM-derivatized surfaces can be used, and many techniques for chemically patterning surfaces are known. Suitable exemplary chemistries and techniques for chemically patterning surfaces are described in, among other places, International Patent Publication No. WO 97/34025 of Hidber, et al, entitled, "Microcontact Printing of Catalytic Colloids", and U.S. Patent Nos. 3,873,359; 3,873,360; and 3,900,614, each by Lando, all of these documents incorporated herein by reference. Another example of a chemically patterned surface is a micro-phase separated block copolymer structure. These structures provide a stack of dense lamellar phases. A cut through these phases reveals a series of "lanes" wherein each lane represents a single layer. The block copolymer is typically an alternating block and can provide varying domains by which to dictate growth and assembly of a nanowire. Additional techniques are described in International Patent Publication No. WO 01/03208 published January 11, 2001 by Lieber, et al., incorporated herein by reference.

40 [0075] Chemical changes associated with the nanowires used in the invention can modulate the properties of the wires and create electronic devices of a variety of types. Presence of the analyte can change the electrical properties

of the nanowire through electrocoupling with a binding agent of the nanowire. If desired, the nanowires can be coated with a specific reaction entity, binding partner or specific binding partner, chosen for its chemical or biological specificity to a particular analyte.

5 [0076] The reaction entity is positioned relative to the nanowire to cause a detectable change in the nanowire. The reaction entity may be positioned within 100 nanometers of the nanowire, preferably within 50 nanometers of the nanowire, and more preferably within 10 nanometers of the nanowire, and the proximity can be determined by those of ordinary skill in the art. In one embodiment, the reaction entity is positioned less than 5 nanometers from the nanoscopic wire. In alternative embodiments, the reaction entity is positioned with 4 nm, 3 nm, 2 nm, and 1 nm of the nanowire. In a preferred embodiment, the reaction entity is attached to the nanowire through a linker.

10 [0077] As used herein, "attached to," in the context of a species relative to another species or to a surface of an article, means that the species is chemically or biochemically linked via covalent attachment, attachment via specific biological binding (e.g., biotin/streptavidin), coordinative bonding such as chelate/metal binding, or the like. For example, "attached" in this context includes multiple chemical linkages, multiple chemical/biological linkages, etc., including, but not limited to, a binding species such as a peptide synthesized on a polystyrene bead, a binding species specifically biologically coupled to an antibody which is bound to a protein such as protein A, which is covalently attached to a bead, a binding species that forms a part (via genetic engineering) of a molecule such as GST or, which in turn is specifically biologically bound to a binding partner covalently fastened to a surface (e.g., glutathione in the case of GST), etc. As another example, a moiety covalently linked to a thiol is adapted to be fastened to a gold surface since thiols bind gold covalently. "Covalently attached" means attached via one or more covalent bonds. E.g. a species that is covalently coupled, via EDC/NHS chemistry, to a carboxylate-presenting alkyl thiol which is in turn attached to a gold surface, is covalently attached to that surface.

15 [0078] Another aspect of the invention involves an article comprising a sample exposure region and a nanowire able to detect the presence or absence of an analyte. The sample exposure region may be any region in close proximity to the nanowire wherein a sample in the sample exposure region addresses at least a portion of the nanowire. Examples of sample exposure regions include, but are not limited to, a well, a channel, a microchannel, and a gel. In preferred embodiments, the sample exposure region holds a sample proximate the nanowire, or may direct a sample toward the nanowire for determination of an analyte in the sample. The nanowire may be positioned adjacent to or within the sample exposure region. Alternatively, the nanowire may be a probe that is inserted into a fluid or fluid flow path. The nanowire probe may also comprise a micro-needle and the sample exposure region may be addressable by a biological sample. In this arrangement, a device that is constructed and arranged for insertion of a micro-needle probe into a biological sample will include a region surrounding the micro-needle that defines the sample exposure region, and a sample in the sample exposure region is addressable by the nanowire, and vice-versa. Fluid flow channels can be created at a size and scale advantageous for use in the invention (microchannels) using a variety of techniques such as those described in International Patent Publication No. WO 97/33737, published September 18, 1997, and incorporated herein by reference.

25 [0079] In another aspect of the invention, an article may comprise a plurality of nanowires able to detect the presence or absence of a plurality of one or more analytes. The individual nanowires may be differentially doped as described above, thereby varying the sensitivity of each nanowire to the analyte. Alternatively, individual nanowires may be selected based on their ability to interact with specific analytes, thereby allowing the detection of a variety of analytes. The plurality of nanowires may be randomly oriented or parallel to one another. Alternatively, the plurality of nanowires may be oriented in an array on a substrate.

30 [0080] Fig. 1a shows one example of an article of the present invention. In Fig. 1a, nanoscale detector device 10 is comprised of a single nanowire 38 positioned above upper surface 18 of substrate 16. Chip carrier 12 has an upper surface 14 for supporting substrate 16 and electrical connections 22. Chip carrier 12, may be made of any insulating material that allows connection of electrical connections 22 to electrodes 36. In a preferred embodiment, the chip carrier is an epoxy. Upper surface 14 of the chip carrier, may be of any shape including, for example, planar, convex, and concave. In a preferred embodiment, upper surface 14 of the chip carrier is planar.

35 [0081] As shown in Fig. 1a, lower surface 20 of substrate 16 is positioned adjacent to upper surface 14 of the chip carrier and supports electrical connection 22. Substrate 16 may typically be made of a polymer, silicon, quartz, or glass, for example. In a preferred embodiment, the substrate 16 is made of silicon coated with 600 nm of silicon oxide. Upper surface 18 and lower surface 20 of substrate 16 may be of any shape, such as planar, convex, and concave. In a preferred embodiment, lower surface 20 of substrate 16 contours to upper surface 14 of chip carrier 12. Similarly, mold 24 has an upper surface 26 and a lower surface 28, either of which may be of any shape. In a preferred embodiment, lower surface 26 of mold 24 contours to upper surface 18 of substrate 16.

40 [0082] Mold 24 has a sample exposure region 30, shown here as a microchannel, having a fluid inlet 32 and fluid outlet 34, shown in Fig. 1a on the upper surface 26 of mold 24. Nanowire 38 is positioned such that at least a portion of the nanowire is positioned within sample exposure region 30. Electrodes 36 connect nanowire 38 to electrical connection 22. Electrical connections 22 are, optionally, connected to a detector (not shown) that measures a change in an electrical,

or other property of the nanowire. Figs. 3 a and 3b are low and high resolution scanning electron micrographs, respectively, of one embodiment of the present invention. A single silicon nanowire 38 is connected to two metal electrodes 36. Fig. 7 shows an atomic force microscopy image of a typical SWNT positioned with respect to two electrodes. As seen in Fig. 7, the distance between electrodes 36 is about 500 nm. In certain preferred embodiments, electrode distances will range from 50 nm to about 20000 nm, more preferably from about 100 nm to about 10000 nm, and most preferably from about 500 nm to about 5000 nm.

[0083] Where a detector is present, any detector capable of determining a property associated with the nanowire can be used. The property can be electronic, optical, or the like. An electronic property of the nanowire can be, for example, its conductivity, resistivity, etc. An optical property associated with the nanowire can include its emission intensity, or emission wavelength where the nanowire is an emissive nanowire where emission occurs at a p-n junction. For example, the detector can be constructed for measuring a change in an electronic or magnetic property (e.g. voltage, current, conductivity, resistance, impedance, inductance, charge, etc.) can be used. The detector typically includes a power source and a voltmeter or amp meter. In one embodiment, a conductance less than 1 nS can be detected. In a preferred embodiment, a conductance in the range of thousandths of a nS can be detected. The concentration of a species, or analyte, may be detected from less than micromolar to molar concentrations and above. By using nanowires with known detectors, sensitivity can be extended to a single molecule. In one embodiment, an article of the invention is capable of delivering a stimulus to the nanowire and the detector is constructed and arranged to determine a signal resulting from the stimulus. For example, a nanowire including a p-n junction can be delivered a stimulus (electronic current), where the detector is constructed and arranged to determine a signal (electromagnetic radiation) resulting from the stimulus. In such an arrangement, interaction of an analyte with the nanowire, or with a reaction entity positioned proximate the nanowire, can affect the signal in a detectable manner. In another example, where the reaction entity is a quantum dot, the quantum dot may be constructed to receive electromagnetic radiation of one wavelength and emit electromagnetic radiation of a different wavelength. Where the stimulus is electromagnetic radiation, it can be affected by interaction with an analyte, and the detector can detect a change in a signal resulting therefrom. Examples of stimuli include a constant current/voltage, an alternating voltage, and electromagnetic radiation such as light.

[0084] In one example, a sample, such as a fluid suspected of containing an analyte that is to be detected and/or quantified, e.g. a specific chemical contacts nanoscopic wire 38 having a corresponding reaction entity at or near nanoscopic wire 38. An analyte present in the fluid binds to the corresponding reaction entity and causes a change in electrical properties of the nanowire that is detected, e.g. using conventional electronics. If the analyte is not present in the fluid, the electrical properties of the nanowire will remain unchanged, and the detector will measure a zero change. Presence or absence of a specific chemical can be determined by monitoring changes, or lack thereof, in the electrical properties of the nanowire. The term "determining" refers to a quantitative or qualitative analysis of a species via, piezoelectric measurement, electrochemical measurement, electromagnetic measurement, photodetection, mechanical measurement, acoustic measurement, gravimetric measurement and the like. "Determining" also means detecting or quantifying interaction between species, e.g. detection of binding between two species.

[0085] Particularly preferred flow channels 30 for use in this invention are "microchannels". The term microchannel is used herein for a channel having dimensions that provide low Reynolds number operation, i.e., for which fluid dynamics are dominated by viscous forces rather than inertial forces. Reynolds number, sometimes referred to the ratio of inertial forces to viscous forces is given as:

$$Re = \rho d^2 / \eta \tau + \rho u d / \eta$$

where u is the velocity vector, ρ is the fluid density, η is the viscosity of the fluid, d is the characteristic dimension of the channel, and τ is the time scale over which the velocity is changing (where $u/\tau = \delta u / dt$). The term "characteristic dimension" is used herein for the dimension that determines Reynolds number, as is known in the art. For a cylindrical channel it is the diameter. For a rectangular channel, it depends primarily on the smaller of the width and depth. For a V-shaped channel it depends on the width of the top of the "V", and so forth. Calculation of Re for channels of various morphologies can be found in standard texts on fluid mechanics (e.g. Granger (1995) Fluid Mechanics, Dover, N.Y.; Meyer (1982) Introduction to Mathematical Fluid Dynamics, Dover, N.Y.).

[0086] Fluid flow behavior in the steady state ($\tau \rightarrow$ infinity) is characterized by the Reynolds number, $Re = \rho u d / \eta$. Because of the small sizes and slow velocities, microfabricated fluid systems are often in the low Reynolds number regime (Re less than about 1). In this regime, inertial effects, that cause turbulence and secondary flows, and therefore mixing within the flow, are negligible and viscous effects dominate the dynamics. Under these conditions, flow through the channel is generally laminar. In particularly preferred embodiments, the channel with a typical analyte-containing fluid provides a Reynolds number less than about 0.001, more preferably less than about 0.0001.

[0087] Since the Reynolds number depends not only on channel dimension, but on fluid density, fluid viscosity, fluid

velocity and the timescale on which the velocity is changing, the absolute upper limit to the channel diameter is not sharply defined. In fact, with well designed channel geometries, turbulence can be avoided for $R < 100$ and possibly for $R < 1000$, so that high throughput systems with relatively large channel sizes are possible. The preferred channel characteristic dimension range is less than about 1 millimeter, preferably less than about 0.5 mm, and more preferably less than about 200 microns.

[0088] In one embodiment, the sample exposure region, such as a fluid flow channel 30 may be formed by using a polydimethyl siloxane (PDMS) mold. Channels can be created and applied to a surface, and a mold can be removed. In certain embodiments, the channels are easily made by fabricating a master by using photolithography and casting PDMS on the master, as described in the above-referenced patent applications and international publications. Larger-scale assembly is possible as well.

[0089] Fig. 1b shows an alternative embodiment of the present invention wherein the nanoscale detector device 10 of Fig. 1a further includes multiple nanowires 38a-h (not shown). In Fig. 1b, wire interconnects 40a-h connect corresponding nanowires 38a-h to electrical connections 22a-h, respectively (not shown). In a preferred embodiment, each nanowire 38a-h has a unique reaction entity selected to detect a different analytes in the fluid. In this way, the presence or absence of several analytes may be determined using one sample while performing one test.

[0090] Fig. 2a schematically shows a portion of a nanoscale detector device in which the nanowire 38 has been modified with a reactive entity that is a binding partner 42 for detecting analyte 44. Fig. 2b schematically shows a portion of the nanoscale detector device of Fig. 2a, in which the analyte 44 is attached to the specific binding partner 42. Selectively functionalizing the surface of nanowires can be done, for example, by functionalizing the nanowire with a siloxane derivative. For example, a nanowire may be modified after construction of the nanoscale detector device by immersing the device in a solution containing the modifying chemicals to be coated. Alternatively, a microfluidic channel may be used to deliver the chemicals to the nanowires. For example, amine groups may be attached by first making the nanoscale detector device hydrophilic by oxygen plasma, or an acid and/or oxidizing agent and the immersing the nanoscale detector device in a solution containing amino silane. By way of example, DNA probes may be attached by first attaching amine groups as described above, and immersing the modified nanoscale detector device in a solution containing bifunctional crosslinkers, if necessary, and immersing the modified nanoscale detector device in a solution containing the DNA probe. The process may be accelerated and promoted by applying a bias voltage to the nanowire, the bias voltage can be either positive or negative depending on the nature of reaction species, for example, a positive bias voltage will help to bring negatively charged DNA probe species close to the nanowire surface and increase its reaction chance with the surface amino groups.

[0091] Fig. 4a schematically shows another embodiment of a nanoscale sensor having a backgate 46. Figs. 4b shows conductance vs. time at with a backgate voltage ranging from -10V to +10V. Fig. 4c shows conductance vs. backgate voltage. The backgate can be used to inject or withdraw the charge carriers from the nanowire. Therefore, it may be used to control the sensitivity and the dynamic range of the nanowire sensor and to draw analytes to the nanowire.

[0092] Figs. 5a and 5b show the conductance for a single silicon nanowire, native and coated, respectively, as a function of pH. As seen in Fig. 4, the conductance of the silicon nanowire changes from 7 to 2.5 when the sample is changed. The silicon nanowire of Fig. 5 has been modified to expose amine groups at the surface of the nanowire. Fig. 5 shows a change in response to pH when compared to the response in Fig. 4. The modified nanowire of Fig. 5 shows a response to milder conditions such as, for example, those present in physiological conditions in blood.

[0093] Fig. 6 shows the conductance for a silicon nanowire having a surface modified with an oligonucleotide agent reaction entity. The conductance changes dramatically where the complementary oligonucleotide analyte binds to the attached oligonucleotide agent.

[0094] Fig. 8a shows the change in the electrostatic environment with change in gate voltage for a single-walled nanotube. Figs. 8b and c, show the change in conductance induced by the presence of NaCl and CrCl₃ of a single-walled carbon nanotube.

[0095] Fig. 9a shows the change in conductance as nanosensors with hydroxyl surface groups are exposed to pH levels from 2 to 9. Fig 9b shows the change in conductance as nanosensors modified with amine groups are exposed to pH levels from 2 to 9. Fig. 9c show the relative conductance of the nanosensors with changes in pH levels. The results showed a linear response in a wide range of pH, which clearly demonstrated the device is suitable for measuring or monitoring pH conditions of a physiological fluid.

[0096] Fig. 10a shows an increase in conductance of a silicon nanowire(SiNW) modified with a reaction entity BSA Biotin, as it is exposed first to a blank buffer solution, and then to a solution containing an analyte, 250 nM Streptavidin. Fig. 10b shows an increase in conductance of a SiNW modified with BSA Biotin, as it is exposed first to a blank buffer solution, and then to a solution containing 25 pM Streptavidin. Fig. 10c shows no change in conductance of a bare SiNW as it is exposed first to a blank buffer solution, and then to a solution containing Streptavidin. Fig. 10d shows the conductance of a SiNW modified with BSA Biotin, as it is exposed to a buffer solution, and then to a solution containing d-biotin Streptavidin. Fig. 10e shows the change in conductance of a Biotin modified nanosensor exposed to a blank buffer solution, then to a solution containing Streptavidin, and then again to a blank buffer solution. Replacing Streptavidin

with the blank buffer does not change the conductance, indicating that the Streptavidin has irreversibly bound to the BSA Biotin modified nanosensor. Fig. 10f shows no change in conductance of a bare SiNW as it is alternately exposed to a buffer solution and a solution containing streptavidin. These results demonstrate the nanowire sensor is suitable for specific detection of bio-markers at very high sensitivity.

5 **[0097]** Fig. 11a shows a decrease in conductance of a BSA-Biotin modified SiNW as it is exposed first to a blank buffer solution, then to a solution containing antibiotin. The conductance then increases upon replacing the solution containing antibiotin with a blank buffer solution, and then again decreases upon exposing the nanosensor to a solution containing antibiotin. Fig. 11a indicates a reversible binding between biotin and antibiotin. Fig. 11b shows the conductance of a bare SiNW during contact with a buffer solution and then a solution containing antibiotin. Fig. 11c shows the change in conductance of a BSA-Biotin modified SiNW during exposure to a buffer, other IgG type antibodies, and then antibiotin, an IgG1 type antibody to biotin. Fig. 11c indicates that the BSA biotin modified SiNW detects the presence of antibiotin, without being hindered by the presence of other IgG type antibodies. These results demonstrate the potential of the nanowire sensor for dynamic bio-marker monitoring under a real physiological condition.

10 **[0098]** Amine modified SiNW may also detect the presence of metal ions. Fig. 12a shows the change in conductance of an amine modified SiNW when alternately exposed to a blank buffer solution and a solution containing 1mM Cu(II). Fig. 12b shows the increases in conductance as the amine modified SiNW is exposed to concentrations of Cu(II) from 0.1 mM to 1mM. Fig. 12c shows the increase in conductance verses Cu(II) concentration. Fig. 12d shows no change in conductance of an unmodified SiNW when exposed first to a blank buffer solution and then to 1mM Cu(II). Fig. 12e shows no change in the conductance of an amine modified SiNW when exposed first to a blank buffer solution and then to 1mM Cu(II)-EDTA, wherein the EDTA interferes with the ability of Cu(II) to bind to the modified SiNW. These results demonstrate the potential of the nanowire sensor for use in inorganic chemical analysis.

15 **[0099]** Fig. 13a shows the conductance of a silicon nanowire modified with calmodulin, a calcium binding protein. In fig. 13a, region 1 shows the conductance of the calmodulin modified silicon when exposed to a blank buffer solution. Region 2 shows the drop in conductance of the same nanowire when exposed to a solution containing calcium ions noted in fig. 3 with a downward arrow. Region 3 shows the increase in conductance of the same nanowire is again contacted with a blank buffer solution, indicated with an upward arrow. The subsequent return of conductance to its original level indicates that the calcium ion is reversible bound to the calmodulin modified nanowire. Fig. 13b shows no change in conductance of an unmodified nanowire when exposed first to a blank buffer solution, and then to a solution containing calcium ions.

20 **[0100]** As indicated by the disclosure above, in one embodiment, the invention provides a nanoscale electrically based sensor for determining the presence or absence of analytes suspected of being present in a sample. The nanoscale provides greater sensitivity in detection than that provided by macroscale sensors. Moreover, the sample size used in nanoscale sensors is less than or equal to about 10 microliters, preferably less than or equal to about 1 microliter, and more preferably less than or equal to about 0.1 microliter. The sample size may be as small as about 10 nanoliters or less. The nanoscale sensor also allows for unique accessibility to biological species and may be used both in vivo and in vitro applications. When used in vivo, the nanoscale sensor and corresponding method result in a minimally invasive procedure.

25 **[0101]** Fig. 14a shows a calculation of sensitivity for detecting up to 5 charges compared to the doping concentration and nanowire diameter. As indicated, the sensitivity of the nanowire may be controlled by changing the doping concentration or by controlling the diameter of the nanowire. For example, increasing the doping concentration of a nanowire increases the ability of the nanowire to detect more charges. Also, a 20 nm wire requires less doping than a 5 nm nanowire for detecting the same number of charges. Fig. 14b shows a calculation of a threshold doping density for detecting a single charge compared to the diameter of a nanowire. Again, a 20 nm nanowire requires less doping than a 5 nm nanowire to detect a single charge.

30 **[0102]** Fig. 15 a shows a schematic view of an InP nanowire. The nanowire may be homogeneous, or may comprise discrete segments of n and p type dopants. Fig. 15b shows the change in luminescence of the nanowire of 15a over time as pH is varied. As indicated, the intensity of the light emission of a nanowire changes relative to the level of binding. As the pH increases, the light intensity drops, and as the pH decreases, the light intensity increases. One embodiment of the invention contemplates individually addressed light signal detection by sweeping through each electrode in a microarray. Another embodiment of the invention contemplates a two signal detector, such as, an optical sensor combined with an electrical detector.

35 **[0103]** Fig. 16a depicts one embodiment of a nanowire sensor. As show in Fig. 16a, the nanowire sensor of the invention comprises a single molecule of doped silicon 50. The doped silicon is shaped as a tube, and the doping can be n-doped or p-doped. Either way, the doped silicon nanowire forms a high resistance semiconductor material across which a voltage may be applied. The exterior surface and the interior surface of the tube will have an oxide formed thereon and the surface of the tube can act as the gate 52 of an FET device and the electrical contacts at either end of the tube allow the tube ends to acts as the drain 56 and the source 58. In the depicted embodiment the device is symmetric and either end of the device may be considered the drain or the source. For purpose of illustration, the

nanowire of Fig. 16a defines the left-hand side as the source and the right hand side as the drain. Fig. 16a also show that the nanowire device is disposed upon and electrically connected to two conductor elements 54.

5 **[0104]** Figs. 16a and 16b illustrate an example of a chemical /or ligand-gated Field Effects Transistor (FET). FETs are well know in the art of electronics. Briefly, a FET is a 3-terminal device in which a conductor between 2 electrodes, one connected to the drain and one connected to the source, depends on the availability of charge carriers in a channel between the source and drain. FETs are described in more detail in The Art of Electronics, Second Edition by Paul Horowitz and Winfield Hill, Cambridge University Press, 1989, pp. 113-174, the entire contents of which is hereby incorporated by reference. This availability of charge carriers is controlled by a voltage applied to a third "control electrode" also know as the gate electrode. The conduction in the channel is controlled by a voltage applied to the gate electrode which produces an electric field across the channel. The device of Figs. 16a and 16b may be considered a chemical or ligand-FET because the chemical or ligand provides the voltage at the gate which produced the electric field which changes the conductivity of the channel. This change in conductivity in the channel effects the flow of current through the channel. For this reason, a FET is often referred to as a transconductant device in which a voltage on the gate controls the current through the channel through the source and the drain. The gate of a FET is insulated from the conduction channel, for example, using a semi conductor junction such in a junction FET (JFET) or using an oxide insulator such as in a metal oxide semiconductor FET (MOSFET). Thus, in Figures A and B, the SIO₂ exterior surface of the nanowire sensor may serve as the gate insulation for the gate.

10 **[0105]** In application, the nanowire device illustrated in Figure A provides an FET device that may be contacted with a sample or disposed within the path of a sample flow. Elements of interest within the sample can contact the surface of the nanowire device and, under certain conditions, bind or otherwise adhere to the surface.

15 **[0106]** To this end the exterior surface of the device may have reaction entities, e.g., binding partners that are specific for a moiety of interest. The binding partners will attract the moieties or bind to the moieties so that moieties of interest within the sample will adhere and bind to the exterior surface of the nanowire device. An example of this is shown in Fig. 16c where there is depicted a moiety of interest 60 (not drawn to scale) being bound to the surface of the nanowire device.

20 **[0107]** Also shown, with reference to Fig. 16c, that as the moieties build up, a depletion region 62 is created within the nanowire device that limits the current passing through the wire. The depletion region can be depleted of holes or electrons, depending upon the type of channel. This is shown schematically in Fig. 16d below. The moiety has a charge that can lead to a voltage difference across the gate/drain junction.

25 **[0108]** A nanoscale sensor of the present invention can collect real time data. The real time data may be used, for example, to monitor the reaction rate of a specific chemical or biological reaction. Physiological conditions or drug concentrations present in vivo may also produce a real time signal that may be used to control a drug delivery system. For example, the present invention includes, in one aspect, an integrated system, comprising a nanowire detector, a reader and a computer controlled response system. In this example, the nanowire detects a change in the equilibrium of an analyte in the sample, feeding a signal to the computer controlled response system causing it to withhold or release a chemical or drug. This is particularly useful as an implantable drug or chemical delivery system because of its small size and low energy requirements. Those of ordinary skill in the art are well aware of the parameters and requirements for constructing implantable devices, readers, and computer-controlled response systems suitable for use in connection with the present invention. That is, the knowledge of those of ordinary skill in the art, coupled with the disclosure herein of nanowires as sensors, enables implantable devices, real-time measurement devices, integrated systems, and the like. Such systems can be made capable of monitoring one, or a plurality of physiological characteristics individually or simultaneously. Such physiological characteristics can include, for example, oxygen concentration, carbon dioxide concentration, glucose level, concentration of a particular drug, concentration of a particular drug by-product, or the like. Integrated physiological devices can be constructed to carry out a function depending upon a condition sensed by a sensor of the invention. For example, a nanowire sensor of the invention can sense glucose level and, based upon the determined glucose level can cause the release of insulin into a subject through an appropriate controller mechanism.

30 **[0109]** In another embodiment, the article may comprise a cassette comprising a sample exposure region and a nanowire. The detection of an analyte in a sample in the sample exposure region may occur while the cassette is disconnected to a detector apparatus, allowing samples to be gathered at one site, and detected at another. The cassette may be operatively connectable to a detector apparatus able to determine a property associated with the nanowire. As used herein, a device is "operatively connectable" when it has the ability to attach and interact with another apparatus.

35 **[0110]** In another embodiment, one or more nanowires may be positioned in a microfluidic channel. One or more different nanowires may cross the same microchannel at different positions to detect a different analyte or to measure flow rate of the same analyte. In another embodiment, one or more nanowires positioned in a microfluidic channel may form one of a plurality of analytic elements in a micro needle probe or a dip and read probe. The micro needle probe is implantable and capable of detecting several analytes simultaneously in real time. In another embodiment, one or more nanowires positioned in a microfluidic channel may form one of the analytic elements in a microarray for a cassette or a lab on a chip device. Those skilled in the art would know such cassette or lab on a chip device will be in particular

suitable for high throughput chemical analysis and combinational drug discovery. Moreover, the associated method of using the nanoscale sensor is fast and simple, in that it does not require labeling as in other sensing techniques. The ability to include multiple nanowires in one nanoscale sensor, also allows for the simultaneous detection of different analytes suspected of being present in a single sample. For example, a nanoscale pH sensor may include a plurality of nanoscale wires that each detect different pH levels, or a nanoscale oligo sensor with multiple nanoscale wires may be used to detect multiple sequences, or combination of sequences.

[0111] Those skilled in the art would readily appreciate that all parameters listed herein are meant to be exemplary and that actual parameters will depend upon the specific application for which the methods and apparatus of the present invention are used. It is, therefore, to be understood that the foregoing embodiments are presented by way of example only and that, within the scope of the appended claims and equivalents thereto, the invention may be practiced otherwise than as specifically described.

Claims

1. An article comprising: a sample exposure region, and a nanowire, at least a portion of which is addressable by a sample in the sample exposure region.
2. The article as in claim 1, further comprising: a detector constructed and arranged to determine a property associated with the nanowire.
3. The article as in claim 1, wherein the sample exposure region comprises a microchannel.
4. The article as in claim 1, wherein the sample exposure region comprises a well.
5. The article as in claim 1, wherein the nanowire is a semiconductor nanowire.
6. The article as in claim 5, wherein the semiconductor nanowire is a silicon nanowire, wherein the semiconductor nanowire contains a P-N junction, wherein the semiconductor nanowire contains multiple p- n junctions or wherein the semiconductor nanowire is one of plurality of nanowires wherein each of the plurality of nanowires is doped with different concentrations of a dopant.
7. The article as in claim 1, wherein the nanowire is a carbon nanotube.
8. The article as in claim 7, wherein the nanotube is a single-walled nanotube or wherein the nanotube is a multi-walled nanotube.
9. The article as in claim 1, wherein the nanowire is an unmodified nanowire.
10. The article as in claim 24, wherein the reaction entity comprises a binding partner of the analyte.
11. The article as in claim 10, wherein the binding partner is non-specific, wherein the binding partner is specific, wherein the binding partner comprises chemical group on the nanowire surface, wherein the combined selected from groups consisting of -OH, -CHO, -COOH, -SO₃H, -CN, -NH₂, -SH, -COSH, COOR, Halide, wherein the binding partner comprises a specific biomolecular receptor selected from the group consisting of DNA, fragments of a DNA, antibody, antigen, protein, and enzyme, wherein the binding partner comprises short polymer chains grafted on the nanowire surface, wherein the chains are selected form a group of polymers consisting of: polyamide, polyester, polyacrylic, polyimide, wherein the binding partner comprises a thin hydrogel layer coated on the surface of the nanowire or wherein the binding partner comprises a thin coating on the surface of nanowires, wherein the coating is selected form the group consisting of oxides, sulfides and selenides.
12. The article as in claim 1, wherein the nanowire comprises a chemical-gated nanowire field effect transistor wherein an electrical characteristic of the nanowire is sensitive to a chemical change on a surface of the nanowire.
13. The article as in claim 1, wherein the nanowire comprises a material selected from the group consisting of an

electroluminescent material, a photoluminescent material, and a diode, wherein a light emitting property of the nanowire is sensitive to a chemical change on a surface of the nanowire.

- 5 14. The article as in claim 1, further comprising a reaction entity positioned relative to the nanowire such that an interaction between the reaction entity and an analyte in the sample causes a detectable change in a property of the nanowire.
- 15 15. The article as in claim 14, wherein the reaction entity is selected from the group consisting of a nucleic acid, an antibody, a sugar, a carbohydrate, and a protein.
- 10 16. The article as in claim 14, wherein the reaction entity comprises a catalyst,
wherein the reaction entity comprises a quantum dot,
wherein the reaction entity comprises a polymer,
wherein the reaction entity is fastened to the nanowire,
wherein the reaction entity is positioned within 5 nanometers of the nanowire,
15 wherein the reaction entity is positioned within 3 nanometers of the nanowire,
wherein the reaction entity is positioned within 1 nanometer of the nanowire,
wherein the reaction entity is attached to the nanowire through a linker,
wherein the reaction entity is attached to the nanowire directly or
wherein the reaction entity is positioned relative to the nanowire such that it is electrically coupled to the nanowire
20 wherein a detectable interaction between an analyte in the sample and the reaction entity causes a detectable change in an electrical property of the nanowire.
- 25 17. An article as in claim 3, wherein the microchannel has a minimum lateral dimension less than 1 mm,
wherein the microchannel has a minimum lateral dimension less than 0.5 mm or
wherein the microchannel has a minimum lateral dimension less than 200 microns.
- 30 18. The article as in claim 1, wherein the nanowire is one of a plurality of nanowires comprising a sensor.
19. The article as in claim 18, wherein each of the plurality of the nanowires includes at least one portion positioned in the sample exposure region.
- 35 20. The article as in claim 18, wherein the plurality of nanowires comprises at least 10 nanowires.
21. The article as in claim 20, wherein the multiple nanowires are arranged in parallel and addressed by a single pair of the electrodes.
- 40 22. The article as in claim 20, wherein the multiple nanowires are arranged in parallel to each other and addressed individually by multiple pairs of electrodes.
23. The article as in claim 22, wherein the multiple nanowires are different, each capable of detecting a different analyte.
- 45 24. The article as in claim 20, wherein the multiple nanowires are oriented randomly.
25. The article as in claim 1, wherein the nanowire is positioned on the surface of a substrate.
- 50 26. The article as in claim 1, wherein the sample exposure region comprises a microchannel and the nanowire is suspended in the microchannel.
27. The article as in claim 1, where the article is one of a plurality of nanowire sensors in a sensor array formed on a surface of a substrate.
- 55 28. The article as in claim 27, wherein the substrate is selected from the group consisting of glass, silicon dioxide-coated silicon and a polymer.
29. The article as in claim 3, wherein the microchannel is dimensioned so as to produce a Reynolds number (Re) less than about 1 for a fluid comprising the sample.
30. The article as in claim 21, wherein the Reynolds number is less than about 0.01.

31. The article as in claim 1, constructed and arranged to receive a fluidic sample in the sample exposure region.
32. The article as in claim 23 wherein the sample is a gas stream or wherein the sample is a liquid.
- 5 33. The article as in claim 1, wherein the article comprises a plurality of nanowires and a plurality of reaction entities, at least some of which are positioned relative to the nanowires such that an interaction between the reaction entity and an analyte causes a detectable change in a property of a nanowire.
- 10 34. The article as in claim 33, wherein at least one reaction entity is positioned within 100 nanometers of a nanowire, wherein at least one reaction entity is positioned within 50 nanometers of a nanowire or or wherein at least one reaction entity is positioned within 10 nanometers of a nanowire.
- 15 35. The article as in claim 1, where in the sample exposure region is addressable by a biological sample.
36. The article as in claim 1, where the article forms sensing elements for a micro-needle probe.
37. The article as in claim 36, wherein the micro-needle is implantable into a living subject, wherein the article is a sensor capable of monitoring a physiological characteristic, wherein the sensor is capable of monitoring a plurality of physiological characteristics, wherein the article is capable of simultaneously monitoring a plurality of physiological characteristics, wherein the article is capable of determining at least one of oxygen concentration, carbon dioxide concentration, and glucose level in a subject.
- 20 38. The article as in claim 1, where the article forms sensing elements for an integrated dip-probe sensor or where the article forms sensing elements for a plug and play sensor array.
- 25 39. The article as in claim 2, wherein the article is capable of delivering a stimulus to the nanowire and the detector is constructed and arranged to determine a signal resulting from the stimulus.
- 30 40. The article as in claim 39, wherein the stimulus is selected from the group consisting of constant current/voltage, an alternating voltage, and electromagnetic radiation,
41. The article as in claim 2, wherein the detector is constructed and arranged to determine an electrical property associated with the nanowire, wherein the detector is constructed and arranged to determine a change in an electromagnetic property associated with a nanowire or where the detector is constructed and arranged to determine a change in a light emission property associated with the nanowire.
- 35 42. A method comprising:
contacting a nanowire with a sample suspected of containing an analyte; and
determining a change in a property of the nanowire.
- 40 43. The method as in claim 42, comprising first measuring a property of the nanowire, then contacting the nanowire with the sample, then determining a change in a property associated with the nanowire.
- 45 44. A method comprising:
providing an nanowire and contacting the nanowire with a sample having a volume of less than about 10 microliters; and
measuring a change in a property of the nanowire resultant from the contact.
- 50 45. A method comprising:
contacting a nanowire with a sample suspected of containing an analyte and determining the presence or quantity of the analyte by measuring a change in a property of the nanowire resulting from the contact, wherein
- 55

less than ten molecules of the analyte contribute to the change in the property detected.

46. The method of claim 45, wherein less than 5 molecules of the species contribute to the change in electrical property.

5 47. The method of claim 46, wherein one molecule of the species contributes to the change in electrical property detected.

48. An article comprising:

10 a sample cassette comprising a sample exposure region and a nanowire, at least a portion of which is addressable by a sample in the sample exposure region, wherein the sample cassette is operatively connectable to a detector apparatus able to determine a property associated with the nanowire.

49. A sensor comprising:

15 at least one nanowire; and means for measuring a change in a property of the at least one nanowire.

50. A method of detecting an analyte, comprising:

20 contacting a nanowire with a sample; and determining a property associated with the nanowire where a change in the property when the nanowire is contacted with the sample indicates the presence or quantity of the analyte in the sample.

51. A method comprising:

25 contacting an electrical conductor with a sample; and determining the presence or quantity of an analyte in the sample by measuring a change in a property of the conductor resultant from the contact, wherein less than ten molecules of the analyte contribute to the a change in said property.

30

52. An article comprising:

35 a nanowires core region and an outer region, wherein outer region comprises functional moieties which are chemically or physically bonded to the nanowire core.

35

53. The article as in claim 83, wherein the core is a semiconductor nanowire, comprising material selected from the group consisting of: Si, GaN, AlN, InN, GaAs, AlAs, InAs, InP, GaP, SiC, CdSe, ZnSe, ZnTe, ZnO, SnO₂, and TiO₂, wherein the nanowire core has a diameter ranging from 0.5 nm to 200 nm, wherein the nanowire core has an aspect ratio more than 2,

40

wherein the functional moieties at the outer region are groups or combinational groups selected from the groups consisting of -OH, -CHO, -COOH, -SO₃H, -CN, -NH₂, -SH, -COSH, COOR, and halide, wherein, the functional moieties are groups selected from the group consisting of amino acids, proteins, DNA, antibodies, antigens, and enzymes or

45

wherein the functional moieties comprise grafted polymer chains with chain length less than the diameter of the nanowire core, selected from a group of polymers including polyamide, polyester, polyimide, polyacrylic.

54. The article as in claim 52, where the functional moieties comprise a thin coating covering the surface of the nanowire core, selected from the group consisting of metals, semiconductors, and insulators.

50

55. The article as in claim 54, wherein the coating is selected from the group consisting of a metallic element, anoxide, a sulfide, a nitride, a selenide, a polymer, and a polymer gel.

56. A nanowire sensor device, comprising

55

a semiconductor nanowire having a first end in electrical contact with a conductor to form a source electrode, a second end in electrical contact with a conductor to form a drain electrode, and an exterior surface having an oxide formed thereon to form a gate electrode, and

a binding agent having specificity for a selected moiety and being bound to the exterior surface, whereby a voltage at the gate electrode varies in response to the binding of the moiety to the binding agent to provide a chemically

gated field effect sensor device.

57. A analyte-gated field effect transistor having a predetermined current-voltage characteristic and adapted for use as a chemical or biological sensor, comprising:

- 5
- (a) a substrate formed of a first insulating material;
 - (b) a source electrode disposed on the substrate;
 - (c) a drain electrode disposed on the substrate,
 - (c) a semiconductor nanowire disposed between the source and drain electrodes to form a field effect transistor having a predetermined current-voltage characteristic; and
 - (d) an analyte-specific binding agent disposed on a surface of the nanowire, wherein a binding event occurring between a target analyte and the binding agent causes a detectable change in the current-voltage characteristic of said field effect transistor.
- 10

15 **58.** The analyte-gated field effect transistor of claim 57, wherein the analyte is a chemical moiety.

59. The analyte-gated field effect transistor of claim 58, wherein the chemical moiety is a small organic compound. wherein the chemical moiety is an ion.

20 **60.** The analyte-gated field effect transistor of claim 57, wherein the analyte is a biological moiety.

61. The analyte-gated field effect transistor of claim 60, wherein the analyte is selected from the group consisting of proteins, nucleic acid, carbohydrates, lipids, and steroids.

25 **62.** An article comprising array of at least 100 of said analyte-gated field effect transistor of claim 57.

63. The article of claim 62, which is homogenous with respect to a population of analyte-specific binding agents associated with the article or which is heterologous with respect to a population of analyte-specific binding agents associated with the article.

30 **64.** The article as in claim 24, wherein the reaction entity is positioned relative to the nanowires such that it is optically coupled to the nanowire wherein a detectable interaction between an analyte in the sample and the reaction entity causes a detectable change in a property of the nanowire.

35

40

45

50

55

Fig. 1a

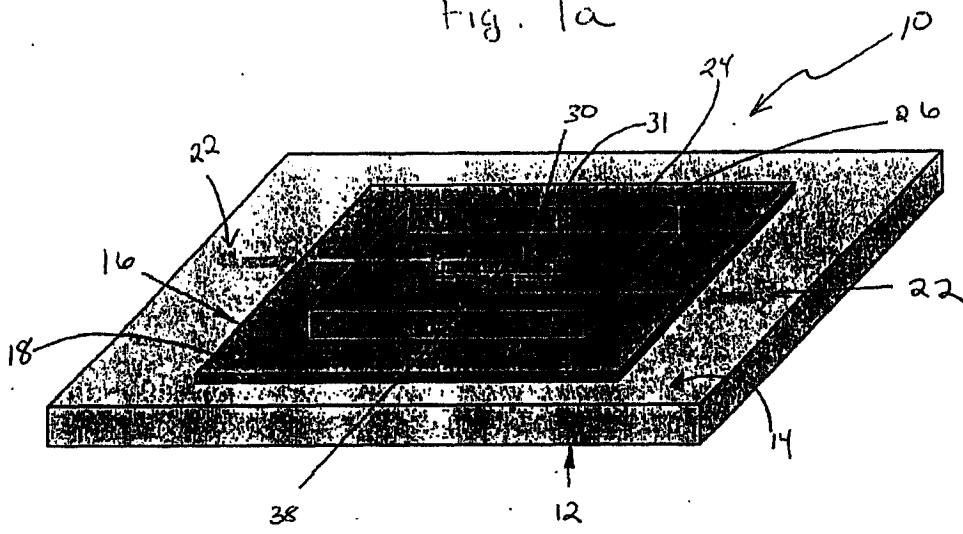
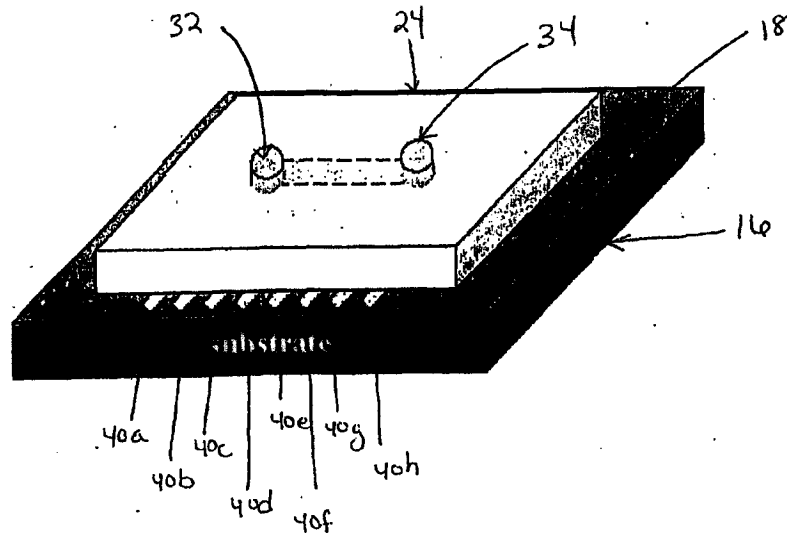

Fig. 1b



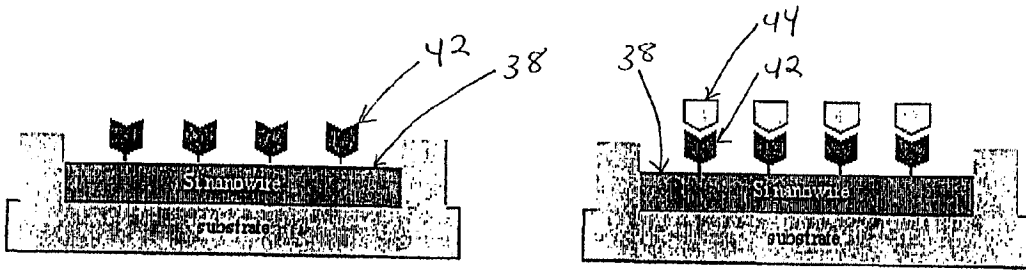

Figure 2a

Figure 2b

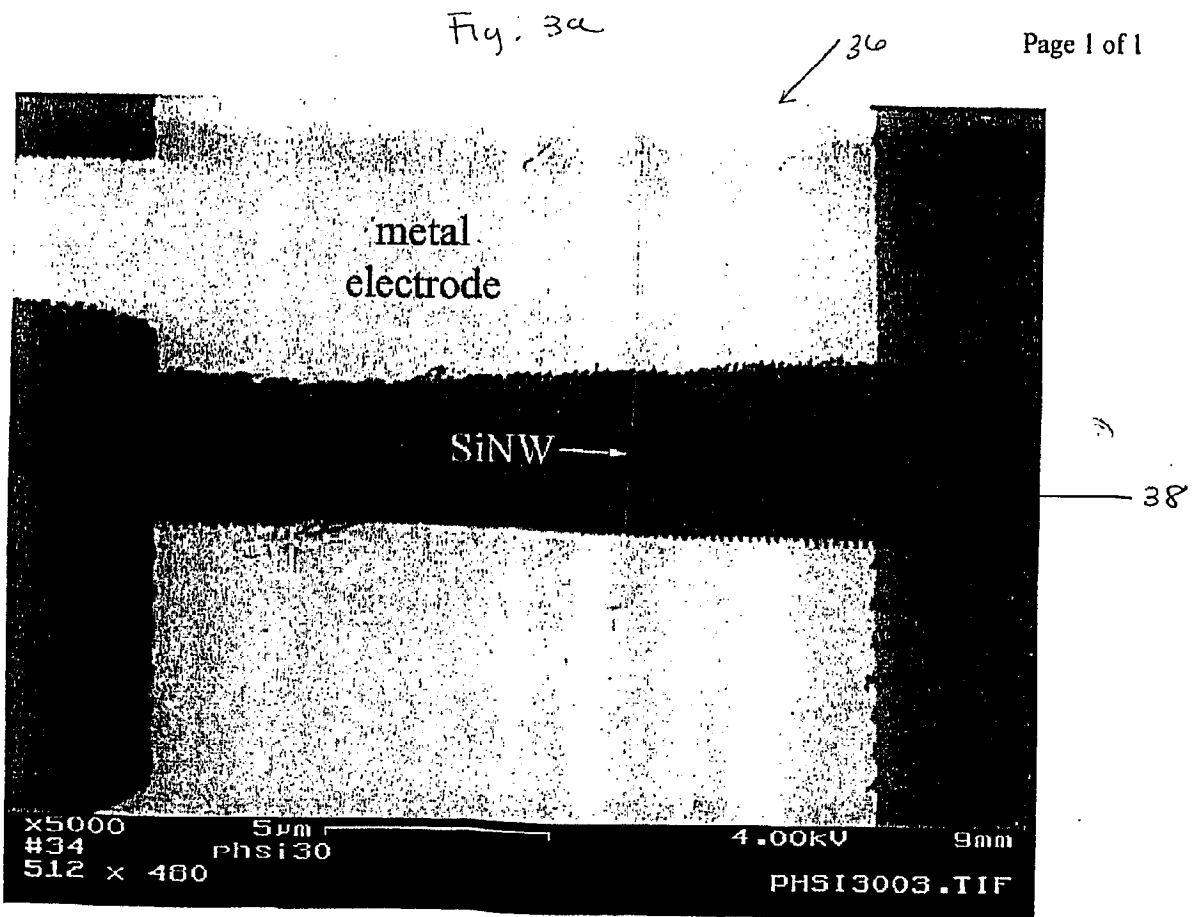
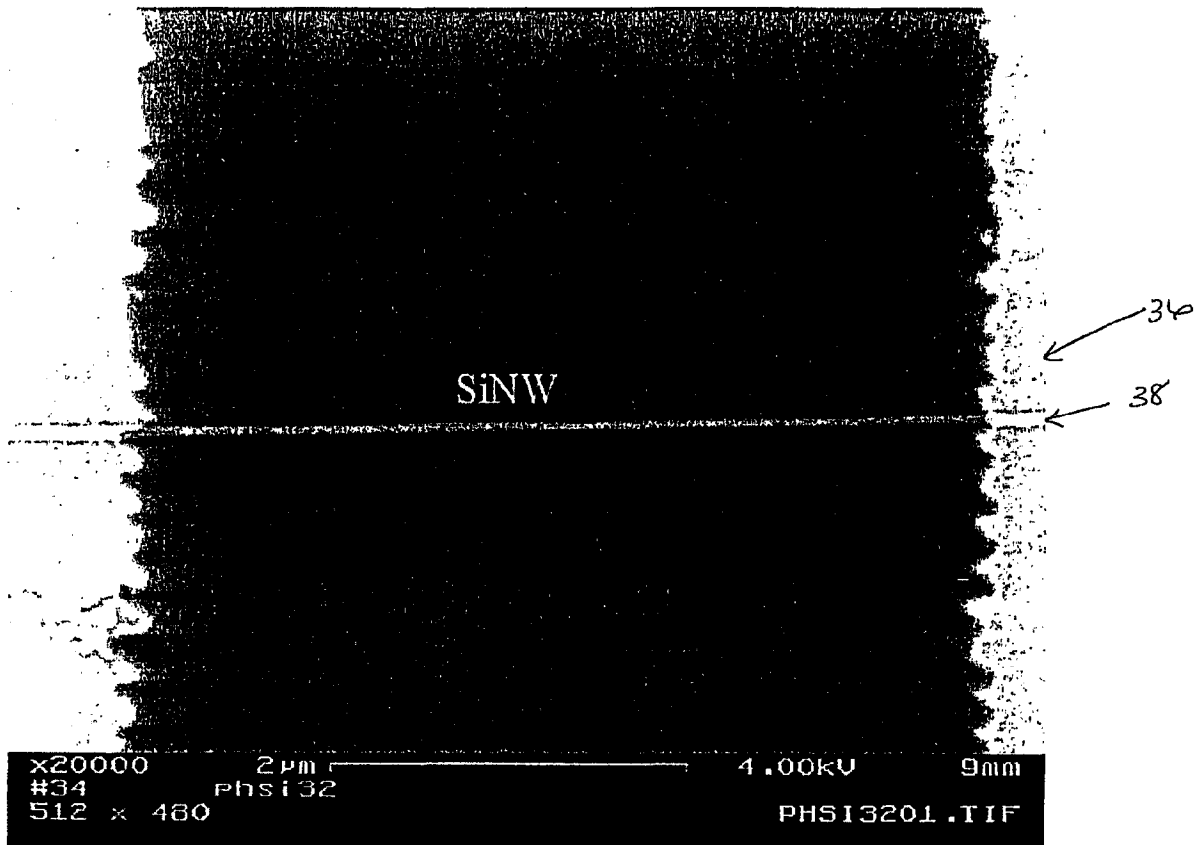

Fig 3b



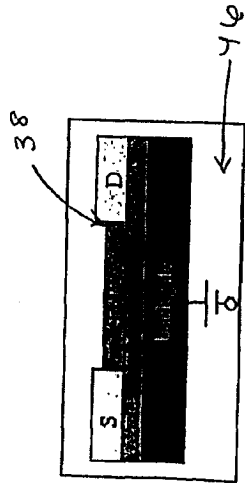
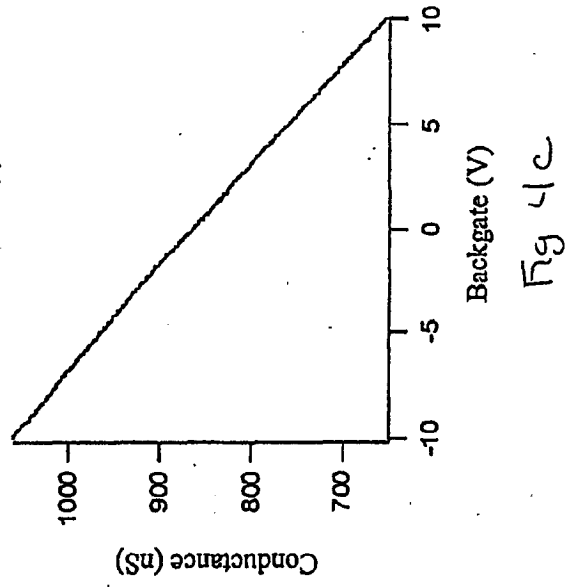
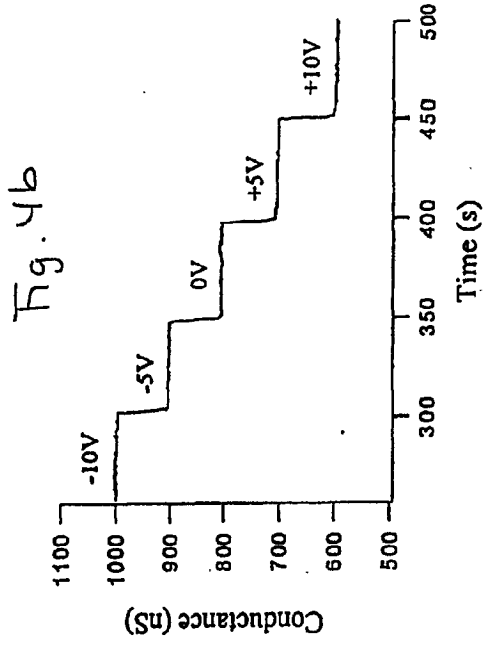

FIG. 5a

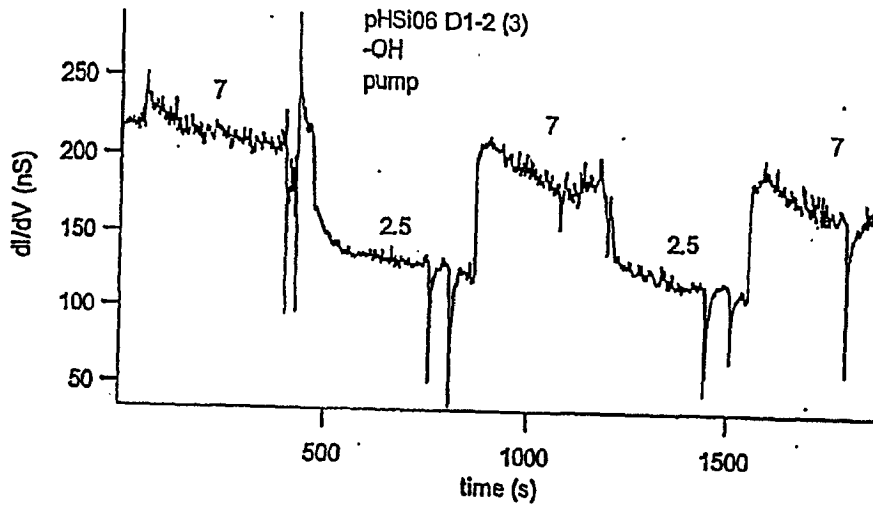

FIG. 5b

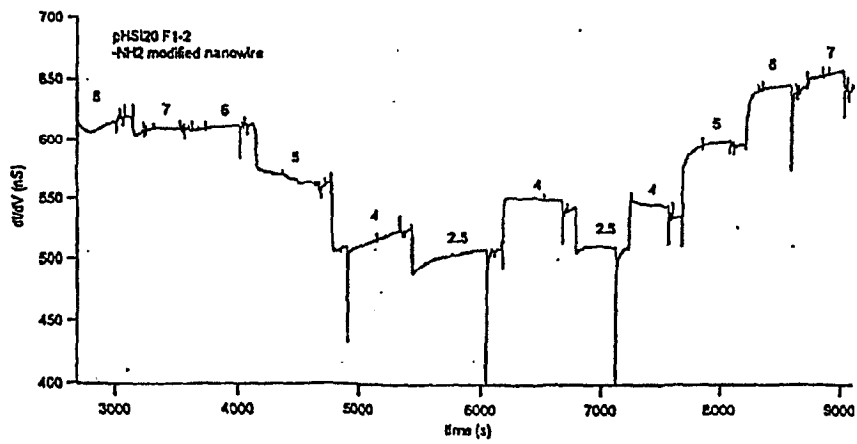

FIG. 6

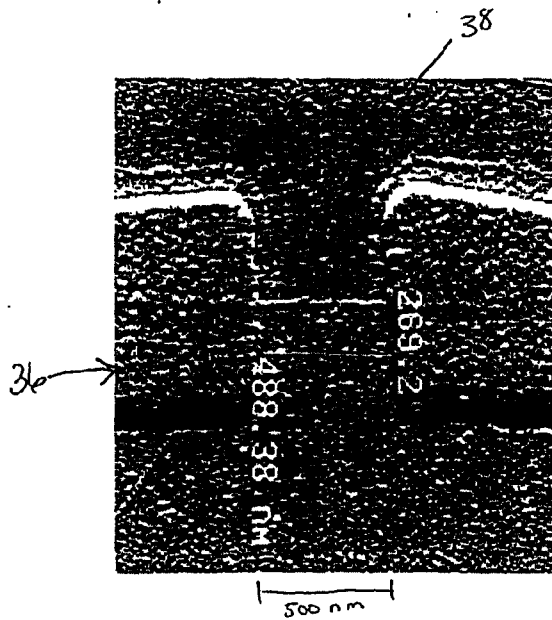
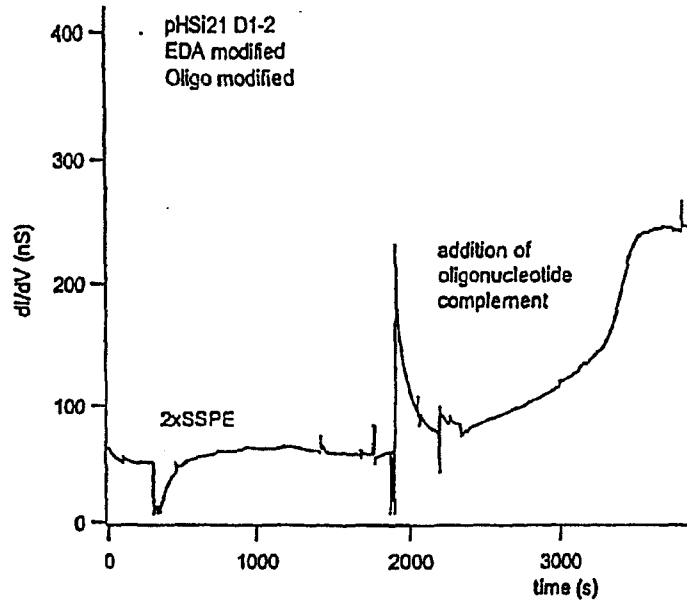

Fig. 7

FIG. 8a

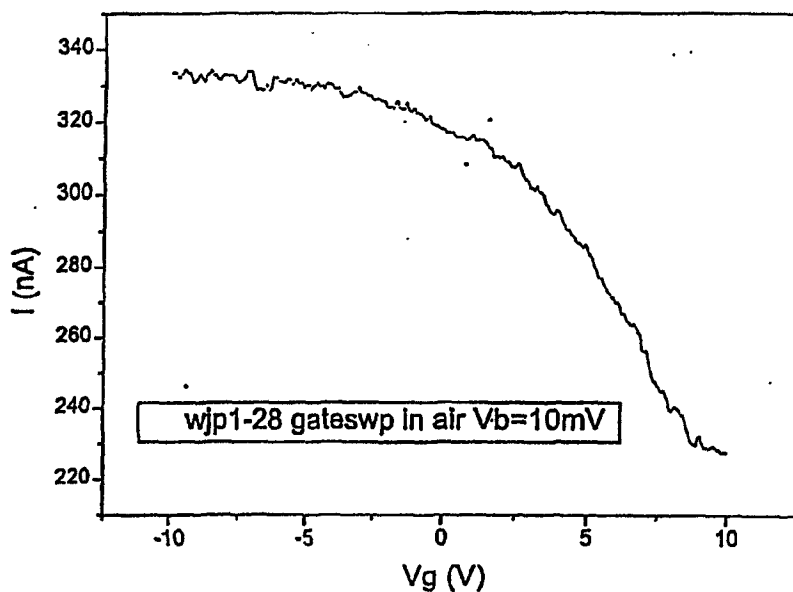

FIG. 8b

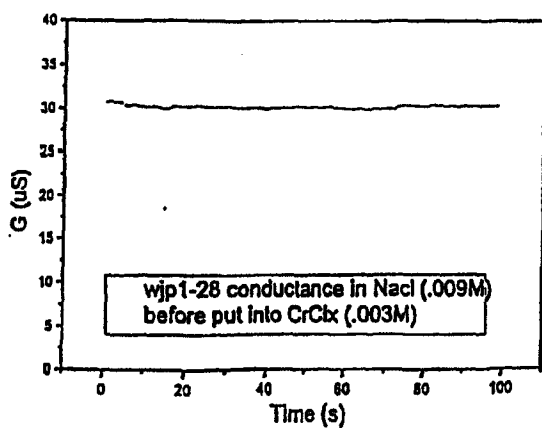

FIG. 8c

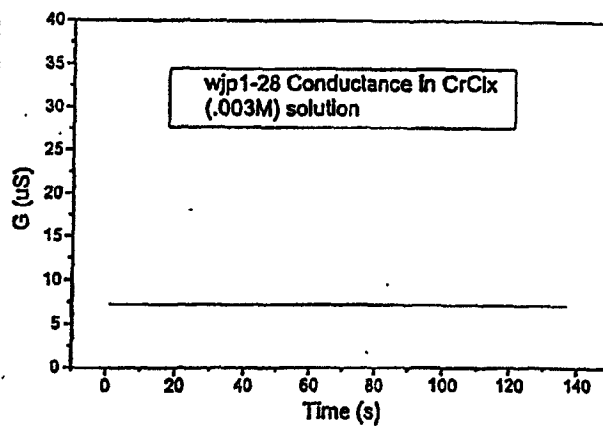

Fig 9A

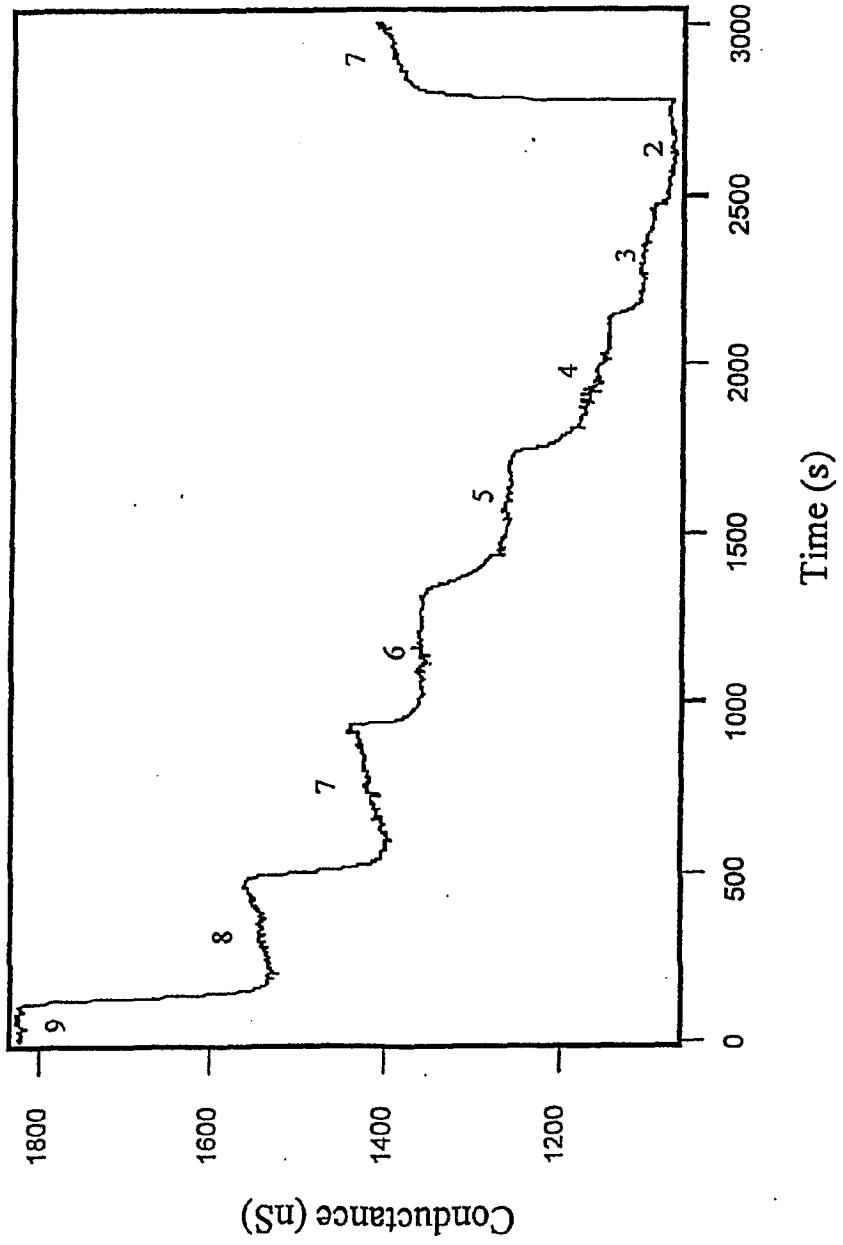

Fig 9b

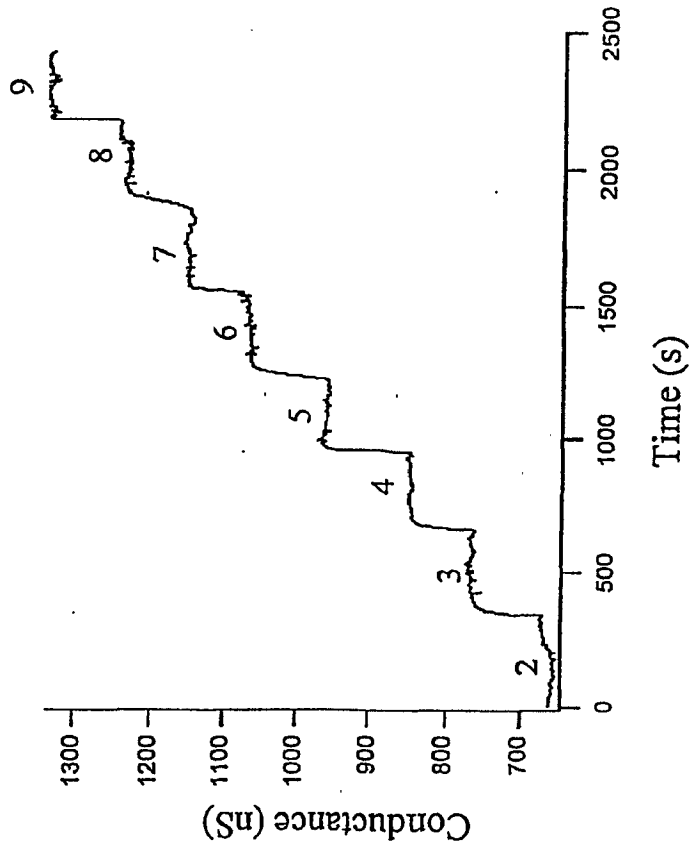

Fig. 9c

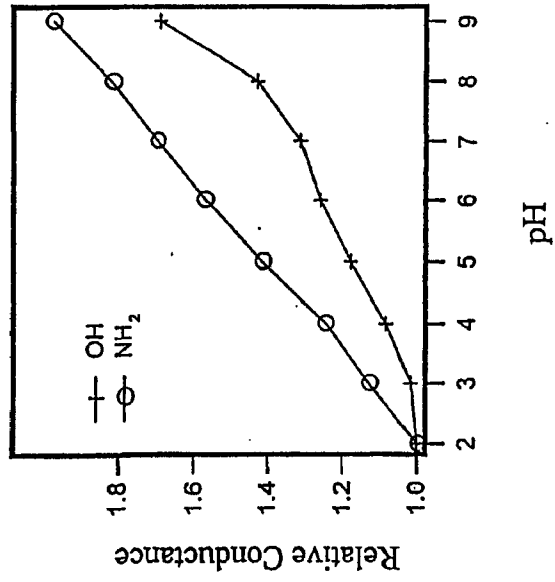

Fig. 10a

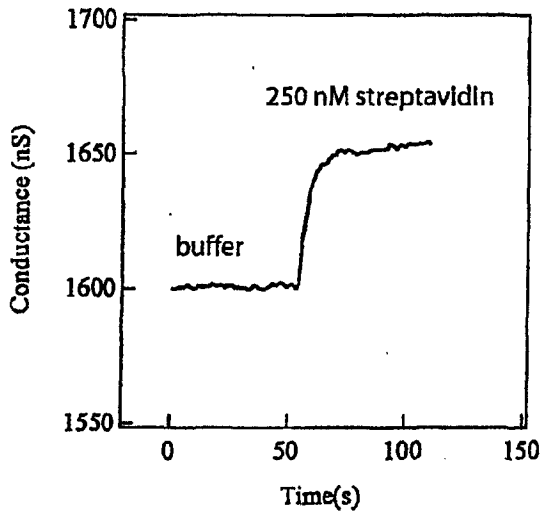

Fig. 10b.

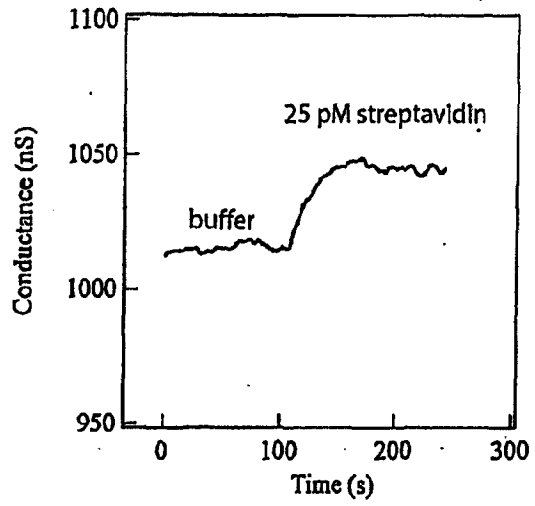

Fig 10c

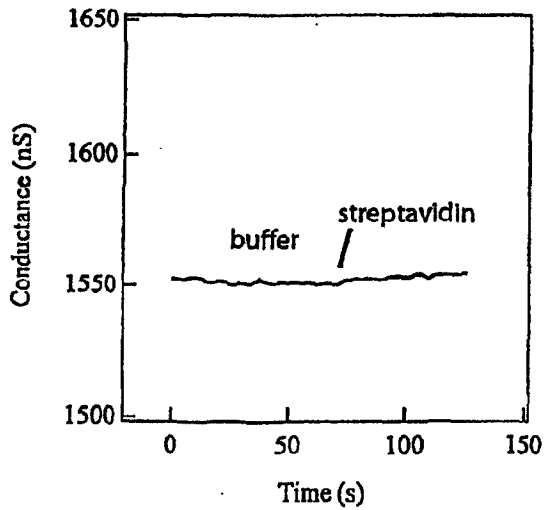
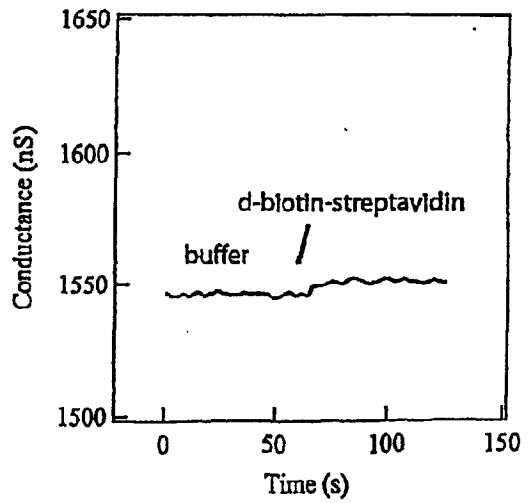

Fig. 10d



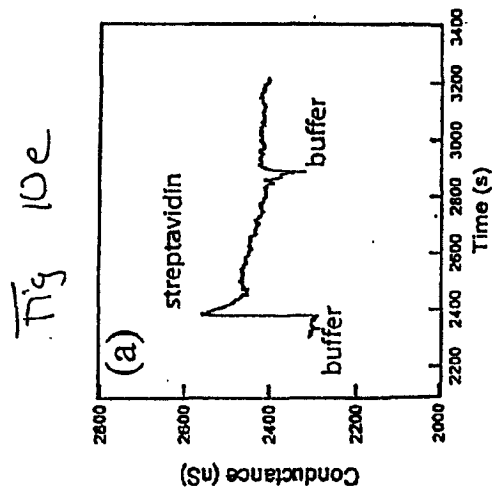
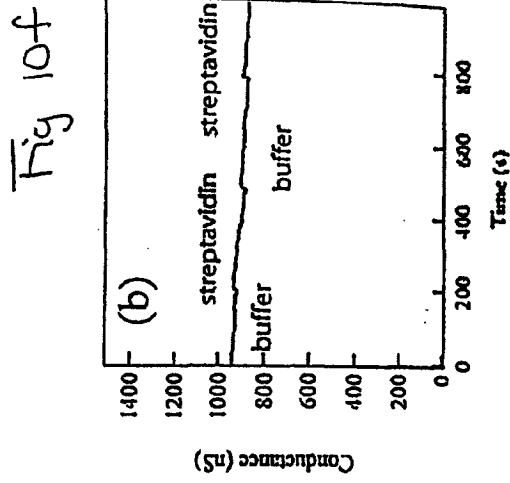

Fig 11a

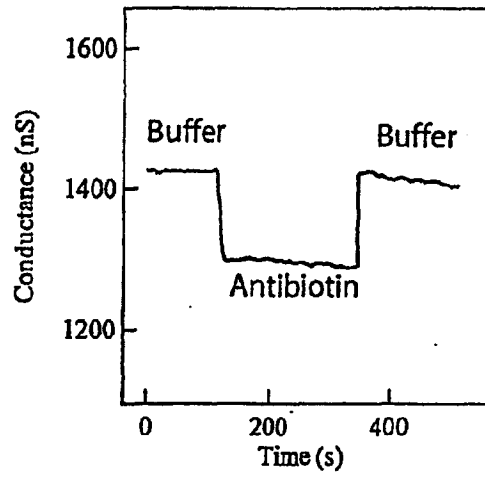

Fig 11b

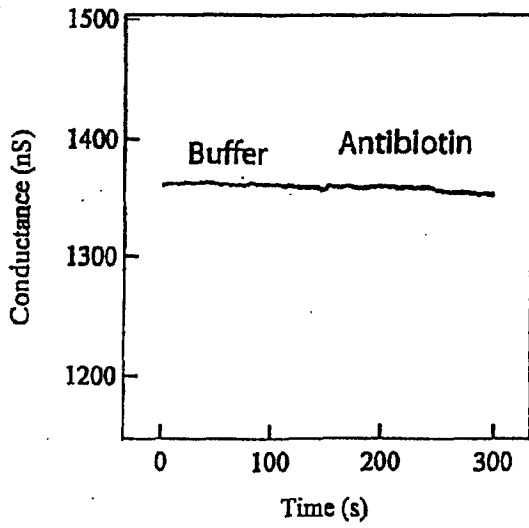

Fig 11c

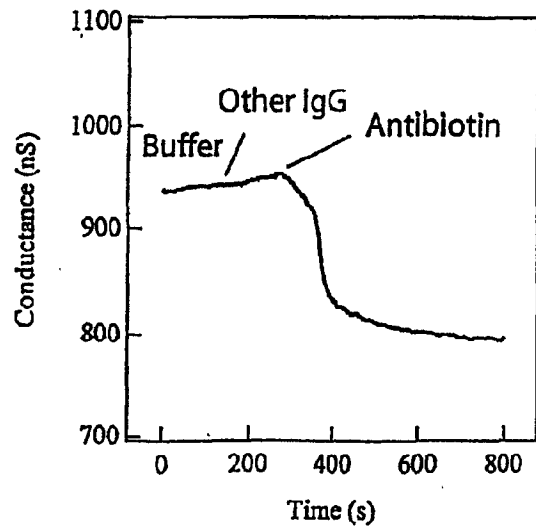

Fig 12a

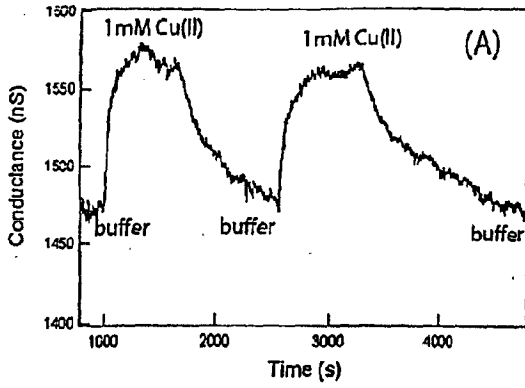

Fig 12b

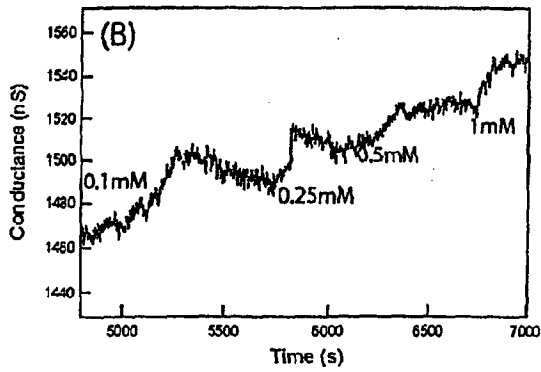

Fig 12c

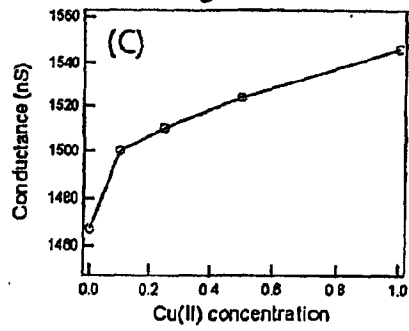

Fig 12d

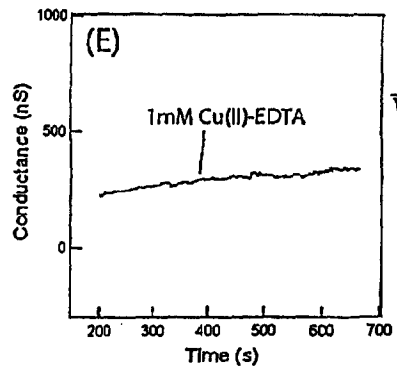
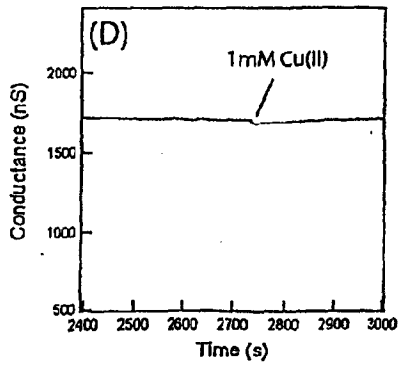

Fig 12e

Fig 13a

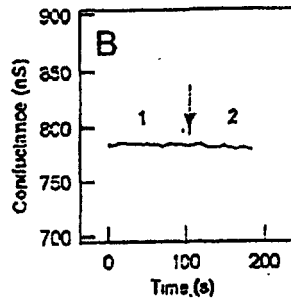
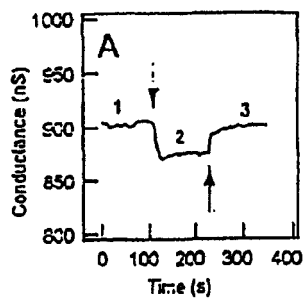

Fig 13b

Sensitivity dependent on doping and size of nanowires

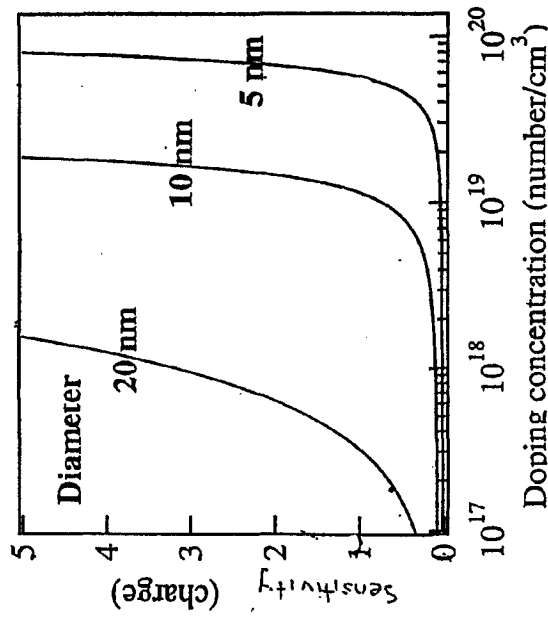

Fig 14a

Threshold doping density for single charge detection

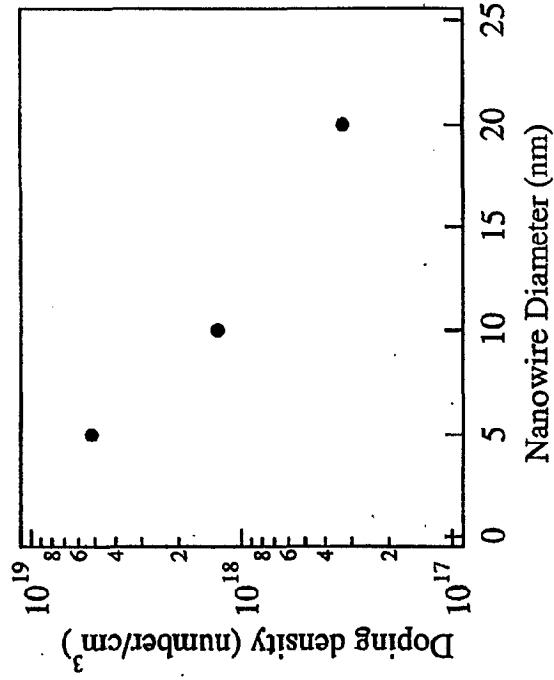

Fig 14b

InP pH Sensor

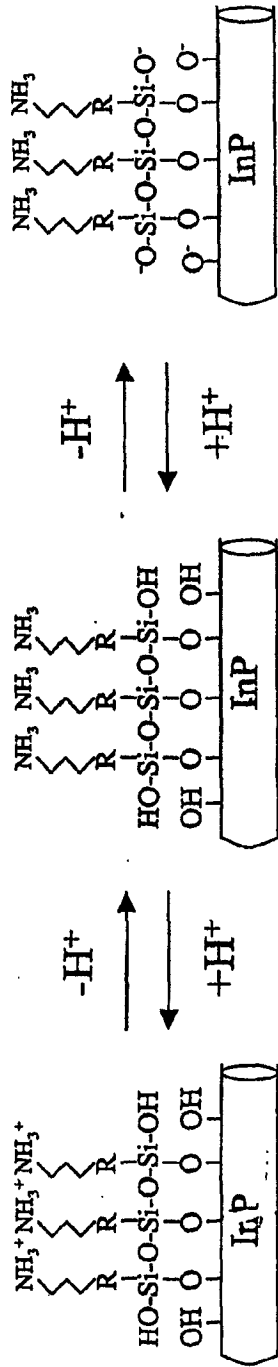

Fig 15a

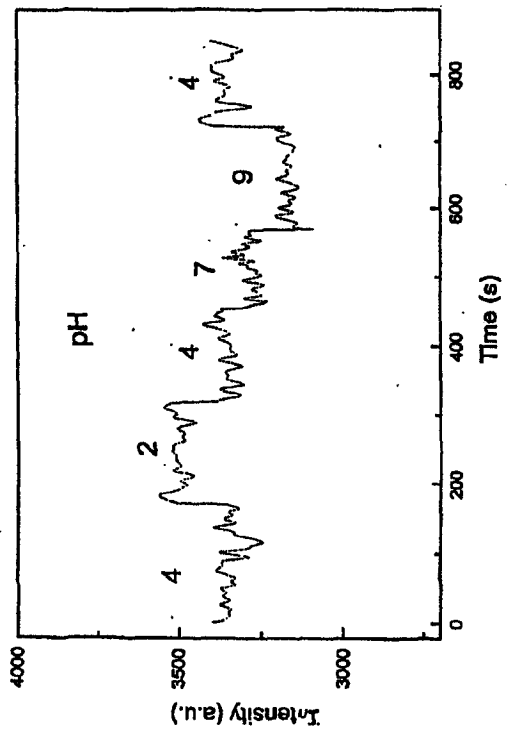

Fig 15b

Fig. 16a

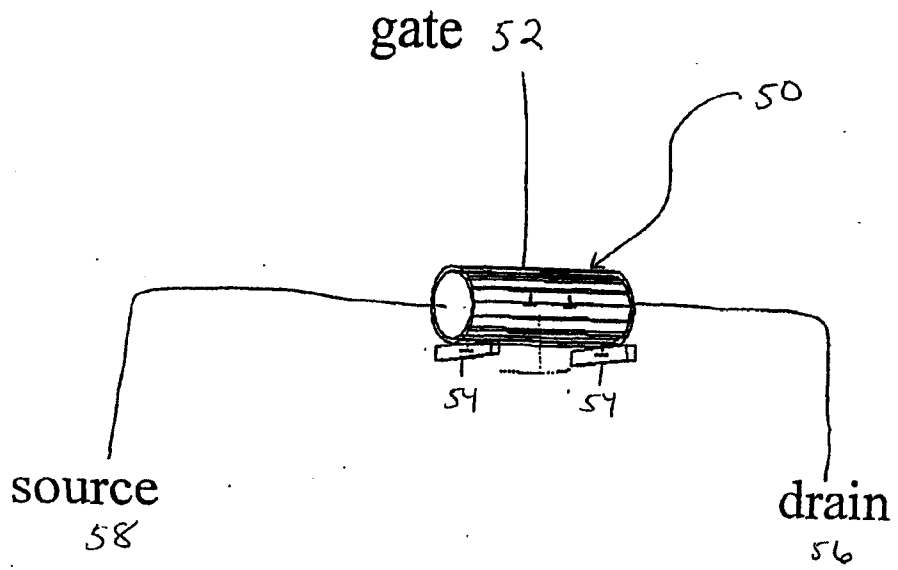

Fig. 16 b

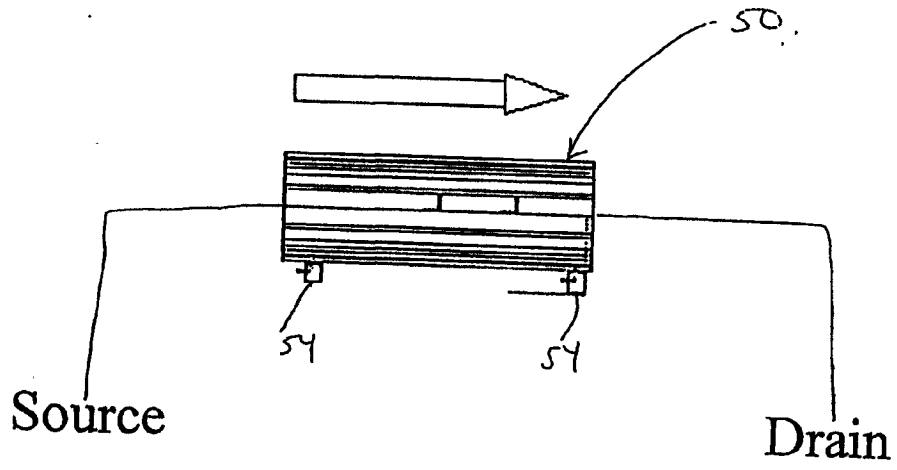

Fig. 16 c

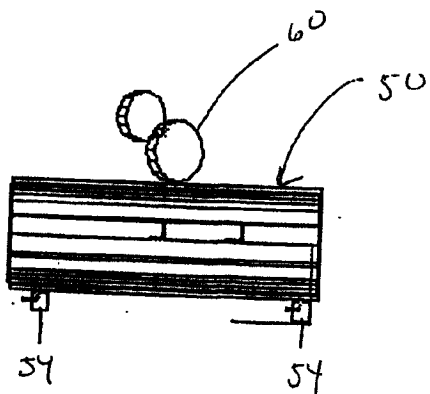
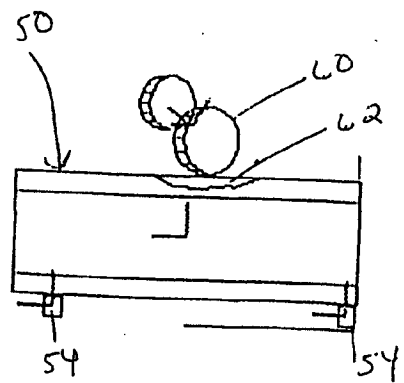

Fig. 16 d



REFERENCES CITED IN THE DESCRIPTION

This list of references cited by the applicant is for the reader's convenience only. It does not form part of the European patent document. Even though great care has been taken in compiling the references, errors or omissions cannot be excluded and the EPO disclaims all liability in this regard.

Patent documents cited in the description

- US 292035 P [0002]
- US 60254745 B [0002]
- US 5644048 A [0032]
- US 5386023 A [0032]
- US 5637684 A [0032]
- US 5602240 A [0032]
- US 5216141 A [0032]
- US 4469863 A [0032]
- US 5235033 A [0032]
- US 5034506 A [0032]
- US 9610287 W [0034]
- WO 9629629 A [0071] [0073]
- US 5512131 A [0071]
- WO 9734025 A, Hidber [0074]
- US 3873359 A [0074]
- US 3873360 A [0074]
- US 3900614 A [0074]
- WO 0103208 A, Lieber [0074]
- WO 9733737 A [0078]

Non-patent literature cited in the description

- **BEUCAGE et al.** *Tetrahedron*, 1993, vol. 49 (10), 1925 [0032]
- **LETSINGER.** *J. Org. Chem.*, 1970, vol. 35, 3800 [0032]
- **SPRINZL et al.** *Eur. J. Biochem.*, 1977, vol. 81, 579 [0032]
- **LETSINGER et al.** *Nucl. Acids Res.*, 1986, vol. 14, 3487 [0032]
- **SAWAI et al.** *Chem. Lett.*, 1984, 805 [0032]
- **LETSINGER et al.** *J. Am. Chem. Soc.*, 1988, vol. 110, 4470 [0032] [0032]
- **PAUWELS et al.** *Chemica Scripta*, 1986, vol. 26, 1419 [0032]
- **MAG et al.** *Nucleic Acids Res.*, 1991, vol. 19, 1437 [0032]
- **BRIU et al.** *J. Am. Chem. Soc.*, 1989, vol. 111, 2321 [0032]
- **EGHOLM.** *J. Am. Chem. Soc.*, 1992, vol. 114, 1895 [0032]
- **MEIER et al.** *Chem. Int. Ed. Engl.*, 1992, vol. 31, 1008 [0032]
- **NIELSEN.** *Nature*, 1993, vol. 365, 566 [0032]
- **CARLSSON et al.** *Nature*, 1996, vol. 380, 207 [0032]
- **DENPCY et al.** *Proc. Natl. Acad. Sci. USA*, 1995, vol. 92, 6097 [0032]
- **ANGEW.** *Chem. Intl. Ed. English*, 1991, vol. 30, 423 [0032]
- **LETSINGER et al.** *Nucleoside & Nucleotide*, 1994, vol. 13, 1597 [0032]
- Carbohydrate Modifications in Antisense Research. ASC Symposium Series 580 [0032] [0032]
- **MESMAEKER et al.** *Bioorganic & Medicinal Chem. Lett.*, 1994, vol. 4, 395 [0032]
- **JEFFS et al.** *J. Biomolecular NMR*, 1994, vol. 34, 17 [0032]
- *Tetrahedron Lett.*, 1996, vol. 37, 743 [0032]
- **JENKINS et al.** *Chem. Soc. Rev.*, 1995, 169-176 [0032]
- **RAWLS, C & E.** *News*, 02 June 1997, 35 [0032]
- **VAUGHAN et al.** *Nature Biotechnology*, 1996, vol. 14 (3), 309-314 [0034]
- **THESS et al.** Crystalline Ropes of Metallic Carbon Nanotubes. *Science*, 1996, vol. 273, 483-486 [0040]
- **KONG et al.** Synthesis of Individual Single-Walled Carbon Nanotubes on Patterned Silicon Wafers. *Nature*, 1998, vol. 395, 878-881 [0041]
- **KONG et al.** Chemical Vapor Deposition of Methane for Single-Walled Carbon Nanotubes. *Chem. Phys. Lett.*, 1998, vol. 292, 567-574 [0041]
- **MORALES et al.** A Laser Ablation Method for the Synthesis of Crystalline Semiconductor Nanowires. *Science*, 1998, vol. 279, 208-211 [0041]
- **GRANGER.** Fluid Mechanics. Dover, 1995 [0085]
- **MEYER.** Introduction to Mathematical Fluid Dynamics. Dover, 1982 [0085]
- The Art of Electronics. Cambridge University Press, 1989, 113-174 [0104]

专利名称(译)	纳米传感器		
公开(公告)号	EP1736760A2	公开(公告)日	2006-12-27
申请号	EP2006121157	申请日	2001-12-11
[标]申请(专利权)人(译)	哈佛大学校长及研究员协会		
申请(专利权)人(译)	主席和哈佛学院院士		
当前申请(专利权)人(译)	主席和哈佛学院院士		
[标]发明人	LIEBER CHARLES PARK HONGKUN WEI QUINQIAO CUI YI LIANG WENJIE		
发明人	LIEBER, CHARLES PARK, HONGKUN WEI, QUINQIAO CUI, YI LIANG, WENJIE		
IPC分类号	G01N27/00 C30B29/60 H01L29/00 C30B25/00 C30B23/00 G01N33/53 H01L21/00 C30B11/00 C30B25/02 G01N27/12 G01N27/30 G01N27/327 G01N27/333 G01N27/414 G01N27/416 G01N27/42 G01N33/543 G01N33/566 G01N37/00 G11C13/02 H01L23/532 H01L29/06 H01L29/207 H01L29/267 H01L33/18 H01L51/30		
CPC分类号	G11C13/0019 B82Y10/00 B82Y15/00 C30B11/00 C30B25/005 C30B29/605 G01N27/127 G01N27/4146 G01N33/54373 G11C13/0014 G11C13/04 G11C2213/77 G11C2213/81 H01L23/53276 H01L29/0665 H01L29/0673 H01L29/16 H01L29/1602 H01L29/1606 H01L29/207 H01L29/267 H01L33/18 H01L51/0048 H01L2924/0002 H01L2924/12044 H01L2924/3011		
优先权	60/254745 2000-12-11 US 60/292035 2001-05-18 US		
其他公开文献	EP1736760A3		
外部链接	Espacenet		

摘要(译)

描述了由纳米线组成的电子器件及其制造和使用方法。纳米线可以是纳米管和纳米线。纳米线的表面可以选择性地官能化。描述了纳米探测器装置。

