



(11) **EP 1 683 496 B1**

(12) **EUROPEAN PATENT SPECIFICATION**

(45) Date of publication and mention of the grant of the patent:
10.12.2008 Bulletin 2008/50

(51) Int Cl.:
A61B 18/14 (2006.01)

(21) Application number: **06008779.8**

(22) Date of filing: **03.06.2003**

(54) **Laparoscopic bipolar electrosurgical instrument**

Bipolares Elektrochirurgisches Laparoskopieinstrument

Instrument électrochirurgical bipolaire laparoscopique

(84) Designated Contracting States:
DE ES FR GB IE IT

(30) Priority: **06.06.2002 US 164654**

(43) Date of publication of application:
26.07.2006 Bulletin 2006/30

(62) Document number(s) of the earlier application(s) in accordance with Art. 76 EPC:
03739020.0 / 1 513 464

(73) Proprietor: **Covidien AG**
8212 Neuhausen am Rheinfall (CH)

(72) Inventors:
• **Byusse, Steven P.**
Longmont, CO 80501 (US)
• **Lawes, Kate R.**
Lafayette, CO 80026 (US)

- **Schmaltz, Dale F.**
Fort Collins, CO 80524 (US)
- **Lands, Michael J.**
Louisville, CO 80027 (US)
- **Lukianow, S. Wade**
Nederland, CO 80466 (US)
- **Johnson, Kristin D.**
Louisville, CO 80027 (US)
- **Couture, Gary M.**
Longmont, CO 80501 (US)
- **Nguyen, Lap, P.**
Longmont, CO 80501 (US)

(74) Representative: **HOFFMANN EITLE**
Patent- und Rechtsanwälte
Arabellastrasse 4
81925 München (DE)

(56) References cited:
US-A- 5 196 009 **US-A- 5 391 166**
US-A- 6 039 733

EP 1 683 496 B1

Note: Within nine months of the publication of the mention of the grant of the European patent in the European Patent Bulletin, any person may give notice to the European Patent Office of opposition to that patent, in accordance with the Implementing Regulations. Notice of opposition shall not be deemed to have been filed until the opposition fee has been paid. (Art. 99(1) European Patent Convention).

Description

BACKGROUND

Field of the Invention

[0001] This disclosure relates to an electrosurgical instrument for performing laparoscopic surgical procedures, and more particularly to a laparoscopic electrosurgical instrument that is capable of grasping vessels and vascular tissue with sufficient force between two bipolar jaws to seal the vessel or vascular tissue.

Background of Related Art

[0002] Laparoscopic surgical instruments are used to perform surgical operation without making large incisions in the patient. The laparoscopic instruments are inserted into the patient through a cannula, or port, that has been made with a trocar. Typical sizes for cannulas range from three millimeters to twelve millimeters. Smaller cannulas are usually preferred, and this presents a design challenge to instrument manufacturers who must find ways to make surgical instruments that fit through the cannulas.

[0003] Certain surgical procedures require cutting blood vessels or vascular tissue. This sometimes presents a problem for surgeons because it is difficult to suture blood vessels using laparoscopic tools. Very small blood vessels, in the range below two millimeters in diameter, can often be closed using standard electrosurgical techniques. If a larger vessel is severed, it may be necessary for the surgeon to convert the laparoscopic procedure into an open-surgical procedure and thereby abandon the benefits of laparoscopy.

[0004] Several journal articles have disclosed methods for sealing small blood vessels using electrosurgery. An article entitled Studies on Coagulation and the Development of an Automatic Computerized Bipolar Coagulator, J. Neurosura.. Volume 75, Jul. 1991, describes a bipolar coagulator which is used to seal small blood vessels. The article states that it was not possible to safely coagulate arteries with a diameter larger than 2 to 2.5 mm. A second article is entitled Automatically Controlled Bipolar Electrocoagulation-"COA-COMP", Neurosurg. Rev. (1984), pp. 187-190. This article describes a method for terminating electrosurgical power to the vessel so that charring of the vessel walls can be avoided.

[0005] It has been recently determined that electrosurgical methods may be able to seal larger vessels using an appropriate electrosurgical power curve, coupled with an instrument capable of applying a large closure force to the vessel walls. It is thought that the process of coagulating small vessels is fundamentally different than electrosurgical vessel sealing. Coagulation is defined as a process of desiccating tissue wherein the tissue cells are ruptured and dried. Vessel sealing is defined as the process of liquefying the collagen in the tissue so that it

cross-links and reforms into a fused mass. Thus, coagulation of small vessels is sufficient to permanently close them. Larger vessels need to be sealed to assure permanent closure.

5 [0006] It would be desirable to have a surgical tool capable of applying electrosurgical energy, capable of applying a large closure force to the vessel walls, and also capable of fitting through a cannula. A large closure force between the jaws typically requires a large moment about the pivot for each jaw. This presents a challenge because the first and second pins have a small moment arm with respect to the pivot of each jaw. A large force, coupled with a small moment arm, is undesirable because the large forces may shear the first and second pins. It is also undesirable to increase the moment arm of the first and second pins because the physical size of the yoke might not fit through a cannula.

10 [0007] Several bipolar laparoscopic instruments are known. For example, U.S. Pat. No. 3,938,527 discloses a bipolar laparoscopic instrument for tubal cauterization. U.S. Pat. No. 5,250,047 discloses a bipolar laparoscopic instrument with a replaceable electrode tip assembly. U.S. Pat. No. 5,445,638 discloses a bipolar coagulation and cutting forceps with first and second conductors extending from the distal end. U.S. Pat. No. 5,391,166 discloses a bipolar endoscopic instrument having a detachable working end. U.S. Pat. No. 5,342,359 discloses a bipolar coagulation device.

15 [0008] The present invention solves the problem of providing a large closure force between the jaws of a laparoscopic bipolar electrosurgical instrument, using a compact design that fits through a cannula, without risking structural failure of the instrument yoke.

35 SUMMARY OF THE INVENTION

[0009] The present disclosure relates to a laparoscopic bipolar electrosurgical instrument for sealing tissue and includes a handle having an elongated tube affixed thereto. The tube includes first and second jaw members attached to a distal end thereof which are movable from a first position for approximating tissue to at least one subsequent position for grasping tissue therebetween. Each of the jaw members includes an electrically conductive sealing surface. The handle has a fixed handle and a handle which is movable relative to the fixed handle to effect movement of the jaw members from the first position to the at least one subsequent position for grasping tissue. The jaw members are connected to a source of electrosurgical energy such that the jaw members are capable of conducting bipolar electrosurgical energy through the tissue held therebetween. A stop is included for maintaining a minimum separation distance between opposing sealing surfaces of at least about 0.03 millimeters and a ratchet is included for maintaining a closure force in the range of about 3 kg/cm² to about 16 kg/cm² between opposing sealing surfaces. As can be appreciated, the stop member advantageously creates a mini-

mum separation between electrically conductive opposing sealing surfaces to effect an efficient, consistent and uniform tissue seal.

[0010] Advantageously, the stop maintains a minimum separation distance of about 0.03 millimeters to about 0.16 millimeters. The stop may be disposed on at least one of the electrically conductive sealing surfaces, or alternatively, the stop may be located adjacent one of the electrically conductive sealing surfaces. Although it is preferable to locate the stop member on one or both of the electrically conductive opposing sealing surfaces, it may in some instances be advantageous to locate the stop member adjacent the opposing sealing surfaces.

[0011] In one embodiment according to the present disclosure, the first jaw member is connected to the bipolar electrosurgical energy source by a pushrod and the second jaw member is connected to the bipolar electrosurgical source by a conductive tube. As can be appreciated, isolating the jaw members in this manner reduces the likelihood of the instrument short circuiting during activation.

[0012] In another embodiment, the ratchet is disposed within the fixed handle and at least one complimentary interlocking mechanical interface is disposed on the movable handle. Preferably, the ratchet and the complimentary interlocking mechanical interface provide at least one interlocking position for maintaining a closure force within the range of about 7 kg/cm² to about 13 kg/cm² between opposing sealing surfaces. Ideally, the closure force is in the range of about 4 kg/cm² to about 6.5 kg/cm². As can be appreciated and as mentioned herein, maintaining the closure force within the above working ranges is a key factor in producing an effective and consistent seal,

[0013] In yet another embodiment according to the present disclosure, the laparoscopic bipolar electrosurgical instrument includes a handle having an elongated tube affixed thereto with first and second jaw members attached to a distal end thereof which each include electrically conductive sealing surfaces. The jaw members are movable from a first position for approximating tissue to at least one subsequent position for grasping tissue therebetween. The handle has a fixed handle and a handle which is movable relative to the fixed handle to effect movement of the jaw members from the first position to at least one subsequent position for grasping tissue. Advantageously, the sealing surfaces include a non-stick material for reducing tissue adhesion during the sealing process. The first and second jaw members are coupled to a source of bipolar electrosurgical energy and a stop is disposed on at least one of the electrically conductive sealing surfaces to maintain a minimum separation distance between the opposable seal surfaces during sealing.

[0014] A ratchet is disposed on one of the fixed and movable handles and at least one complimentary interlocking mechanical interface is disposed on the other of the fixed and movable handles. Advantageously, the

ratchet and the complimentary interlocking mechanical interface include at least one interlocking position which maintains a closure force in the range of about 7 kg/cm² to about 13 kg/cm² between opposable seal surfaces.

[0015] In one embodiment, the non-stick material is a coating which is deposited on the opposable sealing surfaces. As can be appreciated, this reduces the likelihood of coagulum build-up and sticking. The non-stick coating may be selected from a group of materials consisting of: nitrides and nickel/chrome alloys. Preferably, the non-stick coating includes one of: TiN; ZrN; TiAlN; CrN; nickel/chrome alloys with a Ni/Cr ratio of approximately 5:1; Inconel 600; Ni200; and Ni201.

[0016] In one embodiment according to the present disclosure, the opposable sealing surfaces are manufactured from a non-stick material which is a nickel/chrome alloy. For example, the non-stick material may include nickel/chrome alloys with a Ni/Cr ratio of approximately 5:1, Inconel 600, Ni200 and Ni201. It is envisioned that these particular materials are advantageous in providing a superior non-stick surface which reduces coagulum build-up and sticking during activation.

[0017] Preferably, at least one of the jaw members, handles and elongated tube includes an insulative material disposed thereon which may advantageously be an insulative coating or an insulative sheath.

BRIEF DESCRIPTION OF THE DRAWINGS

[0018]

FIG. 1 is a perspective view of a laparoscopic bipolar electrosurgical instrument according to the present disclosure;

FIG. 2 is a perspective view of the distal end and jaws of the instrument in FIG. 1;

FIG. 3 is an exploded view of the distal end shown in FIG. 2;

FIG. 4 is perspective view of the distal end of the instrument with the jaws removed;

FIG. 5 is another perspective of FIG. 4;

FIG. 6 is a side view of an electrical spring contact; and

FIG. 7 is a front view of the spring contact shown in FIG. 6.

DETAILED DESCRIPTION OF THE INVENTION

[0019] A laparoscopic bipolar electrosurgical instrument 10 is shown in FIG. 1. The instrument 10 has a proximal end 11 with a handle 14 for holding and manipulating the instrument 10, A distal end 12 on the instru-

ment 10 is used for surgical manipulation of tissue. The instrument 10 comprises an elongate tube 13 that is sized to fit through a cannula for laparoscopic operations, and in different embodiments may be sized to fit through a five to ten millimeter cannulas.

[0020] A portion of the distal end 12 of the instrument 10 is shown in FIG. 2. A first jaw 15 and a second jaw 16 are shown in an open position. An angle α is subtended by the jaws 15 and 16. Closing of the jaws 15 and 16 is defined as a reduction of the angle α subtended by the jaws 15 and 16. Similarly, opening of the jaw 15 and 16 is defined as an enlargement of the angle α . The angle α is zero when the jaws 15 and 16 are closed together. The center of rotation for the first jaws 15 is at the first pivot 41, and the center of rotation for the second jaw 16 is at the second pivot 42. The first pivot 41 is located on an outer nose piece 32, and fits in a first pivot hole 43 located on the first flange 18. The second pivot 42 is located on an inner nose piece 31, and fits in a second pivot hole 44 located on the second flange 20.

[0021] Pieces that comprise the distal end 12 of the instrument 10 are shown in an exploded view in FIG. 3. The first jaw 15 and the second jaw 16 are shown separated from a yoke 17. The first jaw 15 has a first flange 18 and a first slot 19 therewithin. The second jaw 16 has a second flange 20 and a second slot 21 therewithin. Each jaw 15 and 16 is preferably formed from a single piece of stainless steel or other electrically conductive material.

[0022] Referring again to FIG. 3, the yoke 17 is attached to a pushrod 22. The yoke 17 is preferably formed from an electrically insulative material such as plastic. A first side 23 of the yoke 17 faces the first flange 18. A second side 24 of the yoke 17 faces the second flange 20. When the yoke 17 is positioned between the flanges 18 and 20, the yoke 17 also acts to electrically insulate the first jaw 15 from the second jaw 16. In this manner, bipolar electrosurgical current can be conducted through tissue grasped by the jaws 15 and 16 without short circuiting between the flanges 18 and 20.

[0023] A first pin 25 is located on the first side 23 which movably engages the first slot 19. Similarly, a second pin 26 is located on the second side 24 to movably engage the second slot 21. Each pin and slot combination works as a cam-follower mechanical linkage. Motion of the pushrod 22 moves the yoke 17 causing pins 25 and 26 to slide within their respective slots 19 and 21. The slots 19 and 21 are angled with respect to the distal ends of the jaws 15 and 16 such that the jaws 15 and 16 move in an arcuate fashion toward and away from each other. The pins 25 and 26 are different from the pivots 41 and 42. The pins 25 and 26 provide a force against the walls of the slots 19 and 21, creating a moment about the pivots 41 and 42.

[0024] The slots 19 and 21 are arranged such that distal motion of the pushrod 22 causes the jaws 15 and 16 to move together. Distal motion of the pushrod 22 is defined as motion in the direction of the distal end 12 of the

instrument 10. Once the jaws 15 and 16 are closed together, the present invention holds the jaws 15 and 16 together with a compressive force on the pushrod 22.

[0025] One of the advantages of this Invention is that shear forces on the pins 25 and 26 can be offloaded to prevent mechanical failure when large forces are being transmitted to the jaws 15 and 16. Each slot 19 and 20 has a cul-de-sac 27 and 28, respectively, as shown in FIG. 3. The first cul-de-sac 27 is an enlargement of the first slot 19 near its distal end. The second cul-de-sac 28 is an enlargement of the second slot 21 near its distal end. The cam-follower motion of the pins 25 and 26 in the slots 19 and 21 will bring the pins 25 and 26 into their respective cul-de-sac 27 and 28. This position of the pins 25 and 26 leaves a very small moment arm between the pins 25 and 26 and the pivots 41 and 42. The yoke 17 has shoulders 29 and 30 that can provide a relatively large moment about the pivots 41 and 42 to effect a high closure force between the jaws 15 and 16 without a high shear forces on the pins 25 and 26, as described below.

[0026] Once the pins 25 and 26 are in the cul-de-sacs 27 and 28, the force from the yoke is transmitted to the flanges 18 and 20 by a first shoulder 29 and a second shoulder 30. The shoulders 29 and 30 abut the proximal end of the flanges 18 and 20 to cause the jaws 15 and 16 to close together. The pivots 41 and 42 are preferably made of metal and can withstand relatively high shear forces. In contrast, pins 25 and 26 are preferably made of plastic and will break under relatively high shear forces. Thus, the shoulders 29 and 30 provide a moment about the pivots 41 and 42, thereby avoiding the necessity of applying high shear forces to the pins 25 and 26 wherein the moment arm from the pins 25 and 26 would be small. There is an angle α at which the pins 25 and 26 enter their respective cul-de-sacs 27 and 28 and the shoulders 29 and 30 abut the flanges 18 and 20. The angle α at which the forgoing occurs is preferably around three degrees.

[0027] The bipolar electrosurgical instrument 10 has first and second poles of alternating potential that are conducted along the instrument 10 and through tissue that is grasped between the jaws 15 and 16. The first pole is conducted from the proximal end 11 toward the distal end 12 along the pushrod 22. The second pole is conducted from the proximal end 11 toward the distal end 12 along the tube 13. The outer surface of the tube 13 is preferably coated with an electrically insulative material. There is also preferably an electrically insulative barrier between the pushrod 22 and the tube 13 to prevent short circuits in the instrument 10.

[0028] In the preferred embodiment, the distal end of the instrument 10 comprises an inner nose piece 31 and an outer nose piece 32, as shown in FIG. 2. The inner nose piece 31 is electrically connected with the pushrod 22, while the outer nose piece is electrically connected with the tube 13. The inner nose piece 31 and the outer nose piece 32 capture the yoke 17, along with the first and second flanges 18 and 20, as shown in FIG. 2. The

yoke 17 moves axially, along an axis defined by the tube 13, in a space between the inner and outer nose pieces 31 and 32. A spacer stake 33 maintains the separation of the nose pieces 31 and 32 at their distal ends. The nose pieces 31 and 32 provide lateral support for the flanges 18 and 20 to help ensure that the pins 25 and 26 remain within the slots 18 and 21, respectively.

[0029] The preferred embodiment also comprises an inner insulator 34 and an outer insulator 35 for maintaining electrical insulation between the poles. The outer insulator 35 is seated between the tube 13 and the inner nose 31, as shown in FIGS. 2 and 4. The inner insulator 34 is seated between the tube 13 and the pushrod 22. In this manner, the outer nose piece 32 can provide electrical continuity between the tube 13 and the second jaw 16, while the inner nose piece 34 can provide electrical continuity between the pushrod 22 and the first jaw 15. Since the pushrod 22 is slidably mounted within the tube 13, the preferred embodiment has a spring contact 36, as shown in FIGS. 6 and 7, which is mounted on the pushrod 22 to maintain an electrical connection with the inner nose piece 34 during axial motion.

[0030] The first and second jaws 15 and 16 each have ridges 37 and 38 at their distal ends that preferably nest together. The jaws 15 and 16 also have seal surfaces 39 and 40, as shown in FIG. 2. The width of the seal surfaces 39 and 40 is a parameter that affects the quality of the surgical outcome. The closure force between the jaws 15 and 16 varies along the length of the seal surfaces 39 and 40, with the largest force at the distal tip and the smallest force at the proximal end of the seal surfaces 39 and 40. It is known that the amount of pressure exerted on the tissue depends on the surface area of the tissue that is in contact with the seal surfaces. In the one embodiment, the width of each seal surface, e.g., 39, is in the range of about 2 to about 5 millimeters, and preferably 4 millimeters width, while the length of each seal surface 39 and 40 is preferably in the range of about 10 to 30 millimeters.

[0031] It has been found through experimentation that good vessel sealing results are obtained when the closure force in grams divided by the width in millimeters is in the range of about 400 to 650 grams per millimeter of seal surface width. Since the closure force varies with the length of the seal surfaces 39 and 40, it has been found to be advantageous to taper the width of the seal surfaces 39 and 40 along their length, with the widest width at the proximal end and the narrowest width at the distal end. For example, if the width of the seal surface 39, 40 is 4 millimeters, the closure force is preferably in the range of about 1600 grams to about 2600 grams. This design allows the jaws 15 and 16 to apply a relatively constant closure force per unit width, preferably 525 grams per millimeter width which yields a closure force of 2100 grams for a 4 millimeter width seal surface 39, 40.

[0032] In one embodiment, the handle 14 includes a fixed handle 50 having a channel 51 defined therein which slidably receives a movable handle 52. Movable

handle 52 includes a handgrip 53 defined therein which allows a user to move handle 52 relative to fixed handle 50. Movable handle 52 also includes a flange 55 having a series of grooves 62 defined therein which mechanically inter-engage a corresponding ratchet 60 disposed within channel 51. Preferably, the ratchet 60 and groove 62 are dimensioned such that successive ratchet positions will yield pressures within a predetermined working range of about 7 kg/cm² to about 13 kg/cm². In one embodiment, the successive ratchet positions are two millimeters apart.

[0033] Experimental results in tissue studies suggest that the magnitude of pressure exerted on the tissue by the seal surfaces 39 and 40 is important in assuring a proper surgical outcome. Tissue pressures within a working range of about 3 kg/cm² to about 16 kg/cm² and, preferably, within a working range of 7 kg/cm² to 13 kg/cm² have been shown to be effective for sealing arteries and vascular bundles. Tissue pressures within the range of about 4 kg/cm² to about 6.5 kg/cm² have proven to be particularly effective in sealing arteries and tissue bundles.

[0034] A method of making a laparoscopic bipolar electrosurgical instrument 10 is also herein described. The method comprises the step of forming a first jaw 15 having a first flange 18 with a first slot 19, and a second jaw 16 having a second flange 20 with a second slot 21. The jaws 15 and 16 are preferably formed in a casting process, although it is also possible to machine the jaws 15 and 16 from stock. The casting process may include injecting powdered metal under pressure into a mold, and then applying heat.

[0035] Other steps in the method include attaching a yoke 17 to a pushrod 22, and electrically insulating the first flange 18 from the second flange 20 with the yoke 17. The yoke 17 is preferably an injection molded plastic part with features including a first shoulder 29 and a second shoulder 30.

[0036] During assembly of the distal portion of the instrument 10, steps in the method include engaging a first pin 25 with the first slot 19, and engaging a second pin 26 with the second slot 21. The slots 19 and 21 are shaped such that a subtended angle α between the first and second jaws 15 and 16 decreases with distal motion of the pushrod 17. The slots 19 and 20 are formed with cul-de-sacs 27 and 28 positioned to relieve shear stresses on the first and second pins 25 and 26 at the subtended angle α approximately where the first and second shoulders 29 and 30 engage the first and second flanges 18 and 20.

[0037] Further steps in the method comprise: surrounding at least a portion of the pushrod 22 with an electrically conductive tube 13; electrically insulating the tube 13 from the pushrod 22; electrically connecting an inner nose piece 31 to the pushrod 22, and electrically connecting an outer nose piece 32 to the tube 13, wherein the inner nose piece 31 and the outer nose piece 32 capture the yoke 17 along with the first and second flang-

es 18 and 20 to conduct bipolar electrosurgical current to the first and second jaws 15 and 16. In the preferred embodiment, there is a step of electrically connecting the pushrod 22 and the inner nose piece 31 with a spring contact 36.

[0038] The method of making the instrument 10, in some embodiments, includes the steps of tapering the width of the seal surfaces 39 and 40 along the length of each of the first and second jaws 15 and 16.

[0039] An electrically insulative coating 70 may be included to substantially cover the elongated tube 13 to protect the surgeon against electrical arcs. Other parts of the instrument may also be protected by the insulative coating 70. An insulative sheath may also be used to cover tube 13 or other components of the instrument 10, e.g., the proximal end 11, handles 50, 52 and the outer surfaces (non-opposing surfaces) of the jaw members 15, 16,

[0040] It is envisioned that the outer surface of the jaw members 15 and 16 may include a nickel-based material, coating, stamping, metal injection molding which is designed to reduce adhesion between the jaw members (or components thereof) with the surrounding tissue during activation and sealing. Moreover, it is also contemplated that other components such as the tube 13 and handles 50, 52 may also be coated with the same or a different "non-stick" material. Preferably, the non-stick materials are of a class of materials that provide a smooth surface to prevent mechanical tooth adhesions.

[0041] It is also contemplated that the tissue sealing surfaces 39 and 40 of the jaw members 15 and 16, respectively, may be manufactured from one (or a combination of one or more) of the following "non-stick" materials: nickelchrome, chromium nitride, MedCoat 2000 manufactured by The Electrolyzing Corporation of OHIO, Inconel 600 and tin-nickel. For example, high nickel chrome alloys and Ni200, Ni201 (~100% Ni) may be made into electrodes or sealing surfaces by metal injection molding, stamping, machining or any like process.

[0042] In addition these materials preferably include an optimal surface energy for eliminating sticking due in part to surface texture and susceptibility to surface breakdown due electrical effects and corrosion in the presence of biologic tissues. It is envisioned that these materials exhibit superior non-stick qualities over stainless steel and should be utilized on the instrument in areas where the exposure to pressure and RF energy can create localized "hot spots" more susceptible to tissue adhesion. As can be appreciated, reducing the amount that the tissue "sticks" during sealing improves the overall efficacy of the instrument.

[0043] The tissue sealing surfaces 39 and 40 may also be "coated" with one or more of the above materials to achieve the same result, i.e., a "non-stick surface". For example, Nitride coatings (or one or more of the other above-identified materials) may be deposited as a coating on another base material (metal or nonmetal) using a vapor deposition manufacturing technique.

[0044] One particular class of materials disclosed herein has demonstrated superior non-stick properties and, in some instances, superior seal quality. For example, nitride coatings which include, but are not limited to: TiN, ZrN, TiAlN, and CrN are preferred materials used for non-stick purposes. CrN has been found to be particularly useful for non-stick purposes due to its overall surface properties and performance. Other classes of materials have also been found to reducing overall sticking, For example, high nickel/chrome alloys with a Ni/Cr ratio of approximately 5:1 have been found to significantly reduce sticking in bipolar instrumentation. One particularly useful non-stick material in this class is Inconel 600. Bipolar instrumentation having electrodes made from or coated with Ni200, Ni201 (~100% Ni) also showed improved non-stick performance over typical bipolar stainless steel electrodes.

[0045] It has been found experimentally that local current concentrations can result in an uneven tissue effect, and to reduce the possibility of this outcome, each seal surface 39 and 40 may include a radiused edge 80, 81. As mentioned above, a tapered seal surface 39 and 40 has been shown to be advantageous in certain embodiments because the taper allows for a relatively constant pressure on the tissue along the length of the seal surfaces 39 and 40. The width of the seal surfaces 39 and 40 may be adjusted to assure that the closure force divided by the width is approximately constant along the length.

[0046] In one embodiment, a stop 90, made from insulative material, is located in the instrument to maintain a minimum separation of at least about 0.03 millimeters between the seal surfaces 39 and 40, as shown in FIG. 3. Preferably, the stop maintains a minimum separation distance in the range of about 0.03 millimeters to about 0.16 millimeters. The stop 90 reduces the possibility of short circuits between the seal surfaces 39 and 40. It is envisioned that stop 90 may be positioned proximate the pivots 41 and 42, proximate the stake 33 or adjacent the opposable seal surfaces 39 and 40.

[0047] In another embodiment, the instrument 10 includes a second or alternative stop 95 which is designed to maintain a minimum separation of at least about 0.03 millimeters between the seal surfaces 39 and 40, as shown in FIG. 2. Preferably, the stop 90 and/or the stop 95 maintains a separation distance within the range of about 0.03 millimeters to about 0.16 millimeters. A plurality of stops 90 and/or 95 (or various patterns of stops 90, 95) may also be utilized to accomplish this purpose.

[0048] The following numbered paragraphs reveal further aspects of the invention.

Paragraphs

[0049]

1. A laparoscopic bipolar electrosurgical instrument for sealing tissue, comprising:

a handle having an elongated tube affixed thereto, the tube including first and second jaw members attached to a distal end thereof, the jaw members being movable from a first position for approximating tissue to at least one subsequent position for grasping tissue therebetween each of the jaw members including an electrically conductive sealing surface, the handle including a fixed handle and a movable handle, the movable handle being movable relative to the fixed handle to effect movement of the jaw members from the first position to the at least one subsequent position for grasping tissue;

means for connecting the jaw members to a source of electrocautery energy such that the opposable seal surfaces are capable of conducting electrocautery energy through tissue held therebetween;

a stop for maintaining a minimum separation distance of at least about 0.03 millimeters between opposable sealing surfaces; and

means for maintaining a closure force in the range of about 3 kg/cm² to about 16 kg/cm² between opposable sealing surfaces.

2. A laparoscopic bipolar electrocautery instrument as in paragraph 1, wherein the connecting means includes:

a pushrod for connecting the first jaw member to a source of electrocautery energy; and

a conductive tube for connecting the second jaw member to the source of electrocautery energy.

3. A laparoscopic bipolar electrocautery instrument as in paragraph 1 or 2, wherein the maintaining means includes a ratchet disposed within the fixed handle and at least one complementary interlocking mechanical interface disposed on the movable handle, the ratchet and the complementary interlocking mechanical interface providing at least one interlocking position for maintaining a closure force within the range of about 7 kg/cm² to about 13 kg/cm² between opposable sealing surfaces.

4. A laparoscopic bipolar electrocautery instrument as in any one of the preceding paragraphs, wherein the closure force is in the range of about 4 kg/cm² to about 6.5 kg/cm².

5. A laparoscopic bipolar electrocautery instrument as in any one of the preceding paragraphs, wherein the stop is disposed on at least one of the sealing surfaces.

6. A laparoscopic bipolar electrocautery instrument as in any one of the preceding paragraphs, wherein

the stop is disposed adjacent to at least one of the sealing surfaces.

7. A laparoscopic bipolar electrocautery instrument as in any one of the preceding paragraphs, wherein the stop maintains a minimum separation distance between sealing surfaces in the range of about 0.03 millimeters to about 0.16 millimeters.

Claims

1. A laparoscopic bipolar electrocautery instrument (10) for sealing tissue, comprising:

a handle (14) having an elongated tube (13) affixed thereto, the tube (13) including first and second jaw members (15, 16) attached to a distal end (12) thereof, the jaw members (15, 16) being movable from a first position for approximating tissue to at least one subsequent position for grasping tissue therebetween, each of the jaw members (15, 16) including an electrically conductive sealing surface, the handle (14) including a fixed handle (50) and a movable handle (52), the movable handle (52) being movable relative to the fixed handle (50) to effect movement of the jaw members (15, 16) from the first position to the at least one subsequent position for grasping tissue, the opposable sealing surfaces (39, 40) including a non-stick material for reducing tissue adhesion during the sealing process;

means for connecting the jaw members (15, 16) to a source of electrocautery energy such that the opposable sealing surfaces (39, 40) are capable of conducting electrocautery energy through tissue held therebetween; **characterized by**

a stop (90) disposed on one of the opposable sealing surfaces (39, 40) for maintaining a minimum separation distance of at least about 0.03 millimeters between the opposable sealing surfaces (39, 40); and

a ratchet (60) disposed on one of the fixed and movable handles (50, 52) and at least one complementary interlocking mechanical interface (55, 62) disposed on the other of the fixed and movable handles (50, 52) the ratchet (60) and the complementary interlocking mechanical interface (62) providing at least one interlocking position to maintain a closure force in the range of about 3 kg/cm² to about 16 kg/cm² between opposable sealing surface (39, 40).

2. A laparoscopic bipolar electrocautery instrument according to claim 1, wherein the non-stick material is a coating which is deposited on the opposable seal-

ing surfaces (39, 40).

3. A laparoscopic bipolar electrosurgical instrument according to claim 1 or 2, wherein the non-stick coating is selected from a group of materials consisting of: 5
nitrides and nickel/chrome alloys.
4. A laparoscopic bipolar electrosurgical instrument according to claim 3, wherein the non-stick coating includes at least one of: TiN; ZrN; TiAlN; CrN; nickel/ 10
chrome alloys with a Ni/Cr ratio of approximately 5:1; Inconel 600; Ni200; and Ni201.
5. A laparoscopic bipolar electrosurgical instrument according to claim 1, wherein the opposable sealing surfaces (39, 40) are manufactured from a non-stick material. 15
6. A laparoscopic bipolar electrosurgical instrument according to claim 5, wherein the non-stick material is a nickel/chrome alloy. 20
7. A laparoscopic bipolar electrosurgical instrument according to claim 6, wherein the non-stick material includes at least one of the nickel/chrome alloys with a Ni/Cr ratio of approximately 5:1, Inconel 600, Ni200 and Ni201. 25
8. A laparoscopic bipolar electrosurgical instrument according to any one of the preceding claims, wherein at least one of the jaw members (15, 16), handles (14) and elongated tube (13) includes an insulative material disposed thereon. 30
9. A laparoscopic bipolar electrosurgical instrument according to claim 8, wherein the insulative material is an insulative coating. 35
10. A bipolar electrosurgical instrument according to claim 8, wherein the insulative material is an insulative sheath. 40

Patentansprüche

1. Laparoskopisches bipolares elektrochirurgisches Instrument (10) zum Verschließen von Gewebe, mit:

einem Griff (14) mit einem länglichen daran befestigten Rohr (13), wobei das Rohr (13) erste und zweite Backenelemente (15, 16) umfasst, die an einem distalen Ende (12) davon angebracht sind, wobei die Backenelemente (15, 16) aus einer ersten Position zum Annähern von Gewebe in zumindest eine nachfolgende Position zum Ergreifen von Gewebe dazwischen bewegbar sind, wobei jedes der Backenelemente (15, 16) eine elektrisch leitfähige Verschlussoberflä-

che umfasst, wobei der Griff (14) einen festen Griff (50) und einen bewegbaren Griff (52) umfasst, wobei der bewegbare Griff (52) relativ zu dem festen Griff (50) bewegbar ist, um eine Bewegung der Backenelemente (15, 16) aus der ersten Position in die zumindest eine nachfolgende Position zum Ergreifen von Gewebe zu bewirken, wobei die gegenüberlegbaren Verschlussoberflächen (39, 40) ein Antihafmaterial umfassen, zum Verringern von Gewebeadhäsion während des Verschlussvorgangs; einem Mittel zum Verbinden der Backenelemente (15, 16) mit einer Quelle von elektrochirurgischer Energie, derart, dass die gegenüberlegbaren Verschlussoberflächen (39, 40) imstande sind, elektrochirurgische Energie durch dazwischen gehaltenes Gewebe zu leiten; **gekennzeichnet durch**

einen Anschlag (90), der an einer der gegenüberlegbaren Verschlussoberflächen (39, 40) angeordnet ist, zum Beibehalten eines minimalen Trennungsabstands von zumindest ungefähr 0,03 Millimeter zwischen den gegenüberlegbaren Verschlussoberflächen (39, 40); und eine Ratsche (60), die an einem der festen und bewegbaren Griffe (50, 52) angeordnet ist, und zumindest eine komplementäre mechanische Verriegelungsschnittstelle (55, 62), die an dem anderen der festen und bewegbaren Griffe (50, 52) angeordnet ist, wobei die Ratsche (60) und die komplementäre mechanische Verriegelungsschnittstelle (62) zumindest eine Verriegelungsposition vorsehen, um eine Schließkraft in dem Bereich von ungefähr 3 kg/cm² bis ungefähr 16 kg/cm² zwischen gegenüberlegbaren Verschlussoberflächen (39, 40) beizubehalten.

2. Laparoskopisches bipolares elektrochirurgisches Instrument nach Anspruch 1, wobei das Antihafmaterial eine Beschichtung ist, die auf den gegenüberlegbaren Verschlussoberflächen (39, 40) aufgebracht ist.

3. Laparoskopisches bipolares elektrochirurgisches Instrument nach Anspruch 1 oder 2, wobei die Antihafbeschichtung aus einer Gruppe von Materialien ausgewählt ist, die aus Nitriden und Nickel-/Chrom-Legierungen besteht. 45

4. Laparoskopisches bipolares elektrochirurgisches Instrument nach Anspruch 3, wobei die Antihafbeschichtung zumindest eines von TiN; ZrN; TiAlN; CrN; Nickel-/Chrom-Legierungen mit einem Ni/Cr-Verhältnis von ungefähr 5:1; Inconel 600; Ni200; und Ni201 umfasst. 55

5. Laparoskopisches bipolares elektrochirurgisches Instrument nach Anspruch 1, wobei die gegenüber-

legbaren Verschlussoberflächen (39, 40) aus einem Antihafmaterial hergestellt sind.

6. Laparoskopisches bipolares elektrochirurgisches Instrument nach Anspruch 5, wobei das Antihafmaterial eine Nickel-/Chrom-Legierung ist. 5
7. Laparoskopisches bipolares elektrochirurgisches Instrument nach Anspruch 6, wobei das Antihafmaterial zumindest eines der Nickel-/Chrom-Legierungen mit einem Ni/Cr-Verhältnis von ungefähr 5:1, Inconel 600, Ni200 und Ni201 umfasst. 10
8. Laparoskopisches bipolares elektrochirurgisches Instrument nach einem der vorhergehenden Ansprüche, wobei zumindest eines der Backenelemente (15, 16), Griffe (14) und länglichem Rohr (13) ein darauf angeordnetes, isolierendes Material umfasst. 15
9. Laparoskopisches bipolares elektrochirurgisches Instrument nach Anspruch 8, wobei das isolierende Material eine isolierende Beschichtung ist. 20
10. Laparoskopisches bipolares elektrochirurgisches Instrument nach Anspruch 8, wobei das isolierende Material eine isolierende Umhüllung ist. 25

Revendications

1. Instrument électrochirurgical bipolaire laparoscopique (10) pour le scellement de tissu, comprenant:

une poignée (14) présentant un tube oblong (13) fixé à celle-ci, le tube (13) ayant des premier et second éléments de mâchoire (15, 16) fixés à son extrémité distale (12), les éléments de mâchoire (15, 16) étant déplaçables d'une première position pour le rapprochement du tissu à au moins une position suivante pour la saisie du tissu entre eux, chacun des éléments de mâchoire (15, 16) incluant une surface de scellement électriquement conductrice, la poignée (14) incluant une poignée fixe (50) et une poignée mobile (52), la poignée mobile (52) étant déplaçable relativement à la poignée fixe (50) pour produire un mouvement des éléments de mâchoire (15, 16) de la première position à au moins une position suivante précitée pour saisir le tissu, les surfaces de scellement opposables (39, 40) incluant un matériau non-collant pour réduire l'adhésion du tissu pendant le processus de scellement;

un moyen pour relier les éléments de mâchoire (15, 16) à une source d'énergie électrochirurgicale de sorte que les surfaces de scellement opposables (39, 40) sont aptes à conduire l'énergie électrochirurgicale à travers le tissu te-

nu entre elles; **caractérisé par**

une butée d'arrêt (90) disposée sur une des surfaces de scellement opposables (39, 40) pour maintenir une distance de séparation minimale d'au moins environ 0,03 millimètre entre les surfaces de scellement opposables (39, 40); et un cliquet (60) disposé sur une des poignées fixe et mobile (50, 52) et au moins une interface mécanique d'interverrouillage complémentaire (55, 62) disposée sur l'autre des poignées fixe et mobile (50, 52), le cliquet (60) et l'interface mécanique d'interverrouillage complémentaire (62) réalisant au moins une position d'interverrouillage pour maintenir une force de fermeture dans la plage d'environ 3 kg/cm² à environ 16 kg/cm² entre les surfaces de scellement opposables (39, 40).

2. Instrument électrochirurgical bipolaire laparoscopique selon la revendication 1, où le matériau non-collant est un revêtement qui est déposé sur les surfaces de scellement opposables (39, 40).
3. Instrument électrochirurgical bipolaire laparoscopique selon la revendication 1 ou 2, où le revêtement non-collant est sélectionné dans un groupe de matériaux constitué de: nitrures et alliages nickel/chrome.
4. Instrument électrochirurgical bipolaire laparoscopique selon la revendication 3, où le revêtement non-collant comprend au moins l'un de: TiN, ZrN; TiAlN; CrN; des alliages nickel/chrome avec un rapport Ni/Cr d'environ 5:1; Inconel 600; Ni200; et Ni201. 30
5. Instrument électrochirurgical bipolaire laparoscopique selon la revendication 1, où les surfaces de scellement opposables (39, 40) sont fabriquées en un matériau non-collant. 35
6. Instrument électrochirurgical bipolaire laparoscopique selon la revendication 5, où le matériau non-collant est un alliage nickel-chrome. 40
7. Instrument électrochirurgical bipolaire laparoscopique selon la revendication 6, où le matériau non-collant comprend au moins un des alliages nickel/chrome avec un rapport Ni/Cr d'environ 5:1, Inconel 600, Ni200 et Ni201. 45
8. Instrument électrochirurgical bipolaire laparoscopique selon l'une quelconque des revendications précédentes, où au moins un des éléments de mâchoire (15,16), des poignées (14) et du tube oblong (13) comprend un matériau isolant disposé sur celui-ci. 50
9. Instrument électrochirurgical bipolaire laparoscopique selon la revendication 8, où le matériau isolant 55

est un revêtement isolant.

10. Instrument électrochirurgical bipolaire selon la revendication 8, où le matériau isolant est une gaine d'isolation.

5

10

15

20

25

30

35

40

45

50

55

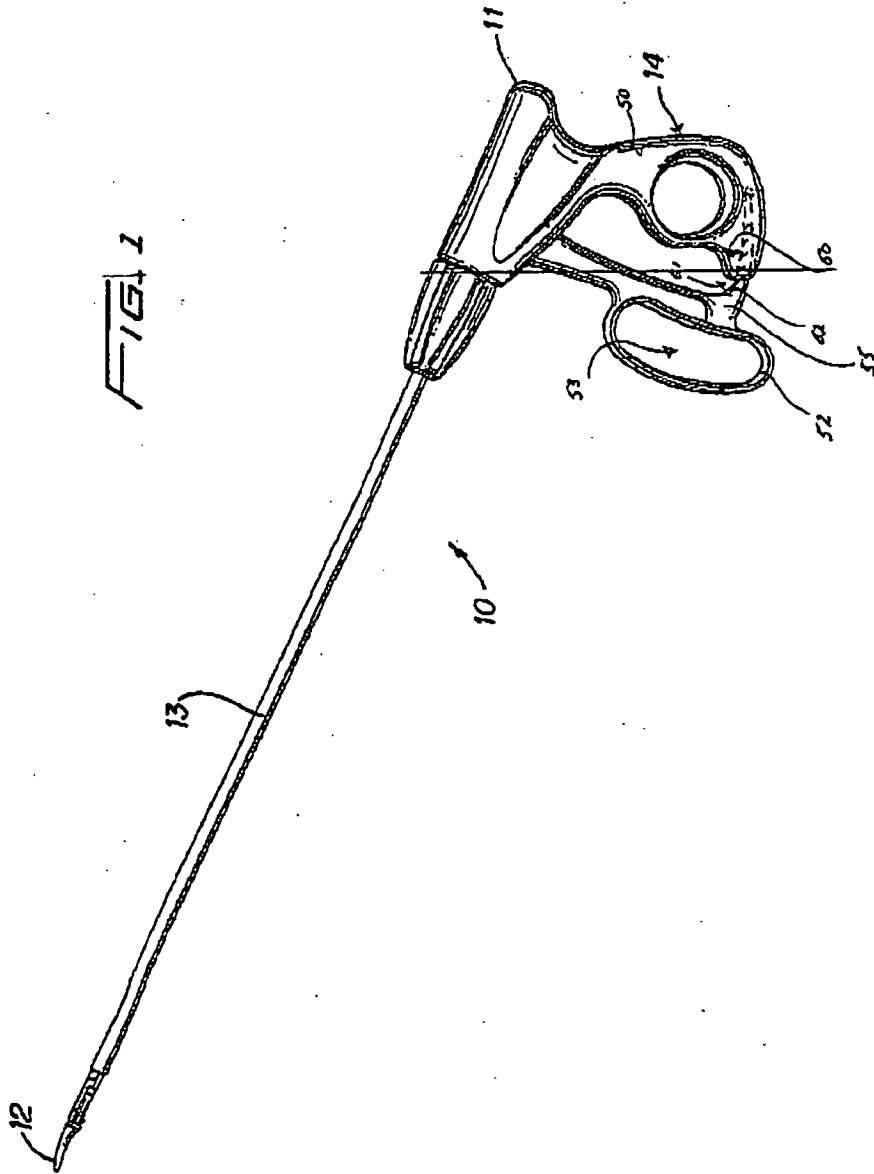

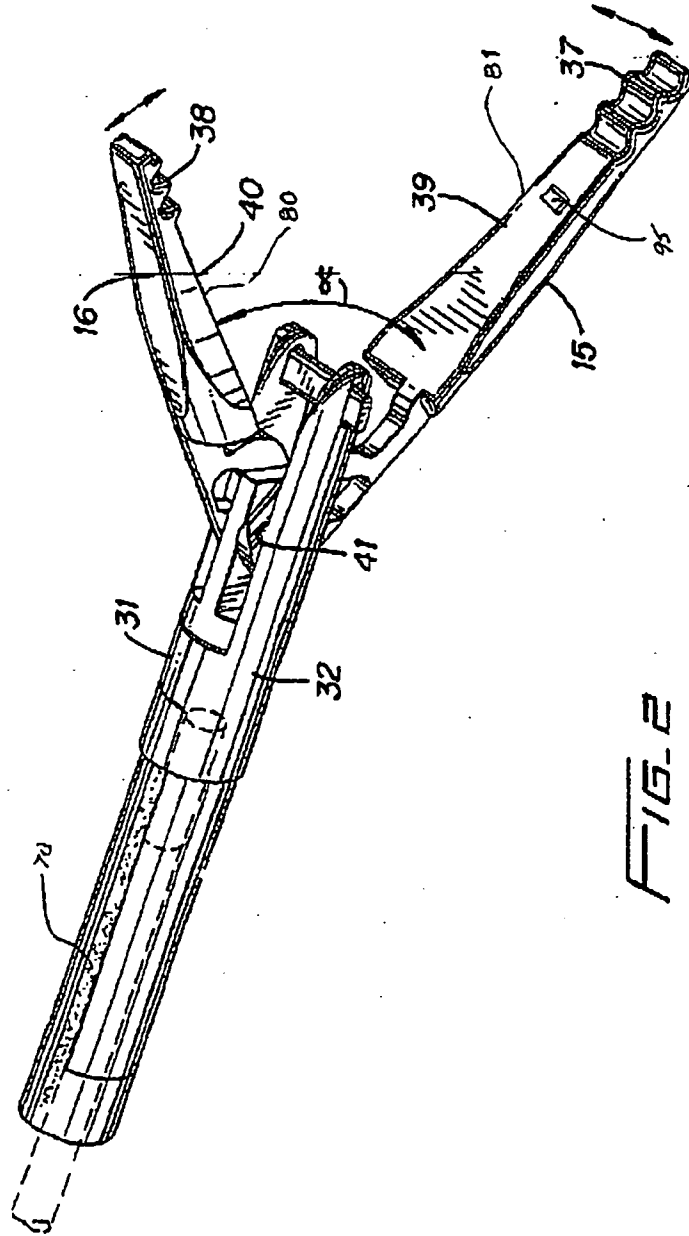

FIG. 2

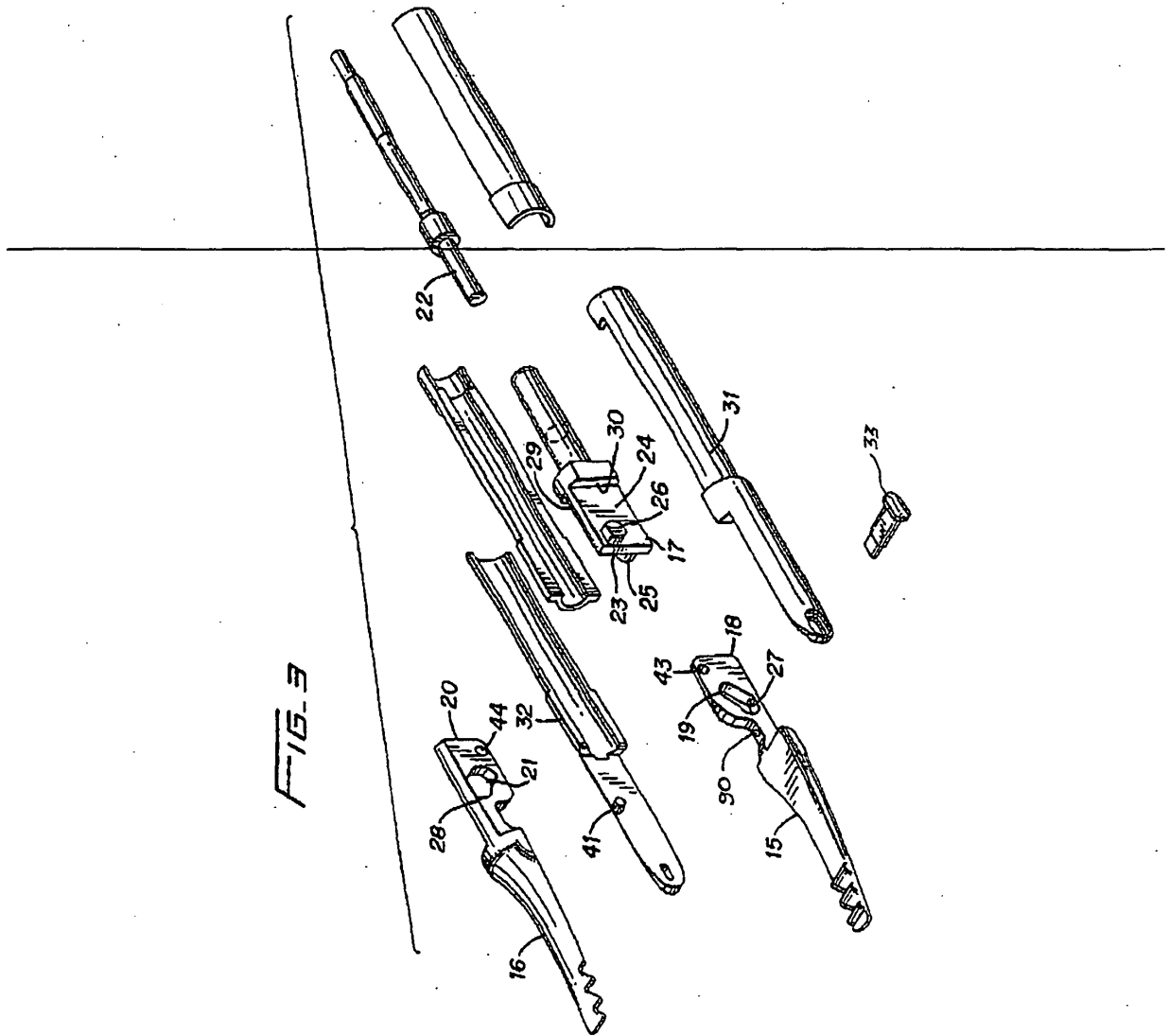

FIG. 4

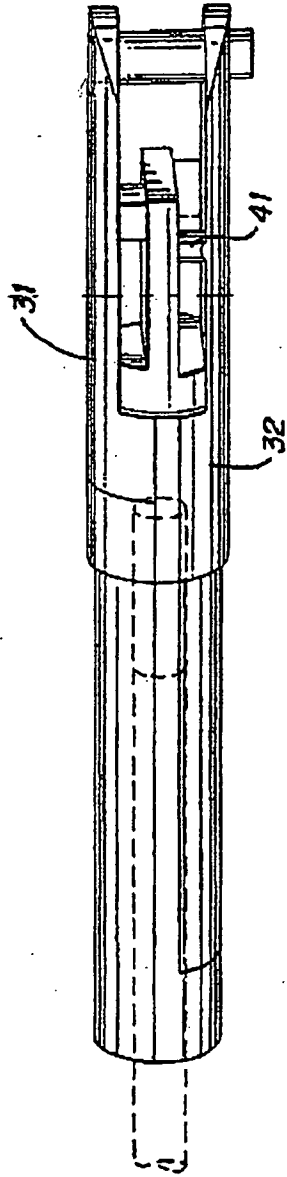

FIG. 5

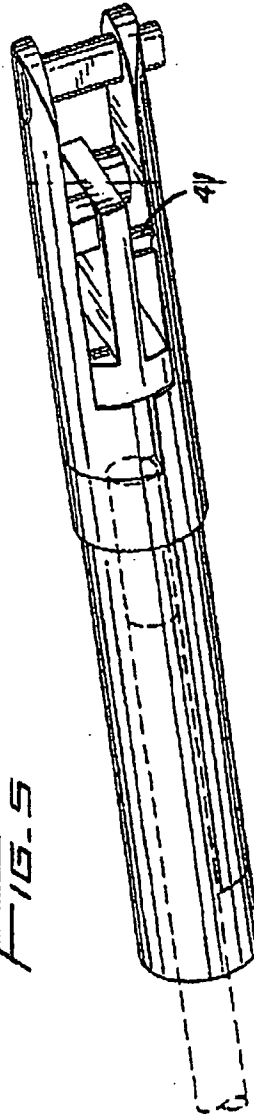

FIG. 6

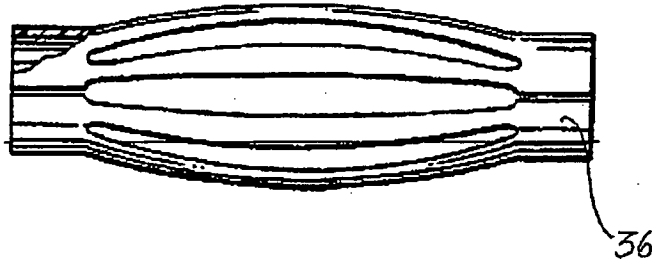
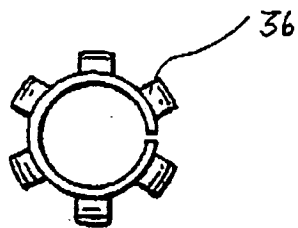

FIG. 7



REFERENCES CITED IN THE DESCRIPTION

This list of references cited by the applicant is for the reader's convenience only. It does not form part of the European patent document. Even though great care has been taken in compiling the references, errors or omissions cannot be excluded and the EPO disclaims all liability in this regard.

Patent documents cited in the description

- US 3938527 A [0007]
- US 5250047 A [0007]
- US 5445638 A [0007]
- US 5391166 A [0007]
- US 5342359 A [0007]

Non-patent literature cited in the description

- Studies on Coagulation and the Development of an Automatic Computerized Binolar Coaculator. *J. Neurosura*, July 1991, vol. 75 [0004]
- Automatically Controlled Bipolar Electrocoagulation-"COA-COMP. *Neurosurg. Rev.*, 1984, 187-190 [0004]

专利名称(译)	腹腔镜双极电外科仪器		
公开(公告)号	EP1683496B1	公开(公告)日	2008-12-10
申请号	EP2006008779	申请日	2003-06-03
[标]申请(专利权)人(译)	舍伍德服务股份公司		
申请(专利权)人(译)	SHERWOOD SERVICES AG		
当前申请(专利权)人(译)	COVIDIEN AG		
[标]发明人	BUYSSE STEVEN P LAWES KATE R SCHMALTZ DALE F LANDS MICHAEL J LUKIANOW S WADE JOHNSON KRISTIN D COUTURE GARY M NGUYEN LAP P		
发明人	BUYSSE, STEVEN P. LAWES, KATE R. SCHMALTZ, DALE F. LANDS, MICHAEL J. LUKIANOW, S. WADE JOHNSON, KRISTIN D. COUTURE, GARY M. NGUYEN, LAP, P.		
IPC分类号	A61B18/14 A61B17/28 A61B18/12 A61B19/00		
CPC分类号	A61B18/1445 A61B2018/00083 A61B2018/0063 A61B2090/034		
优先权	10/164654 2002-06-06 US 11/516480 2005-10-05 US		
其他公开文献	EP1683496A3 EP1683496A2		
外部链接	Espacenet		

摘要(译)

用于密封组织的腹腔镜双极电外科器械包括手柄，手柄具有固定到其上的细长管。该管包括连接到其远端的第一和第二钳口构件，钳口构件可从第一位置移动，其中第一和第二钳口构件相对于彼此以间隔关系设置到至少一个后续位置以抓取组织其间。第一和第二钳口构件中的每一个包括导电密封表面，第一钳口构件的导电密封表面基本上与第二钳口构件的导电密封表面相对。手柄包括固定手柄和可动手柄，可动手柄可相对于固定手柄移动，以实现第一和第二钳夹构件从第一位置到至少一个后续位置的运动用于抓取组织。可相对的密封表面包括用于在密封过程中减少组织粘附的不粘材料。第一和第二钳口构件适于连接到电外科能量源，使得可相对的密封表面能够通过保持在其间的组织传导电外科能量。另外，在一个可重复使用的密封表面上设置一个止动件，用于保持可相对应的密封表面之间的最小间隔距离；棘轮设置在固定和可动手柄中的一个上，并且至少一个互补的互锁机械接口设置在固定和可动手柄中

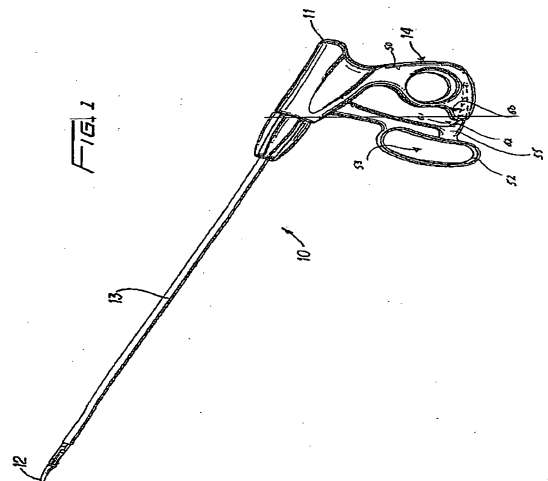

的另一个上。棘轮和互补的互锁机械接口提供至少一个互锁位置，以在相对的密封之间保持约 $3\text{kg} / \text{cm}^2$ 至约 $16\text{kg} / \text{cm}^2$ 的闭合力。表面。