

(19)



(11)

**EP 2 427 117 B1**

(12)

**EUROPEAN PATENT SPECIFICATION**

(45) Date of publication and mention of the grant of the patent:  
**09.10.2019 Bulletin 2019/41**

(51) Int Cl.:  
**A61B 8/12 (2006.01)**

(21) Application number: **10772828.9**

(86) International application number:  
**PCT/US2010/033873**

(22) Date of filing: **06.05.2010**

(87) International publication number:  
**WO 2010/129773 (11.11.2010 Gazette 2010/45)**

**(54) ULTRASOUND INSTRUMENT FOR ORTHOPEDIC APPLICATIONS**

ULTRASCHALLINSTRUMENT FÜR ORTHOPÄDISCHE ANWENDUNGEN

INSTRUMENT À ULTRASON POUR APPLICATIONS ORTHOPÉDIQUES

(84) Designated Contracting States:  
**AL AT BE BG CH CY CZ DE DK EE ES FI FR GB GR HR HU IE IS IT LI LT LU LV MC MK MT NL NO PL PT RO SE SI SK SM TR**

- **BARASO, Randall, R.**  
**Mount Pleasant, SC 29466 (US)**
- **TSUCHIDA, Kazutoshi**  
**Tokyo 198-0024 (JP)**
- **WAKABAYASHI, Hiroaki**  
**Musashino**  
**Tokyo 180-0023 (JP)**

(30) Priority: **07.05.2009 US 176373 P**

(43) Date of publication of application:  
**14.03.2012 Bulletin 2012/11**

(74) Representative: **Wunderlich & Heim**  
**Patentanwälte**  
**Partnerschaftsgesellschaft mbB**  
**Irmgardstrasse 3**  
**81479 München (DE)**

(73) Proprietors:  
• **Hitachi, Ltd.**  
**Chiyoda-ku,**  
**Tokyo 100-8280 (JP)**  
• **Frankel, Bruce M.**  
**Mount Pleasant, SC 29466 (US)**

(56) References cited:  
**EP-A1- 0 466 424**                      **WO-A1-95/19143**  
**WO-A1-95/19143**                      **WO-A2-2008/089496**  
**US-A- 5 512 034**                      **US-A1- 2006 235 299**  
**US-A1- 2007 293 791**                **US-A1- 2008 275 458**  
**US-B2- 7 211 055**                      **US-B2- 7 503 895**

(72) Inventors:  
• **FRANKEL, Bruce, M.**  
**Mount Pleasant, SC 29466 (US)**

**EP 2 427 117 B1**

Note: Within nine months of the publication of the mention of the grant of the European patent in the European Patent Bulletin, any person may give notice to the European Patent Office of opposition to that patent, in accordance with the Implementing Regulations. Notice of opposition shall not be deemed to have been filed until the opposition fee has been paid. (Art. 99(1) European Patent Convention).

**Description**BACKGROUND5    1. Cross-Reference to Related Applications

**[0001]** The present application claims the benefit of a co-pending provisional patent application entitled "Ultrasound for Orthopedic Application" which was filed on May 7, 2009, and assigned Serial No. 61/176,373.

10   2. Technical Field

**[0002]** The present disclosure relates generally to equipment and procedures in the field of spinal surgery and, in exemplary implementations, to instruments, systems and methods for positioning and/or evaluating the positioning of pedicle screws in connection with orthopedic applications.

15   3. Background Art

**[0003]** Surgical techniques for spinal fixation vary widely in terms of the types of surgical equipment used, but modern surgical practice continues to rely quite heavily on the strength and stability afforded by the common pedicle screw. However, care must be taken during pedicle screw placement to protect against nerve damage. For example, after forming a pilot hole in the bone tissue of a pedicle but before moving forward with pedicle screw implantation, a surgeon will typically take the opportunity to inspect the axially-extending side walls of the pilot hole to locate defects. With the advent and increasing use of minimally invasive surgical procedures that afford only a limited view with respect to anatomical structure, the risk of misplaced pedicle screws has increased. In the event a surgeon locates a breach of any significant size in the cortical bone adjacent the spinal column, he or she will mostly likely elect to redirect the screw to avoid the risk of complications such as pain, paralysis and hemorrhaging.

**[0004]** One method for locating such cortical breaches in regular use by surgeons is tissue palpation by means of the common tactile feeler probe. While all surgeons are aware that this method has its limitations, including with regard to sensitivity in the case of relatively small breaches, as well as with regard to false positives, many if not most have become comfortable with the use of the tactile feeler probe. To the extent techniques and tools can be developed to facilitate continued effective use of tactile diagnostic techniques in the context of minimally invasive spinal surgical procedures, there is likely to be a strong market for same among current practitioners.

**[0005]** Recent developments in the use of ultrasound technology in surgical applications have shown promise. With the increasing miniaturization of electronics generally has come the ability to position ultrasound transducers to beneficial effect in increasingly smaller and, at least up until recently, harder to reach anatomical locations. Nevertheless, and despite efforts to date, a need remains for convenient, sanitary, low-cost, and effective equipment and related techniques for locating pilot hole bone tissue defects prior to pedicle screw implantation.

**[0006]** These and other needs are satisfied by the instruments, systems and methods disclosed herein, as will be apparent from the detailed description which follows, particularly when read in conjunction with the figures appended hereto.

**[0007]** WO 2008/089496 A2 discloses an implementable medical device comprising an embedded ultrasound transducer. In this connection it is also disclosed a signal processing system which is configured to process the electrical signals of the transducer.

## 45   SUMMARY

**[0008]** The present disclosure provides advantageous instruments for obtaining and/or determining anatomical information, e.g., locating pilot hole bone tissue defects prior to pedicle screw implantation.

**[0009]** The invention is defined in the independent claims. Embodiments are defined in the dependent claims.

**[0010]** In examples, a medical diagnostic instrument is provided that includes (i) a proximal handle configured and dimensioned to permit an operator to manually grasp the instrument; (ii) an ultrasound probe including a longitudinal shaft extending distally from the handle and terminating in a distal end, and an ultrasound transducer mounted with respect to the longitudinal shaft proximate the distal end thereof, the ultrasound transducer including an array of ultrasonic energy generation elements; and (iii) a tactile feeler probe mounted with respect to the ultrasound probe, the tactile feeler probe including a longitudinal shaft mounted with respect to the longitudinal shaft of the ultrasound probe and extending distally beyond the distal end thereof, and a feeler probe tip (e.g., a ball tip) defined at a distal end of the longitudinal shaft of the tactile feeler probe.

5 [0011] The ultrasound transducer and the distal end are generally cooperatively configured, oriented, and dimensioned to permit the operator to insert the ultrasound transducer and the distal end into a desired anatomical location to permit the operator to obtain thereat a corresponding two-dimensional image of the anatomical location for visual inspection by the operator for purposes of detecting ultrasonically-detectable anatomical properties. The array of ultrasonic energy generation elements may be side-firing and may be oriented in a linear array or a phased array. In addition, the feeler probe tip and the longitudinal shaft of the tactile feeler probe are generally cooperatively configured and dimensioned to permit the operator to insert the feeler probe tip and the longitudinal shaft of the tactile feeler probe into the desired anatomical location to permit the operator to perform thereat a tactile inspection of the selected anatomical location.

10 [0012] The disclosed medical diagnostic instrument may be advantageously employed in connection with a pedicle screw pilot hole formed in the spine of the human patient. In addition, the array of ultrasonic energy generation elements of the ultrasound transducer may extend axially along, and be positioned against, a selected portion of a side wall of the pedicle screw pilot hole. The feeler probe tip may be positioned against the selected portion of the side wall of the pedicle screw pilot hole. The medical diagnostic instrument may also include at least one channel configured and dimensioned to receive a K-wire to permit the instrument to be slidably mounted thereto for purposes of guiding the ultrasound and tactile feeler probes axially relative to the desired anatomical location. Thus, the channel may be in the handle and extend therethrough, and/or be formed in an extension of the handle and extend therepast. The handle and the longitudinal shaft of the ultrasound probe may be of unitary construction or the ultrasonic probe may be mounted with respect to the handle such that the longitudinal shaft of the ultrasonic probe is supported, cantilever-style, by the handle housing. In addition, the tactile feeler probe may be mounted with respect to the ultrasound probe such that the longitudinal shaft of the tactile feeler probe is supported, cantilever-style, by the longitudinal shaft of the ultrasound probe.

15 [0013] The disclosed medical diagnostic instrument is typically adapted to cooperate with a cable assembly for carrying electrical signals to and from the ultrasound transducer in accordance with an ultrasonic imaging mode of use of the instrument. The cable assembly generally includes a proximal end including an electrical connector for connecting the instrument to a corresponding ultrasound console and current carrying wires extending distally from the electrical connector to the ultrasound transducer at least partially via a corresponding interior conduit formed in and extending longitudinally along the longitudinal shaft of the ultrasound probe. The current carrying wires also generally extend to the ultrasound transducer through the proximal end of the handle and through a corresponding interior conduit formed in and extending longitudinally along the longitudinal shaft of the handle.

20 [0014] The array of ultrasonic energy generation elements generally defines an axial length along the longitudinal shaft of the ultrasound probe of between about 8 millimeters and about 12 millimeters. In addition, the tactile feeler probe typically extends distally beyond the distal end of the longitudinal shaft of the ultrasound probe such that the longitudinal shaft and the feeler probe tip of the tactile feeler probe collectively define an axial length of the tactile feeler probe beyond the array of side-firing ultrasonic energy generation elements of between about 8 millimeters and about 12 millimeters.

25 [0015] The present disclosure also advantageously provides a medical diagnostic system for use in conjunction with bone tissue that includes:

30 a medical diagnostic instrument, the instrument including (i) a handle disposed proximate an operator of the instrument, the handle being configured and dimensioned to permit the operator to manually grasp the instrument and manipulate the instrument relative to the spine of a human patient; (ii) an ultrasound probe that includes a longitudinal shaft extending distally from the handle and terminating in a distal end, and an ultrasound transducer mounted to the longitudinal shaft proximate the distal end thereof, the ultrasound transducer including an array of side-firing ultrasonic energy generation elements extending along the longitudinal shaft, wherein the ultrasound transducer and the distal end are cooperatively configured, oriented, and dimensioned to permit the operator to insert the ultrasound transducer and the distal end into a desired anatomical location (e.g., a pedicle screw pilot hole formed in the spine of the human patient) such that the array of side-firing ultrasonic energy generation elements of the ultrasound transducer extends axially along, and is positioned against, a selected portion of the anatomical location, (iii) a tactile feeler probe mounted with respect to the ultrasound probe, the tactile feeler probe including a longitudinal shaft mounted with respect to the longitudinal shaft of the ultrasound probe and extending distally therefrom beyond the distal end thereof, and a feeler probe tip defined at a distal end of the longitudinal shaft of the tactile feeler probe, the feeler probe tip and the longitudinal shaft of the tactile feeler probe being cooperatively configured and dimensioned to permit the operator to insert the feeler probe tip and the longitudinal shaft of the tactile feeler probe into the desired anatomical location (e.g., a pedicle screw pilot hole) such that the feeler probe tip is positioned against the selected portion of the side wall of the pedicle screw pilot hole, and to permit the operator to perform thereat a tactile inspection of the desired anatomical location; and (iv) a first cable assembly for carrying electrical signals to and from the ultrasound transducer in accordance with an ultrasonic imaging mode of use of the instrument, the cable assembly including a proximal end including a first electrical connector for connecting the instrument to a corresponding ultrasound console and current carrying wires extending distally from the electrical connector, through the longitudinal shaft of the ultrasound probe and to the ultrasound transducer. The disclosed system may further include and/or be adapted to operate with an ultrasound console including a processor for controlling the medical diagnostic instrument, a display for displaying two-dimensional ultrasonic images obtained therefrom by an

operator thereof, and a port for receiving a corresponding cable connector; and a second cable assembly for carrying electrical signals to and from the ultrasound console, the second cable assembly including a second electrical connector coupled to a the port associated with the ultrasound console, a third electrical connector coupled to the first electrical connector, and current carrying wires extending therebetween.

5 **[0016]** Still further, the present disclosure provides an advantageous method of exploring a desired anatomical location (e.g., a pedicle screw pilot hole formed in the spine of a human patient for cortical breaches located in the axially-extending side-walls thereof) that includes:

10 presenting a medical diagnostic instrument that includes (i) a handle, (ii) an ultrasound probe that includes a longitudinal shaft extending distally from the handle and terminating in a distal end, and an ultrasound transducer mounted to the longitudinal shaft proximate the distal end thereof, the ultrasound transducer including an array of ultrasonic energy generation elements (e.g., side-firing) extending along the longitudinal shaft; and (iii) a tactile feeler probe mounted with respect to the ultrasound probe, the tactile feeler probe including a longitudinal shaft mounted with respect to the longitudinal shaft of the ultrasound probe and extending distally therefrom beyond the distal end thereof, and a feeler probe tip defined at a distal end of the longitudinal shaft of the tactile feeler probe;

15 employing the handle to manually grasp and manipulate the medical diagnostic instrument relative to the desired anatomical location (e.g., the spine of a human patient), including inserting the ultrasound transducer and the distal end of the longitudinal shaft of the ultrasound probe, and the feeler probe tip and the longitudinal shaft of the tactile feeler probe into the desired anatomical location;

20 positioning the array of ultrasonic energy generation elements of the ultrasound transducer relative to the desired anatomical location;

employing the array of ultrasonic energy generation elements of the ultrasound transducer to obtain a two-dimensional image of the desired anatomical location;

25 positioning the feeler probe tip of the tactile feeler probe relative to the desired anatomical location;

employing the feeler probe tip of the tactile feeler probe to perform a tactile inspection of the desired anatomical location; and

performing the two positioning and the two employing steps without removing any of the ultrasound transducer or the distal end of the longitudinal shaft of the tactile feeler probe or the feeler probe tip of the longitudinal shaft of the tactile feeler probe from the desired anatomical location.

30 **[0017]** Additional features, functions and benefits of the present disclosure will be apparent from the detailed description which follows, particularly when read in conjunction with the accompanying figures.

#### 35 BRIEF DESCRIPTION OF THE DRAWINGS

**[0018]** So that those having ordinary skill in the art to which the subject disclosure appertains will more readily understand how to construct and employ the systems, apparatus and methods of the subject disclosure, reference may be had to the drawings wherein:

40 FIG. 1 is schematic side elevational view of a medical diagnostic system in accordance with the present disclosure, the system including a medical diagnostic instrument, an ultrasound console, and associated cable assemblies for establishing communication therebetween;

FIGS. 2 and 5-7 are side elevational views of an exemplary medical diagnostic instrument in accordance with the present disclosure;

45 FIG.3 and 4 are side views of a medical diagnostic system according to the invention;

FIG. 7A is a partial side elevational view of an alternative exemplary medical diagnostic instrument in accordance with the present disclosure;

FIGS. 8 and 9 are side elevational and close-up side detail views, respectively, of a further embodiment of a medical diagnostic instrument in accordance with the present disclosure;

50 FIGS. 10 and 11 are respective side elevational and side detail views of a further exemplary embodiment of a medical diagnostic instrument in accordance with the present disclosure;

FIGS. 12, 13 and 14 are top plan, side elevational, and bottom plan views, respectively, of an additional exemplary embodiment of a medical diagnostic instrument in accordance with the present disclosure;

FIG. 15 is a side elevational view of an exemplary embodiment of a medical diagnostic instrument in accordance with the present disclosure for use in conjunction with a K-wire during minimally invasive spine surgery;

55 FIG. 15A is a side elevational view of an exemplary embodiment of a medical diagnostic instrument similar to the instrument of FIG. 15 in accordance with the present disclosure for use in conjunction with a K-wire (that may be introduced through alternative channels) during minimally invasive spine surgery;

FIG. 16 is a side elevational view of another exemplary embodiment of a medical diagnostic instrument in accordance with the present disclosure for use in conjunction with a K-wire during minimally invasive spine surgery; FIGS. 17, 18 and 19 illustrate various known spinal implant applications; FIGS. 20 - 25 illustrate various known screw placement techniques used with respect to different spinal levels; FIGS. 26 - 28 (L2/3 Listhesis), FIGS. 29-31 (L2 Burst Fracture), FIGS. 32-34 (L1 Burst Fracture), FIGS. 35-37 (Metastatic Bone Disease) and FIGS. 38 - 39 (Minimally Invasive Surgery) illustrate various examples of instrumented spine surgery in which the disclosed systems, apparatus and methods may be used for the benefit of spinal patients suffering from a variety of spinal diseases, degenerative conditions and/or diseases; FIGS. 40 and 41 illustrate existing technology for intra-operative location of breaches in the cortical bone tissue of spinal pedicles; FIGS. 42 - 50 set forth information associated with tests conducted with respect to animal vertebral bodies using an ultrasound probe in accordance with embodiments of the present disclosure; and FIGS. 51 - 55 set forth information associated with tests conducted with respect to human cadaveric subjects in accordance with embodiments of the present disclosure; FIGS. 56 - 57 are successive views of a medical diagnostic instrument in accordance with the present disclosure being used *in vivo* to locate potential pilot hole bone tissue defects prior to pedicle screw implantation; and FIGS. 58 - 59 are views of an implementation according to the present disclosure wherein a modified Jamshidi-style needle is used in combination with an ultrasound probe.

## DESCRIPTION OF EXEMPLARY EMBODIMENT(S)

**[0019]** In accordance with embodiments of the present disclosure, advantageous medical diagnostic instruments, systems and methods are provided for use during a broad variety of spinal surgical applications. The present disclosure provides improved equipment and advantageous methods for combining the comfort and familiarity of tactile inspection techniques with increasingly effective ultrasound imaging techniques to assist surgeons, for example, in quickly and conveniently inspecting pilot holes for bone tissue defects prior to pedicle screw implantation.

**[0020]** Referring now to FIG. 1, a medical diagnostic system 101 in accordance with embodiments of the present disclosure is shown. The system 101 includes a medical diagnostic instrument 103 which may include a first cable assembly 105. The system 103 also includes an ultrasound console 107 and a second cable assembly 109.

**[0021]** The instrument 103 includes a handle 111. The handle 111 is disposable proximate an operator (not shown) of the instrument 103 and is configured and dimensioned to permit the operator (not shown) to manually grasp the instrument 103, and to manipulate the instrument 103 relative to the spine of a human patient (not shown).

**[0022]** The instrument 103 further includes an ultrasound probe 113. The ultrasound probe 113 includes a longitudinal shaft 115 extending distally from the handle 111 and terminating in a distal end 117. The ultrasound probe 113 further includes an ultrasound transducer 119 mounted to the longitudinal shaft 115 proximate the distal end 117 thereof. The ultrasound transducer 119 includes an array of side-firing ultrasonic energy generation elements (not separately shown) extending along the longitudinal shaft 115.

**[0023]** The ultrasound transducer 119 and the distal end 117 are cooperatively configured, oriented, and dimensioned to permit the operator (not shown) to insert the ultrasound transducer 119 and the distal end 117 into a pedicle screw pilot hole (not shown) formed in the spine of the human patient (not shown) such that the array of side-firing ultrasonic energy generation elements of the ultrasound transducer 119 extends axially along, and is positioned against, a selected portion of a side wall (not shown) of the pedicle screw pilot hole, and to permit the operator to obtain thereat a corresponding two-dimensional image (not shown) of the selected portion of the side wall for visual inspection by the operator for purposes of detecting ultrasonically-detectable cortical breaches located therein (not shown).

**[0024]** The instrument 103 further includes a tactile feeler probe 121 mounted with respect to the ultrasound probe 113, the tactile feeler probe 121 including a longitudinal shaft 123 mounted with respect to the longitudinal shaft 115 of the ultrasound probe 113 and extending distally therefrom beyond the distal end 117 thereof, and a feeler probe tip 125 defined at a distal end 127 of the longitudinal shaft 123 of the tactile feeler probe 121, the feeler probe tip 125 and the longitudinal shaft 123 of the tactile feeler probe 121 being cooperatively configured and dimensioned to permit the operator (not shown) to insert the feeler probe tip 125 and the longitudinal shaft 123 of the tactile feeler probe 121 into the pedicle screw pilot hole (not shown) such that the feeler probe tip 125 is positioned against the selected portion of the side wall of the pedicle screw pilot hole (not shown), and to permit the operator to perform thereat a tactile inspection of the selected portion of the side wall of the pedicle screw pilot hole for purposes of detecting manually detectable cortical breaches located therein (not shown).

**[0025]** As indicated above, the instrument 103 may further include a first cable assembly 105. The first cable assembly 105 may be configured and arranged to carry electrical signals to and from the ultrasound transducer 119 in accordance with an ultrasonic imaging mode of use of the instrument 103. The first cable assembly 105 may include a proximal end 129 including a first electrical connector 131 for connecting the instrument 103 to a corresponding ultrasound console

107 and current carrying wires (not separately shown) extending distally from the electrical connector 131, through the longitudinal shaft 123 of the ultrasound probe 113 and to the ultrasound transducer 119.

5 [0026] The ultrasound console 107 includes a processor 133 for controlling the instrument 103, a display 135 for displaying two-dimensional ultrasonic images obtained from the instrument 103 by an operator thereof, and a port 137 for receiving a corresponding cable connector.

[0027] As indicated above, the system 101 includes a second cable assembly 109 for carrying electrical signals to and from the ultrasound console 107. The second cable assembly 109 includes a second electrical connector 139 coupled to a the port 137 associated with the ultrasound console 107, a third electrical connector 141 coupled to the first electrical connector 131, and current carrying wires (not separately shown) extending therebetween.

10 [0028] The connection between the third electrical connector 141 of the second cable assembly 109 and the first electrical connector 131 of the first cable assembly may be an umbilical connection between a disposable portion 143 of the medical diagnostic system 101 including the medical diagnostic instrument 103, and a non-disposable portion 145 of the medical diagnostic system 101 including the ultrasound console 107 and the second cable assembly 109.

15 [0029] Turning now to FIGS. 1 and 2, the longitudinal shaft 123 of the tactile feeler probe 121 may define a longitudinal axis 201 along which the longitudinal shaft 123 of the tactile feeler probe 121 extends distally from the longitudinal shaft 115 of the ultrasound probe 113, and a longitudinal axis 203 along which the longitudinal shaft 123 of the tactile feeler probe 121 extends distally to the feeler probe tip 125, and a bend 205 formed therebetween such that the longitudinal axis 201 and the longitudinal axis 203 collectively define a first plane (represented in FIG. 2 by the plane in which FIG. 2 appears). The longitudinal shaft 115 of the ultrasound probe 113 may define a longitudinal axis 207 along which the longitudinal shaft 115 of the ultrasound probe 113 extends distally from the handle 111. The side-firing ultrasonic energy generation elements of the array thereof (not separately shown) may define a longitudinal axis 209 along which the array of side-firing ultrasonic energy generation elements extends.

20 [0030] As indicated in FIG. 2 at reference numeral 211, the longitudinal axis 209 associated with the side-firing ultrasonic energy elements of the array thereof may be radially offset from the longitudinal axis 207 associated with the longitudinal shaft 115 of the ultrasound probe 113. In such circumstances, the longitudinal axis 207 and the longitudinal axis 209 may collectively define a second plane (represented in FIG. 2 by the plane in which FIG. 2 appears) that is coplanar with the first plane.

25 [0031] As indicated in FIG. 2 at reference numeral 213, the feeler probe tip 125 may be radially offset from the longitudinal axis 207 associated with the longitudinal shaft 115 of the ultrasound probe 113. In such circumstances, each of the feeler probe tip 125 and the longitudinal axis 209 associated with the array of side-firing ultrasonic energy generation elements may be offset from the longitudinal axis 207 in a common radial direction therefrom such that the feeler probe tip 125 and the array of side-firing ultrasonic energy generation elements are rotationally aligned with each other relative to the longitudinal shaft 115 of the ultrasound probe 113. Alternatively (not shown in FIG. 2), the feeler probe tip 125 may be disposed on the longitudinal axis 207 associated with the longitudinal shaft 115 of the ultrasound probe 113.

30 [0032] Still referring to FIG. 2, the handle 111 may include a longitudinal shaft 215 extending proximally from the ultrasound probe 113 and terminate in a proximal end 217. The longitudinal shaft 215 may define a longitudinal axis 219 along which the handle 111 extends proximally from the ultrasound probe 113. As shown in FIG. 2, the longitudinal axis 217 may be disposed in the first plane (represented in FIG. 2 by the plane in which FIG. 2 appears). In such circumstances, the longitudinal axis 219 associated with the handle may be positioned and oriented coaxially with respect to the longitudinal axis 207 associated with the longitudinal shaft 115 of the ultrasound probe 113 such that the handle 211 and the ultrasound probe 113 are longitudinally aligned with each other.

35 [0033] As indicated in FIG. 2 at reference numeral 221, the array of side-firing ultrasonic energy generation elements may define an axial length along the longitudinal shaft 115 of the ultrasound probe 113 of between about 8 millimeters and about 12 millimeters. For example, the array of side-firing ultrasonic energy generation elements may define an axial length along the longitudinal shaft 115 of the ultrasound probe 113 of about 10 millimeters.

40 [0034] As indicated in FIG. 2 at reference numeral 223, the tactile feeler probe 121 extending distally beyond the distal end 117 of the longitudinal shaft 115 of the ultrasound probe 113 may include wherein the longitudinal shaft 123 and the feeler probe tip 125 of the tactile feeler probe 121 may collectively define an axial length of the tactile feeler probe 121 beyond the array of side-firing ultrasonic energy generation elements of between about 8 millimeters and about 12 millimeters. For example, the feeler probe tip 125 of the tactile feeler probe 121 may collectively define an axial length of the tactile feeler probe 121 beyond the array of side-firing ultrasonic energy generation elements of about 10 millimeters.

45 [0035] As indicated in FIG. 2 at reference numeral 225, the ultrasound transducer 119 and the distal end 117 being cooperatively configured, oriented, and dimensioned to permit the operator to insert the ultrasound transducer 119 and the distal end 117 into a pedicle screw pilot hole formed in the spine of the human patient (not shown) includes wherein the ultrasound transducer 119 and the distal end 117 define a transverse width or diameter of between about 2 millimeters and 4 millimeters. For example, the ultrasound transducer 119 and the distal end 117 define a transverse width or diameter of about 3 millimeters.

50 [0036] As shown in FIGS. 1 and 2, the feeler probe tip 125 may be a ball tip. The array of side-firing ultrasonic energy

generation elements associated with the ultrasound transducer 119 may be a linear array. Alternatively, 17. the array of side-firing ultrasonic energy generation elements associated with the ultrasound transducer 119 may be a phased array. Other types of arrays are possible as well.

5 [0037] A medical diagnostic instrument 301 according to the invention is shown in Fig.3. The instrument 301 may be structurally and functionally similar to the instrument 103 discussed above with reference to FIGS. 1 and 2, with some differences. The instrument 301 includes a tactile feeler probe 303 that is mounted with respect to the ultrasound probe 305 such that the longitudinal shaft 307 of the tactile feeler probe 303 is supported, cantilever-style, by the longitudinal shaft 309 of the ultrasound probe 305. Also as shown, at least some longitudinal overlap exists between the longitudinal shaft 307 of the tactile feeler probe 303 and the longitudinal shaft 309 of the ultrasound probe. In the embodiment shown in FIG. 3, the longitudinal shaft 307 of the tactile feeler probe 303 includes no major bends and is mounted atop the longitudinal shaft 309 of the ultrasound probe 305.

10 [0038] Turning now to FIG. 4, another medical diagnostic instrument 401 according to the invention is shown. The instrument 401 may be structurally and functionally similar to the instrument 103 discussed above with reference to FIGS. 1 and 2, with some differences. The instrument 401 includes a tactile feeler probe 403 that is mounted with respect to the ultrasound probe 405 such that the longitudinal shaft 407 of the tactile feeler probe 403 is supported, cantilever-style, by the longitudinal shaft 409 of the ultrasound probe 405. Also as shown, at least some longitudinal overlap exists between the longitudinal shaft 407 of the tactile feeler probe 403 and the longitudinal shaft 409 of the ultrasound probe. In the embodiment shown in FIG. 4, the longitudinal shaft 407 of the tactile feeler probe 403 includes no major bends. A proximal end 411 of the longitudinal shaft 407 of the tactile feeler probe 403 is lodged within a complementary cavity 413 formed in the longitudinal shaft 409 of the ultrasound probe 405 adjacent the distal end 415 thereof.

20 [0039] Referring now to FIG. 5, a medical diagnostic instrument 501 in accordance with embodiments of the present disclosure is shown. The instrument 501 may be structurally and functionally similar to the instrument 103 discussed above with reference to FIGS. 1 and 2, with some differences. The instrument 501 includes no tactile feeler probe. Otherwise, the instrument 501 is configured and dimensioned substantially identically to the instrument 103.

25 [0040] A medical diagnostic instrument 601 in accordance with embodiments of the present disclosure is shown in FIG. 6. The instrument 601 is configured and dimensioned substantially identically to the instrument 103, with differences as discussed below in the handle 603 of the instrument 601 as compared to the handle 111 of the instrument 103. The longitudinal shaft 605 of the handle 603 defines a further longitudinal axis 607 disposed in the plane of FIG. 6 and along which the longitudinal shaft 605 of the handle 603 extends proximally to the proximal end 609 of the handle 603, and a bend 611 formed between the longitudinal axis 607 and the longitudinal axis 613 such that an angle defined between the longitudinal axis 607 and the longitudinal axis 615 is larger than an angle defined between the longitudinal axis 613 and the longitudinal axis 615, and such that the handle 603 functions as a bayonet handle relative to the ultrasound and feeler probes 617, 619.

30 [0041] Turning now to FIG. 7, a medical diagnostic instrument 701 in accordance with embodiments of the present disclosure is shown. The instrument 701 may be structurally and functionally similar to the instrument 601 discussed above with reference to FIG. 6, with some differences. The instrument 701 includes no tactile feeler probe. Otherwise, the instrument 701 is configured and dimensioned substantially identically to the instrument 601. Of note, the ultrasonic energy generation elements may be oriented on opposite sides of the ultrasound probe, as will be apparent to persons skilled in the art. In addition, FIG. 7A shows the distal end of an alternative version of the disclosed diagnostic medical instrument 701A in which the an array of ultrasonic energy generation elements are axially aligned with the ultrasound probe such that the ultrasound energy from the ultrasound probe is directed substantially axially, i.e., in a substantially forward direction.

35 [0042] FIGS. 8 and 9 include respective side and close-up cutaway side views of a medical diagnostic instrument 801 in accordance with embodiments of the present disclosure. The instrument 801 may be structurally and functionally similar to the instrument 103 discussed above with reference to FIGS. 1 and 2, with some differences. The handle 803 of the diagnostic instrument 801 includes a housing 805. The ultrasonic probe 807 is mounted with respect to the handle 803 such that the longitudinal shaft 809 of the ultrasonic probe 807 is supported, cantilever-style, by the handle housing 805. The tactile feeler probe 811 is mounted with respect to the ultrasound probe 807 such that the longitudinal shaft 813 of the tactile feeler probe 811 is supported, cantilever-style, by the longitudinal shaft 809 of the ultrasound probe 807. In accordance with some embodiments of the present disclosure, including the embodiment shown in FIGS. 8 and 9, there is no overlap between the longitudinal shaft 809 of the ultrasound probe and the longitudinal shaft 813 of the tactile feeler probe 811. Instead, the tactile feeler probe 811 is mounted directly to the distal end 815 of the longitudinal shaft 809 of the ultrasound probe 807 via a proximal shoulder portion 817 of the tactile feeler probe 813.

40 [0043] Turning now to FIGS. 10 and 11, a medical diagnostic instrument 1001 in accordance with embodiments of the present disclosure is shown. The instrument 1001 may be structurally and functionally similar to the instrument 401 discussed above with reference to FIG. 4, with some differences. In accordance with some embodiments of the present disclosure, including the embodiment shown in FIGS. 10 and 11, there is no overlap between the longitudinal shaft 1003 of the ultrasound probe 1005 and the longitudinal shaft 1007 of the tactile feeler probe 1009. Instead, the tactile feeler

probe 1009 is mounted directly to the distal end 1011 of the longitudinal shaft 1003 of the ultrasound probe 1005 via a proximal shoulder portion 1013 of the tactile feeler probe 100.

5 [0044] Referring now to FIGS. 12, 13 and 14, a medical diagnostic instrument 1201 in accordance with embodiments of the present disclosure is shown. The instrument 1201 may be structurally and functionally similar to the instrument 501 discussed above with reference to FIG. 5, with some differences. The longitudinal axis 1203 associated with the longitudinal shaft 1205 of the ultrasound probe 1207 may be radially offset from the longitudinal axis 1209 associated with the longitudinal shaft 1211 of the ultrasound probe 1213.

10 [0045] Turning now to FIG. 15, a medical diagnostic instrument 1501 in accordance with embodiments of the present disclosure is shown. The instrument 1501 may be structurally and functionally similar to the instrument 601 discussed above with reference to FIG. 6, with certain additional features. The handle 1503 of the diagnostic instrument 1501 includes a housing 1505. In the housing 1505 of the handle 1503 is formed a channel 1507 configured and dimensioned to receive a K-wire 1509 to permit the instrument 1501 to be slidably mounted thereto for purposes of guiding the ultrasound and tactile feeler probes 1511, 1513 axially relative to the pedicle screw pilot hole, including during a minimally invasive surgical procedure, the channel 1507 being formed in the housing 1505 of the handle 1503 and extending through the handle 1503.

15 [0046] With reference to FIG. 15A, an alternative medical diagnostic instrument 1501A is shown in which handle 1503A includes a housing 1505A that defines first channel 1507A and second channel 1508A. Both channels 1507A and 1508A are configured and dimensioned to receive a K-wire, e.g., K-wire 1509A and/or K-wire 1512A, to permit the instrument 1501A to be slidably mounted thereto for purposes of guiding the ultrasound and tactile feeler probes 1511A, 1513A axially relative to the pedicle screw pilot hole, including during a minimally invasive surgical procedure. Thus, the channels 1507A and 1508A are formed in the housing 1505A of the handle 1503A and extend therethrough. In use, the operator/surgeon would be free to select the channel to be used for K-wire introduction, e.g., based on whether the operator/surgeon desires to see the K-wire pass the ultrasound probe.

20 [0047] Turning now to FIG. 16, a medical diagnostic instrument 1601 in accordance with embodiments of the present disclosure is shown. The instrument 1601 may be structurally and functionally similar to the instrument 601 discussed above with reference to FIG. 6, with certain additional features. The handle 1603 of the diagnostic instrument 1601 includes a housing 1605. A channel 1607 is configured and dimensioned to receive a K-wire 1609 to permit the instrument 1601 to be slidably mounted thereto for purposes of guiding the ultrasound and tactile feeler probes 1611, 1613 axially relative to the pedicle screw pilot hole, including during a minimally invasive surgical procedure, the channel 1607 being formed in an extension 1615 of the housing 1605 of the handle 1603 and extending past the handle 1603.

25 [0048] Variations and modifications of the above-described medical diagnostic instruments are possible in accordance with embodiments of the present disclosure. In accordance with some such variations and modifications (not shown), the handle and the longitudinal shaft of the ultrasound probe are of unitary construction with respect to each other. Each of the above-described diagnostic instruments may be equipped with a cable assembly for carrying electrical signals to and from the ultrasound transducer in accordance with an ultrasonic imaging mode of use of the instrument, the cable assembly including a proximal end including an electrical connector for connecting the instrument to a corresponding ultrasound console and current carrying wires extending distally from the electrical connector to the ultrasound transducer at least partially via a corresponding interior conduit formed in and extending longitudinally along the longitudinal shaft of the ultrasound probe. Other variations and modifications are possible.

30 [0049] Thus, the present disclosure provides, *inter alia*, advantageously integrated medical diagnostic instruments, systems incorporating such instruments, and methods of use of such instruments and systems for the benefit of such surgical practitioners and their patients. Practitioners may employ the presently disclosed technology in connection with a broad variety of surgical applications, including with respect to any bone in the human body in which a screw may be inserted. For example and/or in particular, surgical practitioners may advantageously apply the presently disclosed technology for the benefit of spine patients, including with respect to the specific application of intrapedicular screw implantation.

35 [0050] Further details of the use of the presently disclosed technology with respect to the specific application of intrapedicular screw implantation are provided hereinbelow. Based at least in part on the results of testing performed in connection with the presently disclosed technology, the disclosed instruments, systems, and methods of the present disclosure can be seen to address a variety of compelling needs long felt by surgical practitioners. For example, the presently disclosed technology addresses the perpetually growing demand on the part of such professionals for effective instruments, systems and related surgical methods for use in connection with such applications as cervical spine surgery, thoracic spine surgery, lumbar spine surgery, and sacral spine surgery, including surgery performed for the benefit of patients suffering from spinal trauma, spinal tumors, degenerative spine disorders, scoliosis and other diseases and conditions.

40 [0051] Turning now to FIGS. 17, 18, and 19, various known spinal implant applications are illustrated. A spinal implant 1701 shown in side elevational view in FIG. 17, including at least one spinal support rod 1703, is placed adjacent to and extending across multiple spinal levels including L3, L2, L1, T12, T11 and T10 to compensate for deterioration in or

damage done to the L1 pedicle. Another spinal implant 1801 is shown in rear elevational view in FIG. 18, including angled and cross-connected spinal support rods 1803, 1805, each extending across a corresponding side of multiple spinal levels. A further spinal implant 1901 is shown in side elevational view in FIG. 19, including a spinal support rod 1903 placed adjacent to and extending across spinal levels L4, L3 and L2 to compensate for deterioration in or damage done to the L3 pedicle, such spinal implant 1901 including respective pedicle screws 1905 affixed to the adjacent L2 and L4 pedicles. The presently disclosed technology may be employed in conjunction with any or all such spinal implant applications, as well as spinal implant applications similar thereto.

**[0052]** Referring now to FIGS. 20, 21, 22, 23, 24 and 25, various known screw placement techniques are shown for use with respect to different spinal levels, including with respect to a first pedicle 2001 shown in rear elevational, top plan and side elevational views in FIGS. 20, 21, and 22, respectively, a second pedicle 2301 shown in rear elevational and top plan views in FIGS. 23 and 24, respectively, and a third pedicle 2501 shown in top plan view in FIG. 25. The presently disclosed technology may be employed in conjunction with any or all such pedicle screw placement techniques, as well as pedicle screw placement techniques similar thereto.

**[0053]** Various case examples of instrumented spine surgery to which the presently disclosed technology may be applied for the benefit of spinal patients suffering from a variety of spinal diseases, degenerative conditions and diseases, are shown in FIGS. 26-39. A spinal implant 2601 is shown via FIGS. 26, 27 and 28, such implant having been implanted for the benefit of a patient afflicted with an L2/3 listhesis. A spinal implant 2901 is shown via FIGS. 29, 30 and 31, such implant having been implanted for the benefit of a patient that suffered an L2 burst fracture. A patient suffering from an L1 burst, including progressive Kyphosis, pain and paraparesis, may benefit from implantation of a spinal implant 3201, as shown in FIGS. 32, 33 and 34. A patient diagnosed with metastatic bone disease may be treated with spinal surgical apparatus 3501, as shown in FIGS. 35, 36 and 37. Images of spinal surgical apparatus 3801, 3803 and 3805, and an associated spinal implant 3901, are shown in FIGS. 38 and 39 (in which an example of minimally invasive surgery is illustrated). As discussed, the presently disclosed technology may be employed in conjunction with such spinal implant applications, as well as spinal implant applications similar thereto.

**[0054]** Referring now to FIGS. 40 and 41, existing technology for locating breaches in the cortical bone tissue of spinal pedicles is depicted. More particularly, diagnostic apparatus such as the apparatus 4001 may be used with integrated display technology (such as a screen display 4101) to implement a scheme for intraoperative monitoring of electrical current with respect to a predetermined threshold, wherein observed current in excess of the predetermined threshold is taken as a strong indication of the presence of an inappropriate cortical breach. However, the systems, apparatus and methods of the present disclosure offer superior results and clinical benefits as compared to such prior art technology.

**[0055]** Referring now to information shown and described in FIGS. 42-50, tests have been performed with respect to animal vertebral bodies using a 2.7 mm diameter ultrasound probe in accordance with embodiments of the present disclosure. Associated test materials are shown in FIG. 42, relevant anatomy is shown in FIG. 43, and associated testing methods are illustrated in FIG. 44. Large and small pedicle breaches are exemplified in images encompassed by FIG. 45. Examples of test materials presenting an intact pedicle (i.e., a pedicle having no breach in the side walls of the pedicle entry hole such as would result in the pedicle entry hole communicating with the spinal canal) are shown in images encompassed by FIG. 46. Examples of experimental controls, including with respect to the response of the probe in air and water, are shown in FIG. 47. The images of FIG. 48 show that no applicable signal was detected with the test probe in the example of an intact pedicle with no breach. As shown in FIG. 49, employment of the test probe in conjunction with test materials in which a large pedicle breach was present resulted in the test probe detecting such large breach. As shown in FIG. 50, employment of the test probe in conjunction with test materials in which a small pedicle breach was present resulted in the test probe detecting such small breach.

**[0056]** Referring now to information shown and described in FIGS. 51-55, further tests have been conducted with respect to human cadaveric subjects. FIG. 51 illustrates a related test setup. As shown in images encompassed by FIG. 52, the tests included the use of a 3.18 mm side-firing ultrasound probe fitted with a detachable pedicle feeler/sounder in accordance with the present disclosure. Various methods and techniques associated with the human cadaveric tests are shown in the images encompassed by FIG. 53. Some results corresponding to data collected and compared for a metal pedicle feeler (top) versus the use of pedicle ultrasound in accordance with the techniques and apparatus of the present disclosure are shown in the images encompassed by FIG. 54. Further results exemplifying the diagnostic power of the techniques and apparatus of the present disclosure, are shown in the images encompassed by FIG. 55 and corresponding respectively to: 1) a normal pedicle with no breach, 2) a 2.5 mm pedicle breach, and 3) a 4.0 mm pedicle breach.

**[0057]** Test results with respect to 2.5 mm and 4.0 mm pedicle breaches and related explanatory information are set forth in the following tables. For purposes of the tables, the following terms are defined:

- Sensitivity = (# true pos.) / [(# true pos.) + (# false neg.)]
- Specificity = (# true neg.) / [(# true neg.) + (# false pos.)]
- Positive Predictive Value (PPV) = (# true pos.) / [(# true pos.) + (# false pos.)]

**EP 2 427 117 B1**

- Negative Predictive Value (NPV) = (# true neg.) / [(# true neg.) + (# false neg.)]

TABLE 1

	Test Results; 2.5 mm Pedicle Breach		
	Pedicle Feeler	Pedicle Ultrasound #1	Pedicle Ultrasound #2
Sensitivity	66.7%	85.7%	85.7%
Specificity	80%	80%	80%
PPV	85.7%	85.7%	85.7%
NPV	57%	80%	80%

TABLE 2

	Test Results; 4.0 mm Pedicle Breach		
	Pedicle Feeler	Pedicle Ultrasound #1	Pedicle Ultrasound #2
Sensitivity	85.7%	100%	100%
Specificity	100%	100%	100%
PPV	100%	100%	100%
NPV	80%	100%	100%

**[0058]** Based on the foregoing test results, including specifically the noted human cadaveric tests, the following conclusions have been reached:

- The disclosed apparatus, systems and methods (pedicle ultrasound) has a higher sensitivity and negative predictive value as compared to the "classic" pedicle feeler.
- The noted difference is greater with extremely small breaches (2.5 mm vs. 4.0 mm)
- With larger breaches (4.0 mm), the detection of breaches approaches a sensitivity and specificity of 100% using the pedicle ultrasound system.
- The disclosed apparatus, systems and methods facilitate screening tests and/or related diagnostics to determine/detect whether a breach in cortical bone has occurred when placing pedicle screws into the spine.
- The disclosed apparatus, systems and methods allow surgeons and other health care personnel to reduce the likelihood that pedicle screws will be misplaced in spinal surgery, thereby translating to more effective health care.

**[0059]** In operation, and as illustrated in FIGS. 56 and 57, the above described diagnostic instruments may be used to explore a pedicle screw pilot hole formed in the spine of a human patient for cortical breaches located in the axially-extending side-walls thereof. As shown in FIGS. 56 and 57, a medical diagnostic instrument 6001 in accordance with the present disclosure is presented. The instrument includes a handle, an ultrasound probe, and a tactile feeler probe. The ultrasound probe includes a longitudinal shaft extending distally from the handle and terminating in a distal end, and an ultrasound transducer mounted to the longitudinal shaft proximate the distal end thereof. The ultrasound transducer includes an array of side-firing ultrasonic energy generation elements extending along the longitudinal shaft.

**[0060]** The tactile feeler probe is mounted with respect to the ultrasound probe and includes a longitudinal shaft mounted with respect to the longitudinal shaft of the ultrasound probe and extending distally therefrom beyond the distal end thereof. The tactile feeler probe includes a feeler probe tip defined at a distal end of the longitudinal shaft of the tactile feeler probe.

**[0061]** The handle is employed to manually grasp and manipulate the medical diagnostic instrument relative to the spine of a human patient, including inserting the ultrasound transducer and the distal end of the longitudinal shaft of the ultrasound probe, and the feeler probe tip and the longitudinal shaft of the tactile feeler probe into a pedicle screw pilot hole formed in the spine of the human patient.

**[0062]** The feeler probe tip of the tactile feeler probe is positioned relative to a selected portion of the side wall of the pedicle screw pilot hole such that the feeler probe tip is positioned against the side wall of the pedicle screw pilot hole.

**[0063]** The feeler probe tip of the tactile feeler probe is employed to perform a tactile inspection of the selected portion

of the side wall for purposes of detecting manually-detectable cortical breaches located therein.

**[0064]** The array of side-firing ultrasonic energy generation elements of the ultrasound transducer are positioned relative to selected portion of a side wall of the pedicle screw pilot hole such that the array of side-firing ultrasonic energy generation elements extends axially along, and is positioned against, the selected portion of a side wall of the pedicle screw pilot hole.

**[0065]** The array of side-firing ultrasonic energy generation elements of the ultrasound transducer is employed to obtain a two-dimensional image of the selected portion of the side wall for visual inspection for purposes of detecting ultrasonically-detectable cortical breaches located therein.

**[0066]** The two positioning and the two array employment steps are performed without removing any of the ultrasound transducer or the distal end of the longitudinal shaft of the tactile feeler probe or the feeler probe tip of the longitudinal shaft of the tactile feeler probe from the pedicle screw pilot hole.

**[0067]** The instrument may be mounted and slid along a K-wire (not specifically shown) to guide the ultrasound and tactile feeler probes axially relative to the pedicle screw pilot hole during a minimally invasive surgical procedure. Alternatively, and/or in addition, the instrument may be mounted with respect to one or more guide wires other than a K-wire.

**[0068]** With reference to FIGS. 58-59, a further implementation according to the present disclosure is shown. Thus, a modified Jamshidi-style needle assembly 7001 may be employed with an ultrasound probe assembly in clinical applications, e.g., to detect/determine a breach in the cortical bone associated with pedicle screw placement. The Jamshidi-style needle assembly 7001 generally takes the form of a long hollow needle 7006 with a tapered cutting edge at a distal end thereof. A handle 7004 is mounted with respect to the needle 7006 and defines an aperture for receipt of an inner needle (not pictured) and ancillary element(s). In conventional use of a Jamshidi-style needle, the inner needle may be removed once a desired anatomical location is reached and a syringe may be introduced through the aperture formed in the handle for use in sampling tissue, e.g., bone marrow. However, in the exemplary implementation disclosed herein, after removal of the inner needle (not pictured), the aperture formed in handle 7004 of Jamshidi-style needle assembly 7001 is configured and dimensioned to receive an elongated ultrasound probe 7010 associated with ultrasound assembly 7002. In exemplary implementations, the ultrasound assembly 7002 includes a handle member 7008 that defines a fitting for connection to conventional cabling.

**[0069]** In use, the Jamshidi-style needle assembly 7001 is introduced to a desired clinical location, e.g., within cortical bone that has been pre-drilled for receipt of a pedicle screw, and the inner needle (not pictured) is removed. Ultrasound probe 7010 is then introduced through the aperture formed in the handle 7004 of the Jamshidi-style needle assembly 7001 for advantageous ultrasound detection of relevant information, e.g., a breach of the cortical bone. In exemplary implementations, needle 7006 is approximately 7.5 cm in length and the inner diameter of needle 7006 is approximately 3 mm. Alternative dimensions may be employed.

**[0070]** Although the systems, apparatus and methods have been described with respect to exemplary embodiments herein, it is apparent that modifications, variations, changes and/or enhancements may be made thereto. The invention is defined by the appended claims. For example, as an alternative to the use of a side-firing ultrasound transducer as described hereinabove, and/or in addition thereto, one or more end-firing ultrasound transducers, and/or 360 degree ultrasound transducers may be employed, whether mounted with respect to the distal end of the longitudinal shaft of the associated ultrasound probe, adjacent thereto, or otherwise, for use as desired by the surgical practitioner. Ultrasound probes and systems in accordance with the present disclosure may employ or embody one or more of a variety of modes of ultrasound, including but not necessarily limited to Ultrasound Mode A, Ultrasound Mode B, Ultrasound Mode M, Ultrasound DM Mode, as well as color and three-dimensional modes. Other instruments may be modularly attached in addition to, and/or in place of a tactile feeler probe, including but not limited to curettes, nerve hooks, Woodsons, and/or Murphey Balls. Accordingly, the present disclosure expressly encompasses all such modifications, variations, changes and/or enhancements.

## Claims

1. A medical diagnostic instrument (103; 301; 401), comprising:

a proximal handle (111) configured and dimensioned to permit an operator to manually grasp the instrument; an ultrasound probe (113; 305; 405) including a longitudinal shaft (115; 309; 409) extending distally from the handle and terminating in a distal end (117), and an ultrasound transducer (119) mounted with respect to the longitudinal shaft proximate the distal end thereof, the ultrasound transducer including an array of ultrasonic energy generation elements; and

a tactile feeler probe (121; 303; 403) mounted with respect to the ultrasound probe, the tactile feeler probe including a longitudinal shaft (123; 307; 407) mounted with respect to the longitudinal shaft of the ultrasound probe and extending distally beyond the distal end thereof, and a feeler probe tip (125) defined at a distal end

(127) of the longitudinal shaft of the tactile feeler probe;  
 wherein the ultrasound transducer and the distal end are cooperatively configured, oriented, and dimensioned to permit the operator to insert the ultrasound transducer and the distal end into a desired anatomical location to permit the operator to obtain thereat a corresponding two-dimensional image of the anatomical location for visual inspection by the operator for purposes of detecting ultrasonically-detectable anatomical properties;  
 wherein the feeler probe tip and the longitudinal shaft of the tactile feeler probe are cooperatively configured and dimensioned to permit the operator to insert the feeler probe tip and the longitudinal shaft of the tactile feeler probe into the desired anatomical location to permit the operator to perform thereat a tactile inspection of the selected anatomical location,  
 wherein the longitudinal shaft of the ultrasound probe defines a first longitudinal axis (207) along which the longitudinal shaft of the ultrasound probe extends distally from the handle, wherein the ultrasonic energy generation elements of the array thereof define a second longitudinal axis (209) along which the array of ultrasonic energy generation elements extends, wherein the second longitudinal axis is radially offset from the first longitudinal axis such that the first and second longitudinal axes define a first plane, wherein the handle includes a longitudinal shaft (215) extending proximally from the ultrasound probe and terminating in a proximal end (217), the longitudinal shaft of the handle defining a third longitudinal axis (219) along which the handle extends proximally from the ultrasound probe the third longitudinal axis being disposed in the first plane and wherein the tactile feeler probe is mounted with respect to the ultrasound probe such that the longitudinal shaft of the tactile feeler probe is supported, cantilever-style, by the longitudinal shaft of the ultrasound probe.

2. The medical diagnostic instrument of claim 1, wherein the desired anatomical location is a pedicle screw pilot hole formed in the spine of the human patient, and wherein the array of ultrasonic energy generation elements of the ultrasound transducer extends axially along, and is positionable against, a selected portion of a side wall of the pedicle screw pilot hole.

3. The medical diagnostic instrument of claim 2, wherein the feeler probe tip is positionable against the selected portion of the side wall of the pedicle screw pilot hole.

4. The medical diagnostic instrument of claim 1, wherein the longitudinal shaft of the tactile feeler probe defines at least a first longitudinal axis (201) along which the longitudinal shaft of the tactile feeler probe extends distally from the longitudinal shaft of the ultrasound probe, at least a second longitudinal axis (203) along which the longitudinal shaft of the tactile feeler probe extends distally to the feeler probe tip, and a bend (205) formed therebetween such that the first and second longitudinal axes collectively define a first plane.

5. The medical diagnostic instrument of claim 1, wherein the handle and the longitudinal shaft of the ultrasound probe are of unitary construction with respect to each other.

6. The medical diagnostic instrument of claim 1, wherein the handle includes a housing, and wherein the ultrasonic probe is mounted with respect to the handle such that the longitudinal shaft of the ultrasonic probe is supported, cantilever-style, by the handle housing.

7. The medical diagnostic instrument of claim 1, wherein at least some longitudinal overlap exists between the longitudinal shaft of the tactile feeler probe and the longitudinal shaft of the ultrasound probe.

8. The medical diagnostic instrument of claim 1, wherein the array of ultrasonic energy generation elements is side-firing and is one of a linear array and a phased array.

9. The medical diagnostic instrument of claim 1, wherein the feeler probe tip is a ball tip.

10. A medical diagnostic system (101) for use in conjunction with bone tissue, comprising:

a medical diagnostic instrument according to claim 3,

wherein the handle being disposable proximate an operator of the instrument and being further configured and dimensioned to manipulate the instrument relative to the spine of a human patient;  
 wherein the array of ultrasonic energy generation elements is an array of side-firing ultrasonic energy generation elements;  
 wherein the ultrasonically-detectable anatomical properties are ultrasonically-detectable cortical breaches;

the feeler probe tip and the longitudinal shaft of the tactile feeler probe being cooperatively configured and dimensioned to permit the operator to perform thereat a tactile inspection of the selected portion of the side wall of the pedicle screw pilot hole for purposes of detecting manually-detectable cortical breaches located therein; and

a first cable assembly (105) for carrying electrical signals to and from the ultrasound transducer in accordance with an ultrasonic imaging mode of use of the instrument, the cable assembly including a proximal end including a first electrical connector (131) for connecting the instrument to a corresponding ultrasound console (107) and current carrying wires extending distally from the electrical connector, through the longitudinal shaft of the ultrasound probe and to the ultrasound transducer;

an ultrasound console (107) including a processor (133) for controlling the medical diagnostic instrument, a display (135) for displaying two-dimensional ultrasonic images obtained therefrom by an operator thereof, and a port (137) for receiving a corresponding cable connector; and

a second cable assembly (109) for carrying electrical signals to and from the ultrasound console, the second cable assembly including a second electrical connector (139) coupled to the port associated with the ultrasound console, a third electrical connector (141) coupled to the first electrical connector, and current carrying wires extending therebetween.

11. The medical diagnostic system of claim 10, wherein the connection between the third electrical connector of the second cable assembly and the first electrical connector of the first cable assembly is an umbilical connection between a disposable portion (143) of the medical diagnostic system including the medical diagnostic instrument, and a non-disposable portion (145) of the medical diagnostic system including the ultrasound console and the second cable assembly.

## Patentansprüche

### 1. Medizinisches Diagnoseinstrument (103; 301; 401), aufweisend:

einen proximalen Griff (111), der konfiguriert und dimensioniert ist, einem Bediener zu ermöglichen, das Instrument manuell zu greifen;

eine Ultraschallsonde (113; 305; 405), welche einen länglichen Schaft (115; 309; 409), der sich distal von dem Griff erstreckt und in einem distalen Ende (117) endet, und einen Ultraschallwandler (119) aufweist, der bezüglich des länglichen Schaftes proximal des distalen Endes hiervon angebracht ist, wobei der Ultraschallwandler ein Array von Ultraschall-Energieerzeugungselementen aufweist; und

eine taktile Tastfühlersonde (121; 303; 403), welcher bezüglich der Ultraschallsonde angebracht ist, wobei die Tastfühlersonde einen länglichen Schaft (123; 307; 407), der hinsichtlich des länglichen Schaftes der Ultraschallsonde angebracht ist und sich distal jenseits des distalen Endes hiervon erstreckt, und eine Tastfühlersondenspitze (125) aufweist, welche an einem distalen Ende (127) des länglichen Schaftes der Tastfühlersonde definiert ist;

wobei der Ultraschallwandler und das distale Ende zusammenwirkend konfiguriert, orientiert und dimensioniert sind, um dem Bediener zu ermöglichen, den Ultraschallwandler und das distale Ende in eine gewollte anatomische Stelle einzuführen, um dem Bediener dort zu ermöglichen, ein entsprechendes zweidimensionales Bild der anatomischen Stelle zur visuellen Überprüfung durch den Bediener zu Zwecken des Feststellens von ultraschall-detektierbaren anatomischen Eigenschaften zu erhalten;

wobei die Tastfühlersondenspitze und der längliche Schaft der taktilen Fühlersonde zusammenwirkend konfiguriert und dimensioniert sind, um dem Bediener zu ermöglichen, die Tastfühlersondenspitze und den länglichen Schaft der taktilen Fühlersonde in die gewollte anatomische Stelle einzuführen, um dem Bediener zu ermöglichen, dort eine taktile Überprüfung der ausgewählten anatomischen Stelle durchzuführen, wobei der längliche Schaft der Ultraschallsonde eine erste Längsachse (207) definiert, entlang welcher sich der längliche Schaft der Ultraschallsonde distal von dem Griff erstreckt,

wobei die Ultraschall-Energieerzeugungselemente des Arrays hiervon eine zweite Längsachse (209) definieren, entlang welcher sich das Array der Ultraschall-Energieerzeugungselemente erstreckt, wobei die zweite Längsachse gegenüber der ersten Längsachse radial versetzt ist, so dass die erste und zweite Längsachse eine erste Ebene definieren, wobei der Griff einen länglichen Schaft (215) aufweist, welcher sich proximal von der Ultraschallsonde erstreckt und in einem proximalen Ende (217) endet, wobei der längliche Schaft des Griffes eine dritte Längsachse (219) definiert, entlang welcher sich der Griff proximal

## EP 2 427 117 B1

von der Ultraschallsonde erstreckt, wobei die dritte Längsachse in der ersten Achse angeordnet ist und wobei der taktile Fühler-sonde hinsichtlich der Ultraschallsonde angebracht ist, so dass der längliche Schaft der taktilen Fühler-sonde kragbalkenartig durch den länglichen Schaft der Ultraschallsonde gestützt wird.

- 5     **2.** Medizinisches Diagnoseinstrument gemäß Anspruch 1, wobei die gewollte anatomische Stelle eine Führungsbohrung für eine Pedikelschraube ist, welche in der Wirbelsäule des menschlichen Patienten ausgebildet ist und wobei sich das Array der Ultraschall-Energieerzeugungselemente des Ultraschallwandlers axial entlang eines ausgewählten Abschnittes einer Seitenwand der Führungsbohrung für eine Pedikelschraube ausdehnt und gegenüber positionierbar ist.
- 10     **3.** Medizinisches Diagnoseinstrument gemäß Anspruch 2, wobei die Tastfühlersondenspitze gegenüber dem ausgewählten Abschnitt der Seitenwand der Führungsbohrung für eine Pedikelschraube positionierbar ist.
- 15     **4.** Medizinisches Diagnoseinstrument nach Anspruch 1, wobei der längliche Schaft der taktilen Fühler-sonde mindestens eine erste Längsachse (201) definiert, entlang welcher der längliche Schaft der taktilen Fühler-sonde sich distal von dem länglichen Schaft der Ultraschallsonde erstreckt, wobei mindestens eine zweite Längsachse (203), entlang welcher sich der längliche Schaft der taktilen Fühler-sonde distal zur Tastfühlersondenspitze erstreckt, und eine Biegung (205), so dazwischen geformt, dass die erste und zweite Längsachse gemeinsam eine erste Ebene definieren.
- 20     **5.** Medizinisches Diagnoseinstrument gemäß Anspruch 1, wobei der Griff und der längliche Schaft des Ultraschallwandlers in Bezug aufeinander von einstückig Bauform sind.
- 25     **6.** Medizinisches Diagnoseinstrument nach Anspruch 1, wobei der Griff ein Gehäuse aufweist, und wobei die Ultraschallsonde in Bezug auf den Griff so angebracht ist, dass der längliche Schaft der Ultraschallsonde kragbalkenartig durch das Griffgehäuse gestützt wird.
- 30     **7.** Medizinisches Diagnoseinstrument nach Anspruch 1, wobei zumindest etwas longitudinale Überschneidung zwischen dem länglichen Schaft der taktilen Fühler-sonde und dem länglichen Schaft der Ultraschallsonde existiert.
- 35     **8.** Medizinisches Diagnoseinstrument nach Anspruch 1, wobei das Array von Ultraschall-Energieerzeugungselementen längsstrahlend und eines von einem Linearschallwandler oder einem Sektorschallwandler ist.
- 40     **9.** Medizinisches Diagnoseinstrument nach Anspruch 1, wobei die Tastfühlersondenspitze eine Kugelspitze ist.
- 45     **10.** Medizinisches Diagnosesystem (101) zur Verwendung in Verbindung mit Knochengewebe, aufweisend:  
medizinisches Diagnoseinstrument gemäß Anspruch 3,  
wobei der Griff proximal eines Bedieners des Instruments positionierbar ist und weiter konfiguriert und dimensioniert ist, um das Instrument relativ zur Wirbelsäule eines menschlichen Patienten zu bedienen;  
wobei das Array der Ultraschall-Energieerzeugungselemente ein Array von längsstrahlenden Ultraschall-Energieerzeugungselementen ist;  
wobei die ultraschall-detektierbaren anatomischen Eigenschaften ultraschall-detektierbare kortikale Brüche sind;  
wobei die Tastfühlerspitze und der längliche Schaft der taktilen Fühler-sonde zusammenwirkend konfiguriert und dimensioniert sind, um dem Bediener zu ermöglichen, dort eine taktile Überprüfung des ausgewählten Abschnittes der Seitenwand der Führungsbohrung für eine Pedikelschraube zu Zwecken des Feststellens von sich darin befindlichen manuell detektierbaren kortikalen Brüchen auszuführen; und  
eine erste Kabelanordnung (105) zum Übertragen von elektrischen Signalen zu und von der Ultraschallsonde in Abhängigkeit von einem verwendeten Ultraschallbildgebungsmodus des Instruments, wobei die Kabelanordnung ein proximales Ende aufweist, welches einen ersten elektrischen Steckverbinder (131) zum Anschließen des Instruments an eine entsprechende Ultraschall-Konsole (107) und stromführende Kabel aufweist, welche sich distal von dem elektrischen Steckverbinder durch den länglichen Schaft der Ultraschallsonde und zum Ultraschallwandler erstrecken,  
eine Ultraschall-Konsole (107), welche einen Prozessor (133) zum Kontrollieren des medizinischen Diagnoseinstruments aufweist,  
ein Display (135) zum Anzeigen von davon durch einen Bediener hiervon erhaltenen zweidimensionalen Ultraschallbildern und einen Anschluss (137) zum Aufnehmen einer entsprechenden Kabelverbindung; und
- 50
- 55

eine zweite Kabelanordnung (109) zum Übertragen von elektrischen Signalen zu und von der Ultraschall-Konsole,  
 wobei die zweite Kabelanordnung einen zweiten elektrischen Steckverbinder (139) aufweist, welcher mittels  
 eines Anschlusses mit der Ultraschall-Konsole gekoppelt ist,  
 einen dritten elektrischen Steckverbinder (141), welcher mit dem ersten elektrischen Steckverbinder gekoppelt  
 ist,

und stromführende Kabel, welche sich dazwischen erstrecken.

11. Medizinisches Diagnoseinstrument nach Anspruch 10, wobei die Verbindung zwischen dem dritten elektrischen Steckverbinder der zweiten Kabelanordnung und dem ersten elektrischen Steckverbinder eine Versorgungsverbindung zwischen einem abnehmbaren Teil (143) des medizinischen Diagnosesystems, welches das medizinische Diagnoseinstrument aufweist, und einem nicht abnehmbaren Teil (145) des medizinischen Diagnosesystems ist, welcher die Ultraschall-Konsole und die zweite Kabelanordnung aufweist.

## Revendications

1. Instrument de diagnostic médical (103 ; 301 ; 401), comprenant :

une poignée proximale (111) configurée et dimensionnée pour permettre à un opérateur de saisir manuellement l'instrument ;

une sonde à ultrasons (113 ; 305 ; 405) incluant une tige longitudinale (115 ; 309 ; 409) s'étendant distalement depuis la poignée et se terminant dans une extrémité distale (117), et un transducteur à ultrasons (119) monté par rapport à la tige longitudinale à proximité de son extrémité distale, le transducteur à ultrasons incluant un réseau d'éléments générateurs d'énergie ultrasonique ; et

une sonde à palpeur tactile (121 ; 303 ; 403) montée par rapport à la sonde à ultrasons, la sonde à palpeur tactile incluant une tige longitudinale (123 ; 307 ; 407) montée par rapport à la tige longitudinale de la sonde à ultrasons et s'étendant distalement au-delà de son extrémité distale, et une pointe de sonde à palpeur (125) définie à une extrémité distale (127) de la tige longitudinale de la sonde à palpeur tactile ;

dans lequel le transducteur à ultrasons et l'extrémité distale sont configurés, orientés, et dimensionnés de façon coopérative pour permettre à l'opérateur d'insérer le transducteur à ultrasons et l'extrémité distale dans un site anatomique souhaité pour permettre à l'opérateur d'obtenir à ce niveau une image bidimensionnelle correspondante du site anatomique pour une inspection visuelle par l'opérateur afin de détecter des propriétés anatomiques détectables par ultrasons ;

dans lequel la pointe de sonde à palpeur et la tige longitudinale de la pointe de sonde à palpeur sont configurées et dimensionnées de façon coopérative pour permettre à l'opérateur d'insérer la pointe de sonde à palpeur et la tige longitudinale de la sonde à palpeur tactile dans le site anatomique souhaité pour permettre à l'opérateur de réaliser à ce niveau une inspection tactile du site anatomique sélectionné,

dans lequel la tige longitudinale de la sonde à ultrasons définit un premier axe longitudinal (207) le long duquel la tige longitudinale de la sonde à ultrasons s'étend distalement depuis la poignée,

dans lequel les éléments générateurs d'énergie ultrasonique de leur réseau définissent un deuxième axe longitudinal (209) le long duquel le réseau d'éléments générateurs d'énergie ultrasonique s'étend, dans lequel le deuxième axe longitudinal est décalé radialement du premier axe longitudinal de sorte que les premier et deuxième axes longitudinaux définissent un premier plan, dans lequel la poignée inclut une tige longitudinale (215) s'étendant sur le plan proximal depuis la sonde à ultrasons et se terminant dans une extrémité proximale (217), la tige longitudinale de la poignée définissant un troisième axe longitudinal (219) le long duquel la poignée s'étend proximale depuis la sonde à ultrasons, le troisième axe étant disposé dans le premier plan et

dans lequel la sonde à palpeur tactile est montée par rapport à la sonde à ultrasons de sorte que la tige longitudinale de la sonde à palpeur tactile est supportée, dans le style d'une travée en porte-à-faux, par la tige longitudinale de la sonde à ultrasons.

2. Instrument de diagnostic médical selon la revendication 1, dans lequel le site anatomique souhaité est un trou de guidage d'une vis pédiculaire formé dans la colonne vertébrale du patient humain, et dans lequel le réseau d'éléments générateurs d'énergie ultrasonique du transducteur à ultrasons s'étend axialement le long, et peut être positionné contre une partie sélectionnée d'une paroi latérale du trou de guidage de vis pédiculaire.

3. Instrument de diagnostic médical selon la revendication 2, dans lequel la pointe de sonde à palpeur peut être

positionnée contre la partie sélectionnée de la paroi latérale du trou de guidage de vis pédiculaire.

- 5
4. Instrument de diagnostic médical selon la revendication 1, dans lequel la tige longitudinale de la sonde à palpeur tactile définit au moins un premier axe longitudinal (201) le long duquel la tige longitudinale de la sonde à palpeur tactile s'étend distalement depuis la tige longitudinale de la sonde à ultrasons, au moins un second axe longitudinal (203) le long duquel la tige longitudinale de la sonde à palpeur tactile s'étend distalement jusqu'à la pointe de sonde de palpeur, et un coude (205) formé entre eux de sorte que les premier et second axes longitudinaux définissent collectivement un premier plan.
- 10
5. Instrument de diagnostic médical selon la revendication 1, dans lequel la poignée et la tige longitudinale de la sonde à ultrasons sont de construction unitaire l'une par rapport à l'autre.
- 15
6. Instrument de diagnostic médical selon la revendication 1, dans lequel la poignée inclut un logement et dans lequel la sonde à ultrasons est montée par rapport à la poignée de sorte que la tige longitudinale de la sonde à ultrasons est supportée, dans le style d'une travée en porte-à-faux, par le logement de poignée.
- 20
7. Instrument de diagnostic médical selon la revendication 1, dans lequel au moins un certain chevauchement longitudinal existe entre la tige longitudinale de la sonde à palpeur tactile et la tige longitudinale de la sonde à ultrasons.
- 25
8. Instrument de diagnostic médical selon la revendication 1, dans lequel le réseau des éléments générateurs d'énergie ultrasonique est à émission latérale et est l'un parmi un réseau linéaire et un réseau à commande de phase.
- 30
9. Instrument de diagnostic médical selon la revendication 1, dans lequel la pointe de la sonde de palpeur est une pointe à bille.
- 35
10. Système de diagnostic médical (101) pour une utilisation en association avec un tissu osseux, comprenant :
- 40
- un instrument de diagnostic médical selon la revendication 3, dans lequel la poignée peut être disposée à proximité d'un opérateur de l'instrument et étant en outre configurée et dimensionnée pour manipuler l'instrument par rapport à la colonne vertébrale d'un patient humain ; dans lequel le réseau d'éléments générateurs d'énergie par ultrasons est un réseau d'éléments générateurs d'énergie ultrasonique à émission latérale ; dans lequel les propriétés anatomiques détectables par ultrasons sont des fractures corticales détectables par ultrasons ;
- 45
- la pointe de la sonde de palpeur et la tige longitudinale de la sonde à palpeur tactile étant configurées et dimensionnées de façon coopérative pour permettre à l'opérateur de réaliser à ce niveau une inspection tactile de la partie sélectionnée de la paroi latérale du trou de guidage de vis pédiculaire afin de détecter des fractures corticales détectables manuellement situées dans celle-ci ; et
- 50
- un premier assemblage de câbles (105) pour transporter des signaux électriques jusqu'à et depuis le transducteur à ultrasons selon un mode d'imagerie à ultrasons d'utilisation de l'instrument, l'assemblage de câbles incluant une extrémité proximale incluant un premier connecteur électrique (131) pour une connexion de l'instrument à une console à ultrasons correspondante (107) et des fils transportant un courant s'étendant distalement depuis le connecteur électrique au travers de la tige longitudinale de la sonde à ultrasons et jusqu'au transducteur à ultrasons ;
- 55
- une console à ultrasons (107) incluant un processeur (133) pour commander l'instrument de diagnostic médical, un écran (135) pour afficher des images ultrasonores bidimensionnelles obtenues à partir de celui-ci par un opérateur de celui-ci, et un port (137) pour recevoir un connecteur de câble correspondant ; et
- un second assemblage de câbles (109) pour transporter des signaux électriques depuis et jusqu'à la console à ultrasons,
- le second assemblage de câbles incluant un deuxième connecteur électrique (139) couplé au port associé à la console à ultrasons,
- un troisième connecteur électrique (141) couplé au premier connecteur électrique et des fils transportant le courant s'étendant entre eux.
11. Système de diagnostic médical selon la revendication 10, dans lequel la connexion entre le troisième connecteur électrique du second assemblage de câbles et le premier connecteur électrique du premier assemblage de câbles est une connexion ombilicale entre une partie jetable (143) du système de diagnostic médical incluant l'instrument de diagnostic médical et une partie non jetable (145) du système de diagnostic médical incluant la console à ultrasons

et le second assemblage de câbles.

5

10

15

20

25

30

35

40

45

50

55

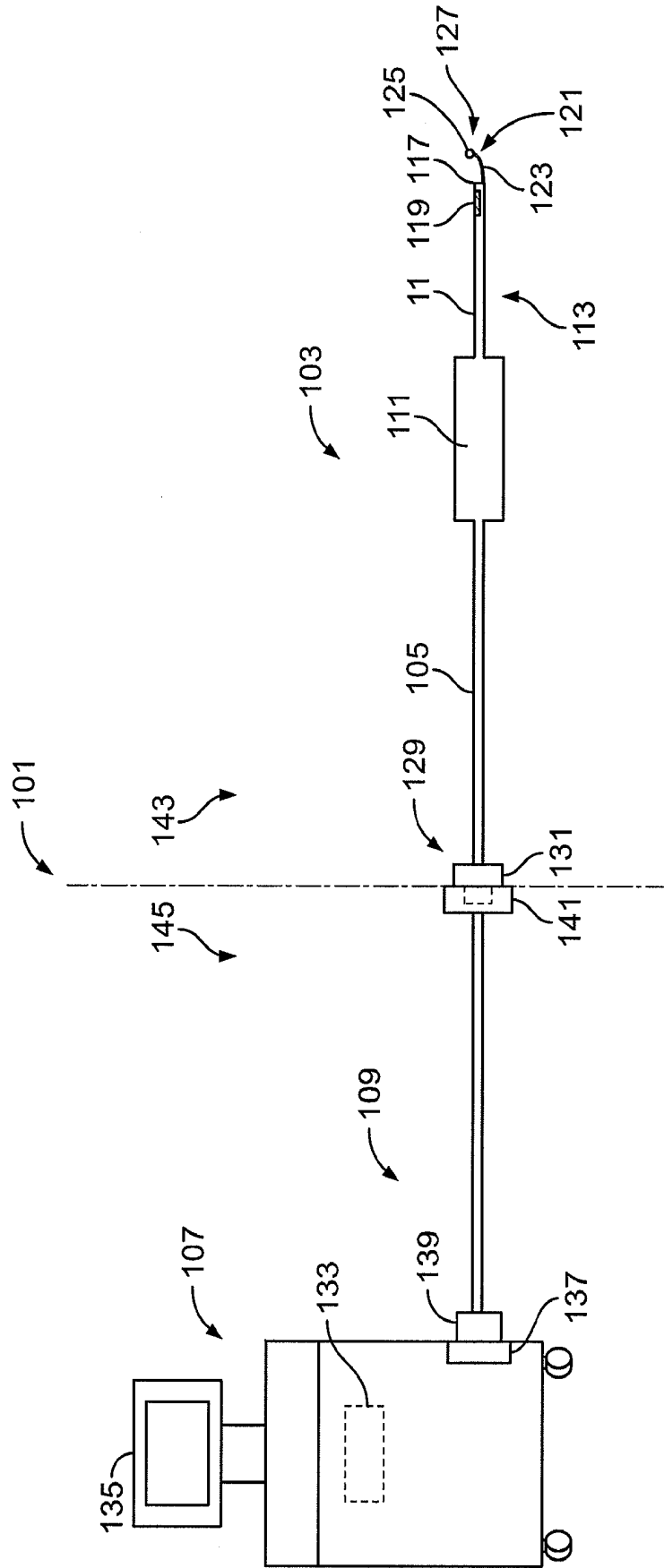

FIG. 1

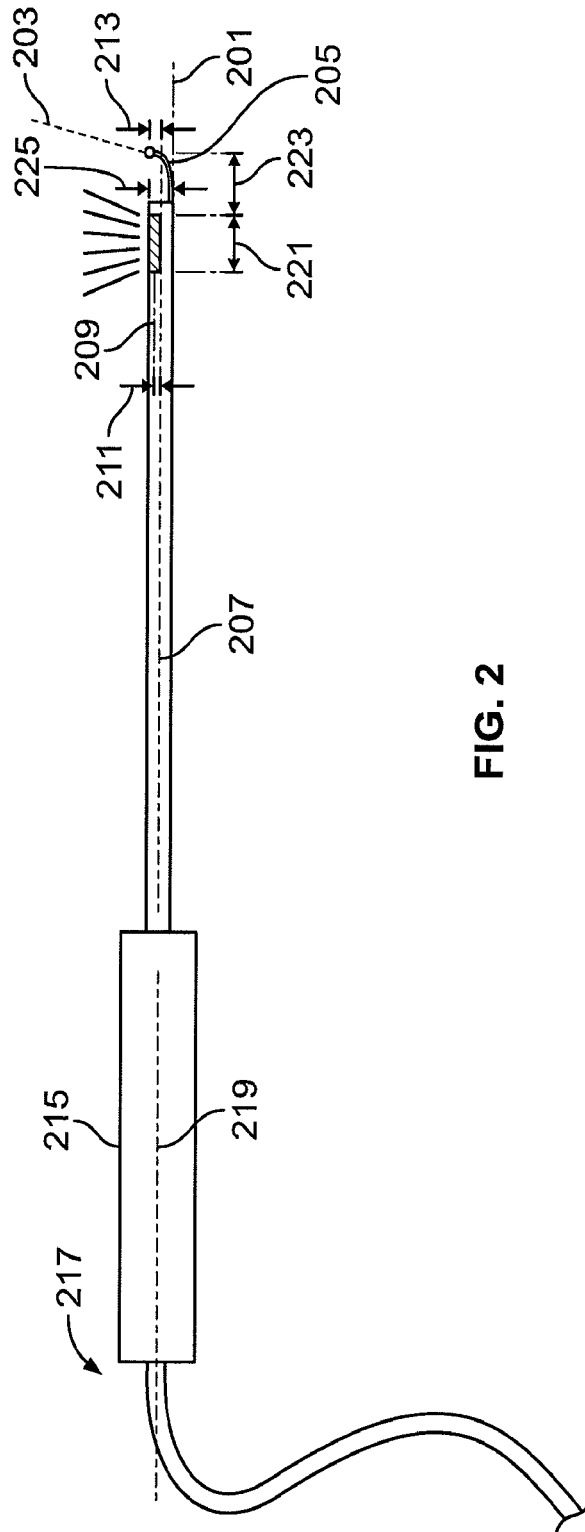

FIG. 2

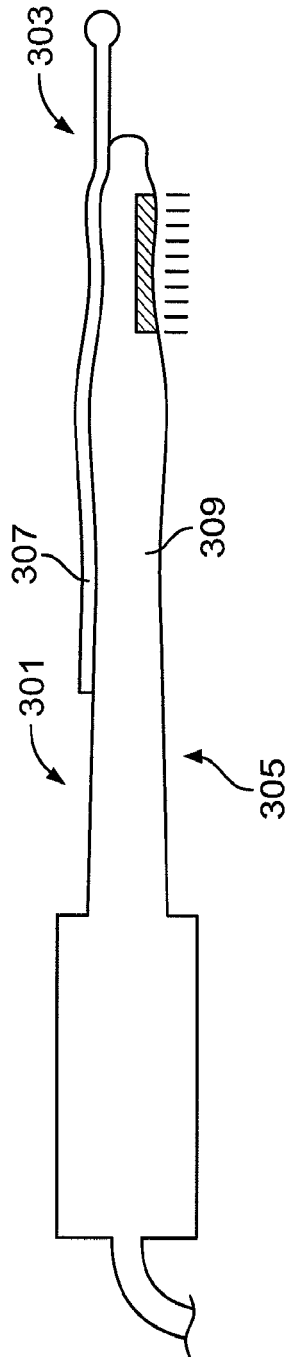

FIG. 3

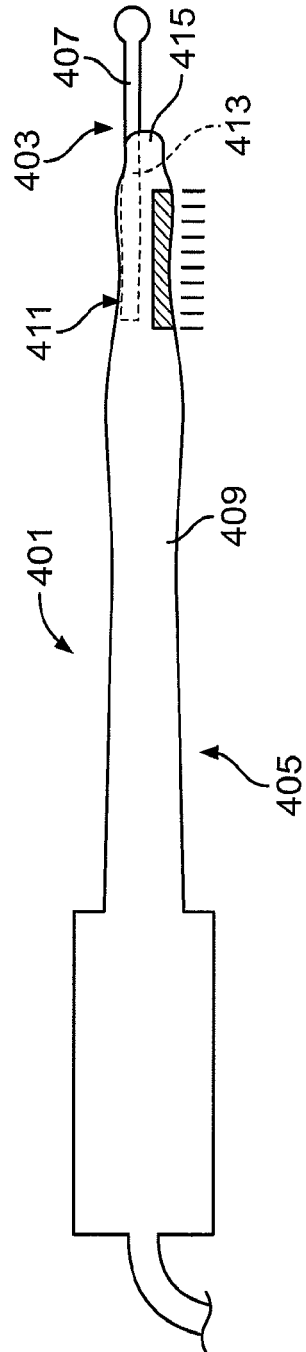

FIG. 4

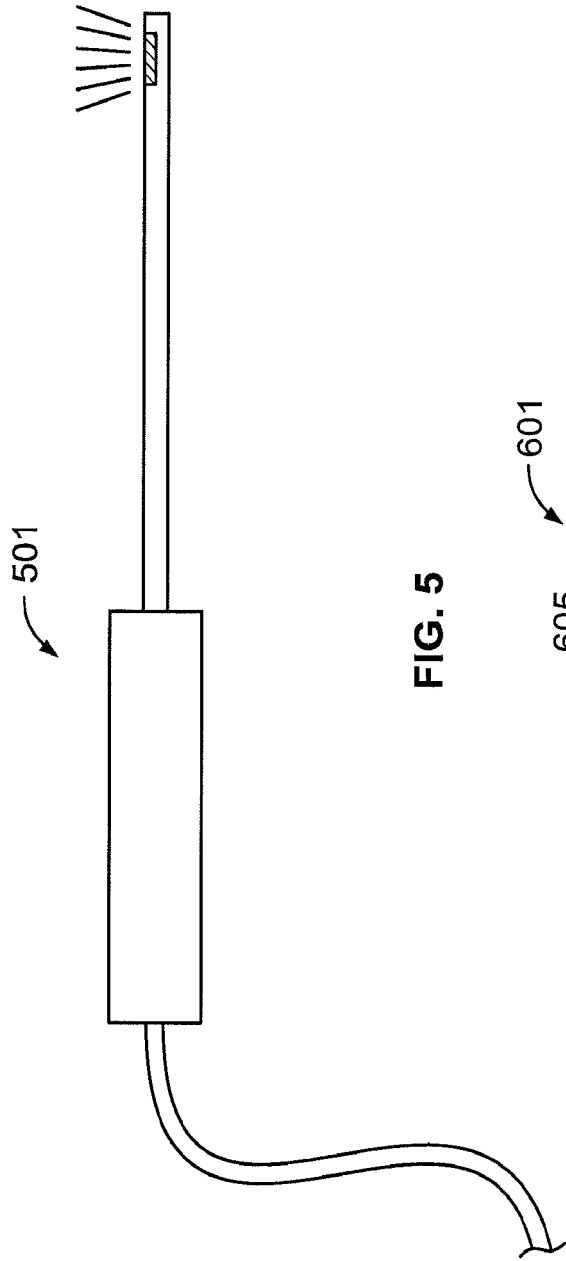

FIG. 5

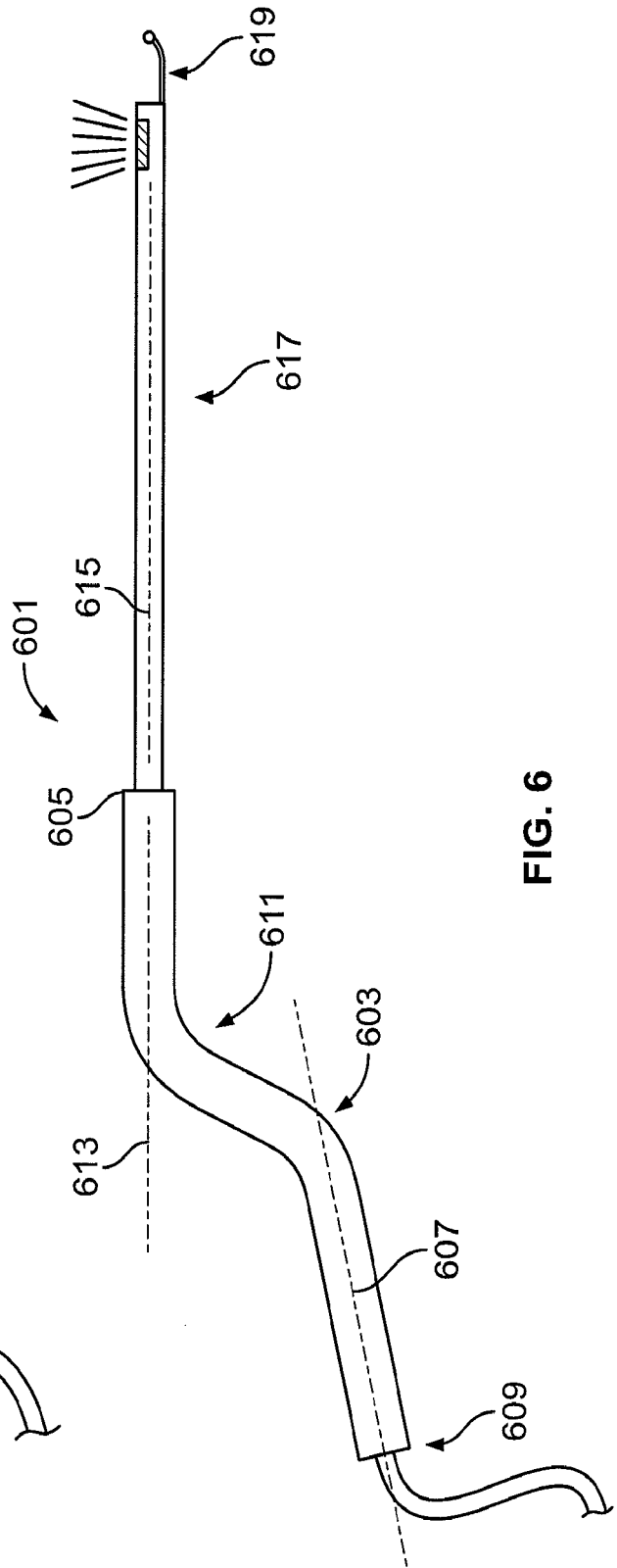

FIG. 6

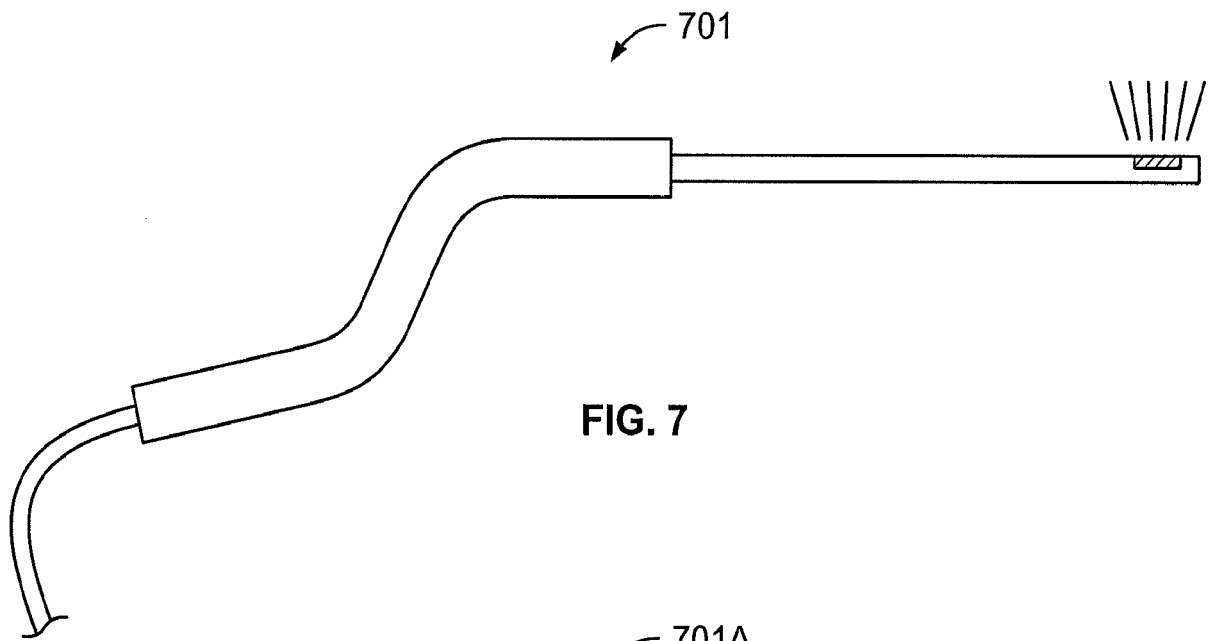

FIG. 7

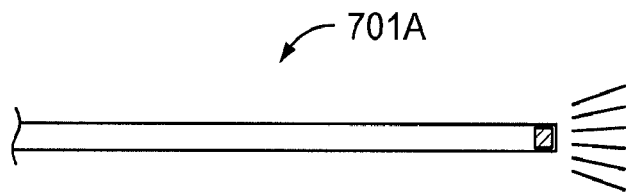
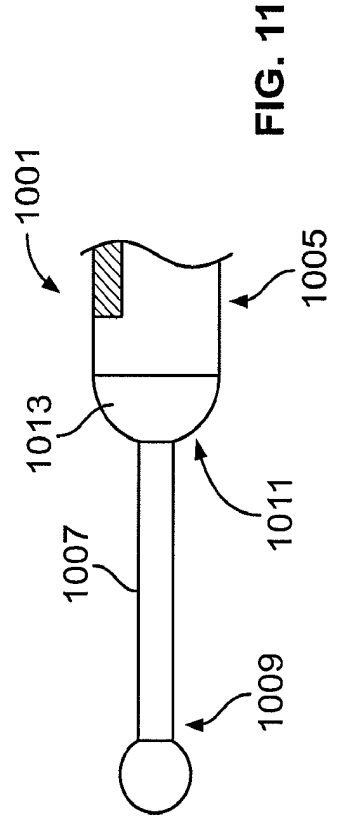
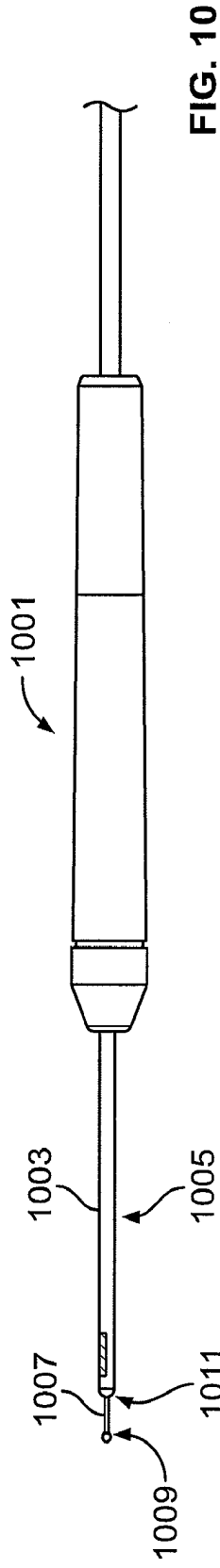
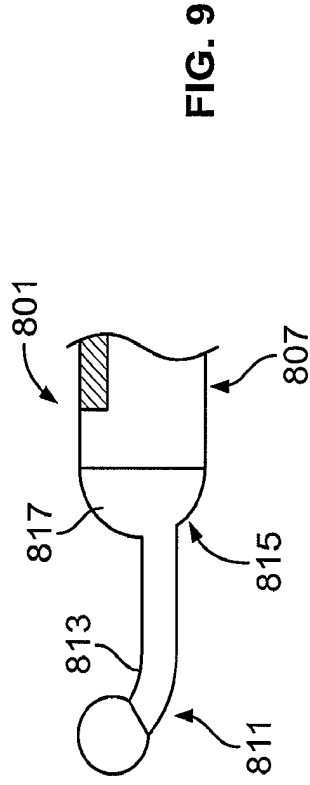
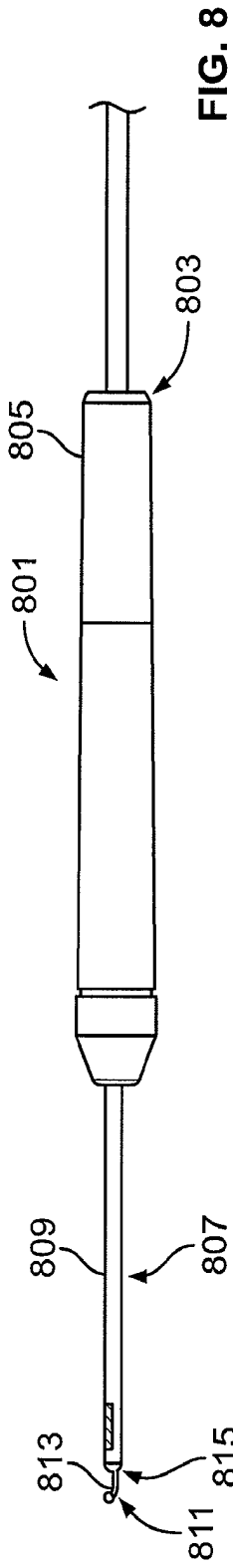

FIG. 7A



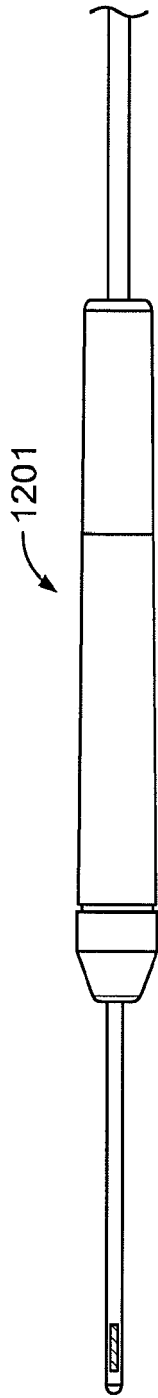

FIG. 12

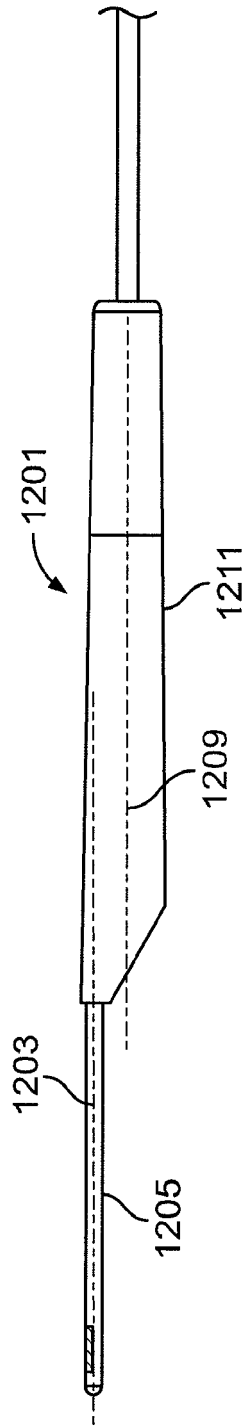

FIG. 13



FIG. 14

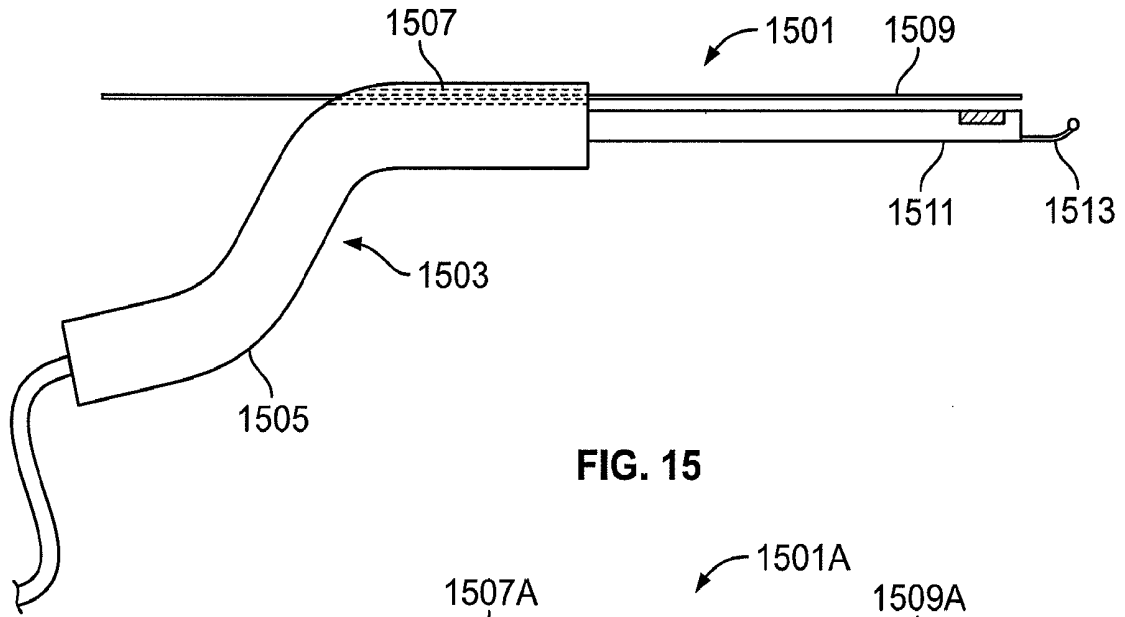

FIG. 15

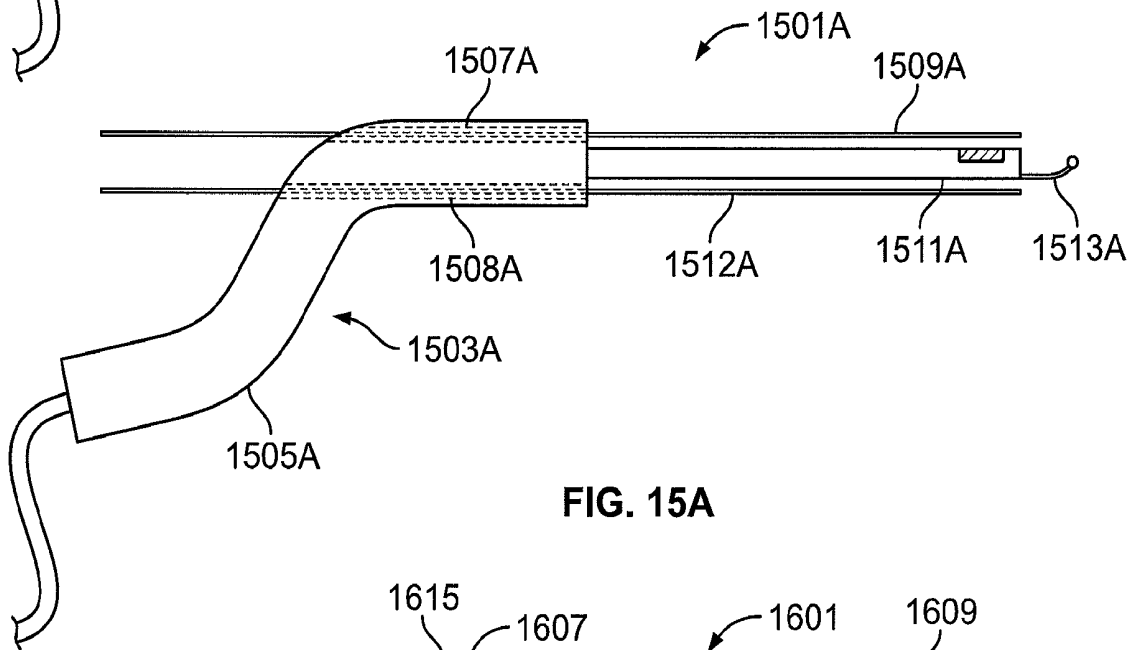

FIG. 15A

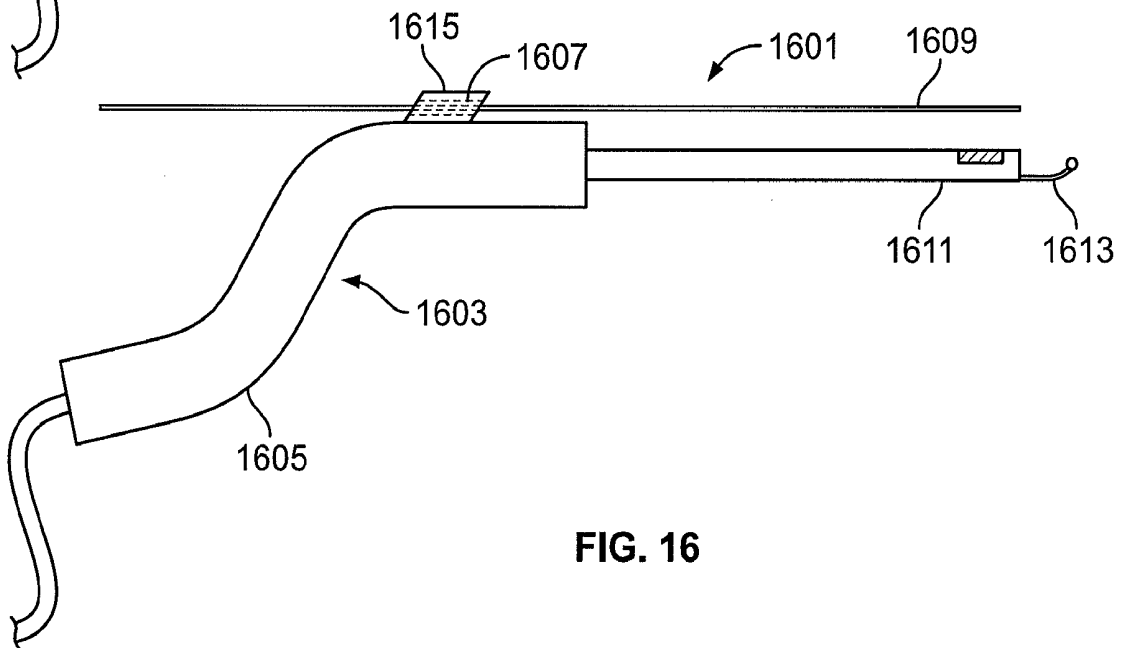

FIG. 16

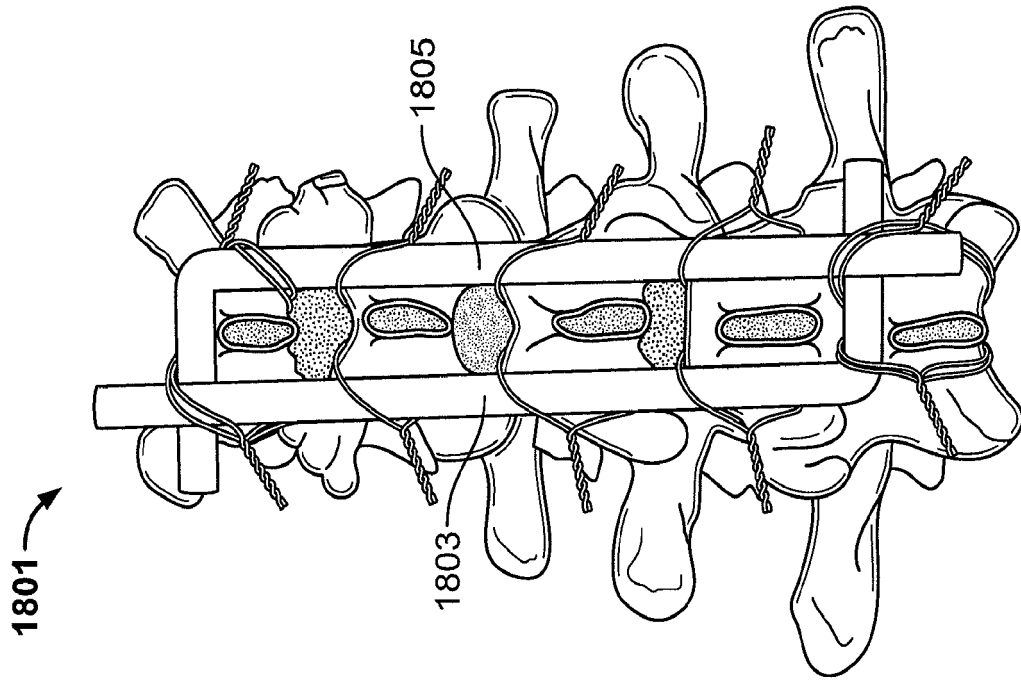

FIG. 18

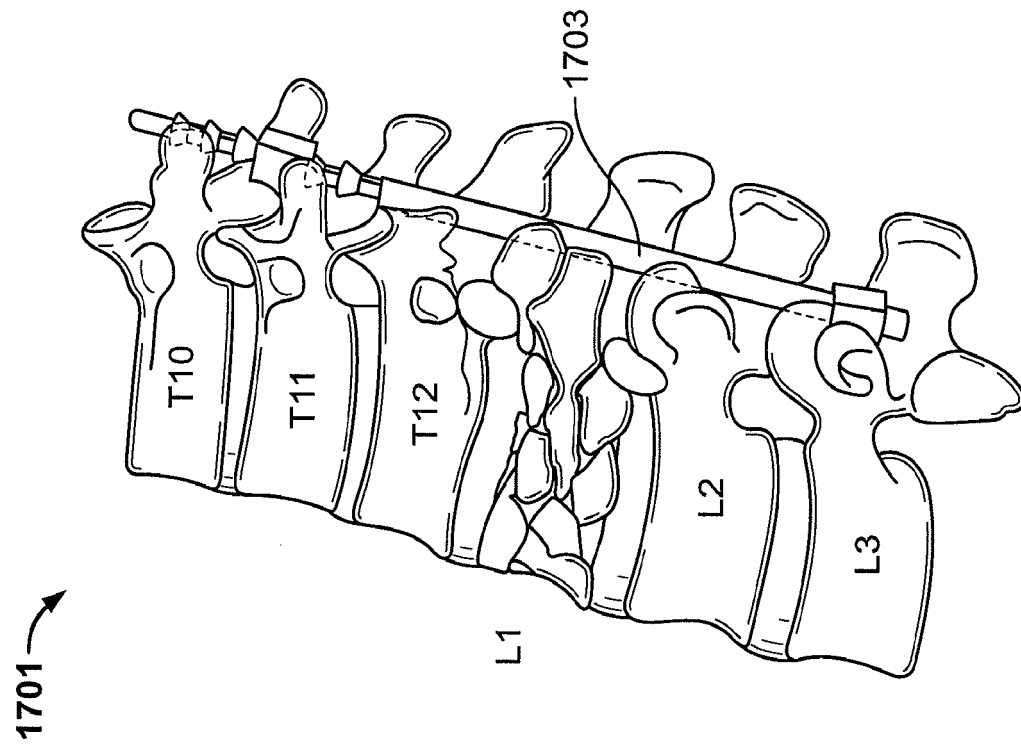

FIG. 17

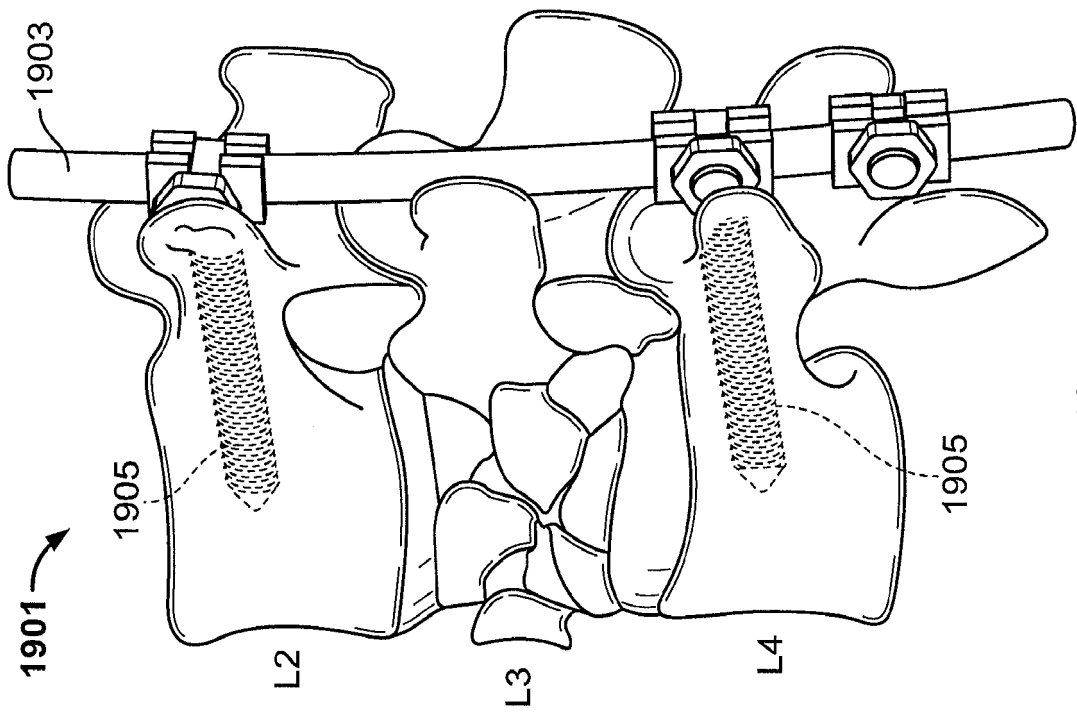

FIG. 19

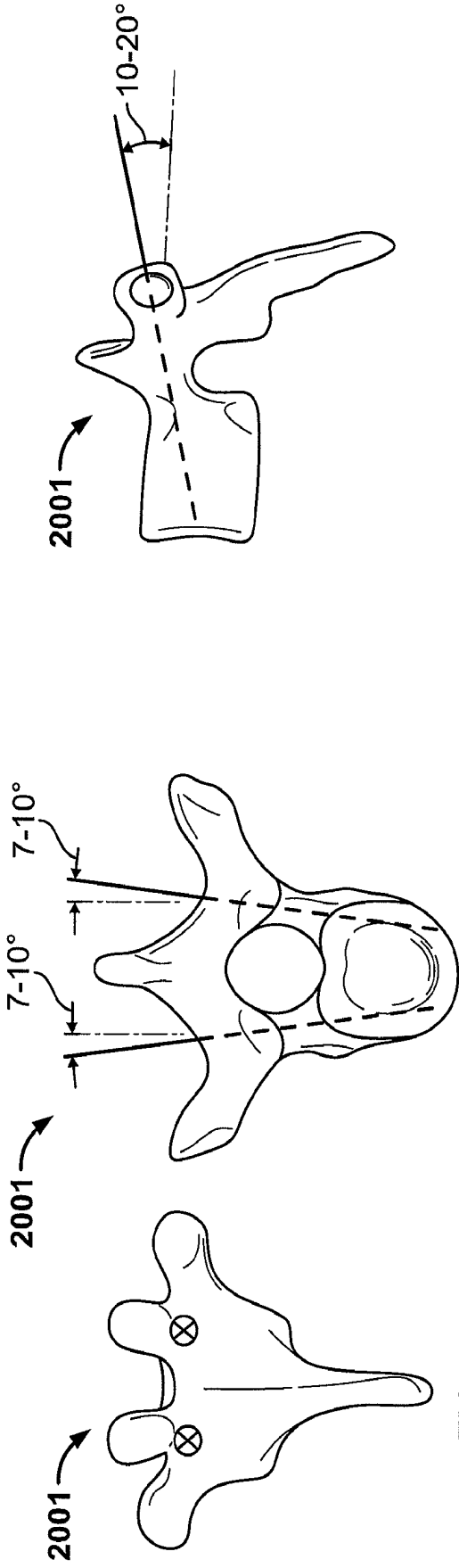

FIG. 20

FIG. 21

FIG. 22

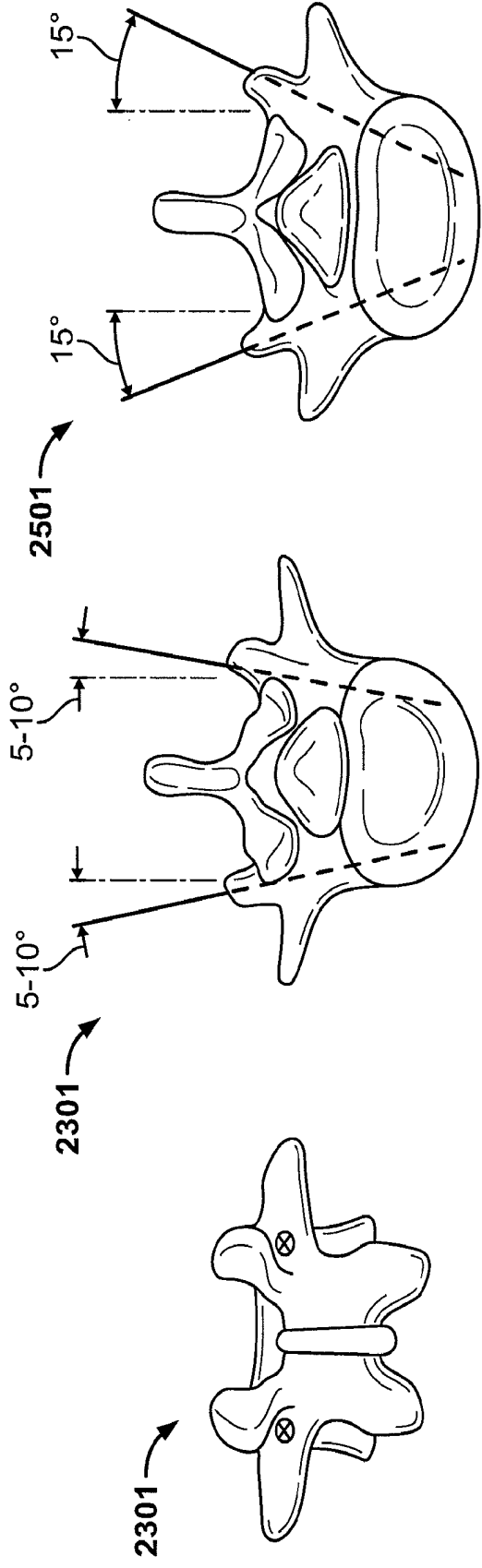

FIG. 23

FIG. 24

FIG. 25

L 2/3 Listhesis



FIG. 26

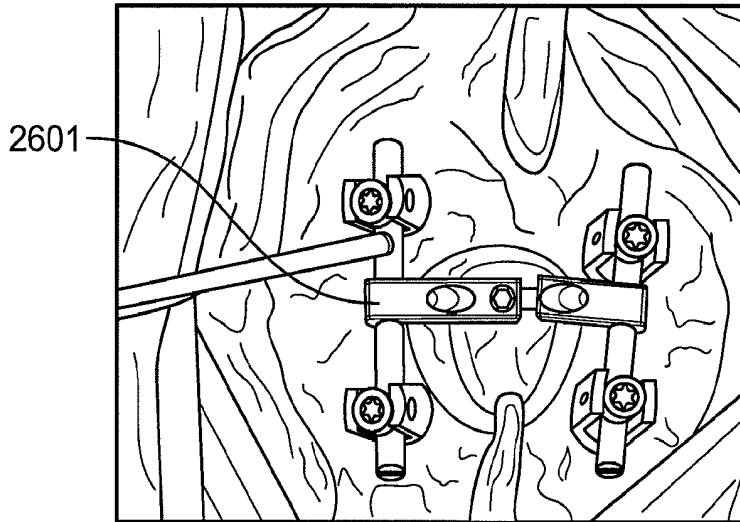

FIG. 27

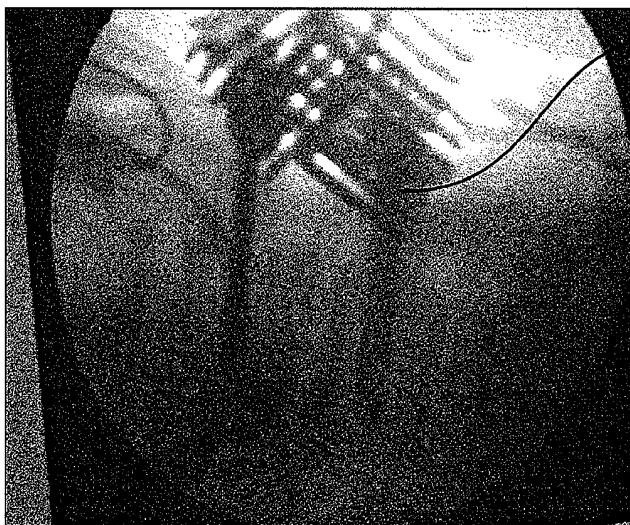

FIG. 28

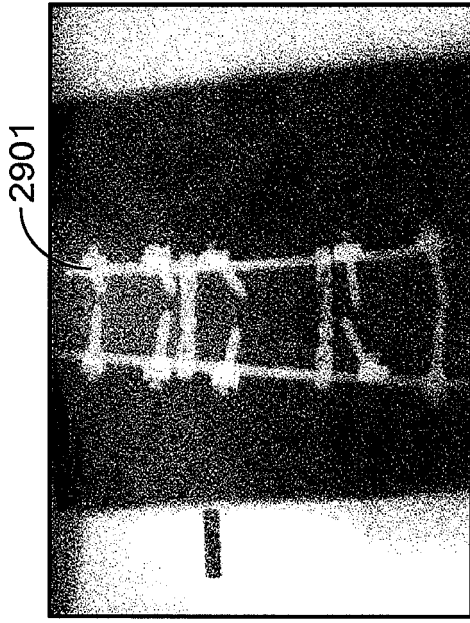

FIG. 30



FIG. 31

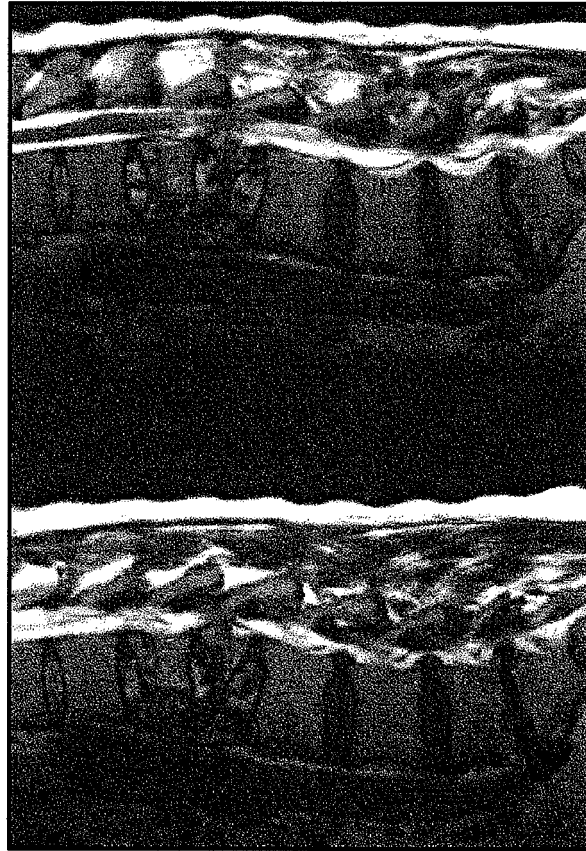

FIG. 29



**FIG. 33**



**3201**  
**FIG. 34**



Progressive Kyphosis  
Pain  
Paraparesis

**FIG. 32**



FIG. 37

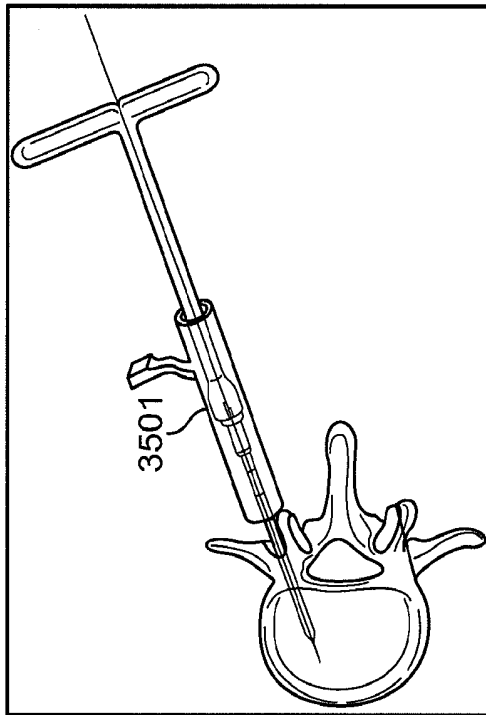

FIG. 36



FIG. 35

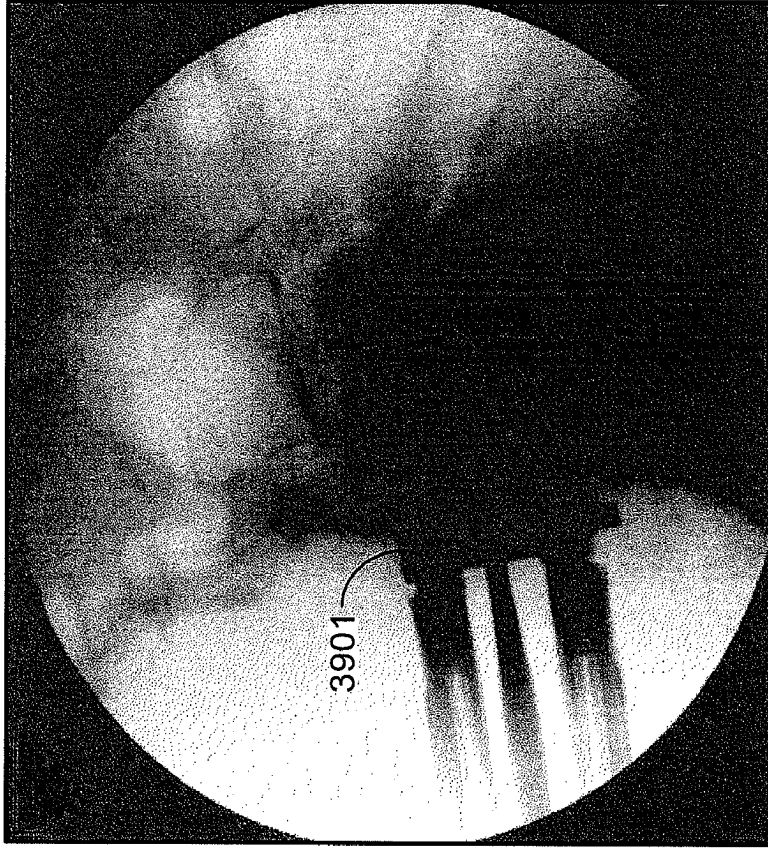

FIG. 39

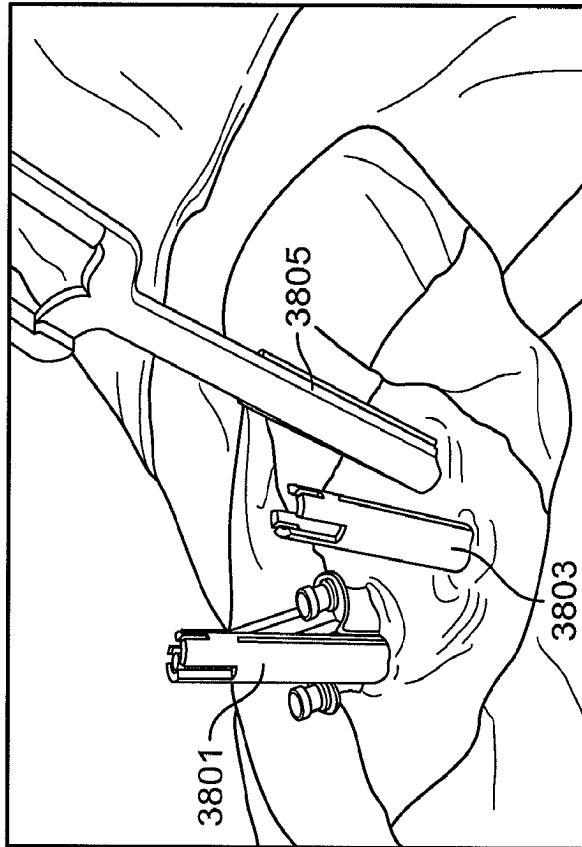

FIG. 38

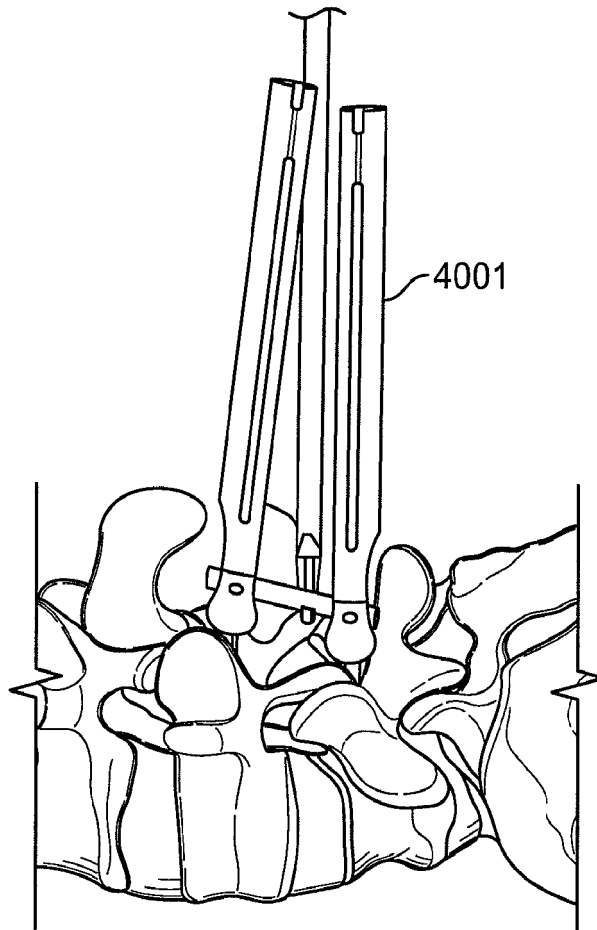

FIG. 40

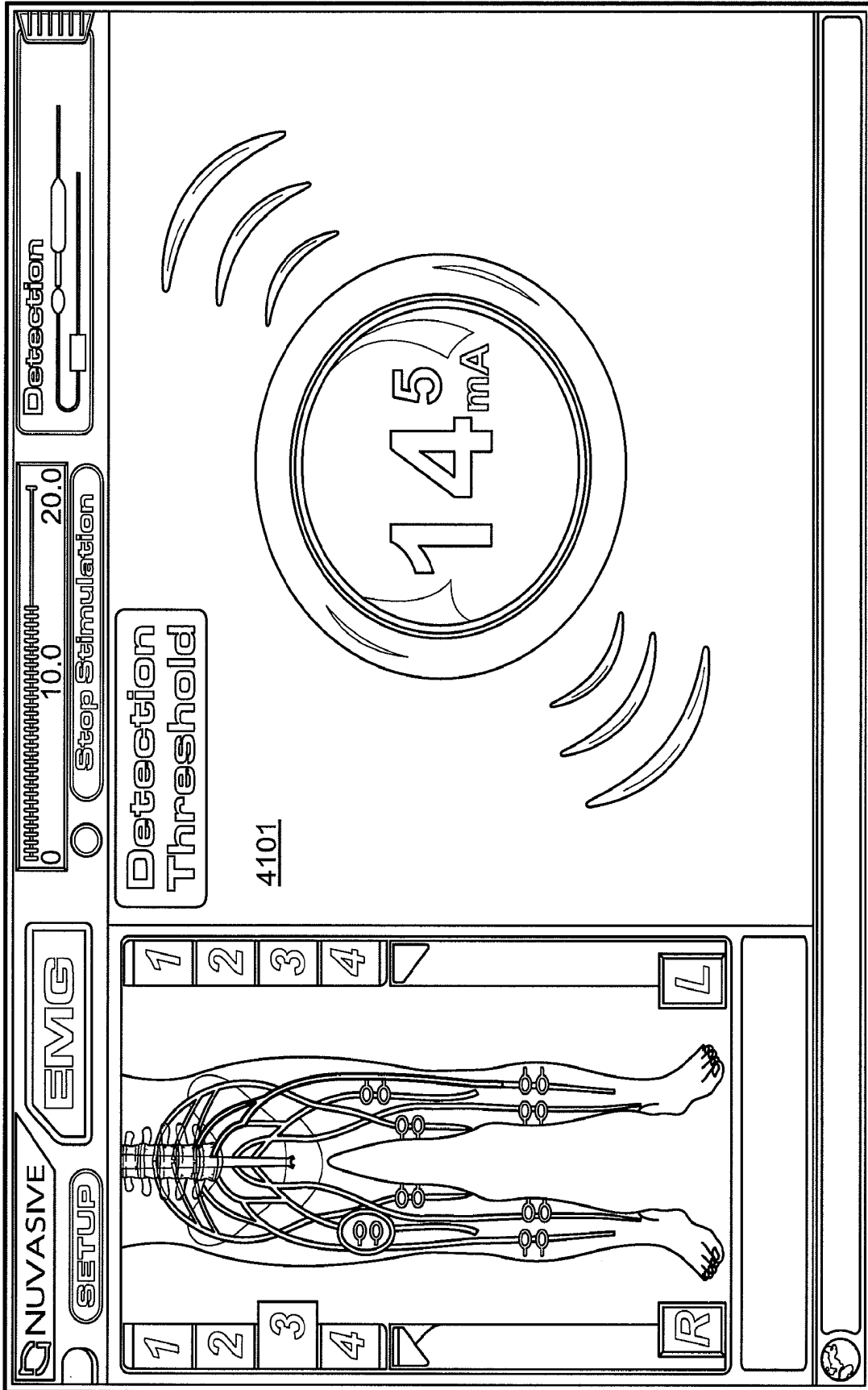

FIG. 41

Veal T-Bone Stripped of Muscle

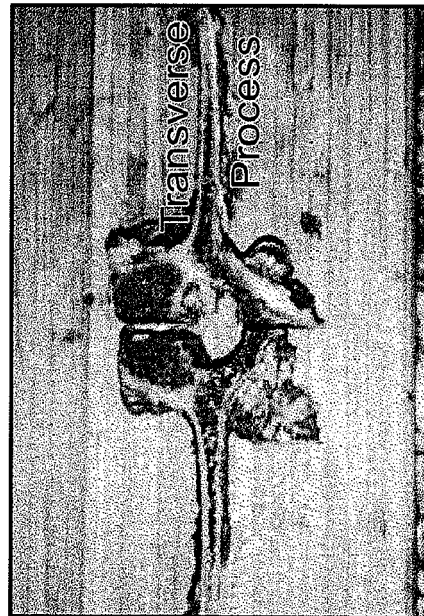
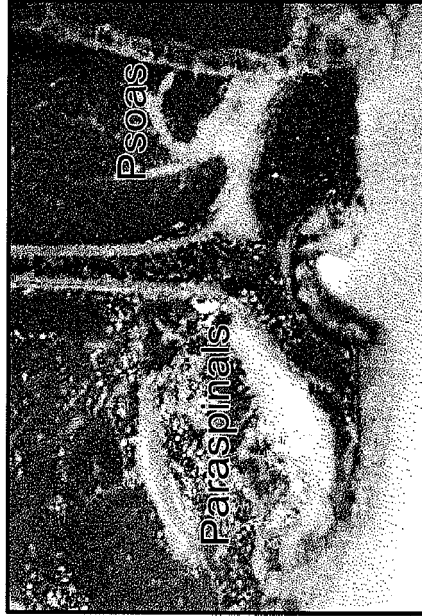

FIG. 42



FIG. 43

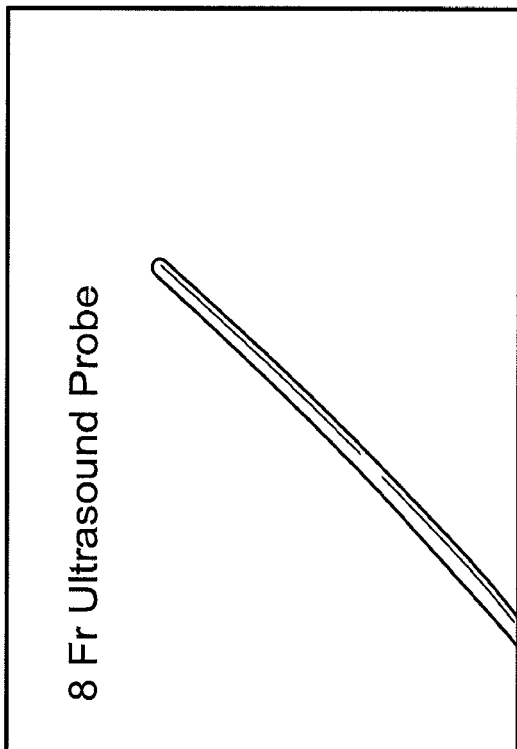
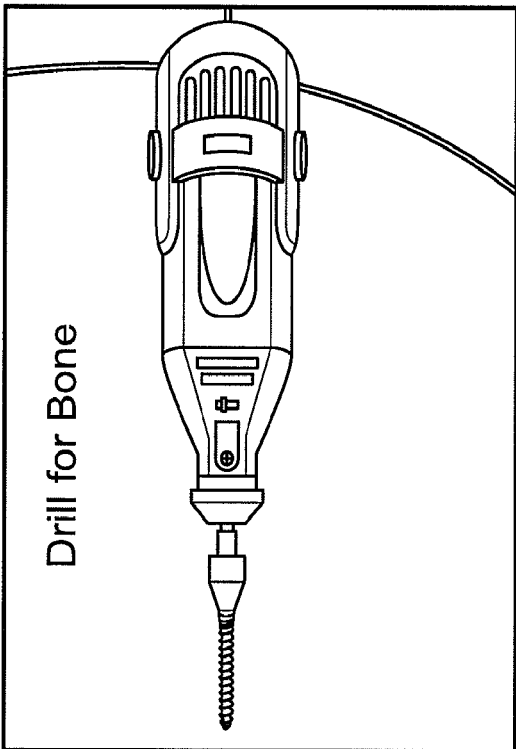
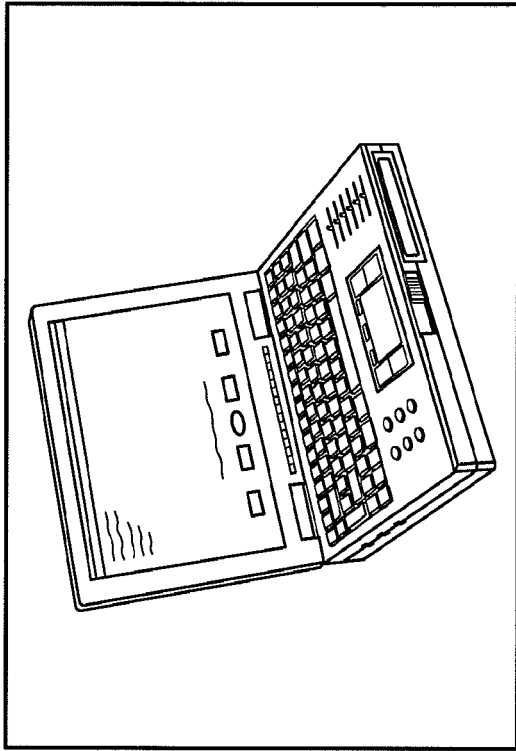

FIG. 44

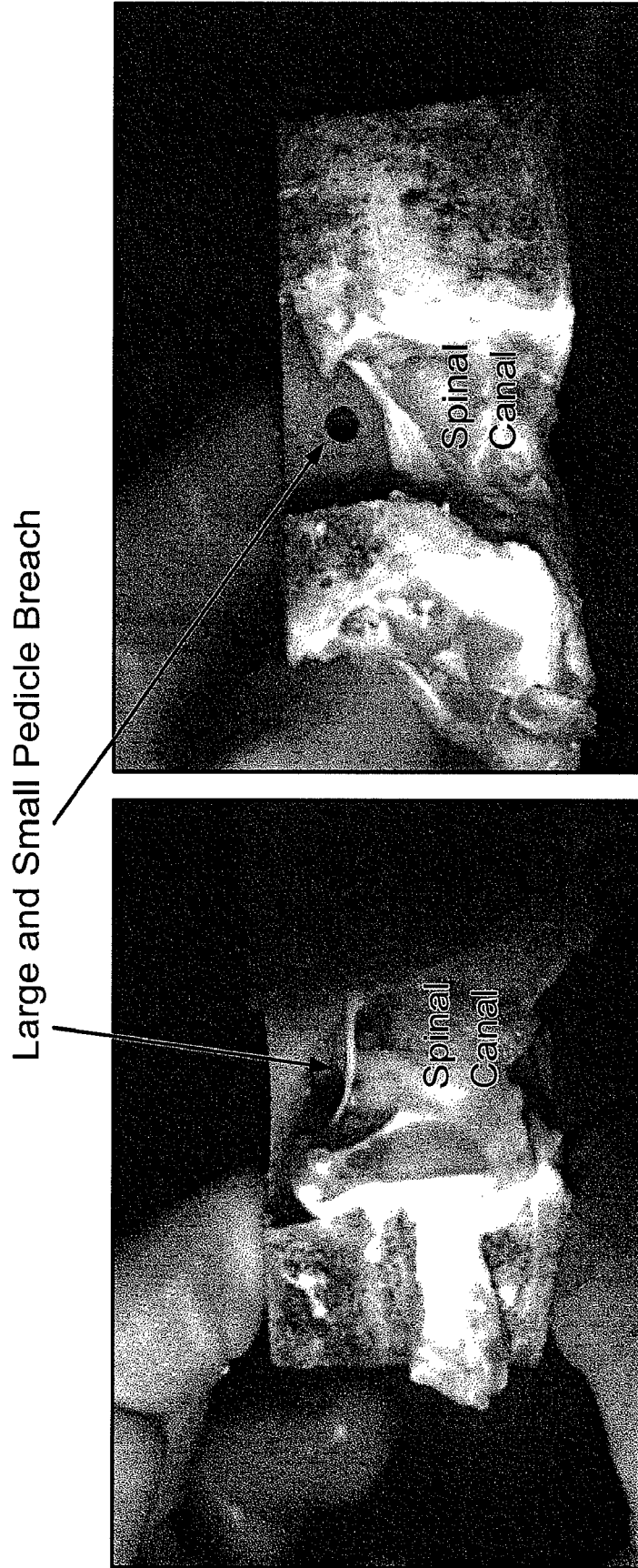

FIG. 45

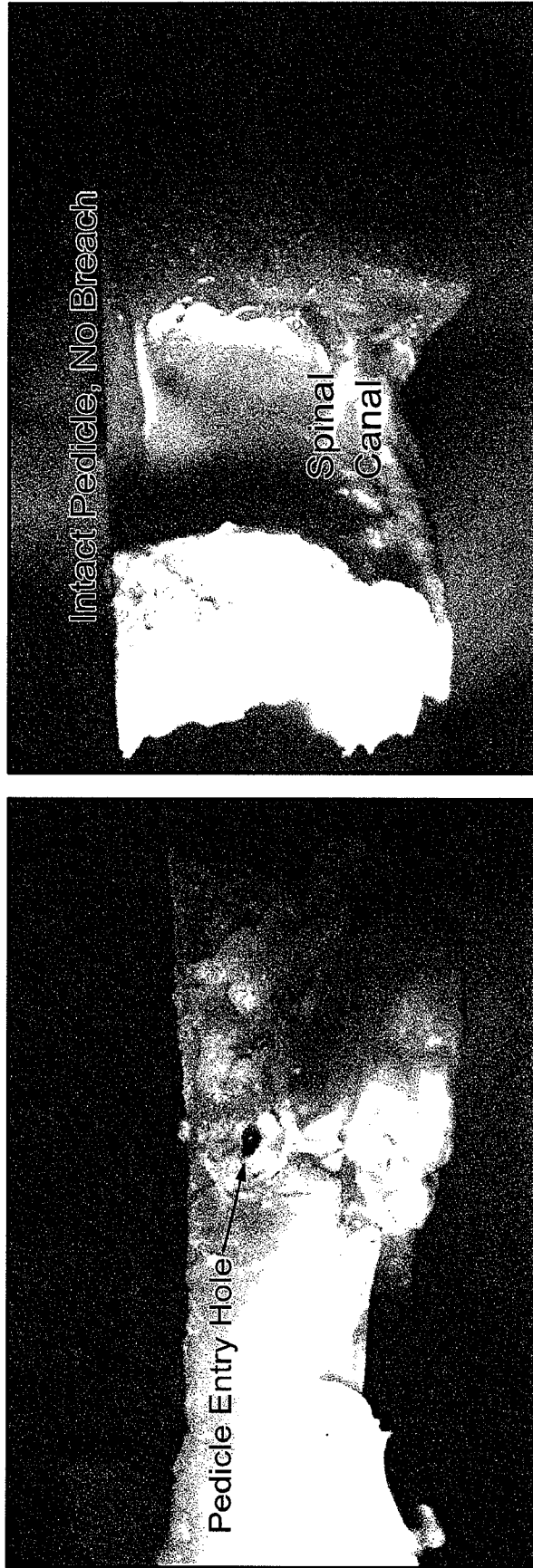

FIG. 46

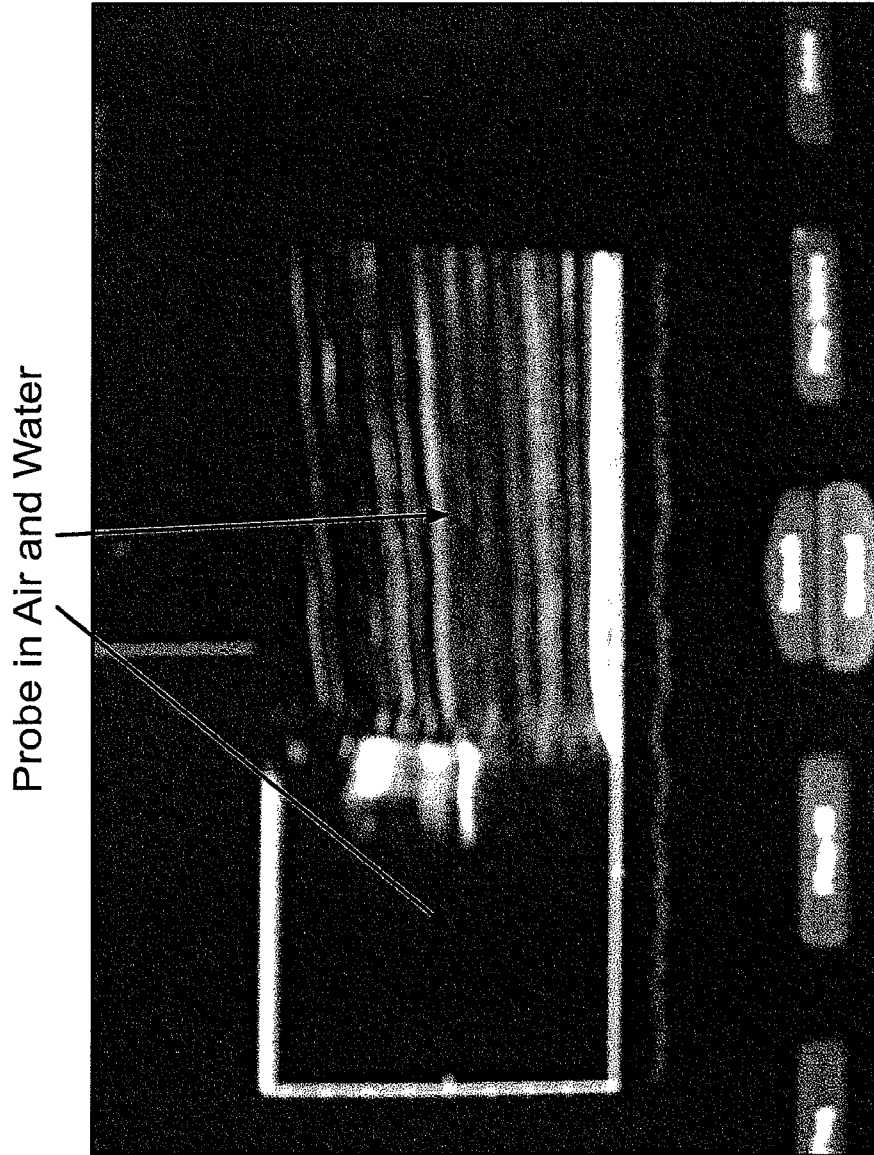
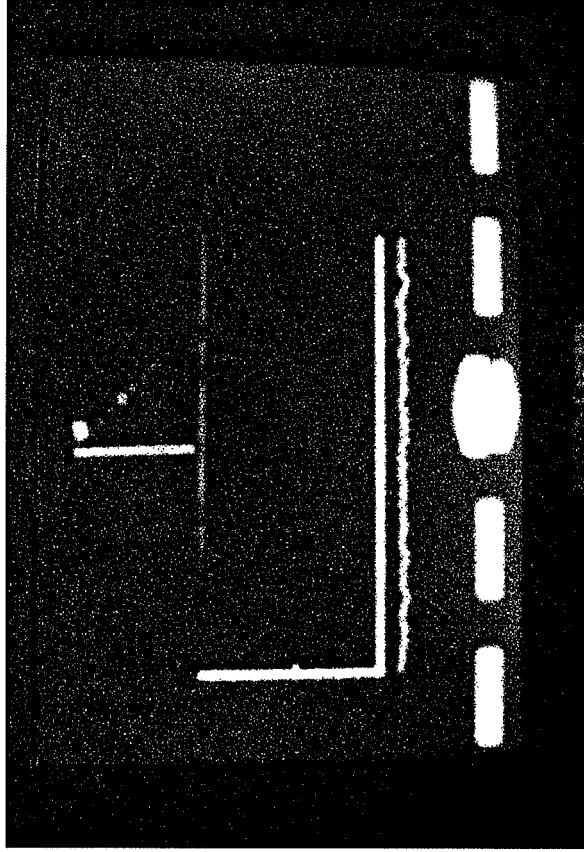

FIG. 47

No Signal Detected with Probe



Intact Pedicle, no Breach



FIG. 48

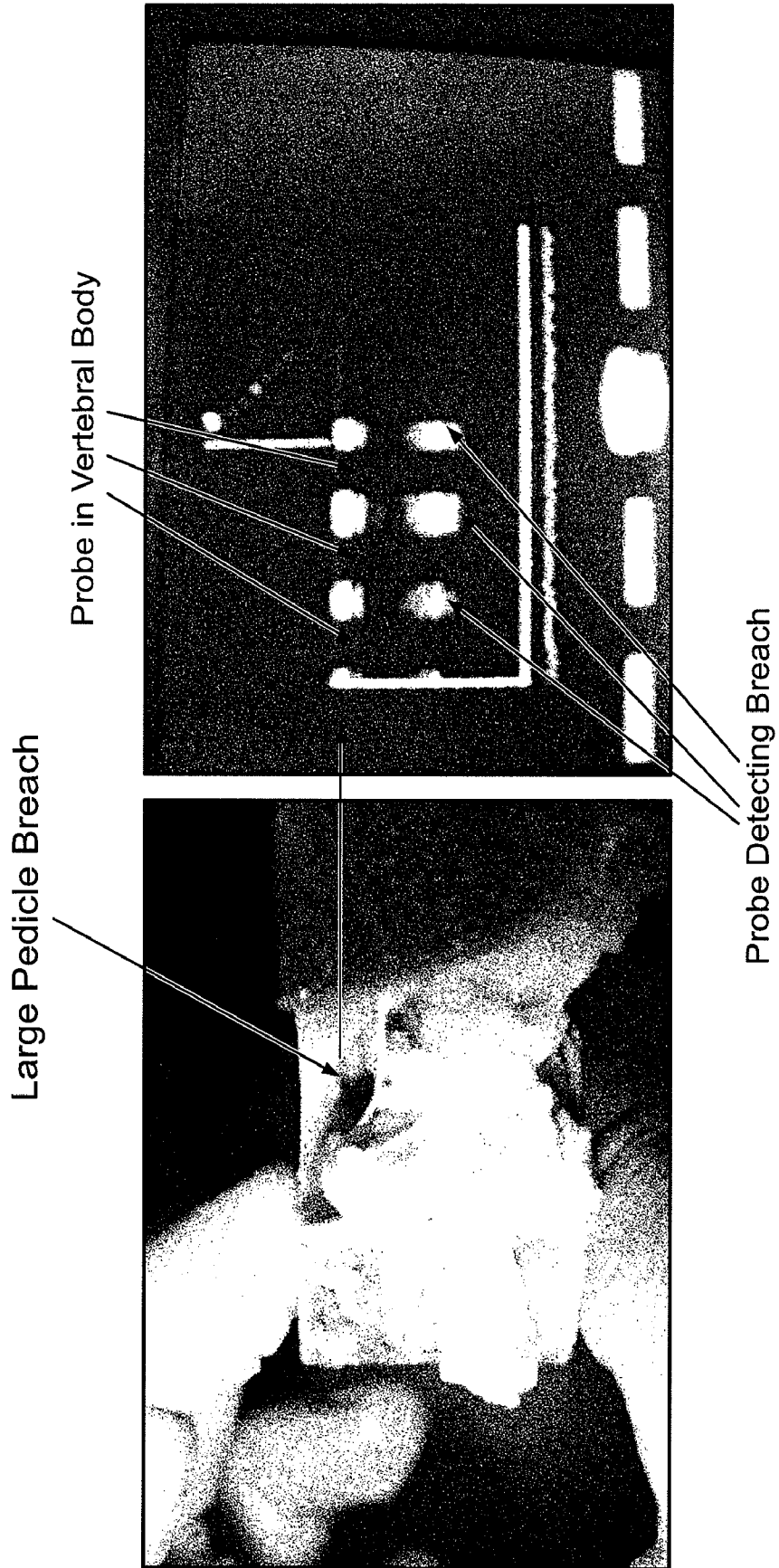

**FIG. 49**

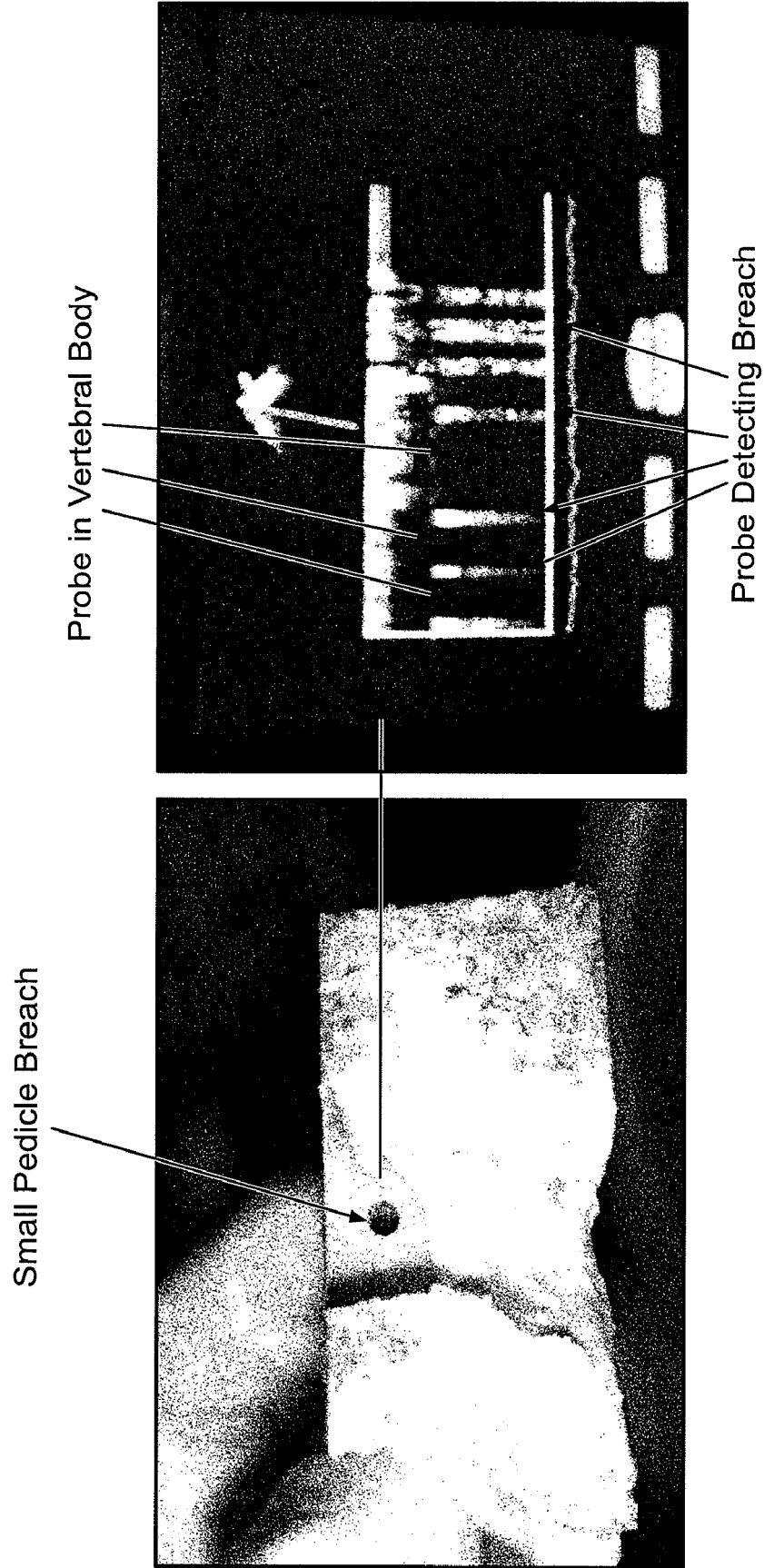

FIG. 50

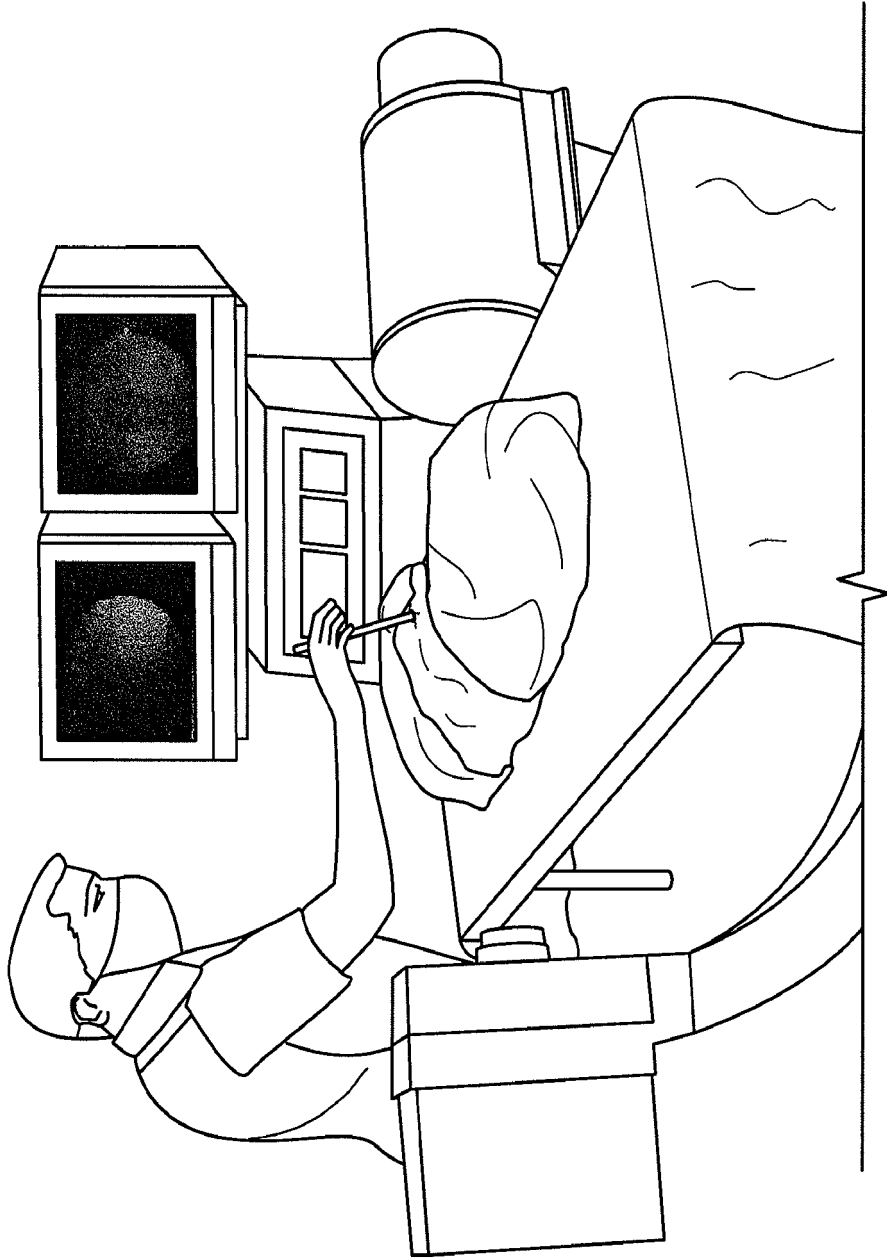
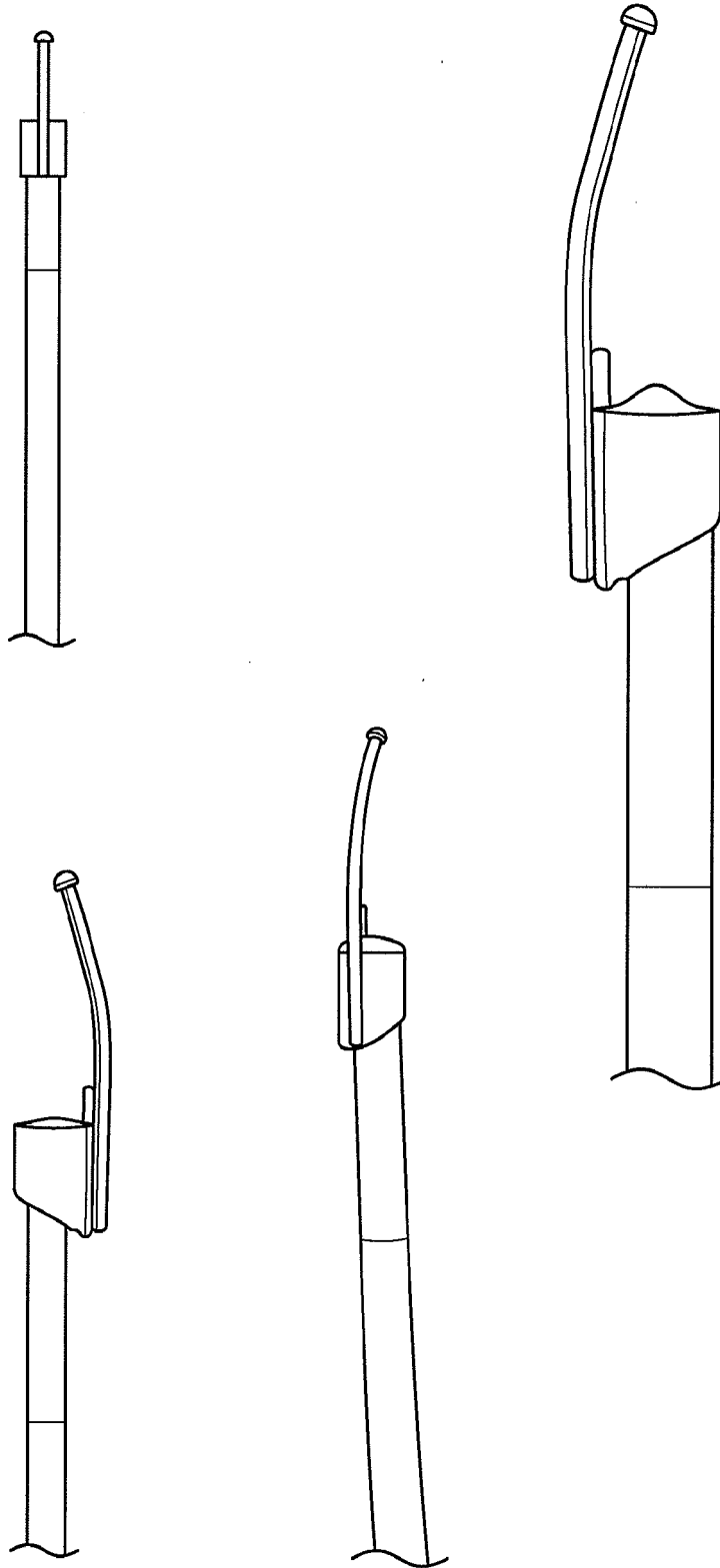

FIG. 51

**3.18 mm Aloka Side Firing Ultrasound Probe Fitted with Detachable  
Pedicle Feeler/Sounder**



**FIG. 52**

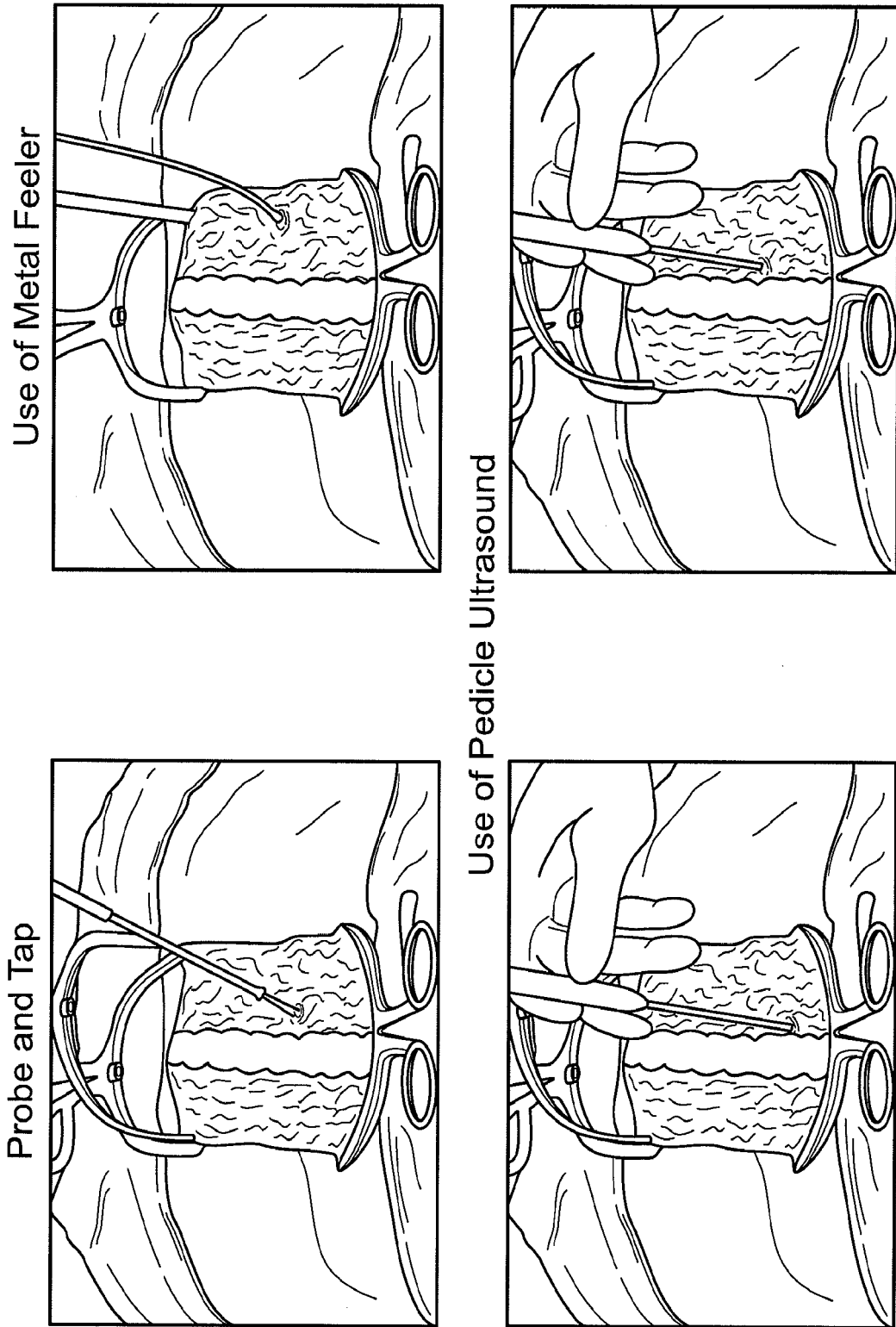

FIG. 53

Data Collected and Compared for Metal Pedicle Feeler (top) vs. Pedicle Ultrasound (Bottom)

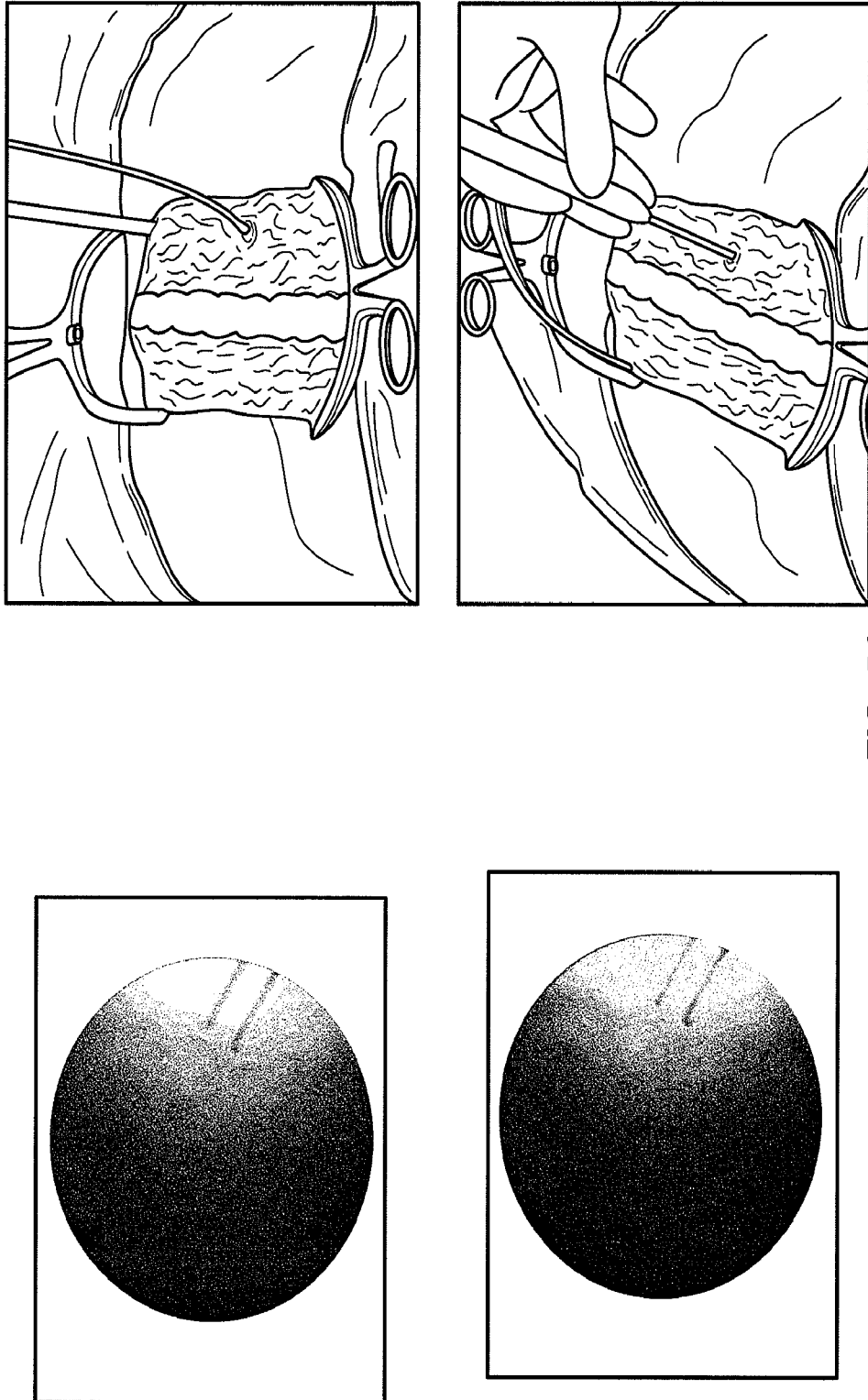
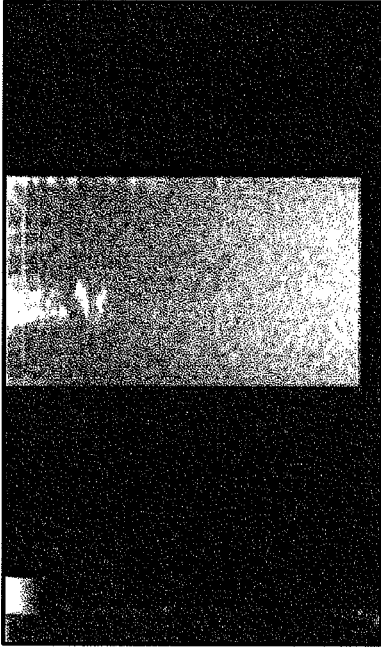
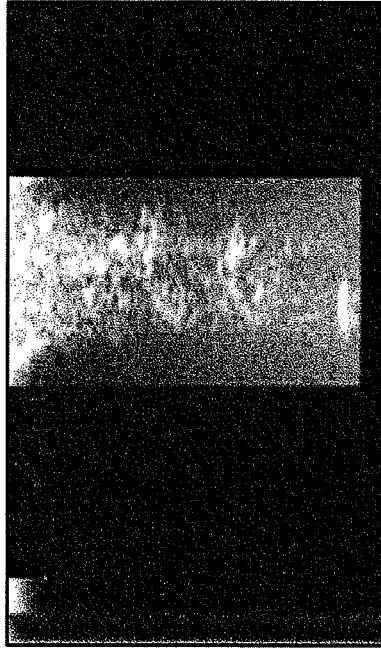

FIG. 54

2.5 mm Pedicle Breach



4.0 mm Pedicle Breach



Normal Pedicle, No Breach

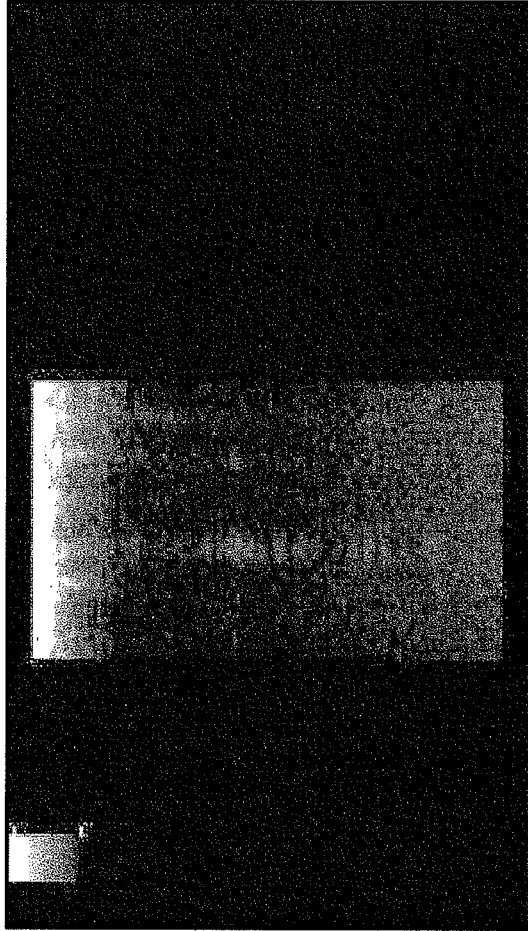

FIG. 55

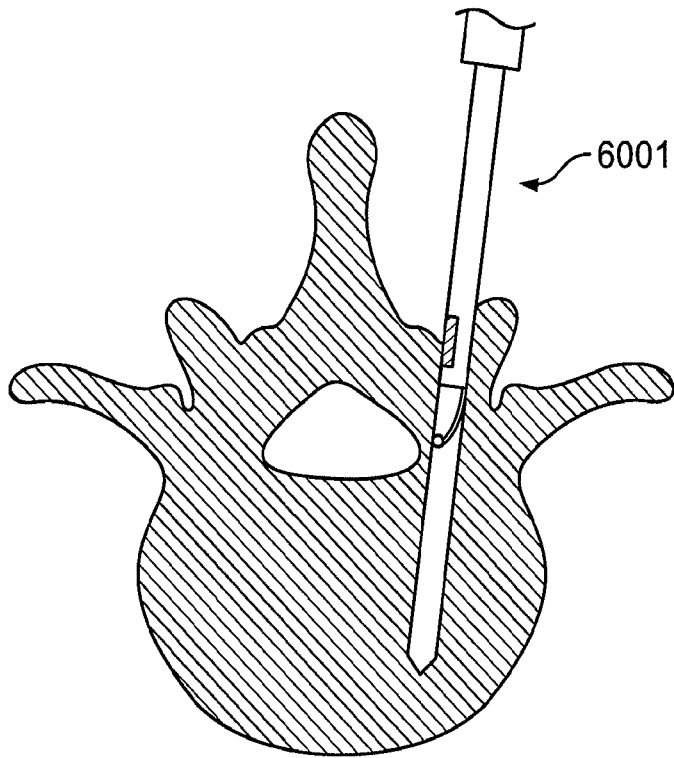

FIG. 56

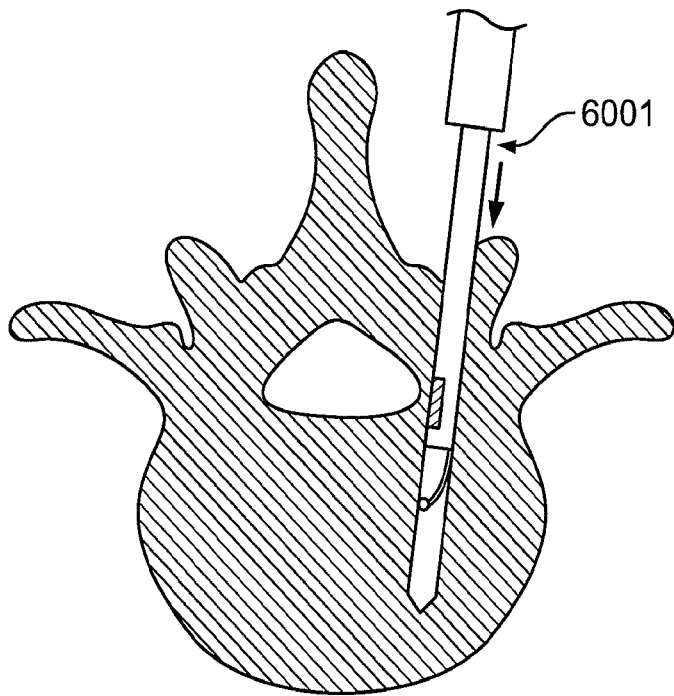

FIG. 57

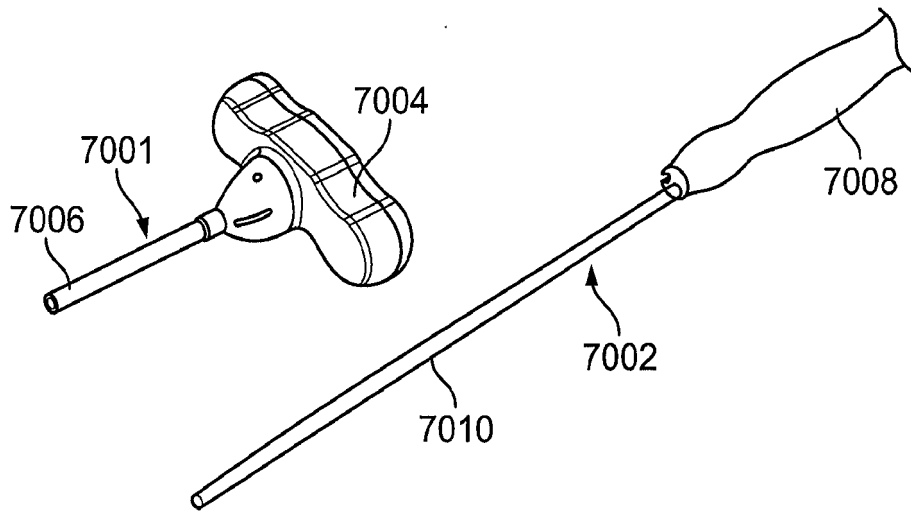

FIG. 58

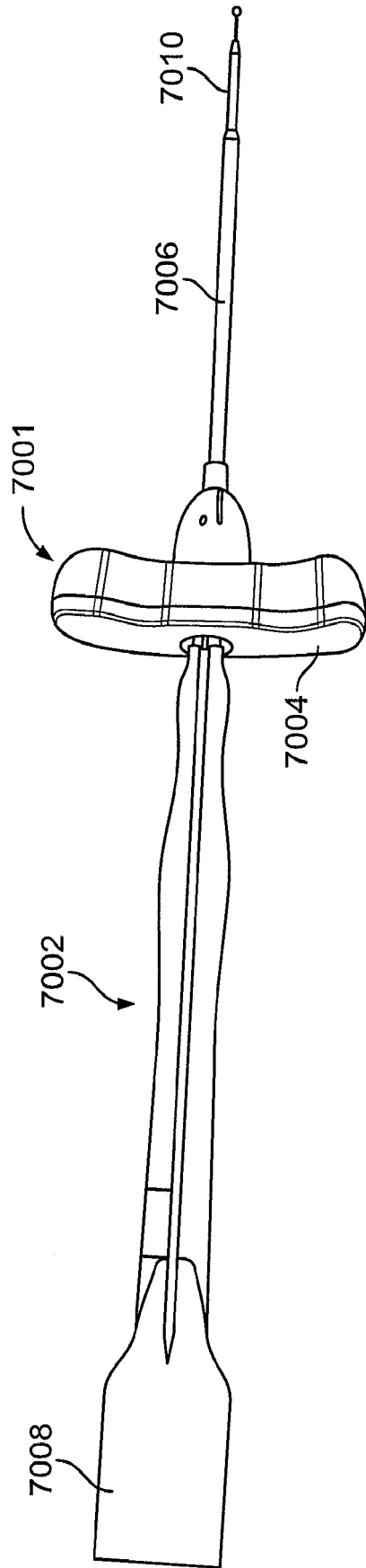

FIG. 59

**REFERENCES CITED IN THE DESCRIPTION**

*This list of references cited by the applicant is for the reader's convenience only. It does not form part of the European patent document. Even though great care has been taken in compiling the references, errors or omissions cannot be excluded and the EPO disclaims all liability in this regard.*

**Patent documents cited in the description**

- WO 61176373 A [0001]
- WO 2008089496 A2 [0007]

专利名称(译)	用于整形外科应用的超声系统和方法		
公开(公告)号	<a href="#">EP2427117A4</a>	公开(公告)日	2015-11-11
申请号	EP2010772828	申请日	2010-05-06
[标]申请(专利权)人(译)	日立阿洛卡医疗株式会社 FREL BRUCE中号		
申请(专利权)人(译)	日立ALOKA MEDICAL. , LTD. 弗兰克尔BRUCE M.		
当前申请(专利权)人(译)	日立ALOKA MEDICAL. , LTD. 弗兰克尔BRUCE M.		
[标]发明人	FRANKEL BRUCE M BARASO RANDALL R TSUCHIDA KAZUTOSHI WAKABAYASHI HIROAKI		
发明人	FRANKEL, BRUCE, M. BARASO, RANDALL, R. TSUCHIDA, KAZUTOSHI WAKABAYASHI, HIROAKI		
IPC分类号	A61B8/12		
优先权	61/176373 2009-05-07 US		
其他公开文献	EP2427117B1 EP2427117A1		
外部链接	<a href="#">Espacenet</a>		

#### 摘要(译)

提供了医疗诊断仪器和系统，其包括 ( i ) 近端手柄，其构造和尺寸设计成允许操作者手动抓握器械; ( ii ) 超声探头，其包括从手柄向远侧延伸并终止于远端的纵向轴，以及相对于纵向轴安装在其远端附近的超声换能器，超声换能器包括超声能量产生元件阵列; ( iii ) 相对于超声探头安装的触觉探针，该触觉探针包括相对于超声探头的纵轴安装并向远端延伸超过其远端的纵轴，以及探针尖端 ( 例如，球形尖端 ) 限定在触觉探针的纵向轴的远端。还提供了使用所公开的器械和系统的有利方法，例如，用于检测与椎弓根螺钉放置相关的皮质骨中的缺口。