



US009314166B1

(12) **United States Patent**  
**Brady et al.**

(10) **Patent No.:** **US 9,314,166 B1**  
(45) **Date of Patent:** **\*Apr. 19, 2016**

- (54) **MONITORING DEVICE WITH A PEDOMETER**
- (71) Applicant: **Impact Sports Technologies, Inc.**, San Diego, CA (US)
- (72) Inventors: **Donald Brady**, Las Vegas, NV (US); **Nikolai Rulkov**, San Diego, CA (US); **Mark Hunt**, San Diego, CA (US)
- (73) Assignee: **Impact Sports Technologies, Inc.**, Las Vegas, NV (US)
- (\* ) Notice: Subject to any disclaimer, the term of this patent is extended or adjusted under 35 U.S.C. 154(b) by 347 days.  
  
This patent is subject to a terminal disclaimer.

*5/02416* (2013.01); *A61B 5/11* (2013.01);  
*A61B 5/1118* (2013.01); *A61B 5/6804*  
(2013.01); *A61B 5/721* (2013.01); *A61B 5/742*  
(2013.01); *A61B 5/02427* (2013.01)

- (58) **Field of Classification Search**  
CPC .. A61B 5/02416; A61B 5/1118; A61B 5/721;  
A61B 5/002; A61B 5/7445; A61B 5/1112;  
A61B 5/0205; A61B 5/0082; A61B 5/11;  
A61B 5/6804; A61B 5/742; A61B 5/02427;  
G01C 22/006  
USPC ..... 600/301, 485, 500, 503, 502, 324;  
702/160, 182  
See application file for complete search history.

- (21) Appl. No.: **14/145,833**
- (22) Filed: **Dec. 31, 2013**

**Related U.S. Application Data**

- (63) Continuation of application No. 13/913,416, filed on Jun. 8, 2013, now Pat. No. 8,663,118, which is a continuation of application No. 13/712,992, filed on Dec. 13, 2012, now Pat. No. 8,460,197, which is a continuation of application No. 13/494,084, filed on Jun. 12, 2012, now Pat. No. 9,109,902.
- (60) Provisional application No. 61/496,046, filed on Jun. 13, 2011.

- (51) **Int. Cl.**  
*A61B 5/0205* (2006.01)  
*A61B 5/024* (2006.01)  
*A61B 5/00* (2006.01)  
*A61B 5/11* (2006.01)

- (52) **U.S. Cl.**  
CPC ..... *A61B 5/0205* (2013.01); *A61B 5/002*  
(2013.01); *A61B 5/0082* (2013.01); *A61B*

(56) **References Cited**

U.S. PATENT DOCUMENTS

5,830,137	A	11/1998	Scharf	
7,865,224	B2	1/2011	Baker, Jr. et al.	
7,983,876	B2	7/2011	Vock et al.	
9,079,060	B2 *	7/2015	Hong	G01P 9/02
9,143,569	B2 *	9/2015	Mensingher	A61B 5/7445
9,149,223	B2 *	10/2015	Spears	A61B 5/1112
2009/0306736	A1	12/2009	Dobak, III	

\* cited by examiner

*Primary Examiner* — Ali Neyzari

(74) *Attorney, Agent, or Firm* — Clause Eight IPS; Michael Catania

(57) **ABSTRACT**

A monitoring device with a pedometer is disclosed herein. The monitoring device preferably comprises an article, an optical sensor, an accelerometer and processor. The optical sensor preferably comprises a photodetector and a plurality of light emitting diodes. A sensor signal from the optical sensor is processed with a filtered accelerometer output signal from the accelerometer to generate a pedometer function.

**14 Claims, 19 Drawing Sheets**

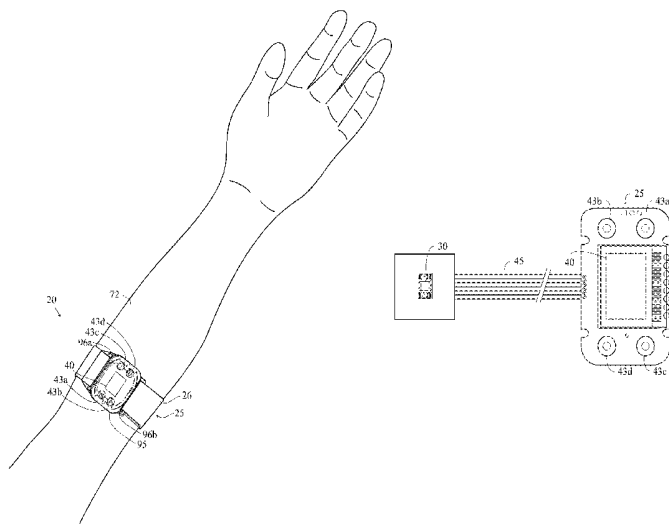

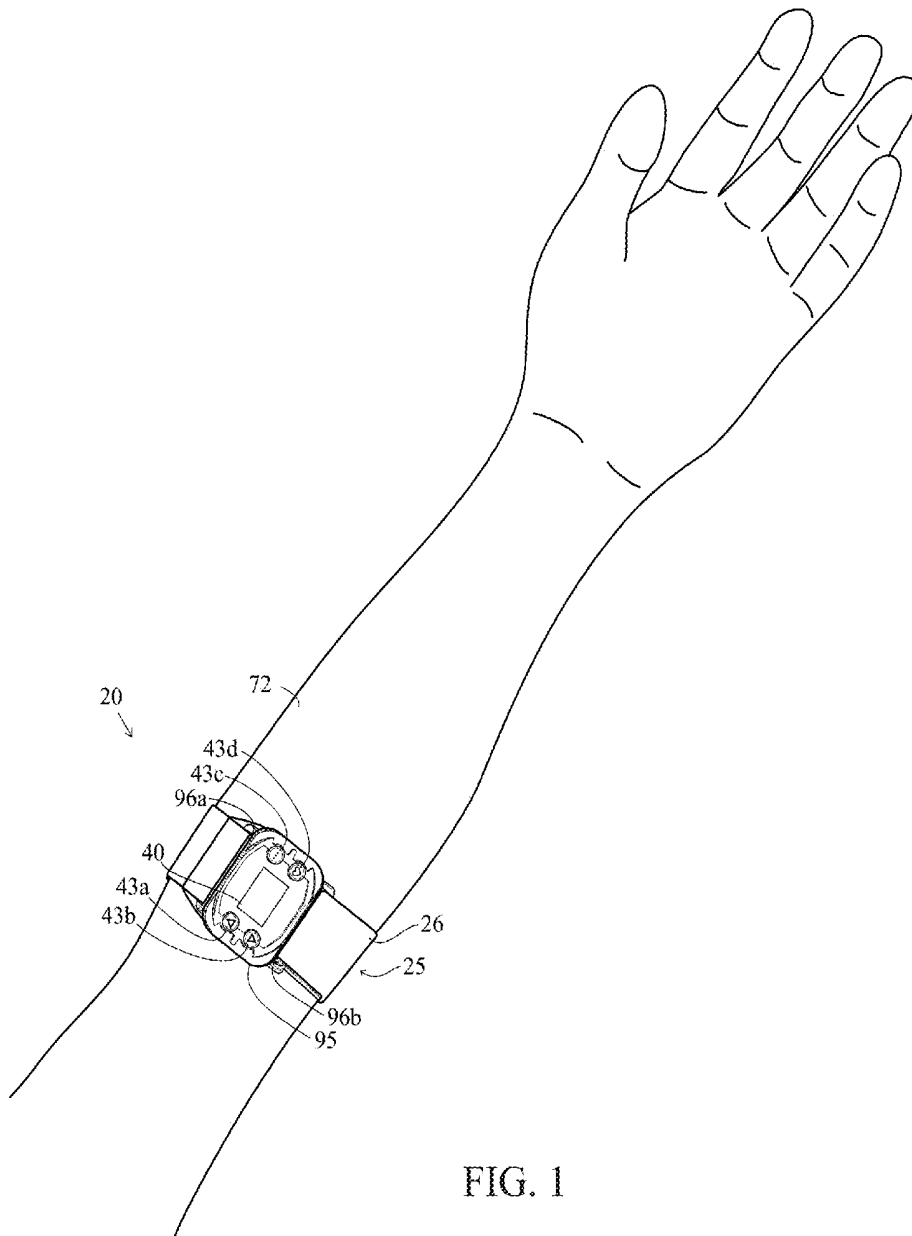

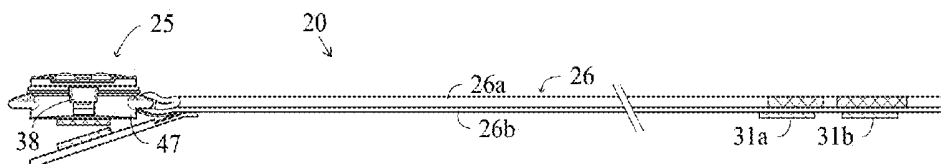

FIG. 2

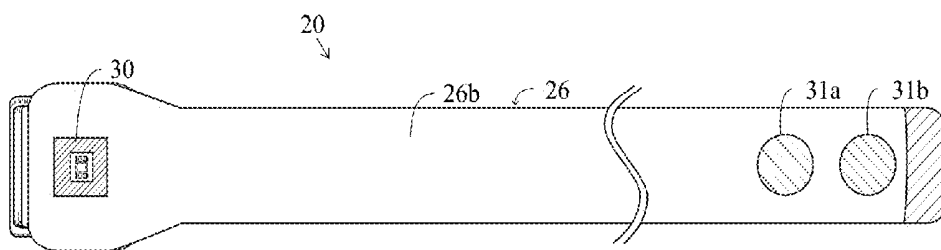

FIG. 3

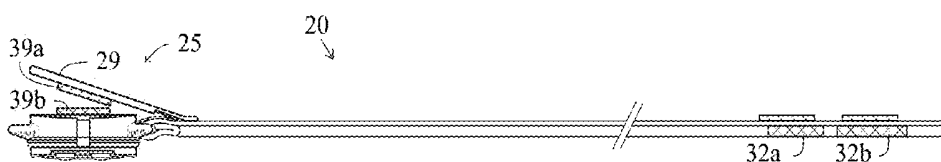

FIG. 4

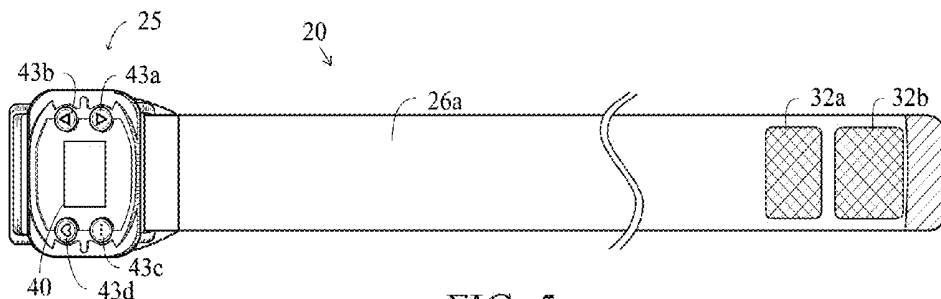

FIG. 5

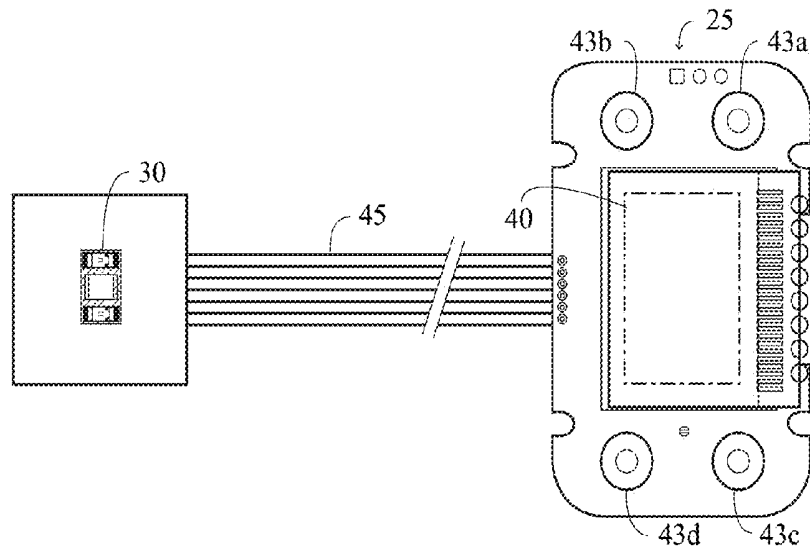

FIG. 6

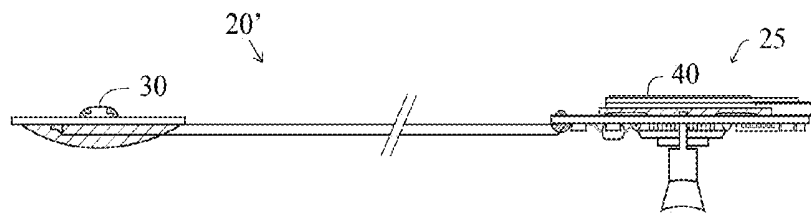

FIG. 7

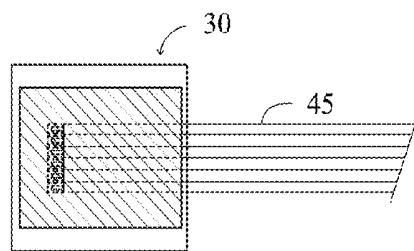

FIG. 8

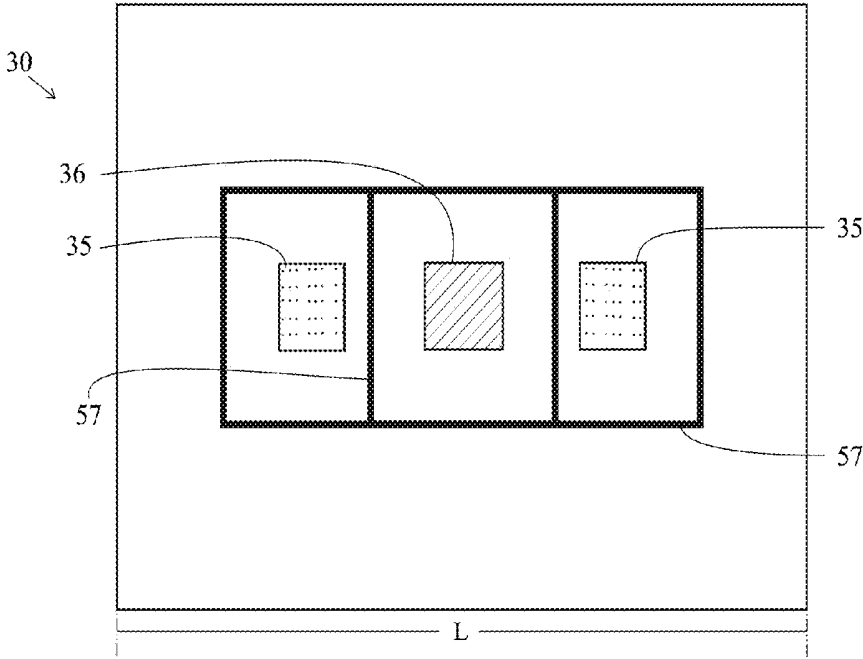

FIG. 9

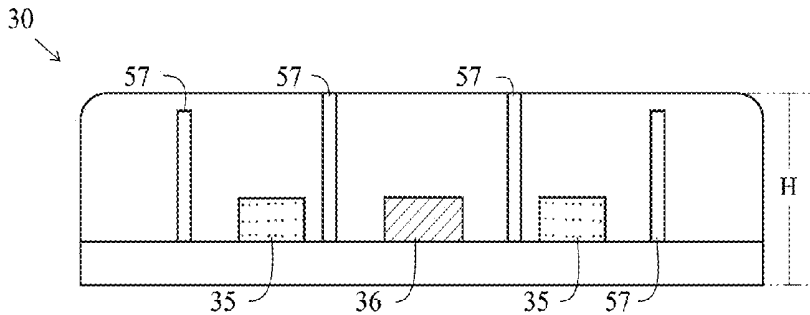

FIG. 10

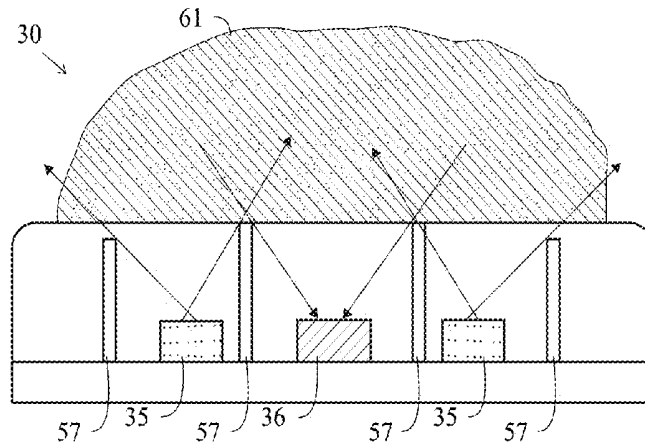

FIG. 11

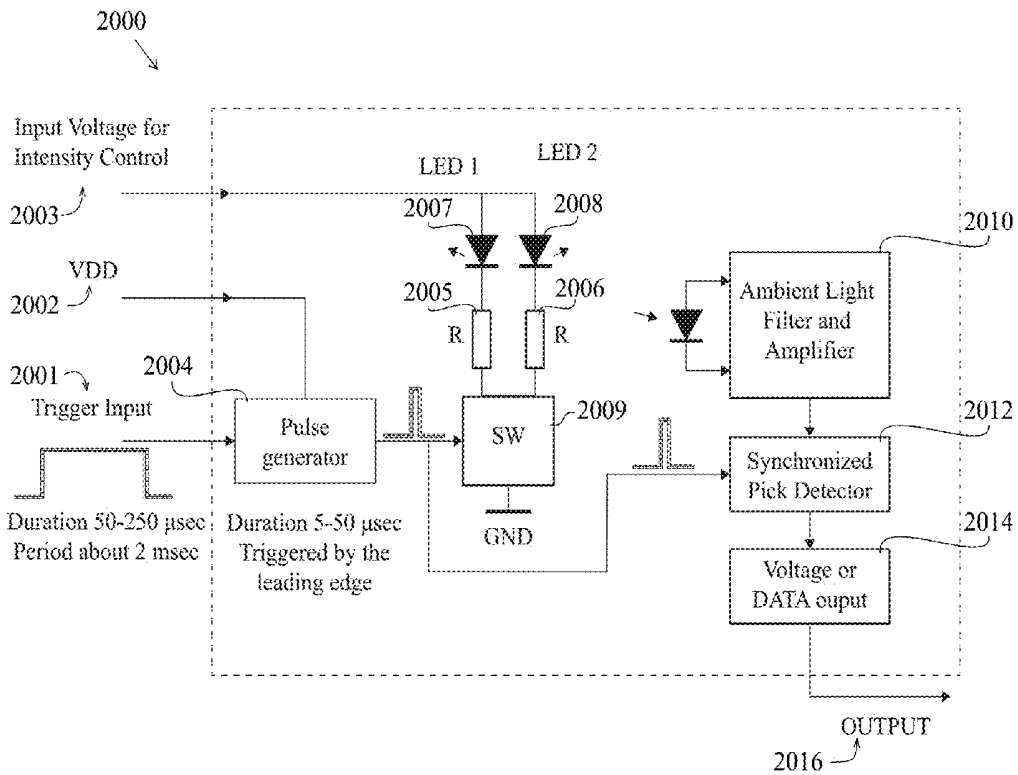

FIG. 12

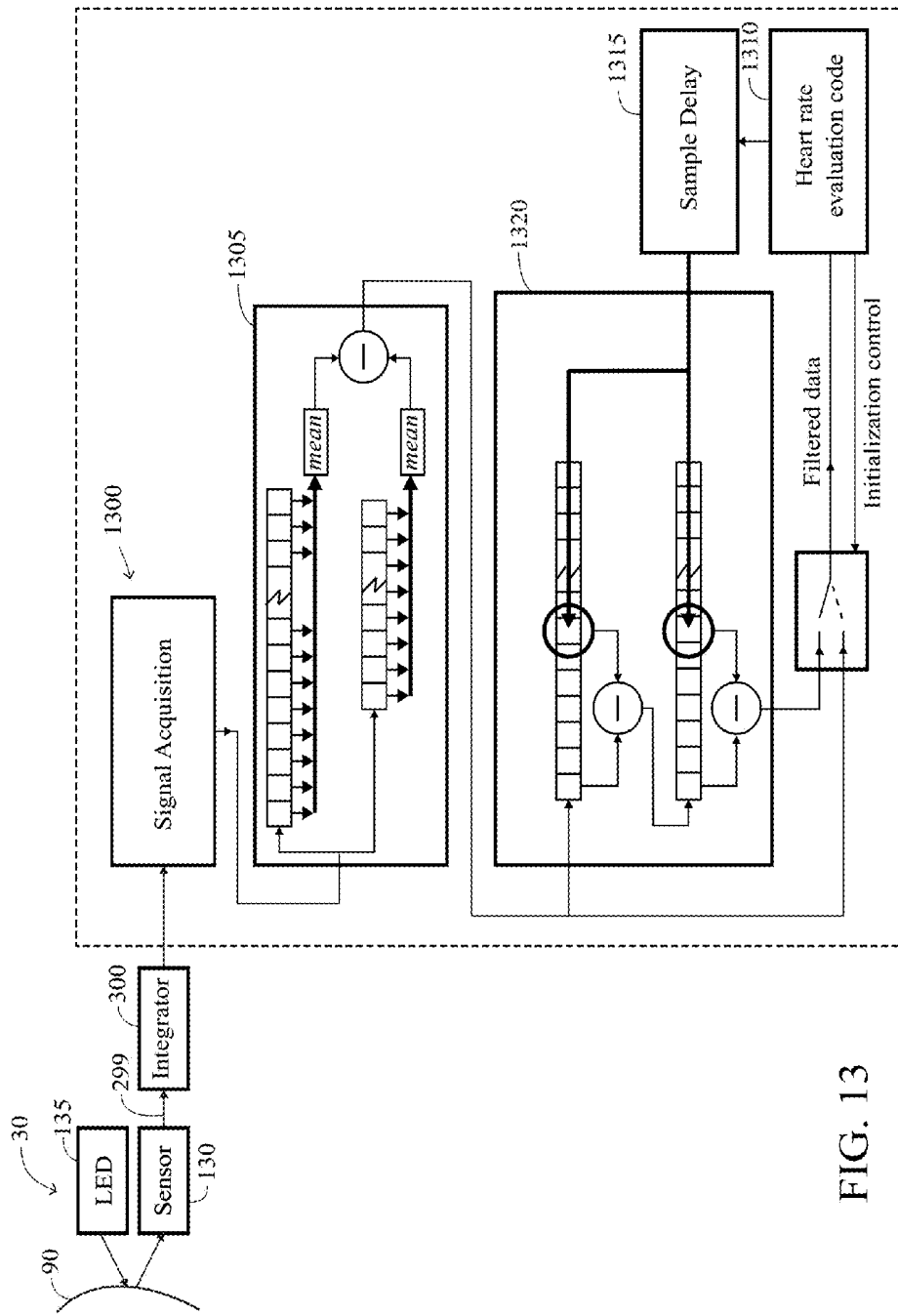

FIG. 13

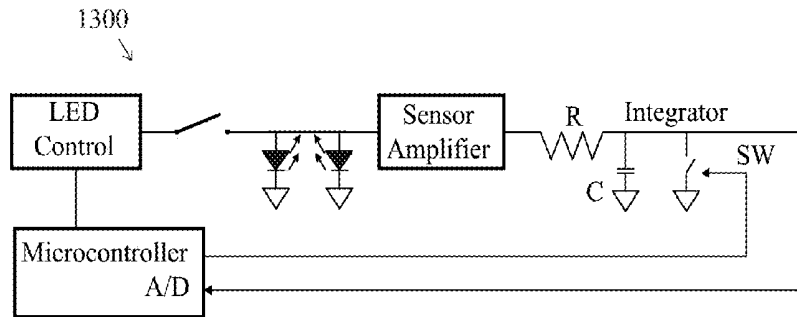

FIG. 14

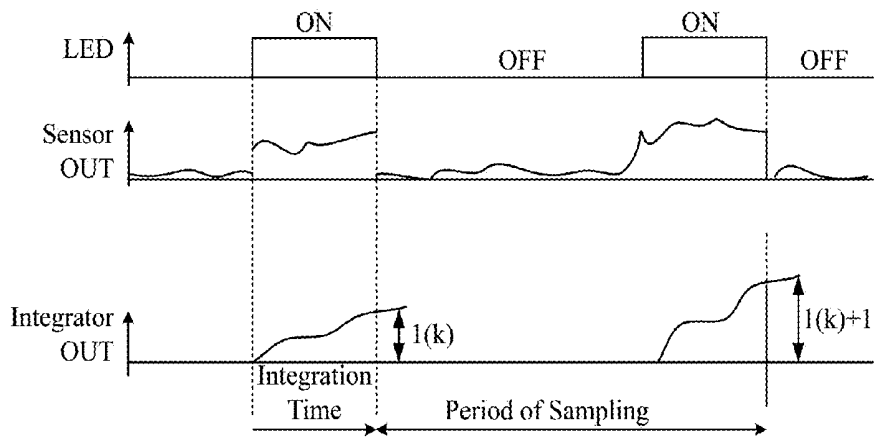

FIG. 15

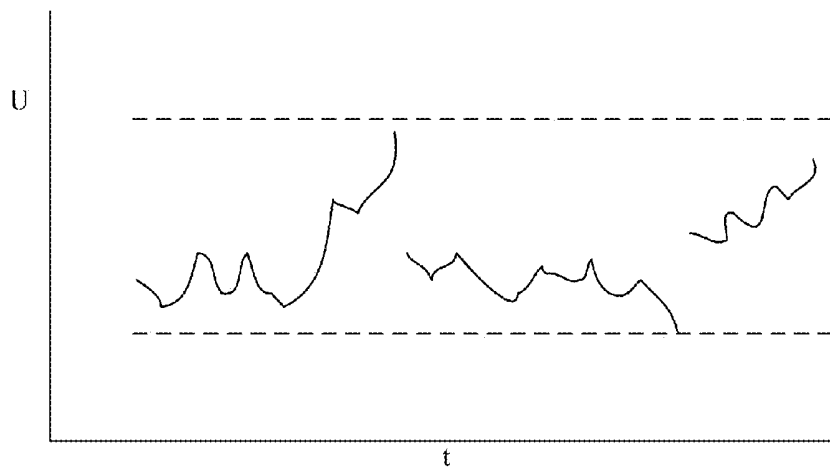

FIG. 16



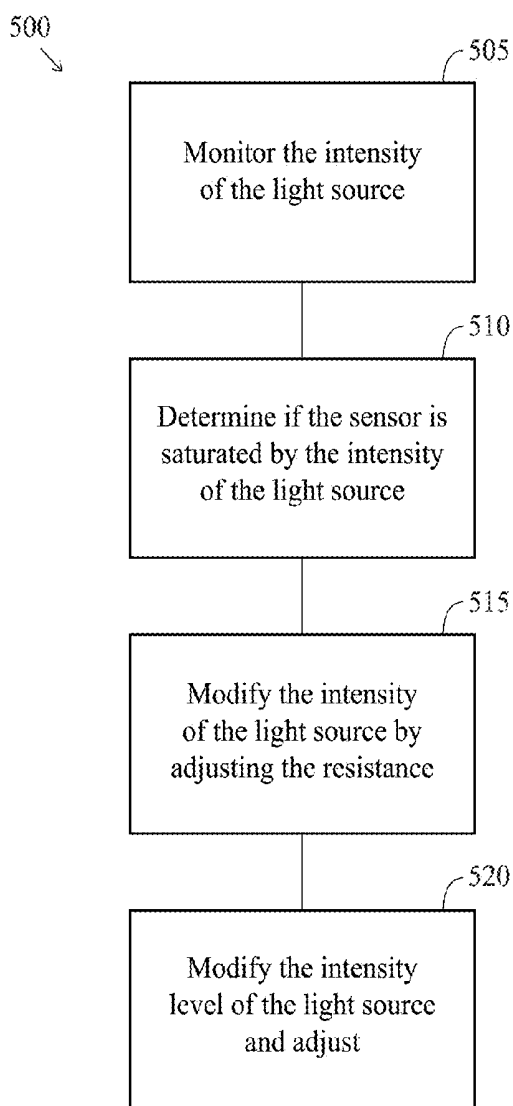

FIG. 17

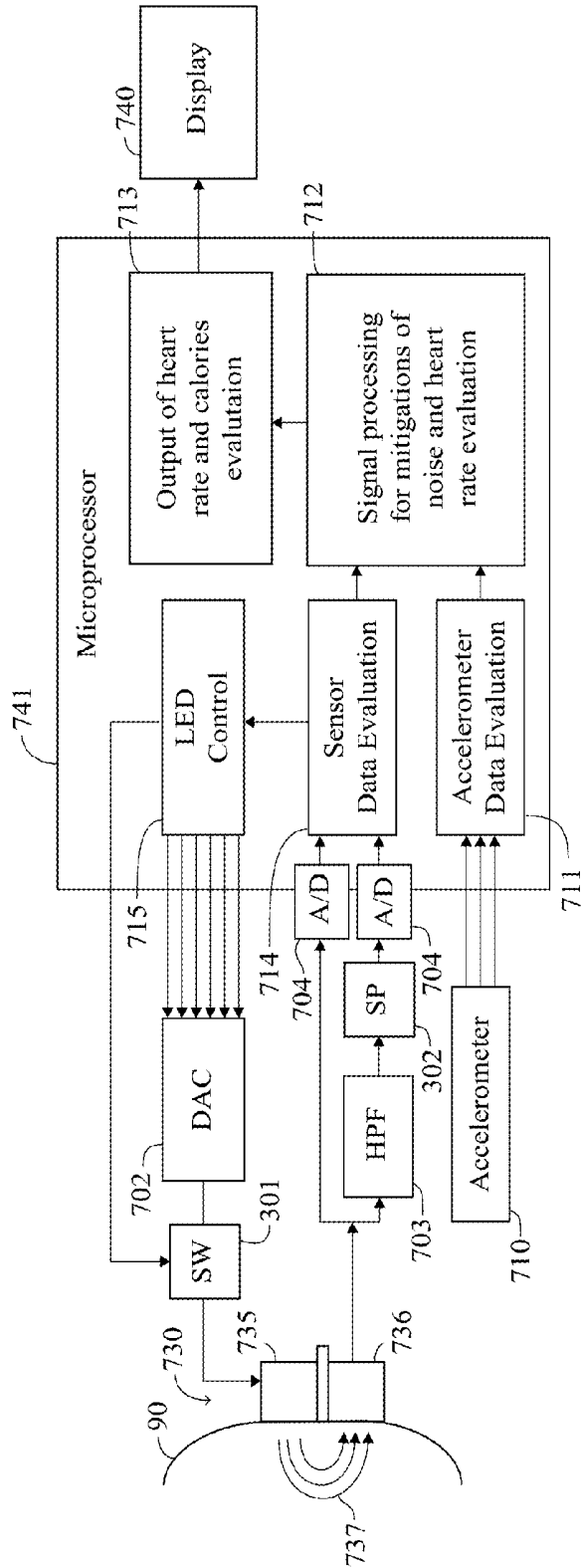

FIG. 18

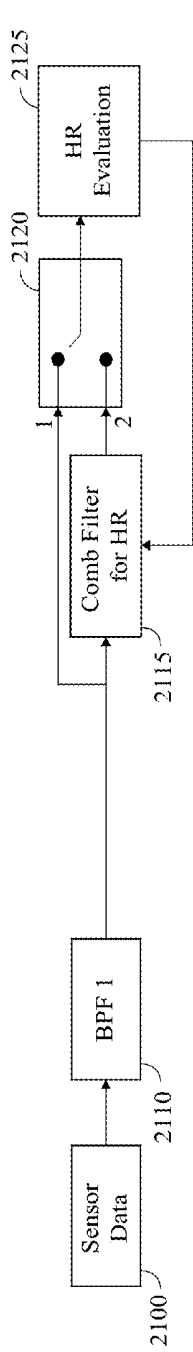

FIG. 19  
(PRIOR ART)

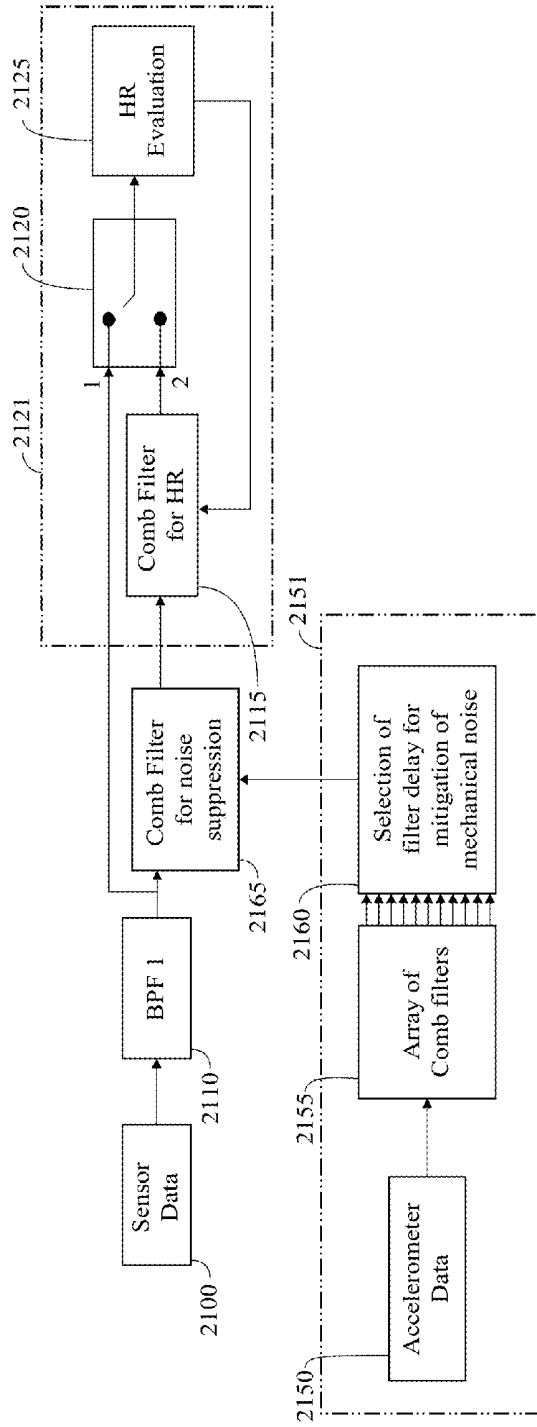

FIG. 20

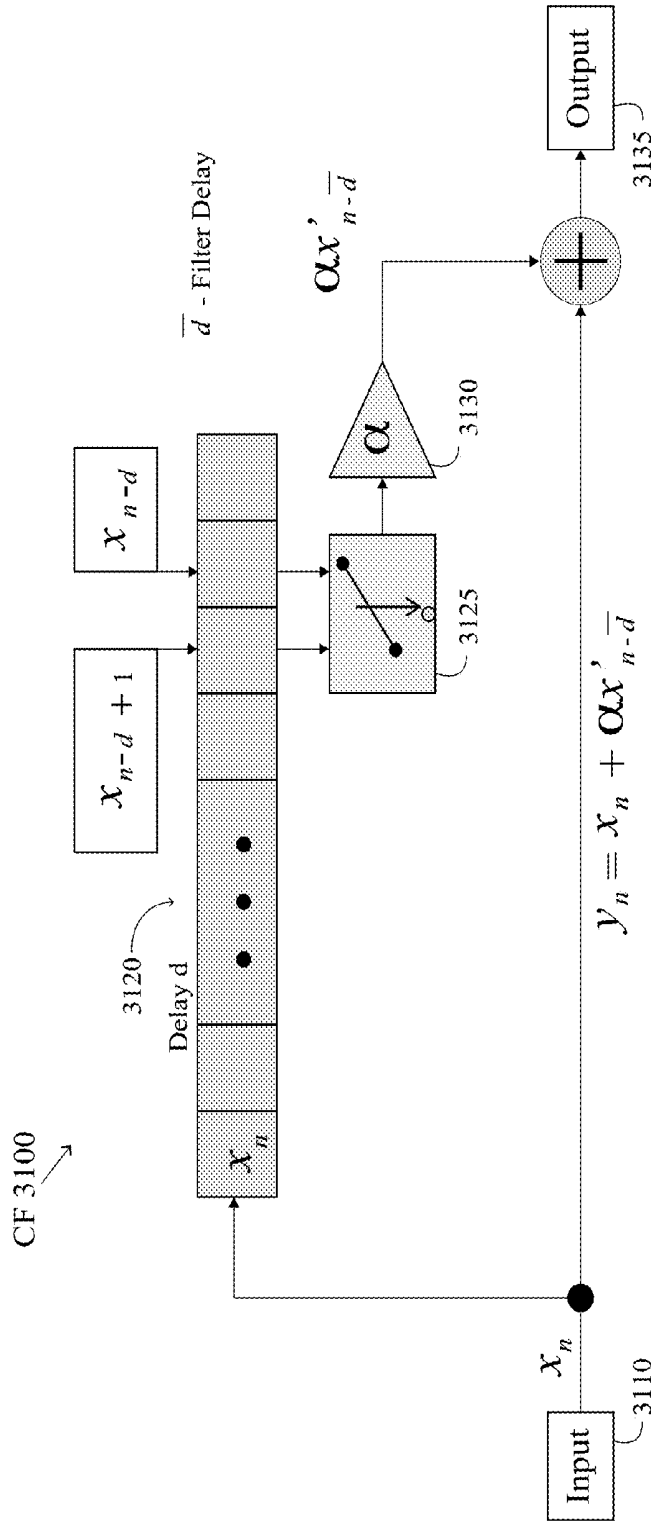

FIG. 21

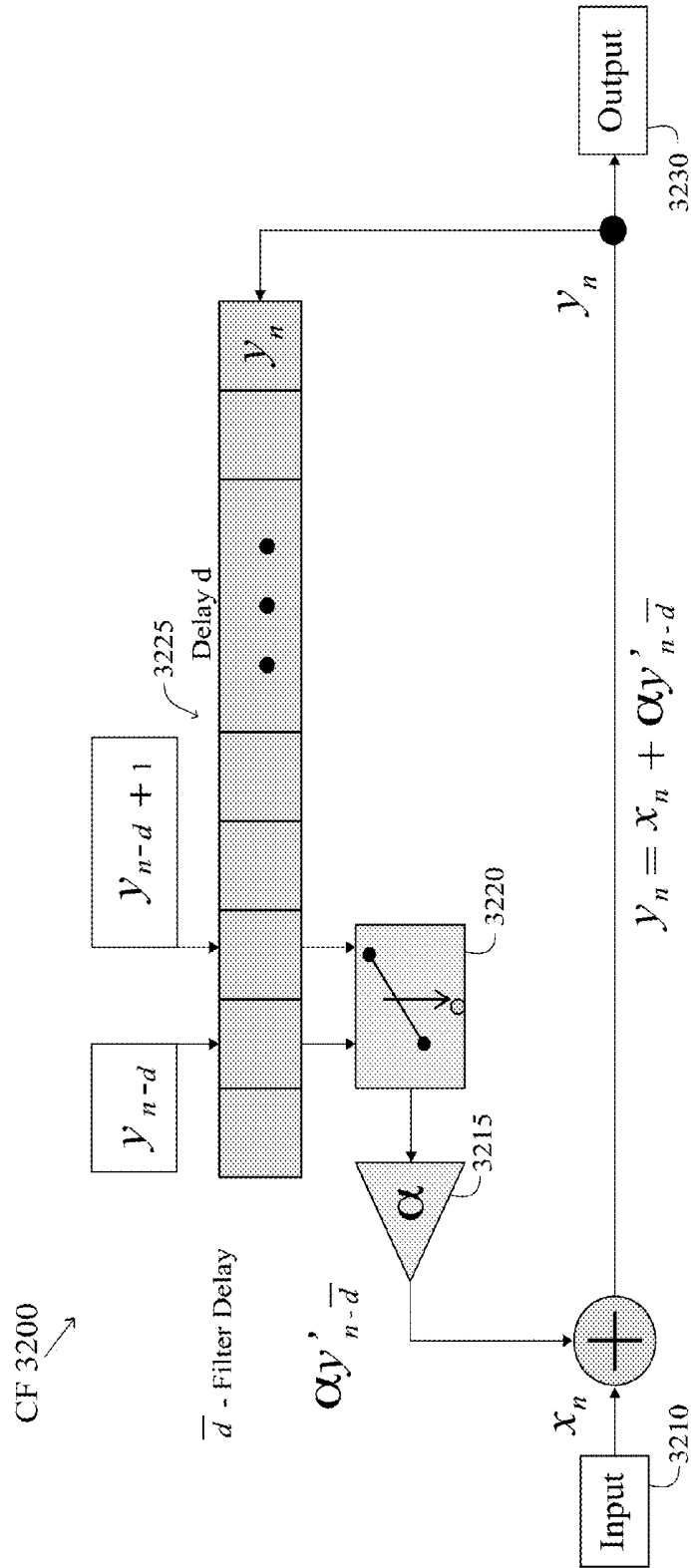

FIG. 22

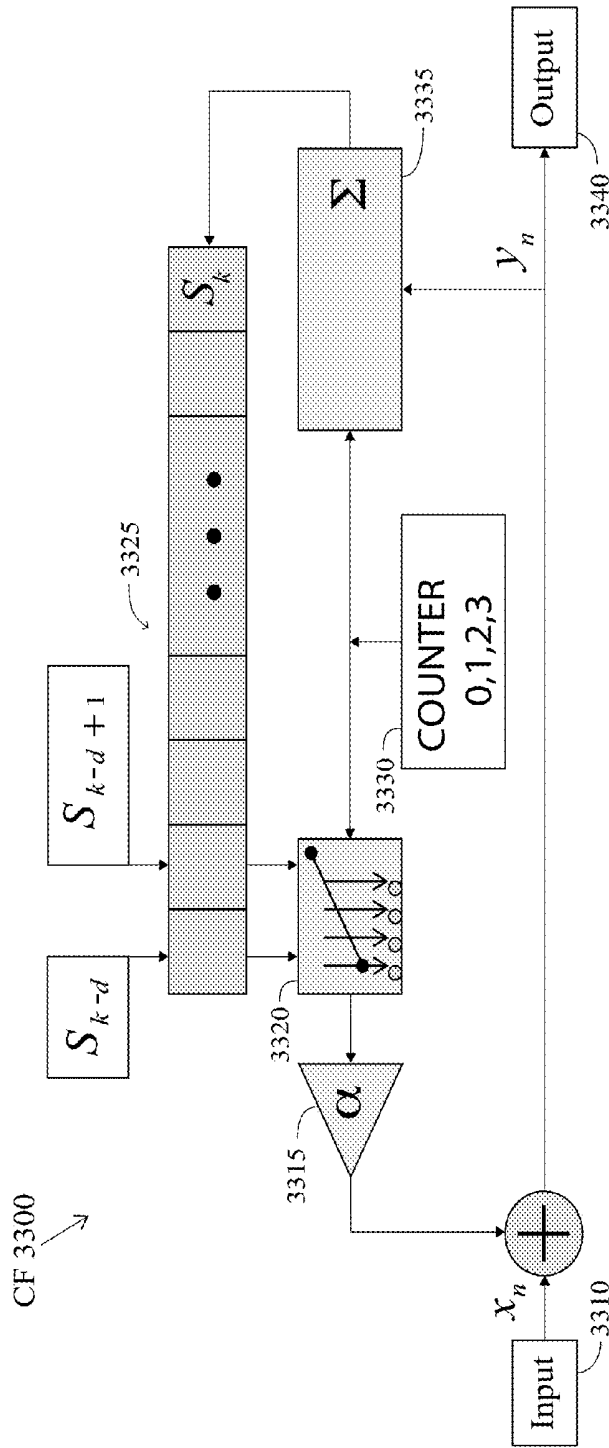

FIG. 23

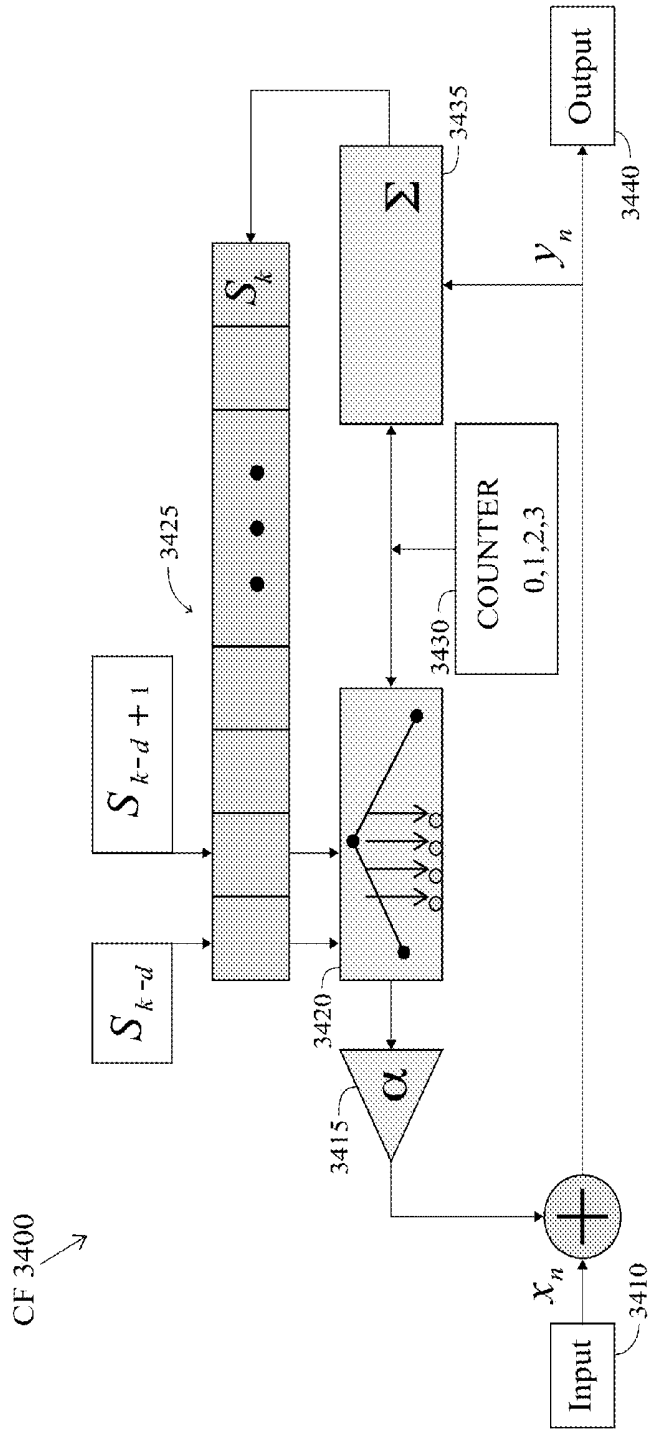

FIG. 24

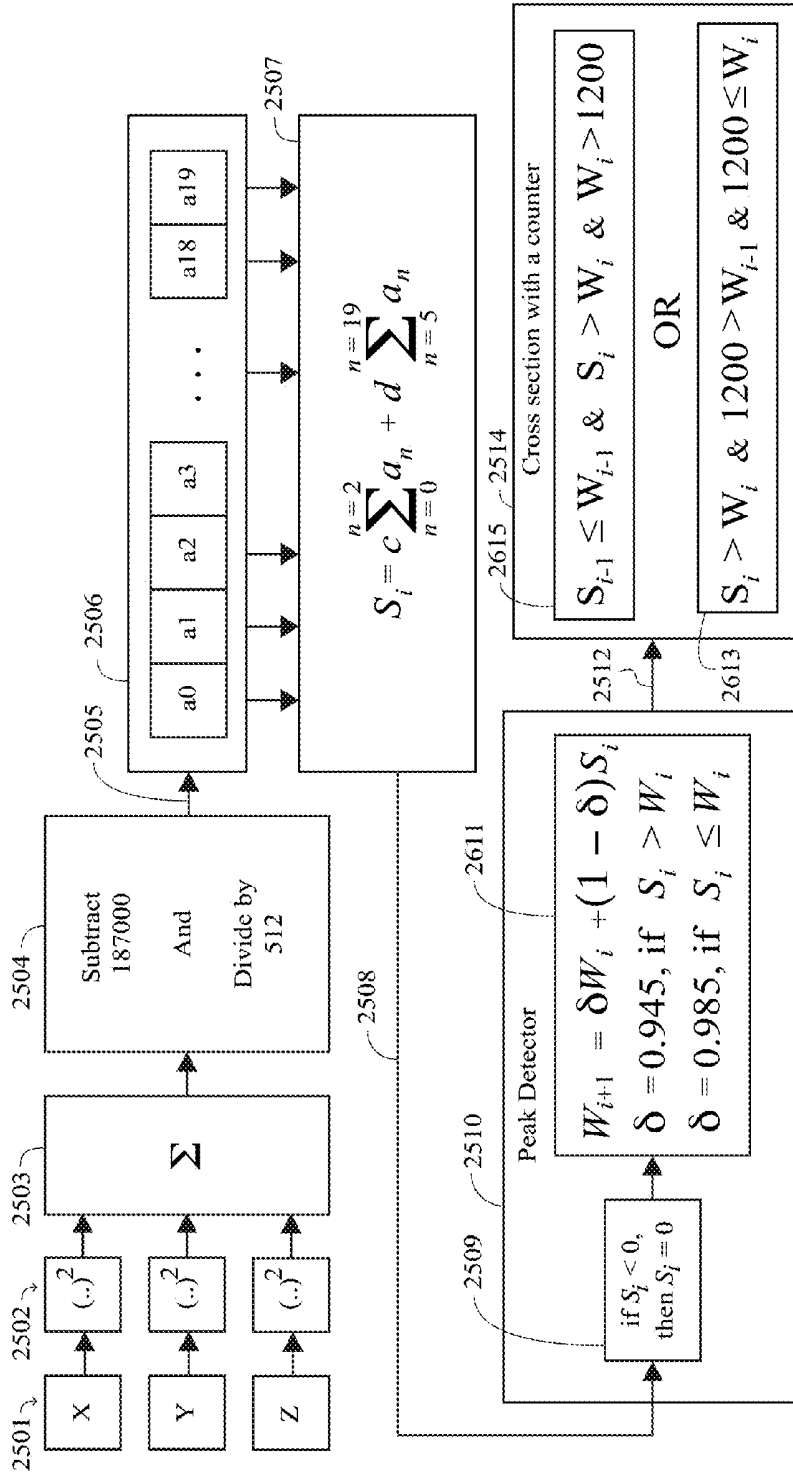

FIG. 25



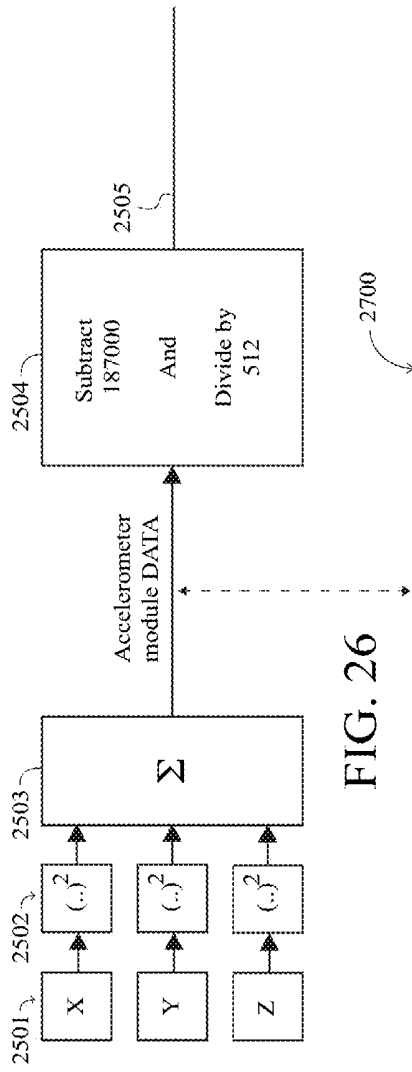

FIG. 26

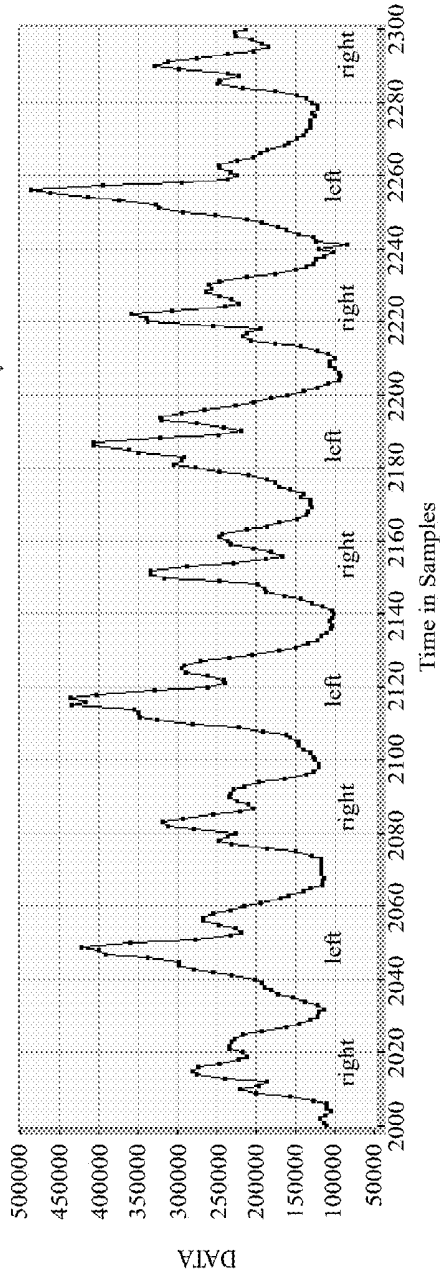

FIG. 26A

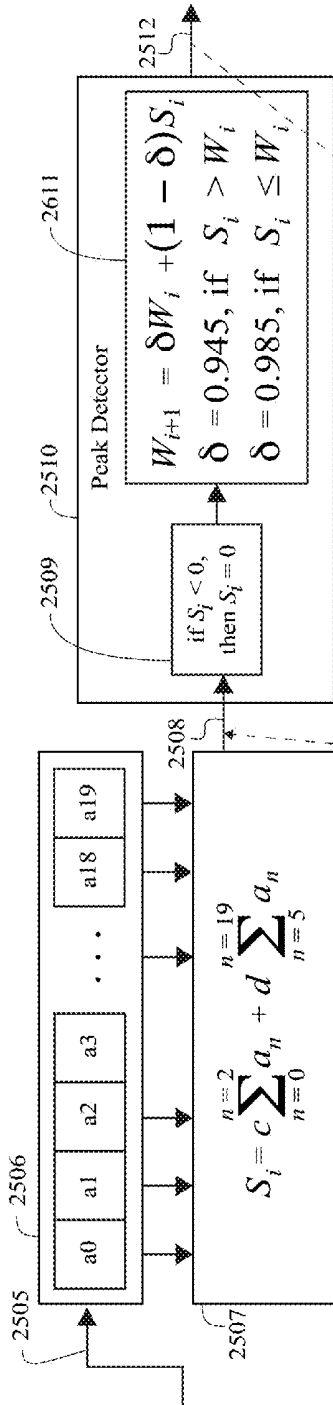

FIG. 27

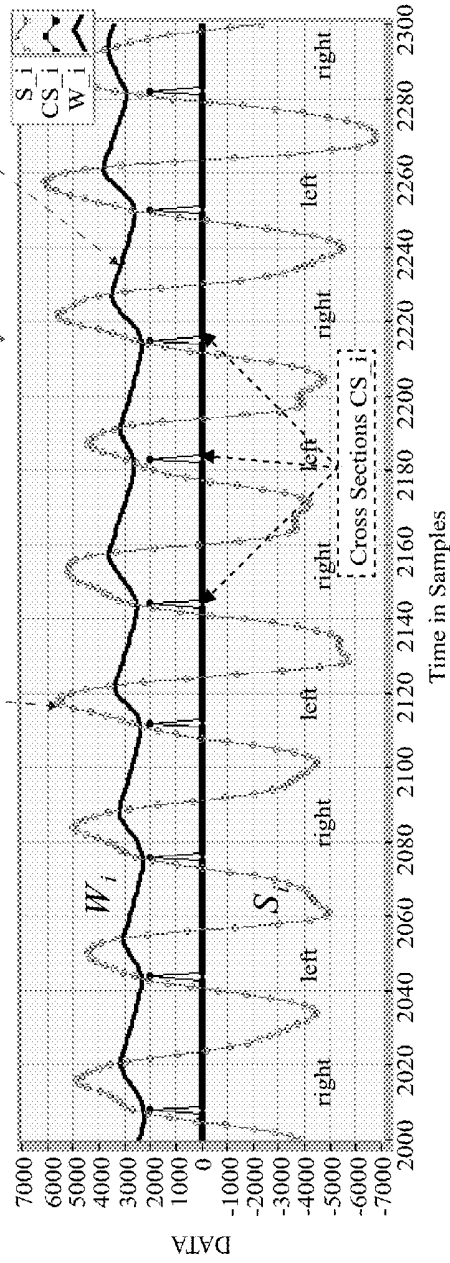

FIG. 27A

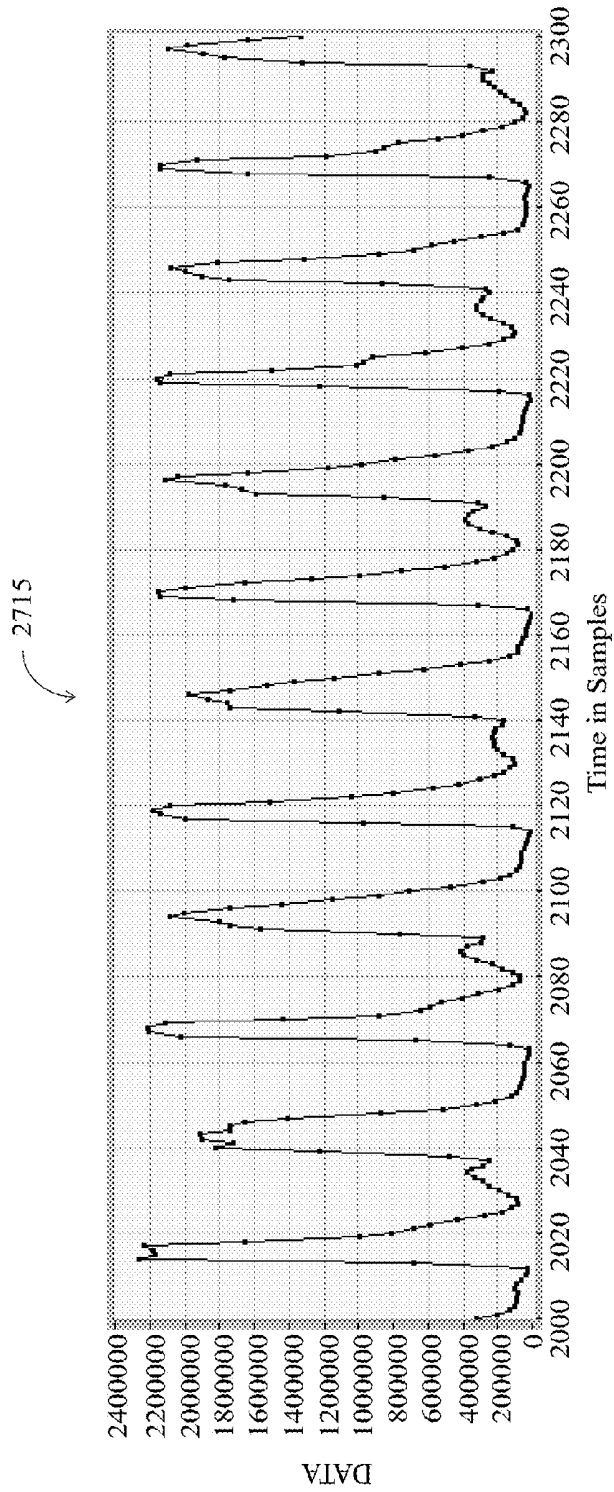

FIG. 28

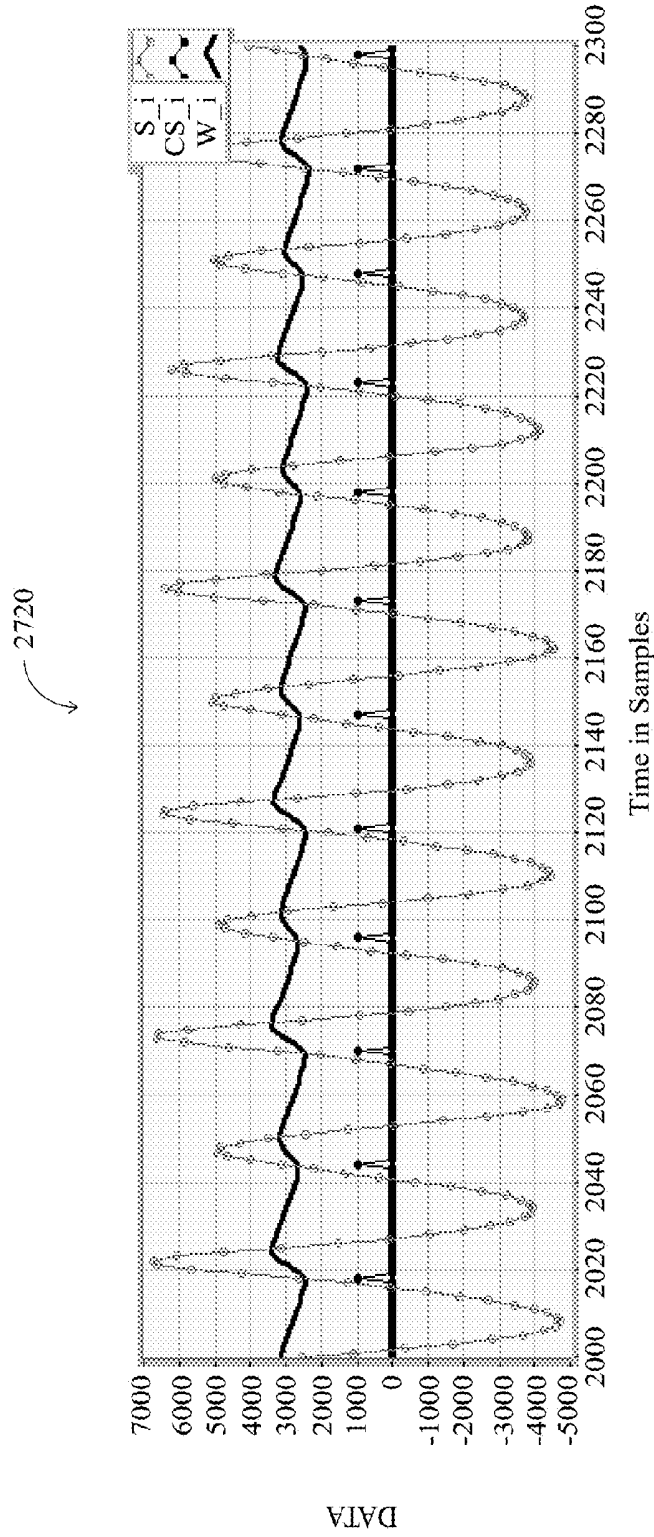

FIG. 29

## MONITORING DEVICE WITH A PEDOMETER

### CROSS REFERENCES TO RELATED APPLICATIONS

The Present Application is a continuation application of U.S. patent application Ser. No. 13/913,416, filed on Jun. 8, 2013, which is a continuation application of U.S. patent application Ser. No. 13/712,992, filed on Dec. 13, 2012, now U.S. Pat. No. 8,460,197, issued on Jun. 11, 2013, which is a continuation application of U.S. patent application Ser. No. 13/494,084, filed on Jun. 12, 2012, which claims priority to U.S. Provisional Patent Application No. 61/496,046, filed Jun. 13, 2011, all of which are hereby incorporated by reference in their entireties.

### STATEMENT REGARDING FEDERALLY SPONSORED RESEARCH OR DEVELOPMENT

Not Applicable

### BACKGROUND OF THE INVENTION

#### 1. Field of the Invention

The present invention is related to real-time vital sign monitoring devices. More specifically, the present invention relates to a device for monitoring a user's vital signs and using an accelerometer to filter the vital sign signal.

#### 2. Description of the Related Art

There is a need to know how one is doing from a health perspective. In some individuals, there is a daily, even hourly, need to know one's health. The prior art has provided some devices to meet this need.

One such device is a pulse oximetry device. Pulse oximetry is used to determine the oxygen saturation of arterial blood. Pulse oximeter devices typically contain two light emitting diodes: one in the red band of light (660 nanometers) and one in the infrared band of light (940 nanometers). Oxyhemoglobin absorbs infrared light while deoxyhemoglobin absorbs visible red light. Pulse oximeter devices also contain sensors that detect the ratio of red/infrared absorption several hundred times per second. A preferred algorithm for calculating the absorption is derived from the Beer-Lambert Law, which determines the transmitted light from the incident light multiplied by the exponential of the negative of the product of the distance through the medium, the concentration of the solute and the extinction coefficient of the solute.

The major advantages of pulse oximetry devices include the fact that the devices are non-invasive, easy to use, allows for continuous monitoring, permits early detection of desaturation and is relatively inexpensive. The disadvantages of pulse oximetry devices are that it is prone to artifact, it is inaccurate at saturation levels below 70%, and there is a minimal risk of burns in poor perfusion states. Several factors can cause inaccurate readings using pulse oximetry including ambient light, deep skin pigment, excessive motion, fingernail polish, low flow caused by cardiac bypass, hypotension, vasoconstriction, and the like.

In monitoring one's health there is a constant need to know how many calories have been expended whether exercising or going about one's daily routine. A calorie is a measure of heat, generated when energy is produced in our bodies. The amount of calories burned during exercise is a measure of the total amount of energy used during a workout. This can be important, since increased energy usage through exercise helps reduce body fat. There are several means to measure this

expenditure of energy. To calculate the calories burned during exercise one multiplies the intensity level of the exercise by one's body weight (in kilograms). This provides the amount of calories burned in an hour. A unit of measurement called a MET is used to rate the intensity of an exercise. One MET is equal to the amount of energy expended at rest.

For example, the intensity of walking 3 miles per hour ("mph") is about 3.3 METS. At this speed, a person who weighs 132 pounds (60 kilograms) will burn about 200 calories per hour ( $60 \times 3.3 = 198$ ).

The computer controls in higher-quality exercise equipment can provide a calculation of how many calories are burned by an individual using the equipment. Based on the workload, the computer controls of the equipment calculate exercise intensity and calories burned according to established formulae.

The readings provided by equipment are only accurate if one is able to input one's body weight. If the machine does not allow this, then the "calories per hour" or "calories used" displays are only approximations. The machines have built-in standard weights (usually 174 pounds) that are used when there is no specific user weight.

There are devices that utilize a watch-type monitor to provide the wearer with heart rate as measured by a heartbeat sensor in a chest belt.

However, the prior art devices often suffer from noise, light and motion related problems. These problems are increased when the user participates in an athletic activity such as running. Further, attempting to correct one problem often creates additional problems such as increasing a sensor output which results in a shorter battery life.

The prior art has failed to provide a means for monitoring one's health that is accurate, easy to wear on one's body for extended time periods, allows the user to input information and control the output, and provides sufficient information to the user about the user's health. Thus, there is a need for a monitoring device that can be worn for an extended period and provide health information to a user.

### BRIEF SUMMARY OF THE INVENTION

The present invention provides a solution to the shortcomings of the prior art. The present invention is accurate, comfortable to wear by a user for extended time periods, allows for input and controlled output by the user, is light weight, and provides sufficient real-time information to the user about the user's health.

One aspect of the present invention is an arm-based pedometer. The pedometer has two surfaces and is worn on the arm of a user. The pedometer also includes an attached accelerometer that is configured to generate a signal, used as a pedometer function, to determine the distance the user traveled while wearing the pedometer.

The pedometer preferably includes an optical sensor that generates a signal corresponding to the user's heart rate (HR), a processor, a power source, and a short-range wireless transceiver for transmitting a real-time vital sign signal.

The optical sensor preferably includes a light-to-voltage photodetector capable of transmitting a digital signal, and at least one light emitting diode capable of radiating light ranging from 550 nanometers to 1100 nanometers.

Alternatively, the optical sensor preferably includes a light-to-frequency photodetector capable of transmitting a digital signal, and at least one light emitting diode capable of radiating light ranging from 600 nanometers to 1100 nanometers.

Alternatively, the optical sensor preferably includes a plurality of light-to-voltage photodetectors capable of transmitting a digital signal, and at least one light emitting diode capable of radiating light ranging from 550 nanometers to 1100 nanometers.

Alternatively, the optical sensor preferably includes a plurality of light-to-frequency photodetectors capable of transmitting a digital signal, and at least one light emitting diode capable of radiating light ranging from 550 nanometers to 1100 nanometers.

Alternatively, the optical sensor preferably includes a light-to-voltage photodetector capable of transmitting a digital signal, and at least one light emitting diode capable of radiating light at 567 nanometers.

The processor is preferably configured to perform a pedometer function.

The communication protocol that the short range wireless transceiver uses is preferably BLUETOOTH, PART 15, WiFi, Infrared, or ultrasound.

The accelerometer of the pedometer is preferably a 3-axis accelerometer.

The pedometer preferably includes an incorporated display device to display the pedometer data to the user.

The pedometer also preferably includes a way to control the input and output information displayed on the display device. The control method is situated on the exterior of the pedometer, such as a button.

Another aspect of the present invention is a system for monitoring several real-time vital signs of a user and providing a pedometer function. The system includes a monitoring device integrated into the user's clothing. The monitoring device includes an optical sensor to generate a real-time vital sign signal of the user's heart rate, an accelerometer, a processor configured to perform a pedometer function based on several signals from the accelerometer, a power source, and a short-range wireless receiver to transmit the real-time vital sign signals. The system also includes a receiving device, which includes a short-range wireless transceiver, a processor and a display screen.

The monitoring device of the system preferably measures real-time data for at least one vital sign of an infant. The device calculates the real-time heart rate data and transmits the data to the receiving device to be displayed on the display screen.

The receiving device of the system is preferably a base station for receiving signals from the monitoring device and for communicating the signals to the receiving device.

Yet another aspect of the present invention is a method for monitoring the distance a user travels. The method includes an arm-based accelerometer generating a digital signal based on the user's movement, a processor processing the digital signal to obtain a real-time pedometer value, and displaying the real-time value on the receiving device's display screen.

The method preferably includes an optical sensor that includes a pulsed infrared LED and a photodetector.

Alternatively, the method preferably includes an optical sensor that includes a pulsed infrared LED, a green light, and a photodetector.

The receiving device of the method is preferably a smart-phone.

Yet another aspect of the present invention is clothing for fitness applications or for integrated medical or rehabilitation monitoring purposes where a continuous heart rate is needed for mobile patients and a pedometer function is required. The clothing includes a monitoring device integrated into the user's clothing. The monitoring device includes an optical sensor to generate a real-time vital sign signal of the user's

heart rate, an accelerometer, a processor configured to perform a pedometer function based on several signals from the accelerometer, a power source, and a short-range wireless receiver to transmit the real-time vital sign signals.

The clothing is preferably a shirt, a bra, or pants.

Yet another aspect of the present invention is a device for gaming devices, including wireless connections to a game box. The device includes clothing and a monitoring device integrated into the clothing. The monitoring device includes an optical sensor to generate a real-time vital sign signal of the user's heart rate, an accelerometer, a processor configured to perform a pedometer function based on several signals from the accelerometer, a power source, and a short-range wireless receiver to transmit the real-time vital sign signals.

The game box is preferably an XBOX 360 KINECT system.

An optical sensor is preferably encased in an elastic material and placed on the user's arm or chest to pick up heart rate signals.

A power source of a device, clothing, or system is preferably a lithium ion or flexible lithium polymer type battery that is integrated into the clothing, optionally remote from the optical sensor and connected with wires integrated into the clothing.

A processor board of a device, clothing, or system is preferably integrated into the clothing using flexible circuitry.

Additionally, a processor board is preferably co-located with the sensor board or remotely placed for additional user comfort and connected to the sensor via wires embedded into the clothing.

Additionally, a processor board includes a three axis accelerometer that mitigates mechanical noise and serves as the engine for an integrated pedometer function.

Additionally, a processor board includes a way to transmit HR data to a separate receiver attached to the article of clothing or to an exercise machine, a PC, a smart phone or a personal data device or an IPAD tablet.

The means of transmission of a device, clothing, or system is preferably a 5 kHz inductive rod, a Part 15 radio such as Ant or other operating in the 433-910 MHz range or in the 2.4 GHz range, standard Blue Tooth 3.0 or Blue Tooth Low Energy (BT 4.0).

A display device of a device, clothing or system is preferably an OLED (Organic Light Emitting Diode), LCD or an array of LEDs, which is part of the main processor board or is placed on the arm or the wrist of the clothing for easy user viewing control and feedback. The display device is integrated into the fabric and connected by wiring, which is also integrated into the fabric.

A device, clothing or system preferably includes a GPS.

The components of a device, clothing, or system is preferably modular for removal when the clothing is cleaned and then reattached and hooked up to the circuitry and wiring integrated into the material.

Another aspect of the present invention is of the present invention is a device for monitoring a real-time vital sign of a user. The device includes an article, an optical sensor, an accelerometer, a processor and a display. The article is attached to user. The optical sensor connected to the article. The optical sensor generates a real-time digitized signal corresponding to a flow of blood through an artery of the user. The accelerometer is connected to the strap. The accelerometer generates real-time accelerometer data comprising an X-axis signal, a Y-axis signal and a Z-axis signal based on a movement of the user. The processor is connected to the article. The processor is also electrically connected to the optical sensor and the accelerometer. The processor is con-

figured to receive the real-time digitized signal from the optical sensor and configured to receive the real-time accelerometer data from the accelerometer. The processor is also configured to calculate the period of motion related harmonics from the real-time accelerometer data utilizing a repetitive motion pattern analyzer. The processor is also configured to modify the real-time digitized optical signal by suppressing the motion related harmonics calculated by the motion pattern analyzer to generate a modified optical signal. The processor is also configured to generate a real-time heart rate for the user from the modified optical signal. The display displays the real-time heart rate value for the user received from the processor.

Optionally, the modified optical signal is filtered with a narrow band filter adaptively tuned to a heart rate frequency calculated by a heart rate evaluator to generate the real-time heart rate for the user.

Preferably, the repetitive motion pattern analyzer comprises an array of Comb filters.

Preferably, the optical sensor comprises two green LEDs and a photodetector.

Having briefly described the present invention, the above and further objects, features and advantages thereof will be recognized by those skilled in the pertinent art from the following detailed description of the invention when taken in conjunction with the accompanying drawings.

#### BRIEF DESCRIPTION OF THE SEVERAL VIEWS OF THE DRAWINGS

FIG. 1 is a plan view of a preferred embodiment of a monitoring device worn by a user.

FIG. 2 is a side view of a monitoring device.

FIG. 3 is an interior surface plan view of a monitoring device.

FIG. 4 is a side view of a monitoring device.

FIG. 5 is an exterior surface view of a monitoring device.

FIG. 6 is an isolated view of the electrical components of a monitoring device.

FIG. 7 is isolated side view of the electrical components of a monitoring device.

FIG. 8 is an isolated exterior surface view of an optical sensor for a monitoring device.

FIG. 9 is an isolated top plan view of an optical sensor for a monitoring device.

FIG. 10 is an isolated cross section view of an optical sensor for a monitoring device.

FIG. 11 is an isolated cross section view of an optical sensor for a monitoring device with light reflecting off of an artery of a user.

FIG. 12 is a block diagram of electrical components for a monitoring device.

FIG. 13 is a block diagram of signal processing for a monitoring device.

FIG. 14 is a schematic flow chart of the signal acquisition step of the flow chart of FIG. 13.

FIG. 15 is an illustration of the waveforms of the data sampling during the signal processing method.

FIG. 16 is a graph illustrating the method and mechanism of controlling the intensity of the light source over time.

FIG. 17 is a flow chart of a signal processing method of the present invention.

FIG. 18 is a block diagram of signal processing for a monitoring device.

FIG. 19 is a block diagram of signal processing of a prior art device.

FIG. 20 is a block diagram of signal processing for a monitoring device.

FIG. 21 is a block diagram of a comb filter type 2 for signal processing.

FIG. 22 is a block diagram of a comb filter type 1 for signal processing.

FIG. 23 is a block diagram of a four-cycle comb filter type 1 with a filter delay for signal processing.

FIG. 24 is a block diagram of a four-cycle comb filter type 1 with a filter delay for signal processing.

FIG. 25 is a block diagram of the pedometer function of the monitoring device.

FIG. 26 is a block diagram of an isolated portion of the pedometer function of the monitoring device.

FIG. 26A is a graph of data versus time in samples for information from the accelerometer as shown in FIG. 26.

FIG. 27 is a block diagram of signal processing of the pedometer function of the monitoring device.

FIG. 27A is a graph of data versus time in samples for information during the signal processing as shown in FIG. 27.

FIG. 28 is a graph of data versus time in samples for information.

FIG. 29 is a graph of data versus time in samples for information.

#### DETAILED DESCRIPTION OF THE INVENTION

As shown in FIGS. 1-5, a monitoring device is generally designated 20. The monitoring device 20 preferably includes an article 25 and an attachment band 26 having an exterior surface 26a and interior surface 26b. The monitoring device 20 is preferably secured with VELCRO® hook and loop material 31a and 31b. The article 25 preferably includes an optical sensor 30, control components 43a-43c and optionally a display member 40. The monitoring device 20 is preferably worn on a user's wrist, arm or ankle.

The article 25 preferably has a USB port for a wired connection to a computer, tablet, video monitor or mobile communication device such as smartphone.

It is desirous to adapt the monitoring device 20 to the anatomy of the user's arm or even the user's ankle. The band 26 is preferably composed of neoprene, leather, synthetic leather, LYCRA, another similar material, or a combination thereof. The article 25 is preferably composed of a semi-rigid or rigid plastic with a rubber-like or semi-flex plastic bottom layer for contact with the user's body. The bottom layer of the article 25 may have a curve surface for contact with a user's body. The article 25 preferably has a mass ranging from 5 grams to 50 grams. Preferably, the lower the mass of the article 25, the more comfort to the user. The article 25 preferably has a thickness ranging from 5 mm to 10 mm, and is most preferably 6.5 mm.

Although the monitoring device 20 is described in reference to an article worn on a user's arm, wrist or ankle, those skilled in the pertinent art will recognize that the monitoring device 20 may take other forms such as eyewear disclosed in Brady et al, U.S. Pat. No. 7,648,463, for a Monitoring Device, Method And System, which is hereby incorporated by reference in its entirety or a glove such as disclosed in Rulkov et al., U.S. Pat. No. 7,887,492, for a Monitoring Device, Method And System, which is hereby incorporated by reference in its entirety.

The optical sensor 30 of the monitoring device 20 is preferably positioned over the radial artery or ulnar artery if the article 25 is worn on the user's arm. The optical sensor 30 of the monitoring device 20 is preferably positioned over the posterior tibial artery of a user if the article 25 is worn on the

user's ankle. However, those skilled in the pertinent art will recognize that the optical sensor may be placed over other arteries of the user without departing from the scope and spirit of the present invention. Further, the optical sensor **30** need only be in proximity to an artery of the user in order to obtain a reading or signal.

In a preferred embodiment, the optical sensor **30** is a plurality of light emitting diodes ("LED") **35** based on green light wherein the LEDs **35** generate green light (wavelength of 500-570 nm), and a photodetector **36** detects the green light. Yet in an alternative embodiment, the optical sensor **30** is a photodetector **36** and a single LED **35** transmitting light at a wavelength of approximately 900 nanometers as a pulsed infrared LED. Yet further, the optical sensor is a combination of a green light LED and a pulsed infrared LED to offset noise affects of ambient light and sunlight. As the heart pumps blood through the arteries in the user's arm, ankle or wrist, the photodetector **36**, which is typically a photodiode, detects reflectance/transmission at the wavelengths (green, red or infrared), and in response generates a radiation-induced signal.

A preferred optical sensor **30** utilizing green light is a TRS1755 sensor from TAOS, Inc of Plano Tex. The TRS1755 comprises a green LED light source (567 nm wavelength) and a light-to-voltage converter. The output voltage is directly proportional to the reflected light intensity. Another preferred photodetector **36** is a light-to-voltage photodetector such as the TSL260R and TSL261, TSL261R photodetectors available from TAOS, Inc of Plano Tex. Alternatively, the photodetector **36** is a light-to-frequency photodetector such as the TSL245R, which is also available from TAOS, Inc. The light-to-voltage photodetectors have an integrated transimpedance amplifier on a single monolithic integrated circuit, which reduces the need for ambient light filtering. The TSL261 photodetector preferably operates at a wavelength greater than 750 nanometers, and optimally at 940 nanometers, which would preferably have a LED that radiates light at those wavelengths.

In one embodiment, discussed below, the display member **40** is removed and the signal is sent to a device such as a personal digital assistant, laptop computer, mobile telephone, exercise equipment, or the like for display and even processing of the user's real-time vital signs information. Alternatively, the circuitry assembly includes a flexible microprocessor board which is a low power, micro-size easily integrated board which provides blood oxygenation level, pulse rate (heart rate), signal strength bargraph, plethysmogram and status bits data. The microprocessor can also store data. The microprocessor can process the data to display pulse rate, blood oxygenation levels, calories expended by the user of a pre-set time period, target zone activity, time and dynamic blood pressure. Further, microprocessor preferably includes an automatic gain control for preventing saturation of the photodetector, which allows for the device to be used on different portions of the human body.

The display member **40** is preferably a light emitting diode ("LED"). Alternatively, the display member **40** is a liquid crystal display ("LCD") or other similar display device.

A microprocessor processes the signal generated from the optical sensor **30** to generate the plurality of vital sign information for the user which is displayed on the display member **40**. The control components **43a-c** are connected to the processor to control the input of information and the output of information displayed on the display member **40**.

The monitoring device **20** is preferably powered by a power source positioned on the article **25**. Preferably the power source is a battery. The power source **360** is preferably

an AA or AAA disposable or rechargeable battery. The power source is alternatively a lithium ion rechargeable battery such as available from NEC-Tokin. The power source preferably has an accessible port for recharging. The circuit assembly of the monitoring device preferably requires 5 volts and draws a current of 20- to 40 milliamps. The power source preferably provides at least 900 milliamp hours of power to the monitoring device **20**.

A connection wire arrangement **45** is shown in FIGS. **6** and **8**, wherein the connection **45** between the microprocessor and the optical sensor **30** is preferably non-planar or non-straight in order to reduce noise in the signal. The optical sensor **30** preferably comprises a photodetector **36**, and first and second LEDs **35** which transmit light. Using two LEDs on each side of a photodetector creates a more mechanically stable optical sensor **30**.

The monitoring device **20** alternatively has a short-range wireless transceiver which is preferably a transmitter operating on a wireless protocol, e.g. BLUETOOTH, part-15, or 802.11. "Part-15" refers to a conventional low-power, short-range wireless protocol, such as that used in cordless telephones. Other communication protocols include a part 15 low power short range radio, standard BLUETOOTH or BLUETOOTH Low Energy to conserve power or other low power short range communications means. The short-range wireless transmitter (e.g., a BLUETOOTH transmitter) receives information from the microprocessor and transmits this information in the form of a packet through an antenna. An external laptop computer or hand-held device features a similar antenna coupled to a matched wireless, short-range receiver that receives the packet. In certain embodiments, the hand-held device is a cellular telephone with a Bluetooth circuit integrated directly into a chipset used in the cellular telephone. In this case, the cellular telephone may include a software application that receives, processes, and displays the information. The secondary wireless component may also include a long-range wireless transmitter that transmits information over a terrestrial, satellite, or 802.11-based wireless network. Suitable networks include those operating at least one of the following protocols: CDMA, GSM, GPRS, Mobitex, DataTac, iDEN, and analogs and derivatives thereof. Alternatively, the handheld device is a pager or PDA.

A general method is as follows. The light source **35** transmits light through at least one artery of the user. The photodetector **36** detects the light. The pulse rate is determined by the signals received by the photo-detector **36**.

This information is sent to the microprocessor for creation of user's real-time pulse rate. The microprocessor further processes the information to display pulse rate, calories expended by the user of a pre-set time period, target zones of activity, time and/or dynamic blood pressure. The information is displayed on a display member or electro-optical display.

In a preferred embodiment, the article **25** has four control buttons **43a-d** as shown in FIGS. **1** and **5**. The control buttons **43a-d** are preferably positioned in relation to the display member **40** to allow the user immediate visual feedback of the user's inputted information. The middle control button **43b** preferably activates and deactivates the article **25**. The left button **43a** is preferably used to scroll through the different modes. The right button **43c** is preferably used to input data. The control buttons **43a-d** allow for the user's personal data to be entered and for choices to be selected by the user. The left button **43a** preferably allows for the user's calories burned to be displayed on the display member **40** and for the activity to be reset, and allows for other fitness monitoring features to be displayed.



To activate the article **25**, the middle button **43b** is depressed for preferably 0.5 seconds and then released. The display member will appear with a current pulse of the user and a calories burned display. The microprocessor preferably stores the calories burned and accumulates the values for a daily calories burned value and a total calories burned value until the activity is reset.

To enter the user's personal data, the middle button **43b** is depressed for 2 seconds and then released. The user will enter gender, age, mass, height and resting heart rate. Entering the data entails pushing the middle button to select a category (gender, age, . . . ) and then pushing the right or left button to scroll through the available options or to enter a value (e.g. age of the user). The middle button **43b** is pressed again to save the entry. This process is preformed until the user's has entered all of the data that the user wishes to enter into the microprocessor. The display member **40** will then display a heart rate and current calories burned value. A preset resting heart rate for men and women is preferably stored on the microprocessor, and used as a default resting heart rate. However, the user may enter their own resting heart rate value if the user is aware of that value. To access daily calories, the left button **43a** is pushed by the user and the display member **40** will illustrate the value for daily calories burned by the user. If the left button **43a** is pushed again, the value for total calories burned by the user will be displayed on the display member **40**. The left button **43a** is pushed again to return to a heart rate value on the display member **40**.

The right button **43c** is pushed to scroll through the choices of other output values, which comprises: basal metabolic rate; average heart rate; minimum heart rate; maximum heart rate; fat burn heart rate exercise target zone; cardio burn heart rate exercise target zone; and, summary of daily calories burned. The basal metabolic rate (displayed as "BMR") is an estimate of the total calories burned by the user in one day without exercise, and is based on the user inputted personal data. The average heart rate (displayed as "avHR") is the average heart rate of the user between resets, and is an overall indicator of fitness. The lower the average heart rate, the healthier the heart. The average heart rate is also a measure of the effectiveness of the exercise program employed by the user since a decrease in the average heart rate of the user will indicate the user's fitness has improved. The minimum heart rate (displayed as "mnHR") of the user is typically measured during sleep and periods of relaxation. The maximum heart rate (displayed as "mxHR") is typically measured during intense workouts. The fat burn heart rate exercise target zone (displayed as "fatB") displays a low and high range for the heart rate of the user to optimize fat burning during exercise. The cardio burn heart rate exercise target zone provides a high and low range for the heart rate of the user to optimize cardio conditioning during exercise. The summary of daily calories burned (displayed as "cal") displays the daily calories burned by the user.

In a preferred embodiment, the accelerometer is a multiple-axis accelerometer, such as the ADXL202 made by Analog Devices of Norwood, Mass. This device is a standard micro-electronic-machine ("MEMS") module that measures acceleration and deceleration using an array of silicon-based structures.

In yet another embodiment, the monitoring device **20** comprises a first thermistor, not shown, for measuring the temperature of the user's skin and a second thermistor, not shown, for measuring the temperature of the air. The temperature readings are displayed on the display member **40** and the skin temperature is preferably utilized in further determining the calories expended by the user during a set time period. One

such commercially available thermistor is sold under the brand LM34 from National Semiconductor of Santa Clara, Calif. A microcontroller that is utilized with the thermistor is sold under the brand name ATmega 8535 by Atmel of San Jose, Calif.

The monitoring device **20** may also be able to download the information to a computer for further processing and storage of information. The download may be wireless or through cable connection. The information can generate an activity log or a calorie chart.

The microprocessor can use various methods to calculate calories burned by a user. One such method uses the Harris-Benedict formula. The Harris-Benedict formula uses the factors of height, weight, age, and sex to determine basal metabolic rate (BMR). This equation is very accurate in all but the extremely muscular (will underestimate calorie needs) and the extremely overweight (will overestimate caloric needs) user.

The equations for men and women are set forth below:

$$\text{Men: BMR} = 66 + (13.7 \times \text{mass (kg)}) + (5 \times \text{height (cm)}) - (6.8 \times \text{age (years)})$$

$$\text{Women: BMR} = 655 + (9.6 \times \text{mass}) + (1.8 \times \text{height}) - (4.7 \times \text{age})$$

The calories burned are calculated by multiplying the BMR by the following appropriate activity factor: sedentary; lightly active; moderately active; very active; and extra active.

Sedentary=BMR multiplied by 1.2 (little or no exercise, desk job)

Lightly active=BMR multiplied by 1.375 (light exercise/sports 1-3 days/wk)

Moderately Active=BMR multiplied by 1.55 (moderate exercise/sports 3-5 days/wk)

Very active=BMR multiplied by 1.725 (hard exercise/sports 6-7 days/wk)

Extra Active=BMR multiplied by 1.9 (hard daily exercise/sports & physical job or 2x day training, marathon, football camp, contest, etc.)

Various target zones may also be calculated by the microprocessor. These target zones include: fat burn zone; cardio zone; moderate activity zone; weight management zone; aerobic zone; anaerobic threshold zone; and red-line zone.

$$\text{Fat Burn Zone} = (220 - \text{age}) \times 60\% \text{ \& } 70\%$$

An example for a thirty-eight year old female:

i.  $(220 - 38) \times 0.6 = 109$

ii.  $(220 - 38) \times 0.7 = 127$

iii. Fat Burn Zone between 109 to 127 heart beats per minute.

$$\text{Cardio Zone} = (220 - \text{your age}) \times 70\% \text{ \& } 80\%$$

An example for a thirty-eight year old female:

i.  $(220 - 38) \times 0.7 = 127$

ii.  $(220 - 38) \times 0.8 = 146$

iii. Cardio zone is between 127 & 146 heart beats per minute.

Moderate Activity Zone, at 50 to 60 percent of your maximum heart rate, burns fat more readily than carbohydrates. That is the zone one should exercise at if one wants slow, even conditioning with little pain or strain.

Weight Management Zone, at 60 to 70 percent of maximum, strengthens ones heart and burns sufficient calories to lower one's body weight.

Aerobic Zone, at 70 to 80 percent of maximum, not only strengthens one's heart but also trains one's body to process oxygen more efficiently, improving endurance.

Anaerobic Threshold Zone, at 80 to 90 percent of maximum, improves one's ability to rid one's body of the lactic acid buildup that leads to muscles ache near one's performance limit. Over time, training in this zone will raise one's limit.

Red-Line Zone, at 90 to 100 percent of maximum, is where serious athletes train when they are striving for speed instead of endurance.

#### Example One

Female, 30 yrs old, height 167.6 centimeters, weight 54.5 kilograms.

The BMR=655+523+302-141=1339 calories/day.

The BMR is 1339 calories per day. The activity level is moderately active (work out 3-4 times per week). The activity factor is 1.55. The TDEE=1.55×1339=2075 calories/day. TDEE is calculated by multiplying the BMR of the user by the activity multiplier of the user.

The heart rate may be used to dynamically determine an activity level and periodically recalculate the calories burned based upon that factor. An example of such an activity level look up table might be as follows:

#### Activity/Intensity Multiplier Based on Heart Rate

Sedentary=BMR×1.2 (little or no exercise, average heart rate 65-75 bpm or lower)

Lightly active=BMR×3.5 (light exercise, 75 bpm-115 bpm)

Mod. active=BMR×5.75 (moderate exercise, 115-140 pm)

Very active=BMR×9.25 (hard exercise, 140-175 bpm)

Extra active=BMR×13 (175 bpm-maximum heart rate as calculated with MHR formula)

For example, while sitting at a desk, a man in the above example might have a heart rate of between 65 and 75 beats per minute (BPM). (The average heart rate for an adult is between 65 and 75 beats per minute.) Based on this dynamically updated heart rate his activity level might be considered sedentary. If the heart rate remained in this range for 30 minutes, based on the Harris-Benedict formula he would have expended 1.34 calories a minutex1.2 (activity level)×30 minutes, which is equal to 48.24 calories burned.

If the man were to run a mile for 30 minutes, with a heart rate ranging between 120 and 130 bpm, his activity level might be considered very active. His caloric expenditure would be 1.34 calories a minutex9.25 (activity level)×30 minutes, which is equal to 371.85.

Another equation is weight multiplied by time multiplied by an activity factor multiplied by 0.000119.

FIG. 13 illustrates a block diagram of a flow chart of a signal processing method of the present invention. As shown in FIG. 10, the photodetector 36 of the optical sensor 30 receives light from the light source 35 while in proximity to the user's artery. The light source 35 is preferably a plurality of LEDs 35. The intensity of the light is preferably controlled by an integrator 300. In a preferred embodiment, the optical sensor 30 is a TRS1755 which includes a green LED light source (567 nm wavelength) and a light-to-voltage converter. The output voltage is directly proportional to the reflected light intensity. The signal 299 is sent to the microprocessor. At block 1300, the signal acquisition is performed. In reference to FIGS. 14 and 15, in the pulse mode the LED 35 is periodically activated for short intervals of time by a signal from the

microcontroller. The reflected pulse of light is received by the sensor, with the generation of a voltage pulse having an amplitude proportional to the intensity of the reflected light. When the LED is activated, the switch, SW, is open by the action of the control signal from the microcontroller, and the capacitor, C, integrates the pulse generated from the sensor by charging through the resistor R. Immediately prior to deactivation of the LED, the analog-to-digital converter acquires the value of the voltage integrated across the capacitor, C. The analog-to-digital converter generates a data sample in digital form which is utilized by the microcontroller for evaluation of the heart rate the wearer. Subsequent to the sample being acquired by the analog-to-digital converter, the LED is deactivated and the capacitor, C, is shortcut by switch, SW, to reset the integrator, RC. A signal indicating sensor saturation is also sent to the microcontroller for light control of the LEDs. This states remains unchanged for a given time interval after which the process is repeated, which is illustrated in FIG. 15. The signals are shown in FIG. 15, with the raw sensor signal received from the sensor amplifier shown as varying between reflected light when the LEDs are on and an ambient light level when the LEDs are off. The filtered signal from the high pass filter ("HPF") is shown as the filtered sensor signal in FIG. 14. The integrator reset signal is shown as integrator out signal in FIG. 15, and the integrator reset signal in FIG. 14.

At block 1305, a band pass filter is implemented preferably with two sets of data from the analog-to-digital converter. At block 1305, an average of the values of data samples within each of a first set of samples is calculated by the microprocessor. For example, the values of data samples within forty-four samples are summed and then divided by forty-four to generate an average value for the first set of samples. Next, an average of the values of data samples within a second set of samples is calculated by the microprocessor. For example, the values of data samples within twenty-two samples are summed and then divided by twenty-two to generate an average value for the second set of samples. Preferably, the second set of samples is less than the first set of samples. Next, the average value of the second set of samples is subtracted from the average value for the first set of samples to generate a first filtered pulse data value.

At block 1310, the filtered pulse data value is processed using a heart rate evaluation code to generate a first heart rate value. In a preferred method, the heart rate evaluation code obtains the heart rate by calculating the distance between crossing points of the voltage through zero. Once the first heart rate value is known, then an adaptive resonant filter is utilized to generate a filtered second heart rate value by attenuating interference caused by motion artifacts. At block 1315, a sample delay is computed as the period of evaluated heart rate divided by two.

At block 1320, preferably a two cascade adaptive resonant filter generates a second filtered pulse data value which is processed at block 1310 using the heart rate evaluation code to generate a second heart rate value. Those skilled in the pertinent art will recognize that three, four, or more, cascade adaptive resonant filters may be utilized in generating the second filtered pulse data value. Essentially, the highest and lowest values are disregarded in calculating the filtered second heart rate value. Alternatively, a phase is established and any values outside of the phase are disregarded in calculating the second heart rate value. The filtering is preferably continued during the use of the monitor thereby further refining the heart rate value of the user.

A motion sensor 1100 is included to assist in identifying motion noise and filtering the noise from the signal sent by the sensor 30. The motion sensor 1100, such as an accelerometer,

is integrated into the circuitry and software of the monitoring device 20. As the motion sensor detects an arm swinging, the noise component is utilized with the signal processing noise filtering techniques to provide additional filtering to remove the noise element and improve the accuracy of the monitoring device 20. More specifically, the signal from the optical sensor 30 is transmitted to the processor where a custom blood pressure filter 41w processes the signal which is further processed at by custom adaptive filter 41x before being sent to a heart beat tracking system 41y and then transmitted to a heart rate beat output 41z. The heart rate beat output 41z provides feedback to the custom adaptive filter 41x which also receives input from the motion sensor 1100.

FIG. 17 is a preferred method 500 for controlling the light intensity of the optical sensor 30. At block 505, the light intensity of the light source 35 is monitored. At block 510, the sensor/photodetector is determined to be saturated by the light source. At block 515, the intensity of the light source is modified by adjusting the resistance and the flow of current to the light source 35. At block 520, the light intensity is again monitored and adjusted if necessary. In a preferred embodiment, this automatic gain mechanism prevents the green light from overwhelming the photodetector 36 thereby maintaining an accurate reading no matter where the optical sensor is placed on the user.

FIG. 16 illustrates how the control mechanism operates to maintain a proper light intensity. As the signal reaches the upper limit, the photodetector becomes saturated and the processor lowers the current flow, which results in a break in the signal. Then as the signal is lowered it becomes too low and the processor increases the light intensity resulting in a break in the signal.

A block diagram for vital sign signal processing is shown in FIG. 18. The optical sensor 730 is placed on or near an artery 90 of a user of the monitoring device 20. The optical sensor 730 has a pair of LEDs 735 and a photodetector 736, which receives reflected light 737 from the LEDs 735. The microprocessor 741 has a LED control 715 connected to DAC 702 for controlling the intensity of the LEDs 737. The signal from the photodetector 736 is transmitted to a high pass filter (HPF) 703 which sends it to an analog to digital converter 704, and the signal from the photodetector 737 is also sent directly to a second analog to digital converter 704. The real-time signal is then sent to a sensor data evaluation 714 to provide feedback to the LED control 715, and then is also sent to the filter of the signal processing for mitigations of noise and heart rate evaluations 712. Simultaneously, the accelerometer 710 transmits X-axis, Y-axis and Z-axis signals for the motion of the monitoring device 20 to an accelerometer data evaluation 711 of the microprocessor 741. This signal is then sent to the signal processing for mitigations of noise and heart rate evaluations 712. The output for the heart rate and/or calories is generated at block 713 of the microprocessor 741, which then sends the results to the display 740.

FIG. 19 illustrates a prior art signal processing of a vital sign without the use of an accelerometer to filter the signal. As shown in FIG. 19, sensor data at block 2100 is sent to a band pass filter 2110 and then to a comb filter 2115 and to a heart rate evaluator 2125 through a switch 2120. Feedback from the heart rate evaluator 2125 is sent to comb filter 2115, such as described in Brady et al., U.S. Pat. No. 7,468,036 for a Monitoring Device, Method And System, which is hereby incorporated by reference in its entirety.

FIG. 20 illustrates signal processing of a vital sign with the use of an accelerometer to filter the signal. As shown in FIG. 20, sensor data at block 2100 is sent to a band pass filter 2110 and then to a comb filter 2165 for noise suppression, then to a

Comb filter for a heart rate 2215 and to a heart rate evaluator 2125 through a switch 2120. Feedback from the heart rate evaluator 2125 is sent to comb filter 2115. However, accelerometer data from block 2150 is sent to an array of Comb filters 2155, then to a selection of a filter delay for mitigation of mechanical noise at 2160 and then to comb filter 2165 for noise suppression in the vital sign signal from the vital sign sensor.

FIG. 21 illustrates a type 2 Comb filter 3100 which is preferably used as the Comb filter for noise suppression 2165 of FIG. 20. The signals begin at input 3110. A delay is generated at 3120, sent to interpolator 3125 and gain 3130 and then a filter delayed signal is sent from output 3135.

FIG. 22 illustrates a type 1 Comb filter 3200 which is preferably used as the Comb filter for the heart rate 2115 of FIG. 20. The signals begin at input 3210. A delay is generated at 3225, sent to interpolator 3220 and gain 3215 and then a filter delayed signal is sent from output 3230.

FIG. 23 illustrates a four cycle Comb filter 3300 with a filter delay of 8, 12, 16, . . . , 4N, which is preferably used as at least one of the array of Comb filters 2155 of FIG. 20. The signals begin at input 3310. A collector 3335 sums the signals. A counter 3330 transmits signals to the collector and interpolator 3320. A delay is generated at 3325, sent to the interpolator 3320 and gain 3315 and then a filter delayed signal is sent from output 3340.

FIG. 24 illustrates a four cycle Comb filter 3400 with a filter delay of 10, 14, 18, . . . , 4N+2, which is preferably used as at least one of the array of Comb filters 2155 of FIG. 20. The signals begin at input 3410. A collector 3435 sums the signals. A counter 3430 transmits signals to the collector and interpolator 3420. A delay is generated at 3425, sent to the interpolator 3420 and gain 3415 and then a filter delayed signal is sent from output 3440.

FIGS. 9-11 illustrate the sensor 30. The sensor 30 has a photodetector 36, at least two LEDs 35 and an opaque light shield 57. The LEDs 35 are preferably green light LEDs. The sensor 30 preferably has a length, L, of 7-10 mm on each side, as shown in FIG. 9. The sensor 30 preferably has a height, H, of 1-1.5 mm, as shown in FIG. 10. The opaque light shield 57 blocks the direct light from the LEDs 35 to the photodetector 36. Only the green light diffused and translucent through the media (skin of the user) 61, as shown in FIG. 11, is allowed to enter the chamber of the photodetector 36. This provides for a more accurate heart rate or vital sign signal.

In a preferred design of the sensor 30, the distance between the centers of active areas of LEDs 35 is preferably 5-6 mm. The active area (photodetector 36) of a sensor 30 is placed in the middle of that distance. In the custom sensor, the distance of a custom sensor is preferably in the range of 3-4 mm (which means the spacing between the centers of photodetector 36 and LEDs 35 is about 1.5-2 mm). The distance is preferably sufficient for the placement of an opaque barrier between them. To control the amplitude of the LED intensity pulse a sufficient current (voltage) range of intensity ramp is used to control the LEDs 35 and to achieve the same levels of intensity in both LEDs 35 within a given range. The electrical characteristics of 520 nm SunLED in terms of voltage range for intensity ramp is sufficient. The top surface of the sensor 30 is preferably flat and in steady contact with the skin. Under a strong motion condition, the skin moves at the border of the contact surface. The sizes of the sensor area and flat skin contact area are selected to reduce the border motion effects. If the distance between the LEDs and sensor is reduced, a lighted area of the skin is smaller, and the contact area is reduced (5x5 mm is acceptable). LGA enables an easy way to seal the contact area from moisture. The preferred embodi-

ment uses 250 microsecond LED pulses and a 12T photodetector **36** with second order active high pass filter (100 Hz cutoff). The DC output of the sensor **30** is monitored to ensure that it is not saturated by the effects of ambient light. The use of short-term pulses reduces ambient light. In the preferred embodiment, voltage is collected at the sensor output every 2 msec. Inside the microprocessor **741**, an average 8 consecutive samples improve the SNR (signal to noise ratio) and then work with the averaged numbers. Therefore the sampling rate for raw data is preferably 2 msec, however if 8-samples averaging is utilized in the integrated sensor the data output rate is reduced to sending a new averaged value every 16 msec. An ADC is used with a 12-bit resolution. The response of TSL12T is acceptable. 100 Hz is the low limit for LPF cutoff. The selection of pulse duration is preferably based on the speed of the LED drivers, sensor electronics and output pick detection. The higher the low frequency cutoff that is implemented for the selected pulse duration, the better SNR.

Preferably, two reactance circuits work as load resistances for a photodiode, BPW34. The voltage drop at each reactance circuit is amplified by a differential amplifier, built with two 2N4416 FETs. The symmetrical design makes a diode bias voltage of about 2 V, which is nearly independent of ambient light conditions. The circuit is insensitive to common mode interference. The circuit operates using a single 5 volt power supply.

FIG. 12 is a functional block diagram for the signal processing **2000** of the sensor. A trigger input **2001** has a duration of 50-250 microseconds and a period of 2 milliseconds for input to a pulse generator **2004**, which also receives input from VDD **2002**. Input voltage for intensity control **2003** is sent to resistors **2005** and **2006** and to LEDs **2007** and **2008** and activated by switch **2009**. Ambient light filter and amplifier **2010** transmits to synchronized pick detector **2012** for a voltage or data output **2014** as an output signal **2016**.

As shown in FIGS. 25, 26, 26A, 27, 27A, 28 and 29, a pedometer function of the present invention is provided with input data from an accelerometer. As shown in FIG. 25, inputs X, Y and Z from the 3-axis accelerometer with digital outputs. Preferably 60 samples per seconds are taken. The inputs are squared and summed into a vector length, which has a gravity value of 187000 subtracted therefrom and is then divided by 512. This processing is sent to a first filter, and then to a second filter with an adoptive threshold. Then a cross-section of the lines as shown in FIG. 27 is used for counting.

From the foregoing it is believed that those skilled in the pertinent art will recognize the meritorious advancement of this invention and will readily understand that while the present invention has been described in association with a preferred embodiment thereof, and other embodiments illustrated in the accompanying drawings, numerous changes modification and substitutions of equivalents may be made therein without departing from the spirit and scope of this invention which is intended to be unlimited by the foregoing except as may appear in the following appended claim. Therefore, the embodiments of the invention in which an exclusive property or privilege is claimed are defined in the following appended claims.

We claim as our invention the following:

1. An arm-based pedometer comprising:

an optical sensor for generating a real-time vital sign signal corresponding to a real-time heart rate of a user, an accelerometer;

a processor configured to perform a pedometer function based on a plurality of signals from the accelerometer to generate a distance traveled by the user; and

wherein the optical sensor is an optical sensor comprising a light-to-voltage photodetector capable of transmitting a digital signal, and at least one light emitting diode capable of radiating light ranging from 550 nanometers to 1100 nanometers, an optical sensor comprising a light-to-frequency photodetector capable of transmitting a digital signal, and at least one light emitting diode capable of radiating light ranging from 600 nanometers to 1100 nanometers, an optical sensor comprising a plurality of light-to-voltage photodetectors capable of transmitting a digital signal, and at least one light emitting diode capable of radiating light ranging from 550 nanometers to 1100 nanometers, an optical sensor comprising a plurality of light-to-frequency photodetectors capable of transmitting a digital signal, and at least one light emitting diode capable of radiating light ranging from 550 nanometers to 1100 nanometers, or an optical sensor comprising a light-to-voltage photodetector capable of transmitting a digital signal, and at least one light emitting diode capable of radiating light from 500 nanometers to 570 nanometers.

2. The arm-based pedometer according to claim 1 further comprising a short range wireless transceiver for transmitting data from the arm-based pedometer.

3. The arm-based pedometer according to claim 1 wherein the accelerometer is a 3-axis accelerometer.

4. The arm-based pedometer according to claim 2 wherein the short range wireless transceiver of the monitoring device operates on a communication protocol using BLUETOOTH, PART 15, WiFi, Infrared, and ultrasound.

5. The arm-based pedometer according to claim 1 further comprising a display on the arm-based pedometer to display pedometer data for the user.

6. The arm-based pedometer according to claim 1 wherein the arm-based pedometer calculates a real-time heart rate for a user based on the optical signal.

7. The arm-based pedometer according to claim 1 further comprising means for controlling the input information and the output of information displayed on the visually displaying means, the controlling means disposed on the exterior surface of the article.

8. The arm-based pedometer according to claim 1 wherein the arm-based accelerometer is integrated into clothing for physical activity or for interactive gaming.

9. A system for monitoring a plurality of real-time vital signs of a user and providing a pedometer function, the system comprising:

a monitoring device worn on an arm of the user, the monitoring device having a first surface and a second surface, the monitoring device comprising  
an optical sensor for generating a real-time vital sign signal corresponding to the heart rate of the user,  
an accelerometer,

a processor configured to perform a pedometer function based on a plurality of signals from the accelerometer to generate a distance traveled by the user, and  
a short range wireless transceiver for transmitting data from the monitoring device; and

a receiving device comprising a short range wireless transceiver, a processor and a display screen;

wherein the optical sensor is an optical sensor comprising a light-to-voltage photodetector capable of transmitting a digital signal, and at least one light emitting diode capable of radiating light ranging from 550 nanometers to 1100 nanometers, an optical sensor comprising a light-to-frequency photodetector capable of transmitting a digital signal, and at least one light emitting diode

capable of radiating light ranging from 600 nanometers to 1100 nanometers, an optical sensor comprising a plurality of light-to-voltage photodetectors capable of transmitting a digital signal, and at least one light emitting diode capable of radiating light ranging from 550 nanometers to 1100 nanometers, an optical sensor comprising a plurality of light-to-frequency photodetectors capable of transmitting a digital signal, and at least one light emitting diode capable of radiating light ranging from 550 nanometers to 1100 nanometers, or an optical sensor comprising a light-to-voltage photodetector capable of transmitting a digital signal, and at least one light emitting diode capable of radiating light from 500 nanometers to 570 nanometer.

10. The system according to claim 9 wherein the receiver is a console for interactive gaming.

11. The system according to claim 9 wherein the arm-based accelerometer is integrated into clothing for physical activity or for interactive gaming.

12. The system according to claim 9 wherein the short range wireless transceiver of the monitoring device operates on a communication protocol using BLUETOOTH, PART 15, WiFi, Infrared, and ultrasound.

13. The system according to claim 9 wherein the monitoring device measures real-time data for the at least one vital sign of the user and transmits the real-time data to the receiving device to calculate at least a real-time heart rate data and display the real-time hear rate data on the display screen.

14. The system according to claim 9 wherein the system further comprises a base station for receiving signals from the monitoring device and for communicating the signals to the receiving device.

\* \* \* \* \*

专利名称(译)	带计数器的监控装置		
公开(公告)号	<a href="#">US9314166</a>	公开(公告)日	2016-04-19
申请号	US14/145833	申请日	2013-12-31
[标]申请(专利权)人(译)	冲击运动TECH		
申请(专利权)人(译)	冲击运动TECHNOLOGIES, INC.		
当前申请(专利权)人(译)	冲击运动TECHNOLOGIES, INC.		
[标]发明人	BRADY DONALD RULKOV NIKOLAI HUNT MARK		
发明人	BRADY, DONALD RULKOV, NIKOLAI HUNT, MARK		
IPC分类号	A61B5/0205 A61B5/00 A61B5/11 A61B5/024		
CPC分类号	A61B5/721 A61B5/0205 A61B5/002 A61B5/0082 A61B5/11 A61B5/6804 A61B5/742 A61B5/02416 A61B5/1118 A61B5/02427 A61B5/02055 A61B5/0017 A61B5/0024 A61B5/021 A61B5/02433 A61B5/02438 A61B5/0816 A61B5/1112 A61B5/112 A61B5/681 A61B2562/0219 G01C22/006		
代理人(译)	卡塔尼亚, MICHAEL		
优先权	13/712992 2013-06-11 US 61/496046 2011-06-13 US		
外部链接	<a href="#">Espacenet</a> <a href="#">USPTO</a>		

摘要(译)

本文公开了一种带有计数器的监测装置。监控设备优选地包括物品，光学传感器，加速度计和处理器。光学传感器优选地包括光电检测器和多个发光二极管。来自光学传感器的传感器信号用来自加速度计的滤波加速度计输出信号处理，以产生计数器功能。

