



US009801557B2

(12) **United States Patent**
Ghaffari et al.

(10) **Patent No.:** **US 9,801,557 B2**
(45) **Date of Patent:** **Oct. 31, 2017**

(54) **CATHETER OR GUIDEWIRE DEVICE INCLUDING FLOW SENSING AND USE THEREOF**

(58) **Field of Classification Search**
CPC ... A61B 5/026; A61B 5/4836; A61B 18/1492; A61B 18/18; A61B 18/02; A61N 1/32
See application file for complete search history.

(71) Applicant: **MC10, Inc.**, Lexington, MA (US)

(56) **References Cited**

(72) Inventors: **Roozbeh Ghaffari**, Cambridge, MA (US); **Stephen Lee**, Cambridge, MA (US); **John Work**, South Dennis, MA (US); **John A. Wright, Jr.**, Lexington, MA (US); **Lauren Klinker**, Cambridge, MA (US)

U.S. PATENT DOCUMENTS

3,716,861 A 2/1973 Root
3,805,427 A 4/1974 Epstein
(Continued)

(73) Assignee: **MC10, Inc.**, Lexington, MA (US)

FOREIGN PATENT DOCUMENTS

(*) Notice: Subject to any disclaimer, the term of this patent is extended or adjusted under 35 U.S.C. 154(b) by 0 days.

CN 1864095 11/2006
EP 0585670 A2 3/1994
(Continued)

(21) Appl. No.: **15/047,314**

OTHER PUBLICATIONS

(22) Filed: **Feb. 18, 2016**

Carvalho et al., "Electrochemical Detection in a Paper-Based Separation Device", *Analytical Chemistry*, vol. 82, No. 3, (1162-1165) (4 pages) (Jan. 7, 2010).

(65) **Prior Publication Data**

US 2016/0213262 A1 Jul. 28, 2016

(Continued)

Related U.S. Application Data

(63) Continuation of application No. 14/147,347, filed on Jan. 3, 2014, now Pat. No. 9,295,842, which is a
(Continued)

Primary Examiner — Robert N Wieland
(74) *Attorney, Agent, or Firm* — Nixon Peabody LLP

(51) **Int. Cl.**
A61B 18/04 (2006.01)
A61B 5/027 (2006.01)

(Continued)

(57) **ABSTRACT**

(52) **U.S. Cl.**
CPC *A61B 5/027* (2013.01); *A61B 5/6851* (2013.01); *A61B 18/1492* (2013.01);
(Continued)

Devices and methods are provided for performing procedure on tissue with flow monitoring using flow sensors. The devices include an elongated member, and at least one flow sensor disposed on the elongated member. The flow sensor includes at least one temperature sensor and at least one heating element having a cavity. At least a portion of the at least one temperature sensor is housed in the cavity. A temperature measurement of the temperature sensor provides an indication of the flow rate of a fluid proximate to the flow sensor.

23 Claims, 33 Drawing Sheets

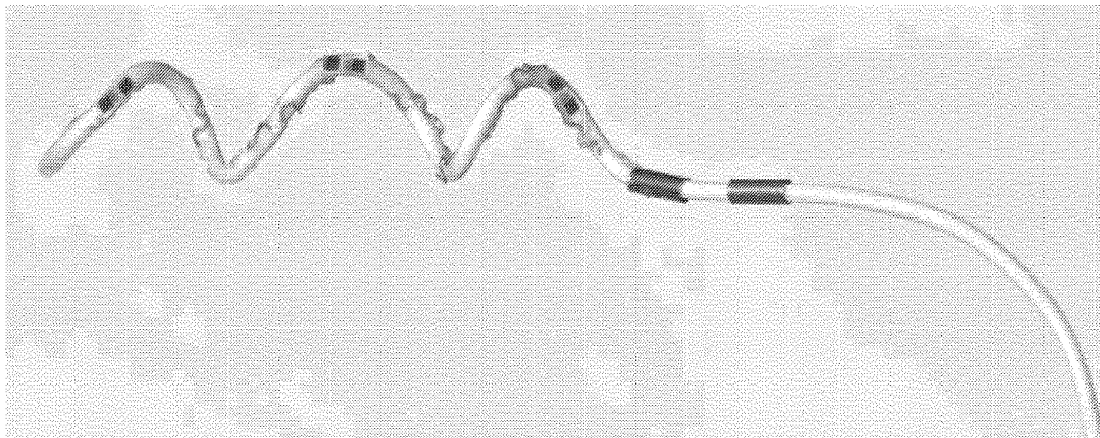

Related U.S. Application Data

	continuation-in-part of application No. 13/844,677, filed on Mar. 15, 2013, now Pat. No. 9,168,094.	5,439,575 A	8/1995	Thornton	
		5,454,270 A	10/1995	Brown	
		5,455,430 A	10/1995	Noguchi	
		5,471,982 A	12/1995	Edwards	
		5,477,088 A	12/1995	Rockett	
(60)	Provisional application No. 61/733,575, filed on Dec. 5, 2012, provisional application No. 61/728,653, filed on Nov. 20, 2012, provisional application No. 61/668,338, filed on Jul. 5, 2012.	5,491,651 A	2/1996	Janic	
		5,567,975 A	10/1996	Walsh	
		5,580,794 A	12/1996	Allen	
		5,617,870 A *	4/1997	Hastings	A61B 5/028 600/505
		5,811,790 A	9/1998	Endo	
(51)	Int. Cl.	5,817,008 A	10/1998	Rafert	
	<i>A61N 1/36</i> (2006.01)	5,907,477 A	5/1999	Tuttle	
	<i>A61B 34/35</i> (2016.01)	6,063,046 A	5/2000	Allum	
	<i>A61B 90/70</i> (2016.01)	6,148,127 A	11/2000	Adams	
	<i>A61B 18/14</i> (2006.01)	6,265,090 B1	7/2001	Nishide	
	<i>A61N 1/05</i> (2006.01)	6,282,960 B1	9/2001	Samuels	
	<i>A61B 90/30</i> (2016.01)	6,343,514 B1 *	2/2002	Smith	A61B 5/0215 374/E1.008
	<i>A61B 5/00</i> (2006.01)	6,387,052 B1	5/2002	Quinn	
	<i>A61B 18/00</i> (2006.01)	6,410,971 B1	6/2002	Otey	
	<i>A61B 34/00</i> (2016.01)	6,421,016 B1	7/2002	Phillips	
	<i>A61B 90/00</i> (2016.01)	6,455,931 B1	9/2002	Hamilton	
	<i>A61N 7/02</i> (2006.01)	6,518,168 B1	2/2003	Clem	
	<i>A61B 18/02</i> (2006.01)	6,567,158 B1	5/2003	Falcial	
	<i>A61B 18/22</i> (2006.01)	6,626,940 B2	9/2003	Crowley	
	<i>A61B 18/18</i> (2006.01)	6,641,860 B1	11/2003	Kaiserman	
		6,645,143 B2 *	11/2003	VanTassel	A61B 5/0031 600/300
(52)	U.S. Cl.	6,775,906 B1	8/2004	Silverbrook	
	CPC <i>A61B 34/25</i> (2016.02); <i>A61B 34/35</i> (2016.02); <i>A61B 90/30</i> (2016.02); <i>A61B 90/70</i> (2016.02); <i>A61N 1/0514</i> (2013.01); <i>A61N</i> <i>1/36007</i> (2013.01); <i>A61N 1/36135</i> (2013.01); <i>A61B 18/02</i> (2013.01); <i>A61B 18/22</i> (2013.01); <i>A61B 2018/00005</i> (2013.01); <i>A61B 2018/0022</i> (2013.01); <i>A61B 2018/00214</i> (2013.01); <i>A61B</i> <i>2018/00267</i> (2013.01); <i>A61B 2018/00273</i> (2013.01); <i>A61B 2018/00386</i> (2013.01); <i>A61B</i> <i>2018/00404</i> (2013.01); <i>A61B 2018/00434</i> (2013.01); <i>A61B 2018/00494</i> (2013.01); <i>A61B</i> <i>2018/00511</i> (2013.01); <i>A61B 2018/00517</i> (2013.01); <i>A61B 2018/00541</i> (2013.01); <i>A61B</i> <i>2018/00577</i> (2013.01); <i>A61B 2018/00642</i> (2013.01); <i>A61B 2018/00648</i> (2013.01); <i>A61B</i> <i>2018/00666</i> (2013.01); <i>A61B 2018/00672</i> (2013.01); <i>A61B 2018/00678</i> (2013.01); <i>A61B</i> <i>2018/00708</i> (2013.01); <i>A61B 2018/00744</i> (2013.01); <i>A61B 2018/00791</i> (2013.01); <i>A61B</i> <i>2018/00797</i> (2013.01); <i>A61B 2018/00815</i> (2013.01); <i>A61B 2018/00821</i> (2013.01); <i>A61B</i> <i>2018/00839</i> (2013.01); <i>A61B 2018/00863</i> (2013.01); <i>A61B 2018/00875</i> (2013.01); <i>A61B</i> <i>2018/0212</i> (2013.01); <i>A61B 2018/1861</i> (2013.01); <i>A61B 2034/252</i> (2016.02); <i>A61B</i> <i>2034/254</i> (2016.02); <i>A61B 2090/065</i> (2016.02); <i>A61N 7/02</i> (2013.01)	6,784,844 B1	8/2004	Boakes	
		6,805,809 B2	10/2004	Nuzzo	
		6,965,160 B2	11/2005	Cobbley	
		6,987,314 B1	1/2006	Yoshida	
		7,259,030 B2	8/2007	Daniels	
		7,265,298 B2	9/2007	Maghribi	
		7,302,751 B2	12/2007	Hamburgen	
		7,337,012 B2	2/2008	Maghribi	
		7,487,587 B2	2/2009	Vanfleteren	
		7,491,892 B2	2/2009	Wagner	
		7,521,292 B2	4/2009	Rogers	
		7,552,031 B2	6/2009	Vock	
		7,557,367 B2	7/2009	Rogers	
		7,618,260 B2	11/2009	Daniel	
		7,622,367 B1	11/2009	Nuzzo	
		7,727,228 B2	6/2010	Abboud	
		7,732,012 B2	6/2010	Hongu	
		7,739,791 B2	6/2010	Brandenburg	
		7,759,167 B2	7/2010	Vanfleteren	
		7,815,095 B2	10/2010	Fujisawa	
		7,909,971 B2	3/2011	Nuzzo	
		7,960,246 B2	6/2011	Flamand	
		7,982,296 B2	7/2011	Nuzzo	
		8,008,575 B2	8/2011	De Ceuster	
		8,097,926 B2	1/2012	De Graff	
		8,198,621 B2	6/2012	Rogers	
		8,207,473 B2	6/2012	Axisa	
		8,217,381 B2	7/2012	Rogers	
		8,252,191 B2	8/2012	Heejoon	
		8,367,035 B2	2/2013	Rogers	
		8,372,726 B2	2/2013	De Graff	
		8,389,862 B2	3/2013	Arora	
		8,394,706 B2	3/2013	Nuzzo	
		8,431,828 B2	4/2013	Vanfleteren	
		8,440,546 B2	5/2013	Nuzzo	
		8,536,667 B2	9/2013	De Graff	
		8,552,299 B2	10/2013	Rogers	
		8,618,656 B2	12/2013	Oh	
		8,664,699 B2	3/2014	Nuzzo	
		8,679,888 B2	3/2014	Rogers	
		8,729,524 B2	5/2014	Rogers	
		8,754,396 B2	6/2014	Rogers	
		8,865,489 B2	10/2014	Rogers	
		8,886,334 B2	11/2014	Ghaffari	
		8,905,772 B2 *	12/2014	Rogers	H01L 21/4867 257/642

(56) **References Cited**

U.S. PATENT DOCUMENTS

3,838,240 A	9/1974	Schelhorn
4,058,418 A	11/1977	Lindmayer
4,278,474 A	7/1981	Blakeslee
4,304,235 A	12/1981	Kaufman
4,416,288 A	11/1983	Freeman
4,658,153 A	4/1987	Brosh
5,272,375 A	12/1993	Belopolsky
5,306,917 A	4/1994	Black
5,326,521 A	7/1994	East
5,331,966 A	7/1994	Bennett
5,360,987 A	11/1994	Shibib

(56)		References Cited			
		U.S. PATENT DOCUMENTS			
9,105,555	B2	8/2015	Rogers	2007/0254468	A1 11/2007 Burdick, Jr.
9,105,782	B2	8/2015	Rogers	2007/0270672	A1 11/2007 Hayter
9,119,533	B2	9/2015	Ghaffari	2008/0036097	A1 2/2008 Ito
9,123,614	B2	9/2015	Graff	2008/0046080	A1 2/2008 Vanden Bulcke
9,159,635	B2	10/2015	Elolampi	2008/0074383	A1 3/2008 Dean
9,168,094	B2	10/2015	Lee	2008/0096620	A1 4/2008 Lee
9,171,794	B2	10/2015	Rafferty	2008/0139894	A1 6/2008 Szydlo-Moore
9,186,060	B2	11/2015	De Graff	2008/0157235	A1 7/2008 Rogers
9,226,402	B2	12/2015	Hsu	2008/0188912	A1 8/2008 Stone
9,247,637	B2	1/2016	Hsu	2008/0193749	A1 8/2008 Thompson
9,289,132	B2	3/2016	Ghaffari	2008/0204021	A1 8/2008 Leussler
9,295,842	B2	3/2016	Ghaffari	2008/0211087	A1 9/2008 Mueller-Hipper
9,324,733	B2	4/2016	Rogers	2008/0237840	A1 10/2008 Alcoe
2001/0012918	A1	8/2001	Swanson	2008/0259576	A1 10/2008 Johnson
2001/0021867	A1	9/2001	Kordis	2008/0287167	A1 11/2008 Caine
2002/0026127	A1	2/2002	Balbierz	2008/0313552	A1 12/2008 Buehler
2002/0082515	A1	6/2002	Campbell	2009/0000377	A1 1/2009 Shipps
2002/0094701	A1	7/2002	Biegelsen	2009/0001550	A1 1/2009 Li et al.
2002/0113739	A1	8/2002	Howard	2009/0015560	A1 1/2009 Robinson
2002/0128700	A1	9/2002	Cross, Jr.	2009/0017884	A1 1/2009 Rotschild
2002/0145467	A1	10/2002	Minch	2009/0024016	A1* 1/2009 Zhang A61B 5/01 600/381
2002/0151934	A1	10/2002	Levine	2009/0048556	A1 2/2009 Durand
2002/0158330	A1	10/2002	Moon	2009/0088750	A1 4/2009 Hushka
2003/0017848	A1	1/2003	Engstrom	2009/0107704	A1 4/2009 Vanfleteren
2003/0045025	A1	3/2003	Coyle	2009/0154736	A1 6/2009 Lee
2003/0097165	A1	5/2003	Kruelevitch	2009/0184254	A1 7/2009 Miura
2003/0120271	A1	6/2003	Burnside	2009/0204168	A1 8/2009 Kallmeyer
2003/0162507	A1	8/2003	Vatt	2009/0215385	A1 8/2009 Waters
2003/0214408	A1	11/2003	Grajales	2009/0225751	A1 9/2009 Koenck
2003/0236455	A1	12/2003	Swanson	2009/0261828	A1 10/2009 Nordmeyer-Massner
2004/0006264	A1	1/2004	Mojarradi	2009/0273909	A1 11/2009 Shin
2004/0085469	A1	5/2004	Johnson	2009/0283891	A1 11/2009 Dekker
2004/0092806	A1	5/2004	Sagon	2009/0291508	A1 11/2009 Babu
2004/0106334	A1	6/2004	Suzuki	2009/0294803	A1 12/2009 Nuzzo
2004/0135094	A1	7/2004	Niigaki	2009/0308455	A1 12/2009 Kirscht
2004/0138558	A1	7/2004	Dunki-Jacobs	2009/0322480	A1 12/2009 Benedict
2004/0149921	A1	8/2004	Smyk	2010/0002402	A1 1/2010 Rogers
2004/0178466	A1	9/2004	Merrill	2010/0059863	A1 3/2010 Rogers
2004/0192082	A1	9/2004	Wagner	2010/0072577	A1 3/2010 Nuzzo
2004/0201134	A1	10/2004	Kawai	2010/0073669	A1 3/2010 Colvin
2004/0203486	A1	10/2004	Shepherd	2010/0087782	A1 4/2010 Ghaffari
2004/0221370	A1	11/2004	Hannula	2010/0090781	A1 4/2010 Yamamoto
2004/0243204	A1	12/2004	Maghribi	2010/0090824	A1 4/2010 Rowell
2005/0021103	A1	1/2005	DiLorenzo	2010/0116526	A1 5/2010 Arora
2005/0029680	A1	2/2005	Jung	2010/0117660	A1 5/2010 Douglas
2005/0067293	A1	3/2005	Naito	2010/0178722	A1 7/2010 De Graff
2005/0070778	A1	3/2005	Lackey	2010/0245011	A1 9/2010 Chatzopoulos
2005/0096513	A1	5/2005	Ozguz	2010/0271191	A1 10/2010 De Graff
2005/0107716	A1	5/2005	Eaton	2010/0298895	A1 11/2010 Ghaffari
2005/0113744	A1	5/2005	Donoghue	2010/0317132	A1 12/2010 Rogers
2005/0139683	A1	6/2005	Yi	2010/0321161	A1 12/2010 Isabell
2005/0171524	A1	8/2005	Stern	2010/0327387	A1 12/2010 Kasai
2005/0203366	A1	9/2005	Donoghue	2011/0011179	A1 1/2011 Gustafsson
2005/0248312	A1	11/2005	Cao	2011/0034912	A1 2/2011 De Graff
2005/0285262	A1	12/2005	Knapp	2011/0051384	A1 3/2011 Kriechbaum
2006/0000273	A1	1/2006	Keppner	2011/0054583	A1 3/2011 Litt
2006/0003709	A1	1/2006	Wood	2011/0101789	A1 5/2011 Salter
2006/0038182	A1	2/2006	Rogers	2011/0121822	A1 5/2011 Parsche
2006/0068576	A1	3/2006	Burdick, Jr.	2011/0140897	A1 6/2011 Purks
2006/0071349	A1	4/2006	Tokushige	2011/0175735	A1 7/2011 Forster
2006/0084394	A1	4/2006	Engstrom	2011/0184320	A1 7/2011 Shipps
2006/0106321	A1	5/2006	Lewinsky	2011/0215931	A1 9/2011 Callsen
2006/0128346	A1	6/2006	Yasui	2011/0218756	A1 9/2011 Callsen
2006/0154398	A1	7/2006	Qing	2011/0218757	A1 9/2011 Callsen
2006/0160560	A1	7/2006	Josenhans	2011/0220890	A1 9/2011 Nuzzo
2006/0248946	A1	11/2006	Howell	2011/0277813	A1 11/2011 Rogers
2006/0257945	A1	11/2006	Masters	2011/0284268	A1 11/2011 Palaniswamy
2006/0264767	A1	11/2006	Shennib	2011/0306851	A1* 12/2011 Wang A61B 5/4893 600/301
2006/0270135	A1	11/2006	Chrysler	2012/0016258	A1 1/2012 Webster
2006/0286785	A1	12/2006	Rogers	2012/0051005	A1 3/2012 Vanfleteren
2007/0027514	A1	2/2007	Gerber	2012/0052268	A1 3/2012 Axisa
2007/0031283	A1	2/2007	Davis	2012/0065937	A1 3/2012 De Graff
2007/0108389	A1	5/2007	Makela	2012/0074546	A1 3/2012 Chong
2007/0113399	A1	5/2007	Kumar	2012/0083099	A1 4/2012 Nuzzo
2007/0123756	A1	5/2007	Kitajima	2012/0087216	A1 4/2012 Keung
				2012/0091594	A1 4/2012 Landesberger
				2012/0092178	A1 4/2012 Callsen

(56)

References Cited

U.S. PATENT DOCUMENTS

2012/0092222 A1 4/2012 Kato
 2012/0101413 A1 4/2012 Beetel
 2012/0101538 A1 4/2012 Ballakur
 2012/0108012 A1 5/2012 Yasuda
 2012/0126418 A1 5/2012 Feng
 2012/0136350 A1* 5/2012 Goshgarian A61B 18/1492
 606/41

2012/0143293 A1 6/2012 Mauch
 2012/0157804 A1 6/2012 Rogers
 2012/0172697 A1 7/2012 Urman
 2012/0178367 A1 7/2012 Matsumoto
 2012/0226130 A1 9/2012 De Graff
 2012/0244848 A1 9/2012 Ghaffari
 2012/0256308 A1 10/2012 Helin
 2012/0316455 A1 12/2012 Rahman
 2012/0320581 A1 12/2012 Rogers
 2012/0327608 A1 12/2012 Rogers
 2013/0036928 A1 2/2013 Rogers
 2013/0041235 A1 2/2013 Rogers
 2013/0099358 A1 4/2013 Elolampi
 2013/0100618 A1 4/2013 Rogers
 2013/0118255 A1 5/2013 Callsen
 2013/0150693 A1 6/2013 D'angelo
 2013/0185003 A1 7/2013 Carbeck
 2013/0192356 A1 8/2013 De Graff
 2013/0200268 A1 8/2013 Rafferty
 2013/0211761 A1 8/2013 Brandsma
 2013/0214300 A1 8/2013 Lerman
 2013/0215467 A1 8/2013 Fein
 2013/0225965 A1 8/2013 Ghaffari
 2013/0237150 A1 9/2013 Royston
 2013/0245388 A1 9/2013 Rafferty
 2013/0274562 A1 10/2013 Ghaffari
 2013/0313713 A1 11/2013 Arora
 2013/0316442 A1 11/2013 Meurville
 2013/0316487 A1 11/2013 De Graff
 2013/0316645 A1 11/2013 Li
 2013/0320503 A1 12/2013 Nuzzo
 2013/0321373 A1 12/2013 Yoshizumi
 2013/0328219 A1 12/2013 Chau
 2014/0001058 A1 1/2014 Ghaffari
 2014/0012160 A1 1/2014 Ghaffari
 2014/0012242 A1 1/2014 Lee
 2014/0022746 A1 1/2014 Hsu
 2014/0039290 A1 2/2014 De Graff
 2014/0097944 A1 4/2014 Fastert
 2014/0110859 A1 4/2014 Rafferty
 2014/0114305 A1 4/2014 Zarins
 2014/0140020 A1 5/2014 Rogers
 2014/0188426 A1 7/2014 Fastert
 2014/0191236 A1 7/2014 Nuzzo
 2014/0216524 A1 8/2014 Rogers
 2014/0240932 A1 8/2014 Hsu
 2014/0249520 A1 9/2014 Ghaffari
 2014/0303452 A1 10/2014 Ghaffari
 2014/0336476 A1* 11/2014 Li A61B 5/026
 600/301
 2014/0340857 A1 11/2014 Hsu
 2014/0374872 A1 12/2014 Rogers
 2014/0375465 A1 12/2014 Fenuccio
 2015/0001462 A1 1/2015 Rogers
 2015/0019135 A1 1/2015 Kacyvenski
 2015/0035680 A1 2/2015 Li
 2015/0069617 A1 3/2015 Arora
 2015/0099976 A1 4/2015 Ghaffari
 2015/0100135 A1 4/2015 Ives
 2015/0194817 A1 7/2015 Lee
 2015/0237711 A1 8/2015 Rogers
 2015/0241288 A1 8/2015 Keen
 2015/0260713 A1 9/2015 Ghaffari
 2015/0272652 A1 10/2015 Ghaffari
 2015/0286913 A1 10/2015 Fastert
 2015/0320472 A1 11/2015 Ghaffari
 2015/0335254 A1 11/2015 Fastert et al.
 2015/0342036 A1 11/2015 Elolampi et al.

2016/0027834 A1 1/2016 Graff
 2016/0045162 A1 2/2016 De Graff
 2016/0081192 A1 3/2016 Hsu
 2016/0086909 A1 3/2016 Garlock
 2016/0095652 A1 4/2016 Lee
 2016/0099214 A1 4/2016 Dalal
 2016/0099227 A1 4/2016 Dalal
 2016/0111353 A1 4/2016 Rafferty

FOREIGN PATENT DOCUMENTS

EP 0779059 A1 6/1997
 EP 1808124 A2 7/2007
 EP 2259062 A2 12/2010
 JP 05-087511 A 4/1993
 JP H05307045 A 11/1993
 JP 2003297974 10/2003
 JP 2006017723 A 1/2006
 JP 2008515544 A 5/2008
 JP 2009-170173 A 7/2009
 WO WO 99/38211 A2 7/1999
 WO WO 03/021679 A2 3/2003
 WO WO 2005/033787 4/2005
 WO WO 2005/122285 A2 12/2005
 WO WO 2006/041881 A2 4/2006
 WO WO 2007/003019 A2 1/2007
 WO WO 2007/024983 A2 3/2007
 WO WO 2007/116344 A1 10/2007
 WO WO 2007/136726 A2 11/2007
 WO WO 2008/030960 A2 3/2008
 WO WO 2009/111641 A1 9/2009
 WO WO 2009/114689 A1 9/2009
 WO WO 2010/036807 A1 4/2010
 WO WO 2010/042653 A1 4/2010
 WO WO 2010/042957 A2 4/2010
 WO WO 2010/046883 A1 4/2010
 WO WO 2010/056857 A2 5/2010
 WO WO 2010/081137 A2 7/2010
 WO WO 2010/082993 A2 7/2010
 WO WO 2010/102310 A2 9/2010
 WO WO 2010/132552 A1 11/2010
 WO WO 2011/002931 1/2011
 WO WO 2011/003181 A1 1/2011
 WO WO 2011/041727 A1 4/2011
 WO WO 2011/084450 A1 7/2011
 WO WO 2011/084709 A2 7/2011
 WO WO 2011/127331 A2 10/2011
 WO WO 2012/097163 7/2012
 WO WO 2012/125494 A2 9/2012
 WO WO 2012/158709 11/2012
 WO WO 2012/166686 A2 12/2012
 WO WO 2012/167096 12/2012
 WO WO 2013/010113 1/2013
 WO WO 2013/010171 A1 1/2013
 WO WO 2013/022853 A1 2/2013
 WO WO 2013/033724 A1 3/2013
 WO WO 2013/034987 A3 3/2013
 WO WO 2013/049716 A1 4/2013
 WO WO 2013/052919 A2 4/2013
 WO WO 2013/170032 A2 11/2013
 WO WO 2014/007871 A1 1/2014
 WO WO 2014/058473 A1 4/2014
 WO WO 2014/059032 A1 4/2014
 WO WO 2014/106041 A1 7/2014
 WO WO 2014/110176 A1 7/2014
 WO WO 2014/130928 A2 8/2014
 WO WO 2014/130931 A1 8/2014
 WO WO 2014/186467 A2 11/2014
 WO WO 2014/197443 A1 12/2014
 WO WO 2014/205434 A2 12/2014
 WO WO 2015/021039 A1 2/2015
 WO WO 2015/054312 A1 4/2015
 WO WO 2015/077559 A1 5/2015
 WO WO 2015/080991 A1 6/2015
 WO WO 2015/102951 A2 7/2015
 WO WO 2015/103483 A1 7/2015
 WO WO 2015/103580 A2 7/2015
 WO WO 2015/127458 A1 8/2015
 WO WO 2015/134588 A1 9/2015

(56) **References Cited**

FOREIGN PATENT DOCUMENTS

WO WO 2015/138712 A1 9/2015
 WO WO 2016/048888 A1 3/2016
 WO WO 2016/054512 A1 4/2016
 WO WO 2016/057318 A1 4/2016

OTHER PUBLICATIONS

- Demura et al., "Immobilization of Glucose Oxidase with *Bombyx mori* Silk Fibroin by Only Stretching Treatment and its Application to Glucose Sensor," *Biotechnology and Bioengineering*, vol. 33, 598-603 (6 pages) (1989).
- Ellerbee et al., "Quantifying Colorimetric Assays in Paper-Based Microfluidic Devices by Measuring the Transmission of Light through Paper," *Analytical Chemistry*, vol. 81, No. 20 8447-8452, (6 pages) (Oct. 15, 2009).
- Halsted, "Ligature and Suture Material," *Journal of the American Medical Association*, vol. LX, No. 15, 1119-1126, (8 pages) (Apr. 12, 1913).
- Kim et al., "Complementary Metal Oxide Silicon Integrated Circuits Incorporating Monolithically Integrated Stretchable Wavy Interconnects," *Applied Physics Letters*, vol. 93, 044102-044102.3 (3 pages) (Jul. 31, 2008).
- Kim et al., "Dissolvable Films of Silk Fibroin for Ultrathin Conformal Bio-Integrated Electronics," *Nature*, 1-8 (8 pages) (Apr. 18, 2010).
- Kim et al., "Materials and Noncoplanar Mesh Designs for Integrated Circuits with Linear Elastic Responses to Extreme Mechanical Deformations," *PNAS*, vol. 105, No. 48, 18675-18680 (6 pages) (Dec. 2, 2008).
- Kim et al., "Stretchable and Foldable Silicon Integrated Circuits," *Science*, vol. 320, 507-511 (5 pages) (Apr. 25, 2008).
- Kim et al., "Electrowetting on Paper for Electronic Paper Display," *ACS Applied Materials & Interfaces*, vol. 2, No. 11, (3318-3323) (6 pages) (Nov. 24, 2010).
- Ko et al., "A Hemispherical Electronic Eye Camera Based on Compressible Silicon Optoelectronics," *Nature*, vol. 454, 748-753 (6 pages) (Aug. 7, 2008).
- Lawrence et al., "Bioactive Silk Protein Biomaterial Systems for Optical Devices," *Biomacromolecules*, vol. 9, 1214-1220 (7 pages) (Nov. 4, 2008).
- Meitl et al., "Transfer Printing by Kinetic Control of Adhesion to an Elastomeric Stamp," *Nature*, vol. 5, 33-38 (6 pages) (Jan. 2006).
- Omenetto et al., "A New Route for Silk," *Nature Photonics*, vol. 2, 641-643 (3 pages) (Nov. 2008).
- Omenetto et al., "New Opportunities for an Ancient Material," *Science*, vol. 329, 528-531 (5 pages) (Jul. 30, 2010).
- Siegel et al., "Foldable Printed Circuit Boards on Paper Substrates," *Advanced Functional Materials*, vol. 20, No. 1, 28-35, (8 pages) (Jan. 8, 2010).
- Tsukada et al., "Structural Changes of Silk Fibroin Membranes Induced by Immersion in Methanol Aqueous Solutions," *Journal of Polymer Science*, vol. 32, 961-968 (8 pages) (1994).
- Wang et al., "Controlled Release From Multilayer Silk Biomaterial Coatings to Modulate Vascular Cell Responses" *Biomaterials*, 29, 894-903 (10 pages) (Nov. 28, 2008).
- Wikipedia, "Ball bonding" article [online]. Cited in PCT/US2015/051210 search report dated Mar. 1, 2016 with the following information "Jun. 15, 2011 [retrieved on Nov. 15, 2015]. Retrieved 12-18, 29 from the Internet: <URL: https://web.archive.org/web/20110615221003/http://en.wikipedia.org/wiki/Ball_bonding>., entire document, especially para 1, 4, 5, 6," 2 pages, last page says ("last modified on May 11, 2011").
- International Search Report, PCT/US2013/32714, 2 pages, dated Jun. 5, 2013.
- International Written Opinion, PCT/US2013/32714, 11 pages, dated Jun. 5, 2013.
- International Search Report, PCT/US2014/071516, 4 pages, dated Jun. 4, 2015.
- International Written Opinion, PCT/US2014/071516, 9 pages, dated Jun. 4, 2015.
- Ahn, H. et al., "Additive Soft Lithographic Patterning of Submicron and Nanometer-Scale Large Area Resists on Electronic Materials," *Nano Letters*, 5, 2533-2537 (2005).
- Baca, A.J. et al., "Compact monocrystalline silicon solar modules with high voltage outputs and mechanically flexible designs," *Energy Environ. Sci.*, 2010, 3, 208-211.
- Baca, A.J. et al., "Printable single-crystal silicon micro/nanoscale ribbons, platelets and bars generated from bulk wafers," *Adv. Func. Mater.* 17, 3051-3062 (2007).
- Bagnall, D.M. et al. "Photovoltaic Technologies," *Energy Policy*, 2008, 36, 4390.
- Bergmann, R.B. "Crystalline Si thin-film solar cells: a review," *Appl. Phys. A* 69, 187-194 (1999).
- Biancardo, M. et al., "Characterization of microspherical semi-transparent solar cells and modules," *Sol. Energy* 81, 711-716 (2007).
- Bossert, R.H. et al., "Thin Film Solar Cells: Technology Evaluation and Perspectives," *ECN*, May 2000.
- Brendel, R. "Review of layer transfer processes for crystalline thin-film silicon solar cells," *Jpn. J. Appl. Phys.* 40, 4431-4439 (2001).
- Brendel, R. et al., "Ultrathin crystalline silicon solar cells on glass substrates," *Appl. Phys. Lett.* 70, 390-392 (1997).
- Burgelman, M. et al. "Modeling Thin-Film PV Devices," *Progress in Photovoltaics* 12, 143-153 (2004).
- Cahill, D.G. et al., "Thermal conductivity of epitaxial layers of dilute SiGe alloys," *Phys. Rev. B*, 71:23, 235202-1-4 (2005).
- Campbell, P. et al., "Light Trapping Properties of Pyramidally Textured Surfaces," *J. Appl. Phys.* 62, 243-249 (1987).
- Clugston, D.A. et al., "Modelling Free-Carrier Absorption in Solar Cells," *Progress in Photovoltaics* 5, 229-236 (1997).
- Clugston, D.A. et al., "PC1D version 5: 32-bit solar cell modeling on personal computers," *Photovoltaic Specialist Conference, 1997, Conference Record of the Twenty-Sixth IEEE*, 207-210.
- Ebong, A. et al., "Rapid Thermal Processing of High Efficiency N-Type Silicon Solar Cells With Al back Junction," 14th World Conference on Photovoltaic Energy Conversion, Hawaii, USA; May 7-12, 2006.
- Feng, N.-N. et al., "Design of Highly Efficient Light-Trapping Structures for Thin-Film Crystalline Silicon Solar Cells," *IEEE Trans. Elect. Dev.* 54, 1926-1933 (2007).
- First Office Action dated Mar. 5, 2013 from Chinese Patent Application No. 200980116128.1—includes English translation.
- Green, M.A. "Crystalline and thin-film silicon solar cells: state of the art and future potential," *Sol. Energy* 74, 181-192 (2003).
- Heine, C. et al., "Submicrometer Gratings for Solar-Energy Applications," *Appl. Opt.* 34, 2476-2482 (1995).
- International Search Report and Written Opinion, Corresponding to International Application No. PCT/US12/59131, dated Apr. 8, 2013.
- J. Wang et al., "Binding and Diffusion of a Si Adatom Around the Type-A Step on Si(01) c4x2," *Appl. Phys. Lett.*, 66:15, 1954 (1995).
- J. Yoon et al., J. Yoon et al., "Arrays of Monocrystalline Silicon Solar Micro-cells for Modules with Ultra-thin, Mechanically Flexible, Semi-transparent and Micro-optic Concentrator Designs," *Materials Research Society (MRS) Symposium P: Photovoltaic Materials and Manufacturing Issues, Fall Meeting, Dec. 3, 2008—Abstract provided.*
- J. Yoon et al., "Ultrathin silicon solar microcells for semitransparent, mechanically flexible and microconcentrator module designs," *Nat. Mater.*, 2008, 7, 907.
- Jeon, S. et al., "Fabricating three dimensional nanostructures using two photon lithography in a single exposure step," *Optics Express*, 14:6, 2300-23208 (2006).
- Jeon, S. et al., "Optically fabricated three dimensional nanofluidic mixers for microfluidic systems," *Nano Letters*, 5:7, 1351-1356 (2005).
- K. J. Weber et al., "A Novel Silicon Texturization Method Based on Etching Through a Silicon Nitride Mask," *Progress in Photovoltaics: Research and Applications* 13, 691-695 (2005).

(56)

References Cited

OTHER PUBLICATIONS

- Kazmerski, L.L. et al., "Solar photovoltaics R&D at the tipping point: A 2005 technology overview." *J. Elect. Spec. Rel. Phenom.* 150, 105-135 (2006).
- Kerschaver, E. V. et al., "Back-contact Solar Cells: A Review," *Prog. Photovolt.* 14, 107-123 (2006).
- Kunnavaikkam, M.V. et al., "Low-cost, low-loss microlens arrays fabricated by soft-lithography replication process," *Appl. Phys. Lett.* 82, 1152-1154 (2003).
- Lee, H.H. et al., "Fabrication of Large Area Stamps, Moulds, and Conformable Photomasks for Soft Lithography," *Journal of Nanoengineering and Nanosystems* 218, 105 (2005).
- Lee, K.J. et al., "Bendable GaN High Electron Mobility Transistors on Plastic Substrates," *Journal of Applied Physics* 100, 124507 (2006).
- Lei, C. et al., "Grain Boundary Compositions in Cu(InGa)Se₂," *J. Appl. Phys.*, 101:2, 24909-1-7 (2007).
- Lei, C. et al., "Void formation and surface energies in Cu(InGa)Se₂," *J. Appl. Phys.* 100:7, 073518 (2006).
- Liao, D. et al., "Cu depletion at the CuInSe₂ Surface," *Appl. Phys. Lett.*, 82:17, 2829-2831 (2003).
- Liu, Z.X. et al., "A concentrator module of spherical Si solar cell," *Sol. Energy Mater. Sol. Cells* 91, 1805-1810 (2007).
- Love, J.C. et al., "Self-Assembled Monolayers of Thiolates on metals as a Form of Nanotechnology," *Chem. Rev.*, 105, 1103-1169 (2005).
- M.E. Stewart et al., "Quantitative Multispectral Miosensing and 1-D Imaging Using Quasi-3D Plasmonic Crystals," *Proc. Nat. Acad. Sci.*, 103, 17143-17148 (2006).
- Mack, S. et al., "Mechanically flexible thin-film transistors that use ultrathin ribbons of silicon derived from bulk wafers," *Appl. Phys. Lett.*, 88, 213101 (2006).
- Malyarchuk, V. et al., "High performance plasmonic crystal sensor formed by soft nanoimprint lithography," *Optics Express*, 13:15, 5669-5675 (2005).
- Mercaldo, L.V. et al., Thin film silicon photovoltaics: Architectural perspectives and technological issues, *App. Energy*, 2009, 86, 1836.
- Minemoto, T. et al., "Fabrication of spherical silicon crystals by dropping method and their application to solar cells," *Jpn. J. Appl. Phys.* 46, 4016-4020 (2007).
- Nelson, B. et al., "Amorphous and Thin-Film Silicon," *NCPV and Solar Program Review*, NREL/CD-520-33586, 583-585, 2003.
- Nelson, B. et al., "Project Summary of the NREL Amorphous Silicon Team," *NCPV and Solar Program Review*, NREL/CD-520-33586, 825-828, 2003.
- Niggemann, M. et al., Realization of Ultrahigh Photovoltaics with Organic Photovoltaic Nanomaterials, *Adv. Mater.* 2008, 20, 4055.
- Notice of Allowance corresponding to Korean Patent Application No. 10-20102-7010094, dated Feb. 25, 2013—includes English translation.
- Notice of Allowance, U.S. Appl. No. 12/398,811 dated May 24, 2013.
- Notice of Final Rejection for Japanese Patent Application No. 2006-16159, dated Apr. 16, 2013.
- Notice of Preliminary Rejection, corresponding to Korean Patent Application No. 10-2007-7000216, dated Feb. 21, 2013—includes English translation.
- Notice of Preliminary Rejection, corresponding to Korean Patent Application No. 10-2012-7030789, dated Feb. 25, 2013—includes English translation.
- Office Action, Corresponding to Chinese Patent Application No. 2009801161280.1, dated Mar. 5, 2013.
- Office Action, Corresponding to U.S. Appl. No. 13/441,618, dated May 23, 2013.
- Office Action, Corresponding to U.S. Appl. No. 13/120,486, dated Apr. 12, 2013.
- Orega, P. et al., "High Voltage Photovoltaic Mini-modules," *Prog. Photovolt.: Res. Appl.*, 2008, 16, 369.
- Pizzini, S., "Bulk solar grade silicon: how chemistry and physics play to get a benevolent microstructured material," *Appl. Phys. A: Mater. Sci. Process.*, 2009, 96, 171.
- R. Rockett et al., "Prediction of dopant ionization energies in silicon: The importance of strain," *Physical Review B*, 6823:23, 3208 (2003).
- Rockett, A. "The effect of Na in polycrystalline and single crystal Culni_xGaxSe₂," *Thin Solid Films*, 480-1, 2-7 (2005).
- Rockett, A. et al., "A Monte Carlo simulation of the growth of si(001)2x1: adatom/SA step interactions and growth mechanisms," *Surf. Sci.*, 312, 201 (1994).
- Rockett, A. et al., "Near-surface Defect Distributions in Cu(In,Ga)Se₂" *Thin Solid Films*, 431-2, 301-306 (2003).
- Roedern, B. "Status of Amorphous and Crystalline Thin-Film Silicon Solar Cell Activities," *NCPV and Solar Program Review*, NREL/CD-520-33586, 552-555, 2003.
- Ruby, D.S. et al., "Rie-texturing of multicrystalline silicon solar cells," *Solar Energy Materials & Solar Cells* 74, 133-137 (2002).
- Sha, A. et al., "Recent progress on microcrystalline solar cells," *Photovoltaic Specialists Conference, Conference Record of the Twenty-Sixth IEEE*, 569-574 (1997).
- Sinton, R.A. et al., "27.5-Percent Silicon Concentrator Solar-Cells," *IEEE Elect. Dev. Lett.* 7, 567-569 (1986).
- Sobajima et al., "Microstructures of high-growth-rate (up to 8.3 nm/s) microcrystalline silicon photovoltaic layers and their influence on the photovoltaic performance of thin-film solar cells," *J. Non-Cryst. Solids*, 2008, 354, 2407.
- Sun, Y. et al., "Gigahertz Operation in Mechanically Flexible Transistors on Plastic Substrates," *Applied Physics Letters* 88, 183509 (2006).
- Sun, Y. et al., "Printed Arrays of Aligned GaAs Wires for Flexible Transistors, Diodes and Circuits on Plastic Substrates," *Small* 2(11), 1330-1334 (2006).
- Sun, Y. et al., "Top Down Fabrication of Semiconductor Nanowires With Alternating Structures Along Their Transverse and Longitudinal Axes," *Small* 1(11), 1052-1057 (2005).
- Taguchi, M. et al., "HIT TM cells—High efficiency crystalline Si cells with novel structure," *Prog. Photovolt.* 8, 503-513 (2000).
- Verlinden, P.J. et al., "Silver (R) solar cells: A new thin-crystalline silicon photovoltaic technology," *Sol. Energy Mater. Sol. Cells* 90, 3422-3430 (2006).
- Weber, K.J. et al., "A Novel-Low Cost, High Efficiency Micromachined Silicon Solar Cell," *IEEE Electron Device Letters*, vol. 25, No. 1, 37-39 (2004).
- Wenham, S.R. et al., "Buried contact silicon solar cells," *Solar Energy Materials and Solar Cells*, 34, 101-110 (1994).
- Yamamoto, K. et al., "Thin-film poly-Si solar cells on glass substrate fabricated at low temperature," *Applied Physics A: Materials Science & Processing* 69, 179-185 (1999).
- Zhao et al., "24.5% efficiency silicon PERT cells on MCZ substrates and 24.7% efficiency PERL cells on FZ substrates," *Prog. Photovolt.* 7, 471-474 (1999).

* cited by examiner

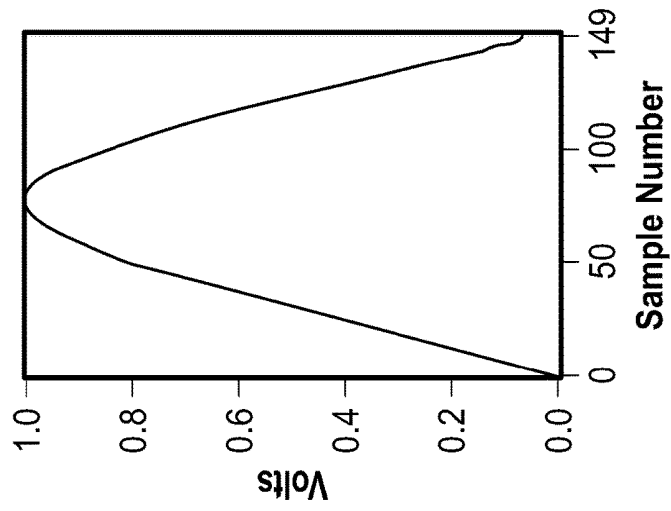
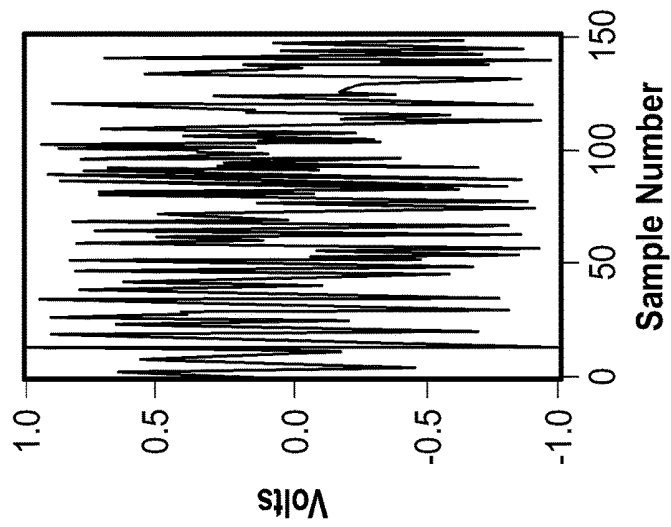

Fig. 1B



Amplitude x Duration
2.0 V x 150 ms=300 Vxms

Fig. 1A

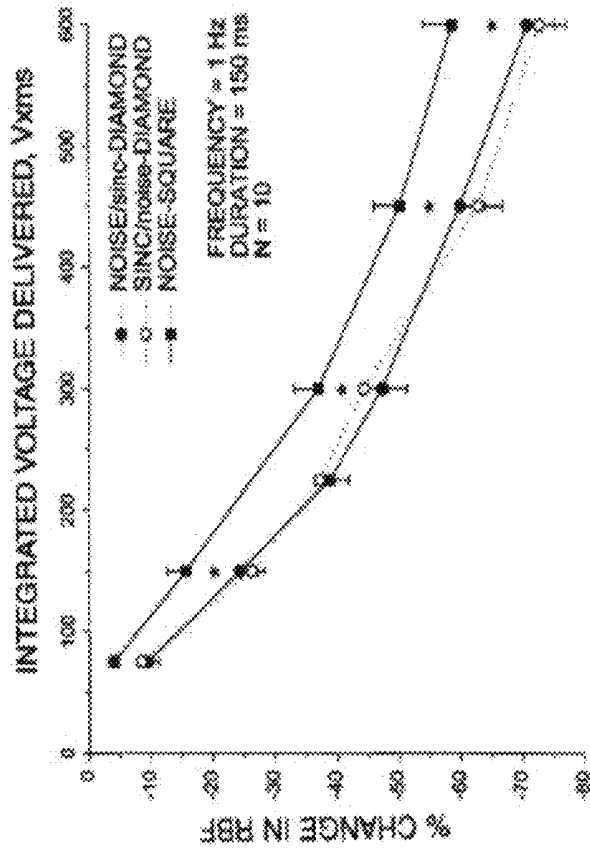
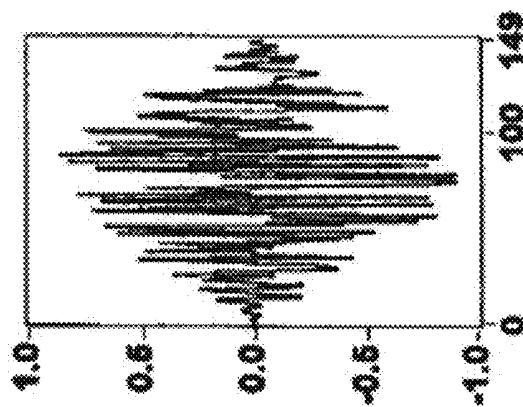

FIG. 2

FIG. 1C



0.5 (amplitude x duration)
0.5 (2.0 V x 150 ms)=150 V xms

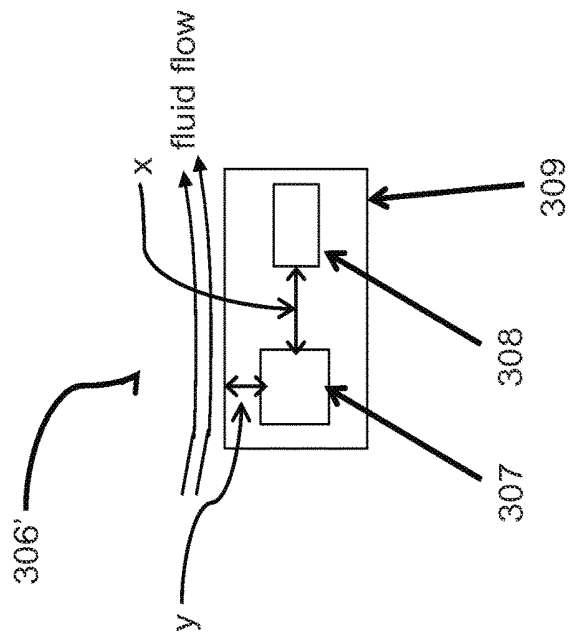

FIG. 3B

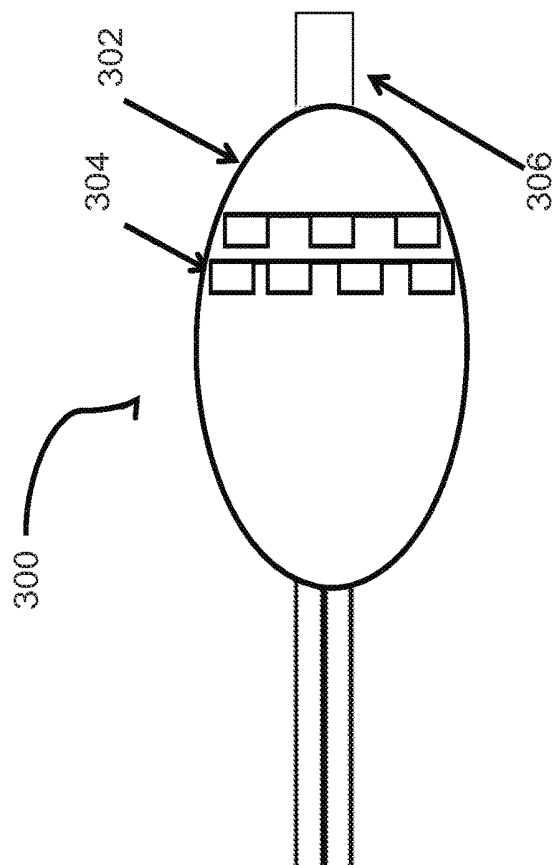

FIG. 3A

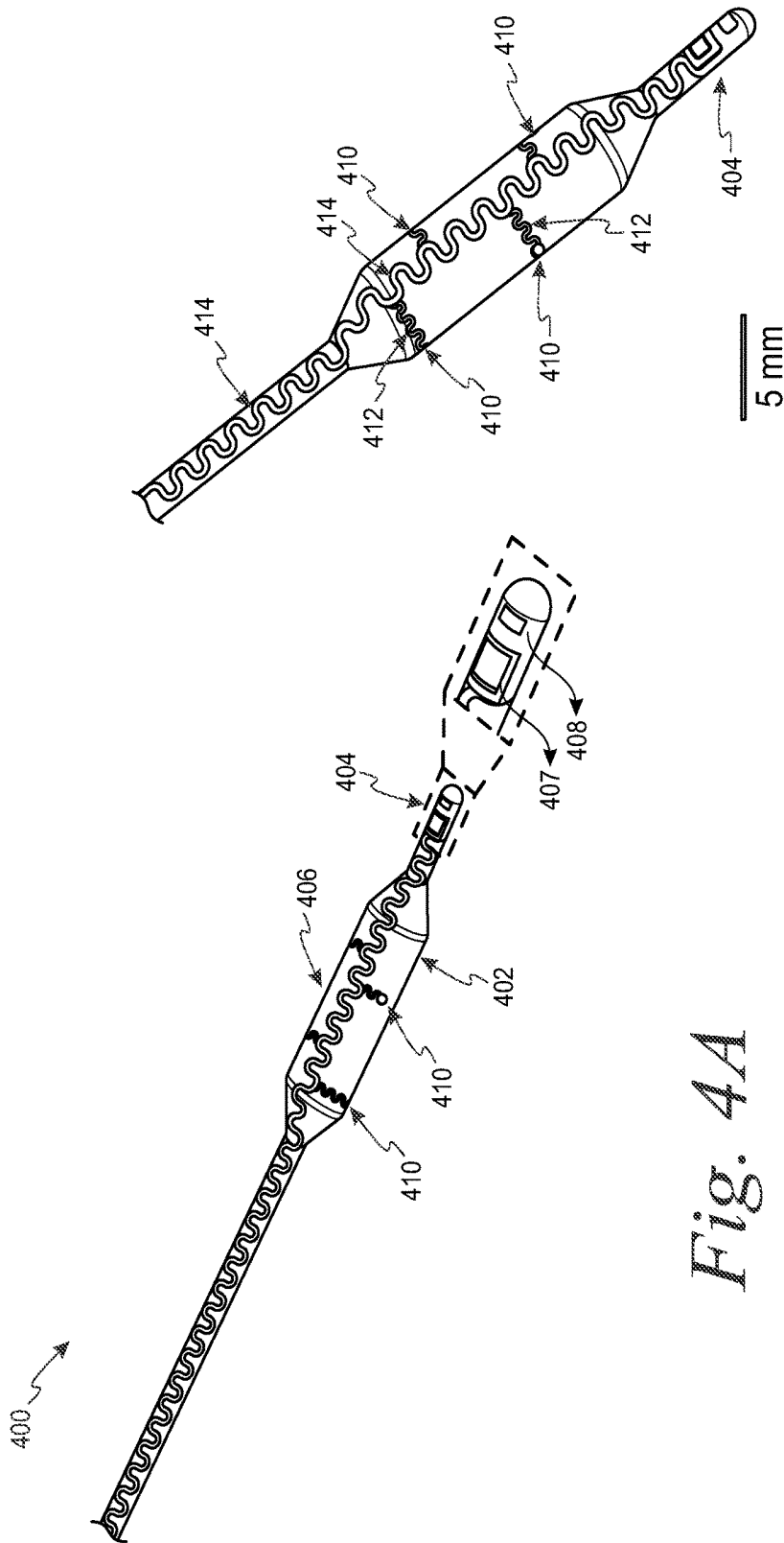

Fig. 4A

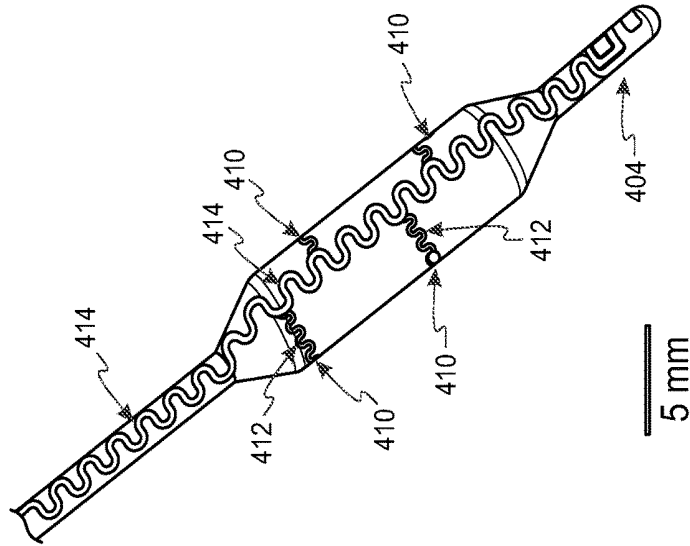

Fig. 4B

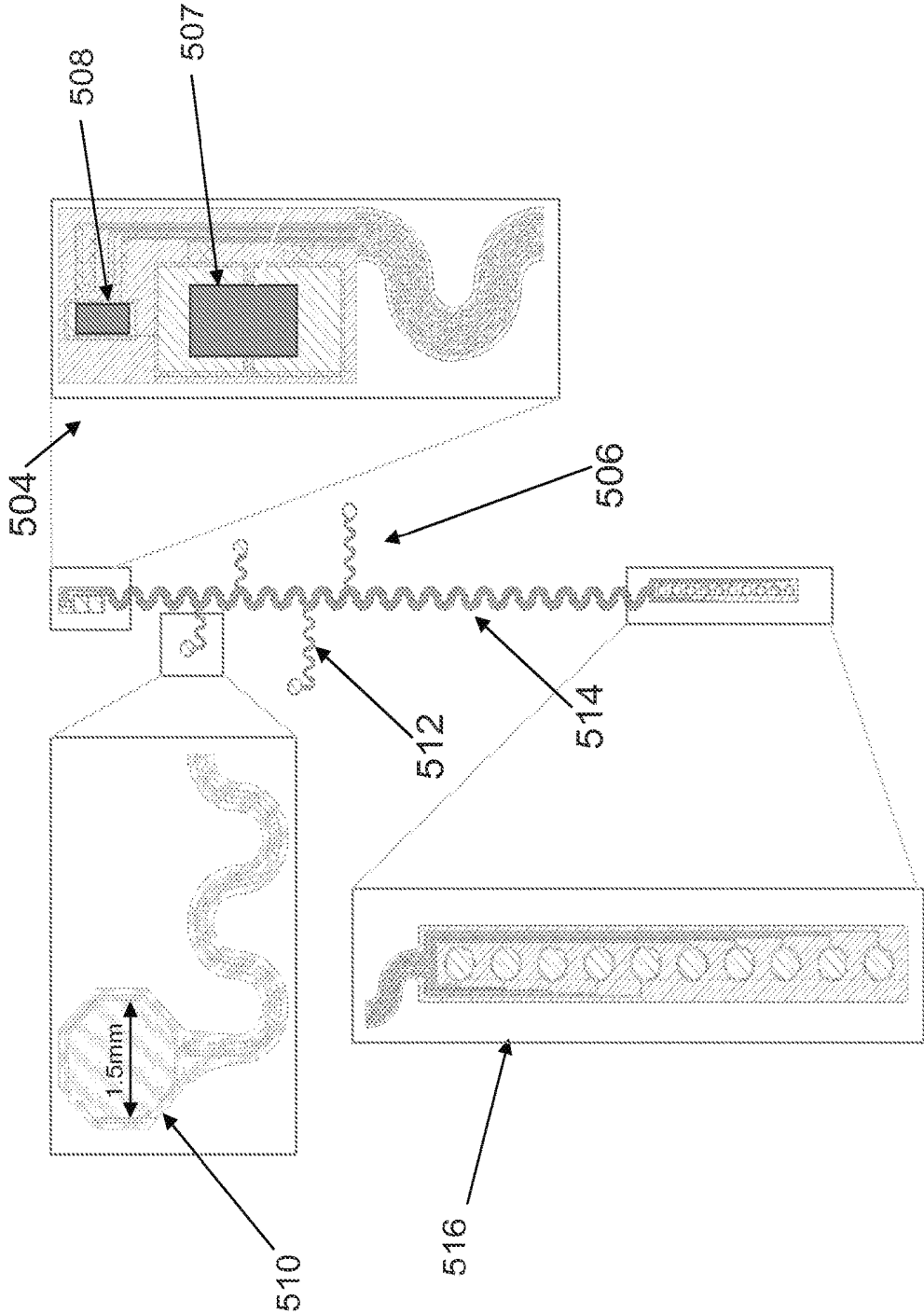

FIG. 5

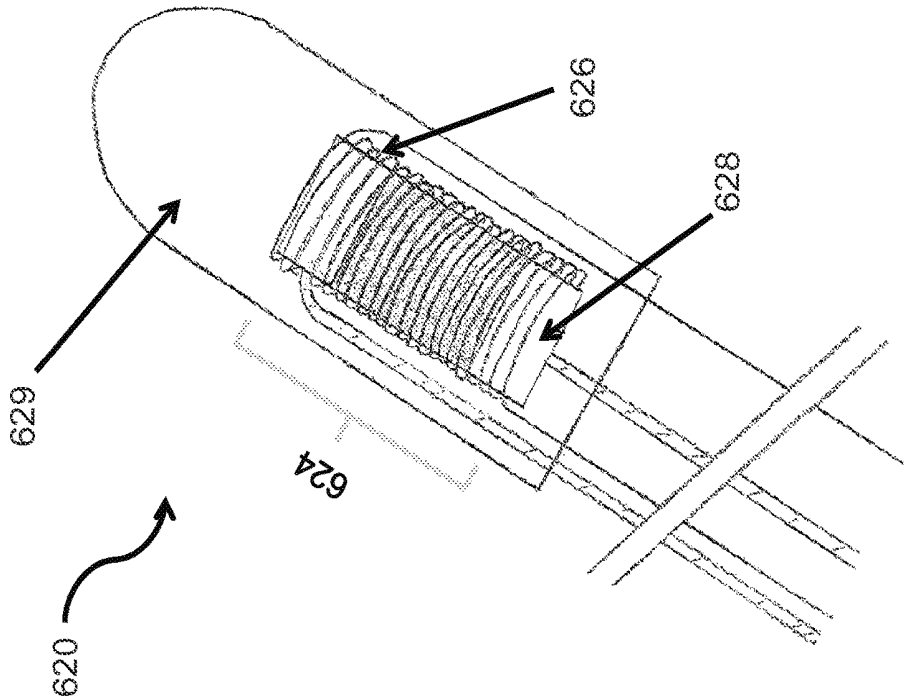

FIG. 6B

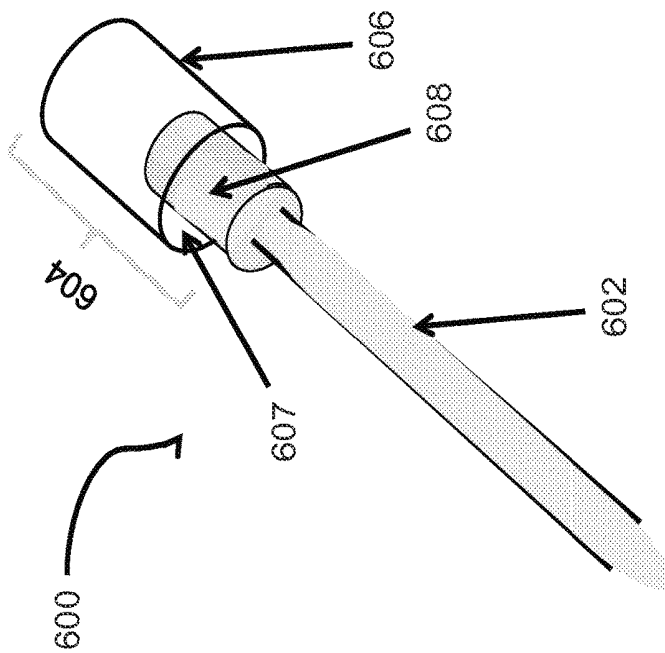

FIG. 6A

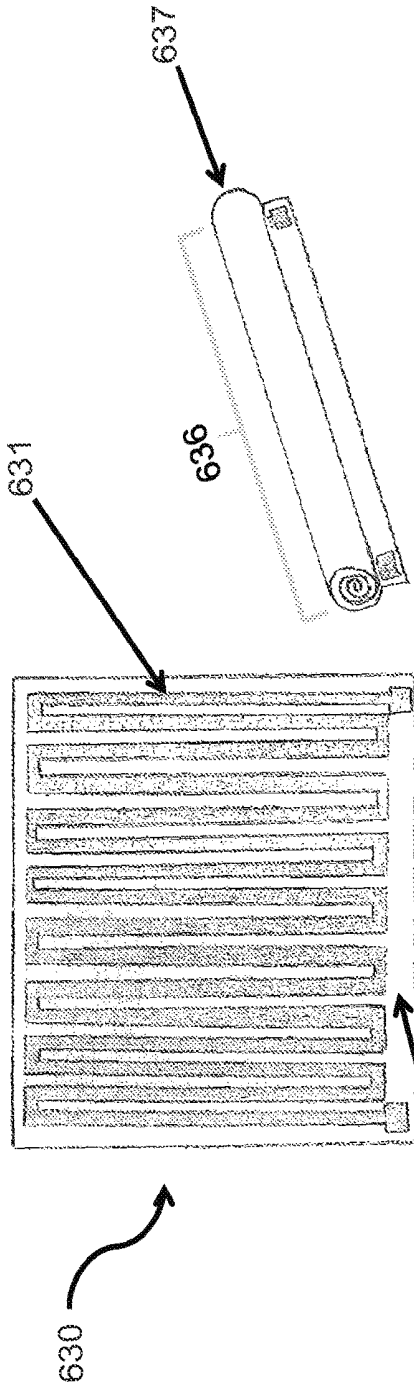

FIG. 6C

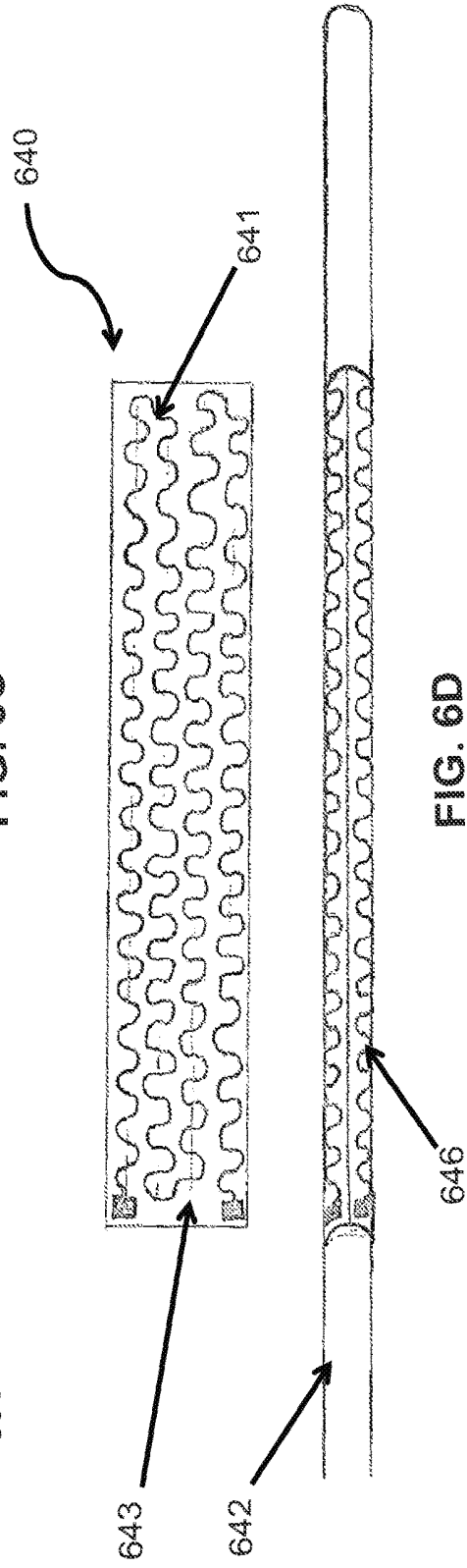

FIG. 6D

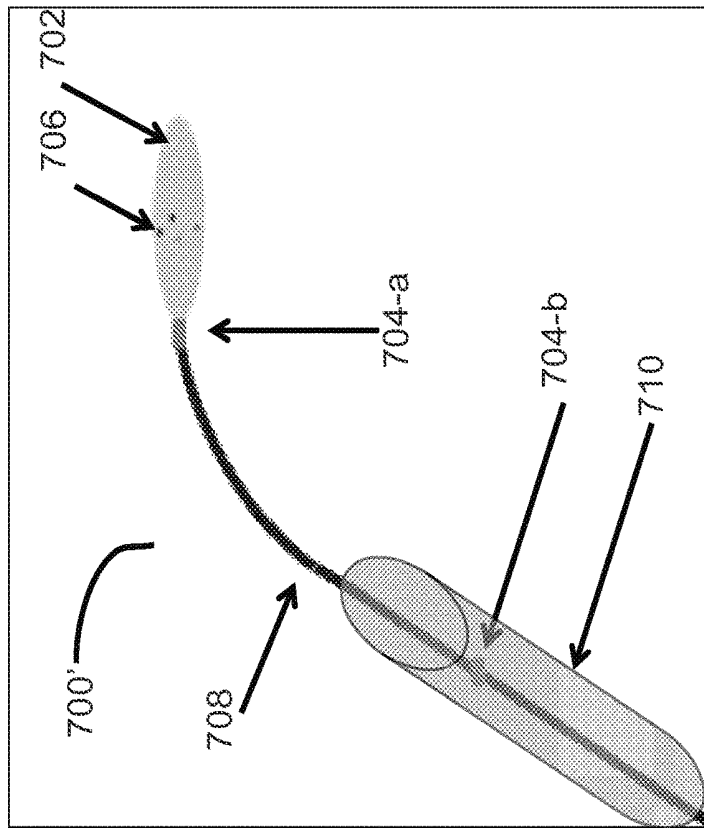

FIG. 7B

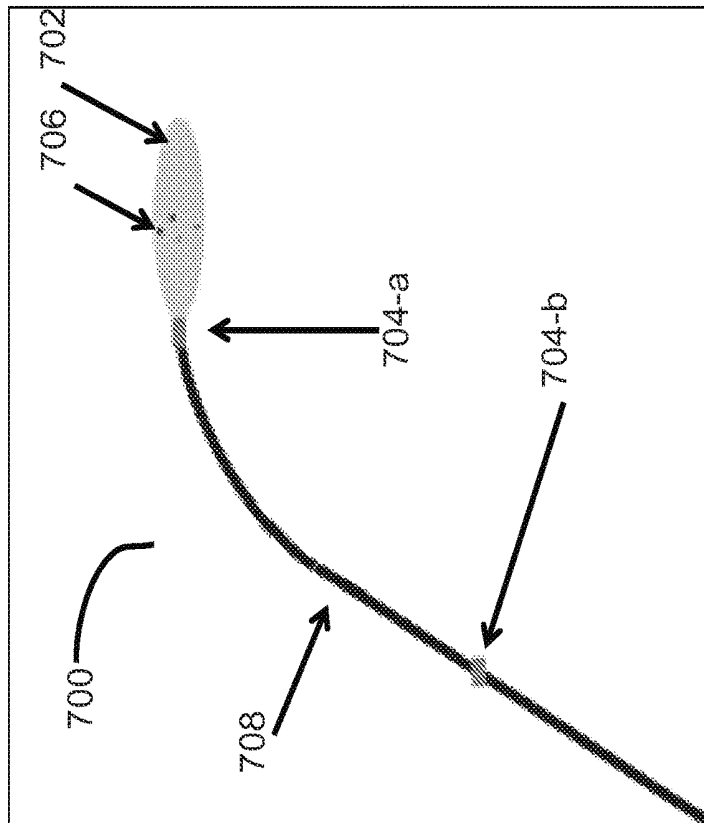

FIG. 7A

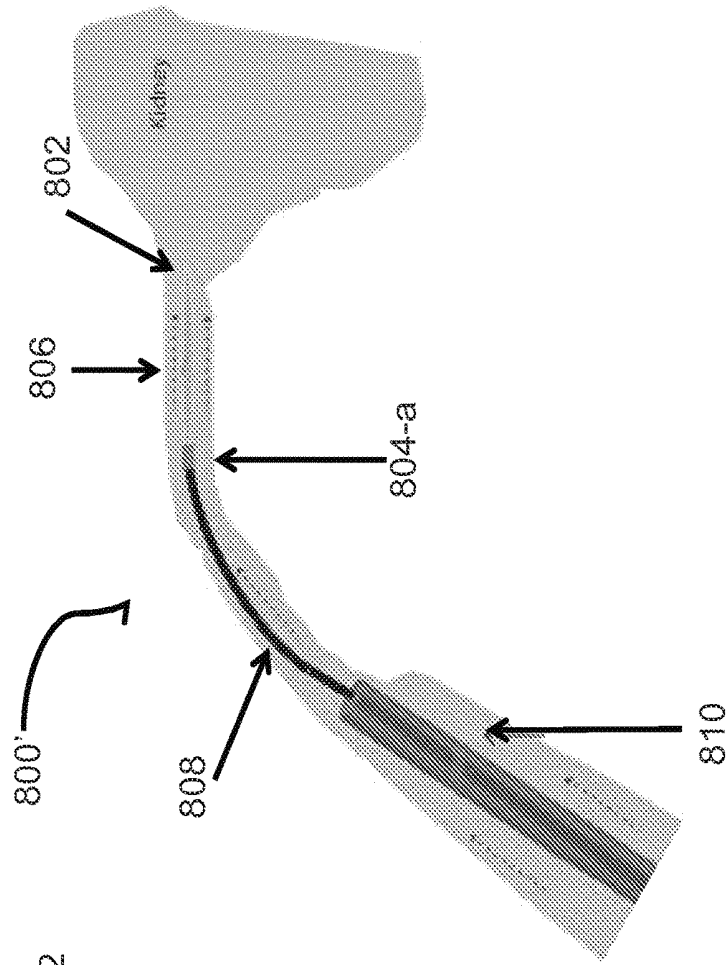

FIG. 8A

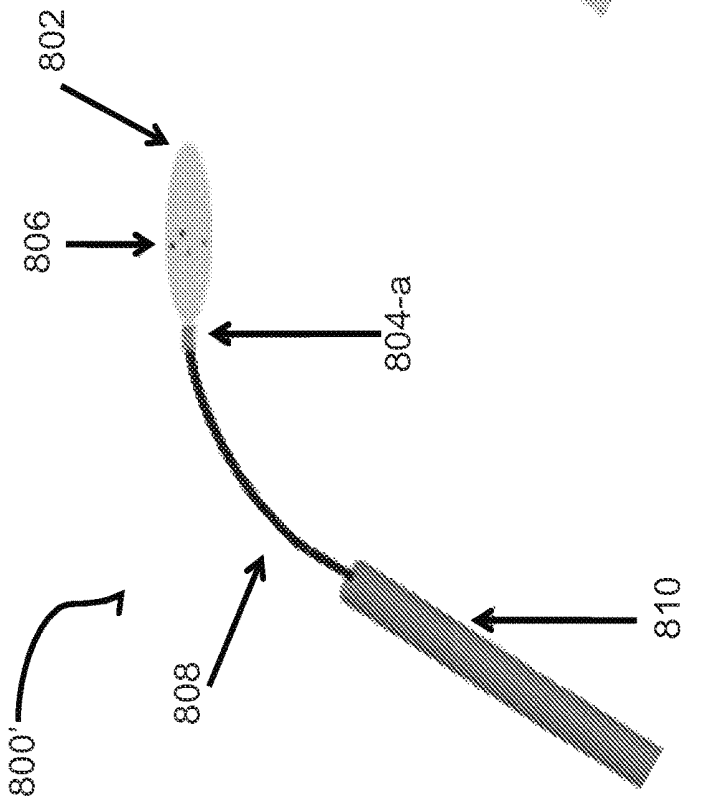

FIG. 8B

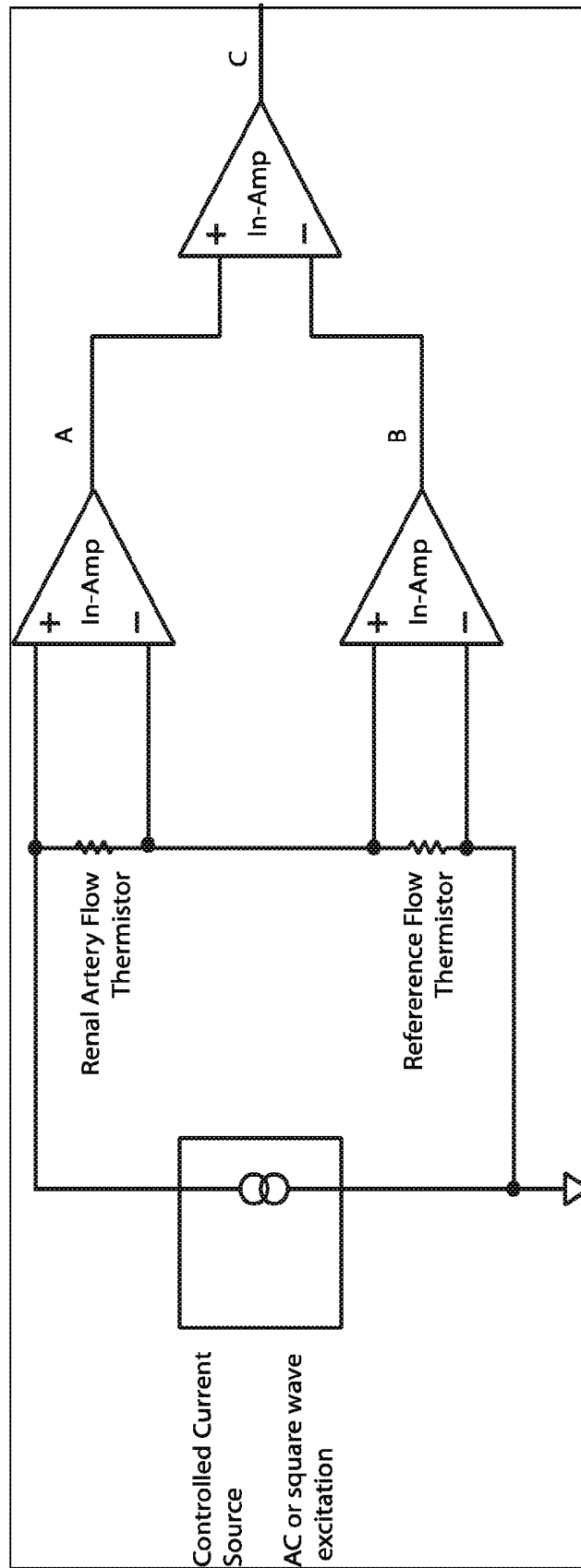

FIG. 9

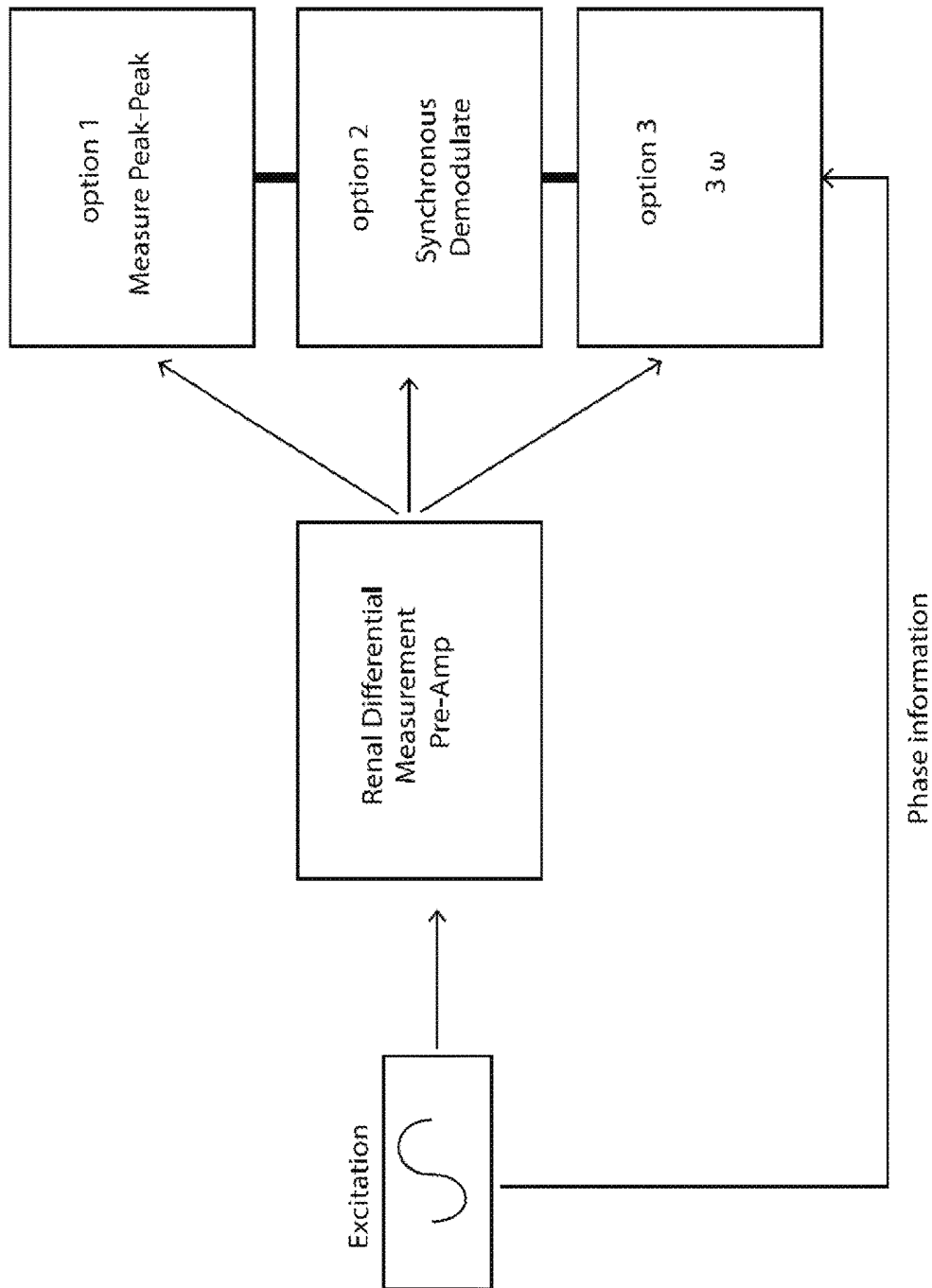

FIG. 10

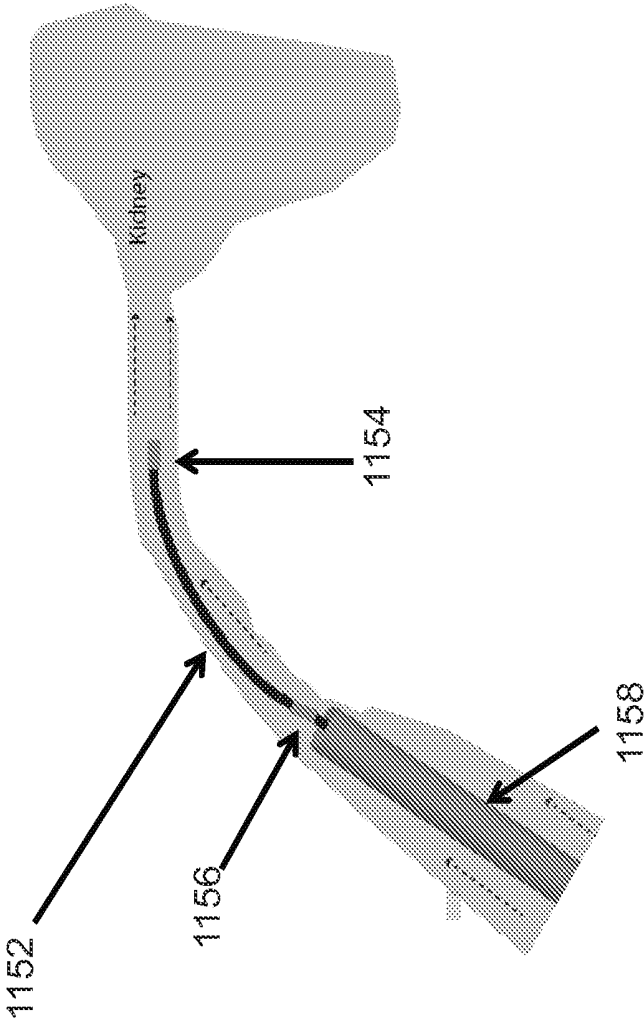
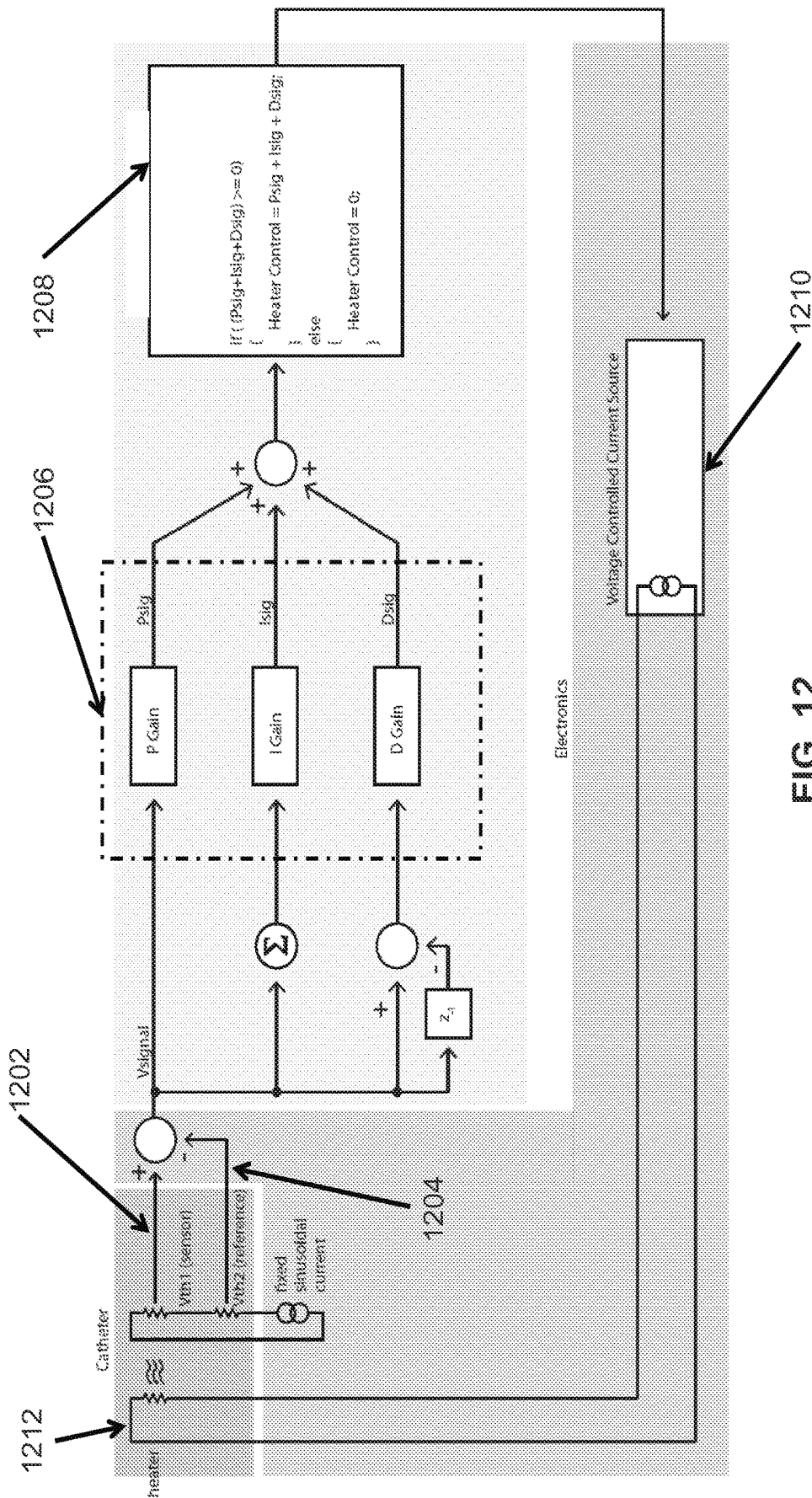

FIG. 11



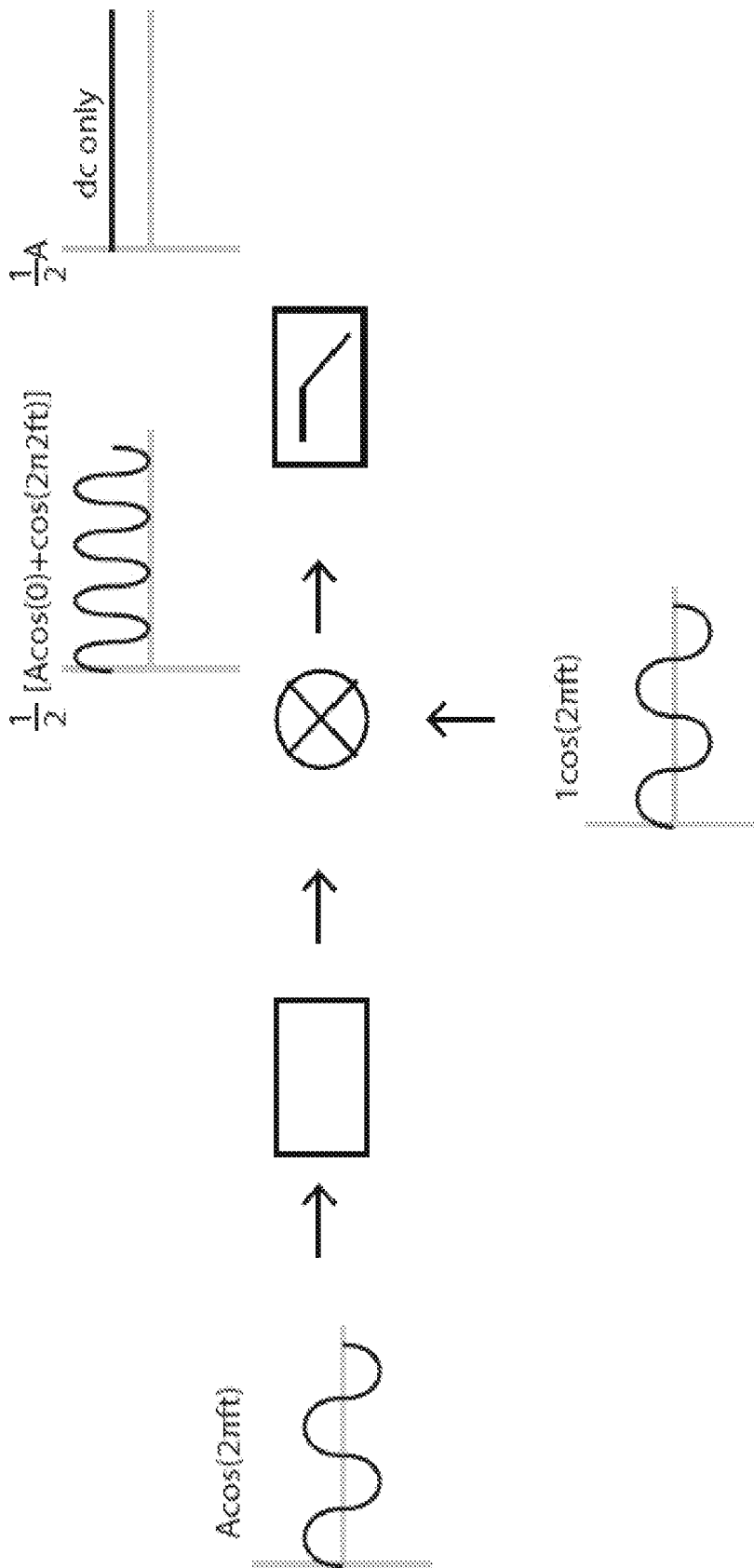

FIG. 13

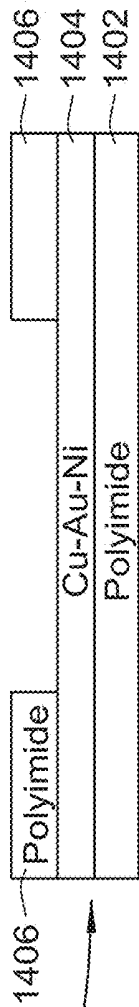

FIG. 14A

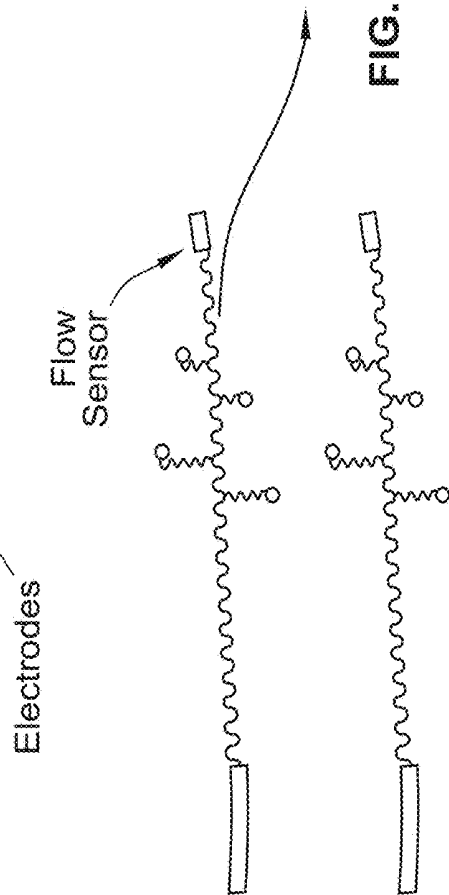

FIG. 14B

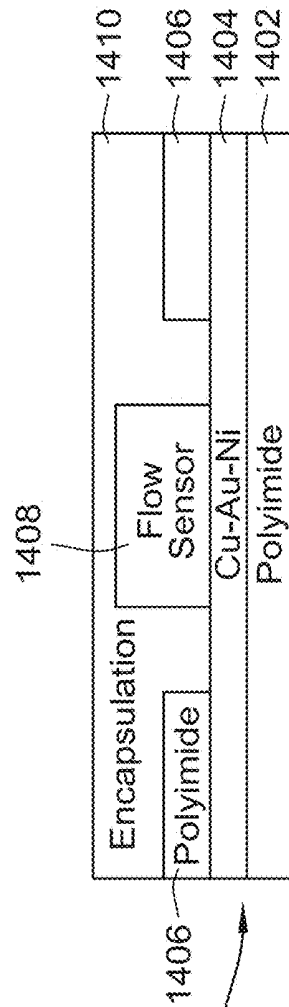

FIG. 14C

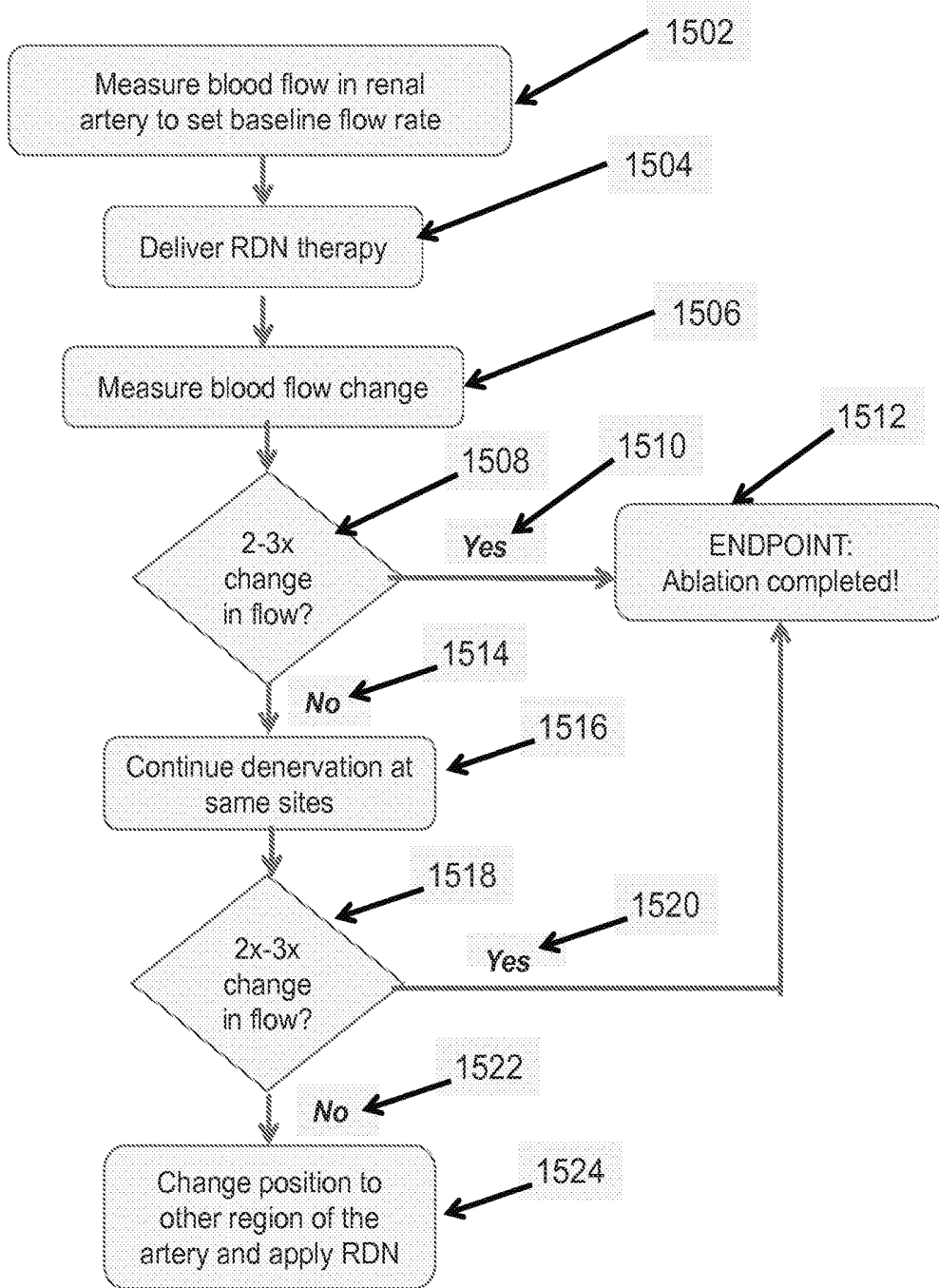

FIG. 15

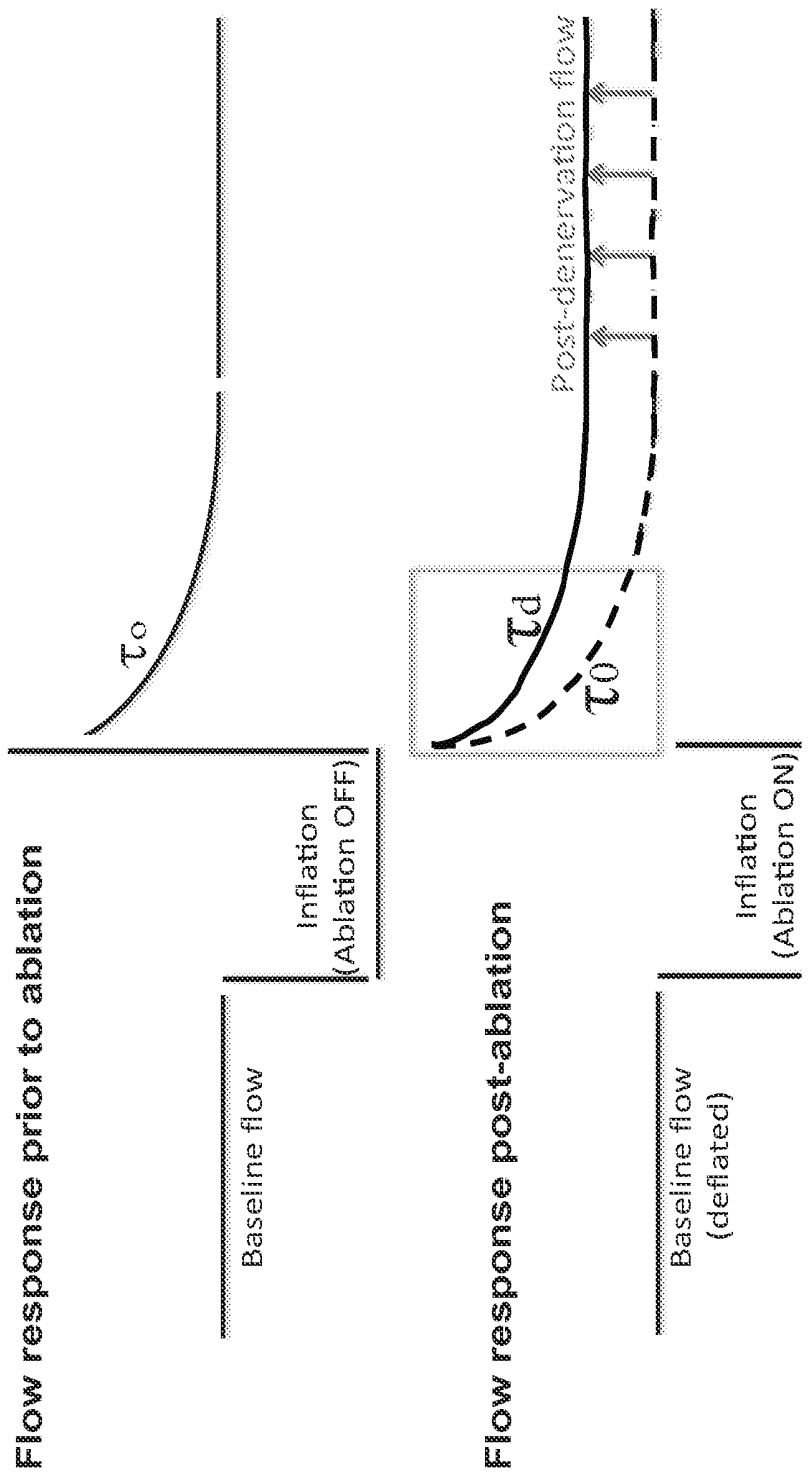

FIG. 16

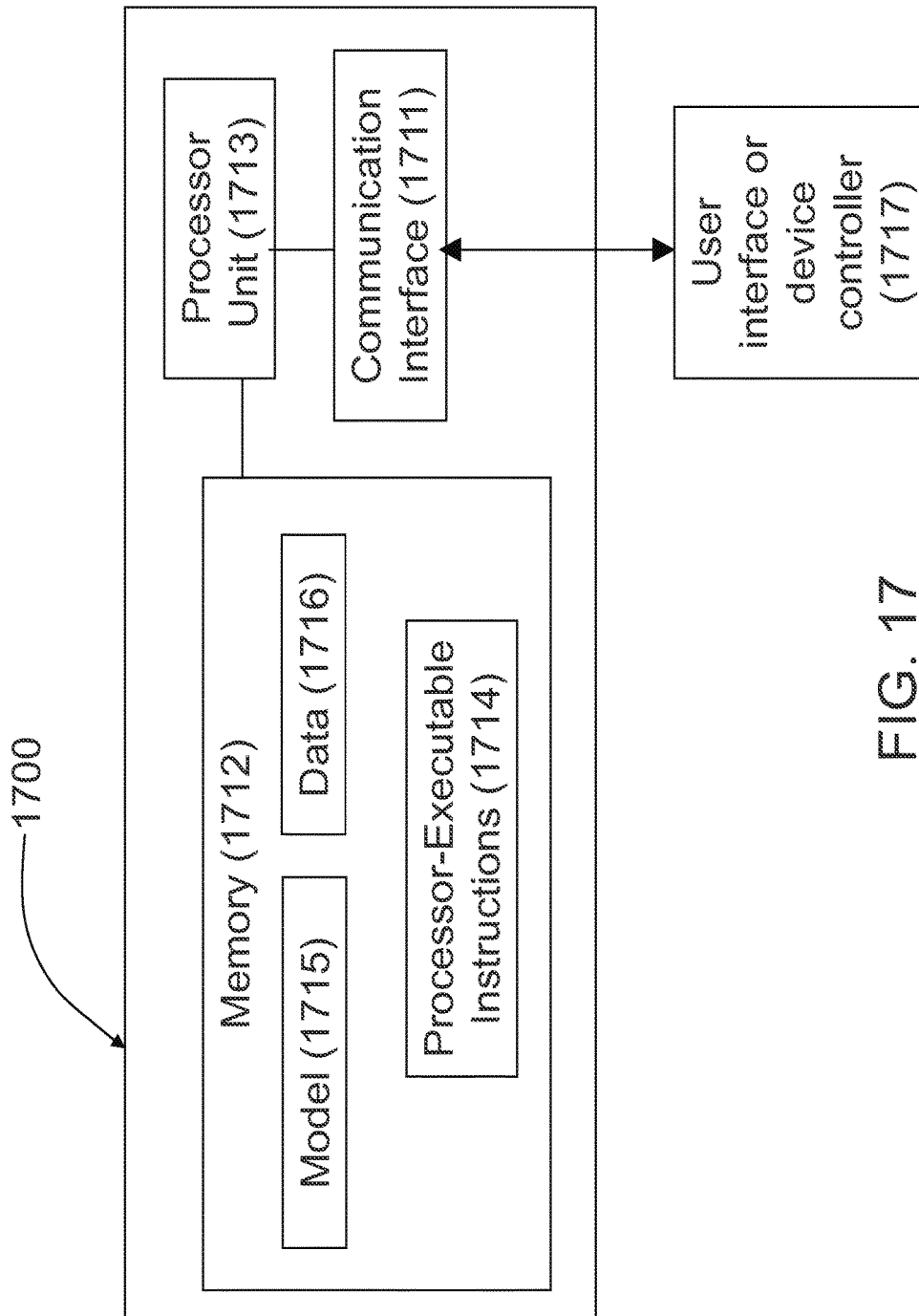

FIG. 17

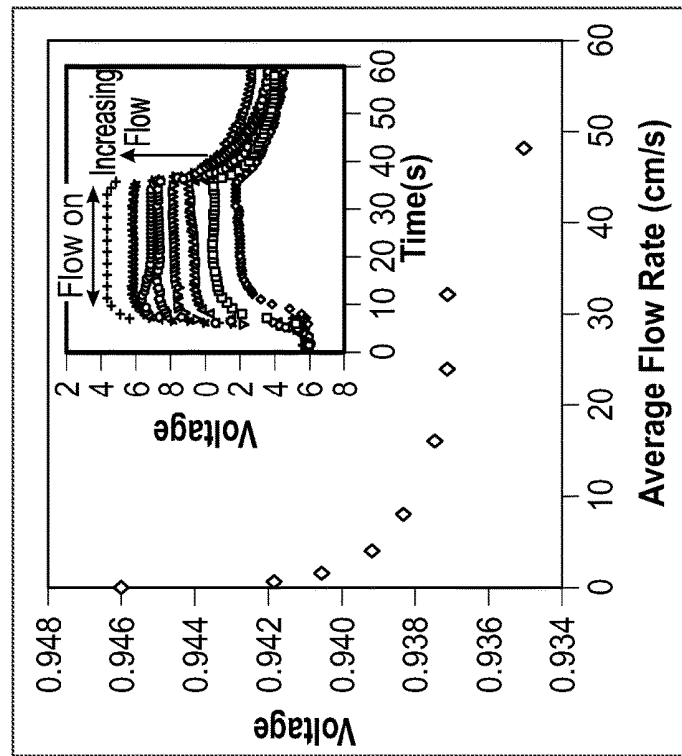

Fig. 18B

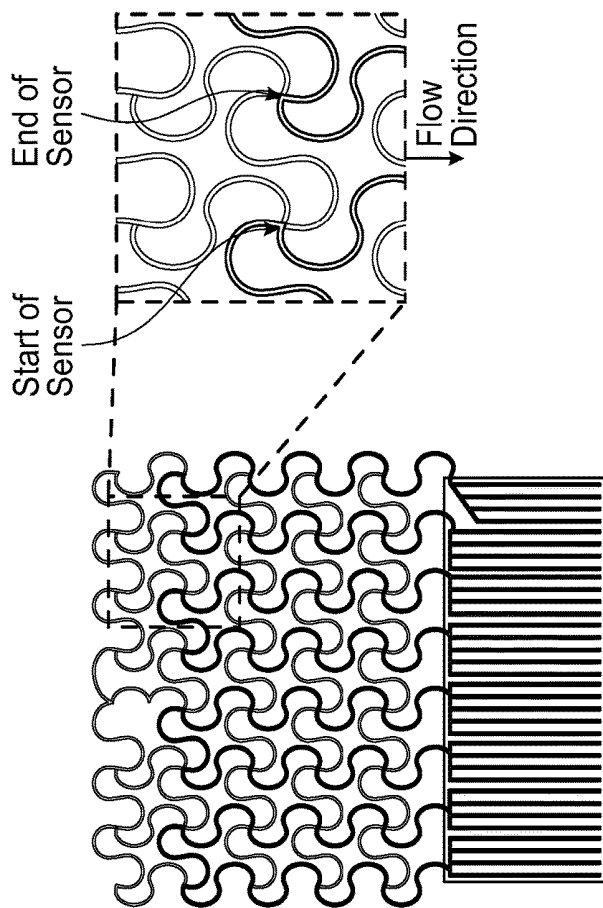

Fig. 18A

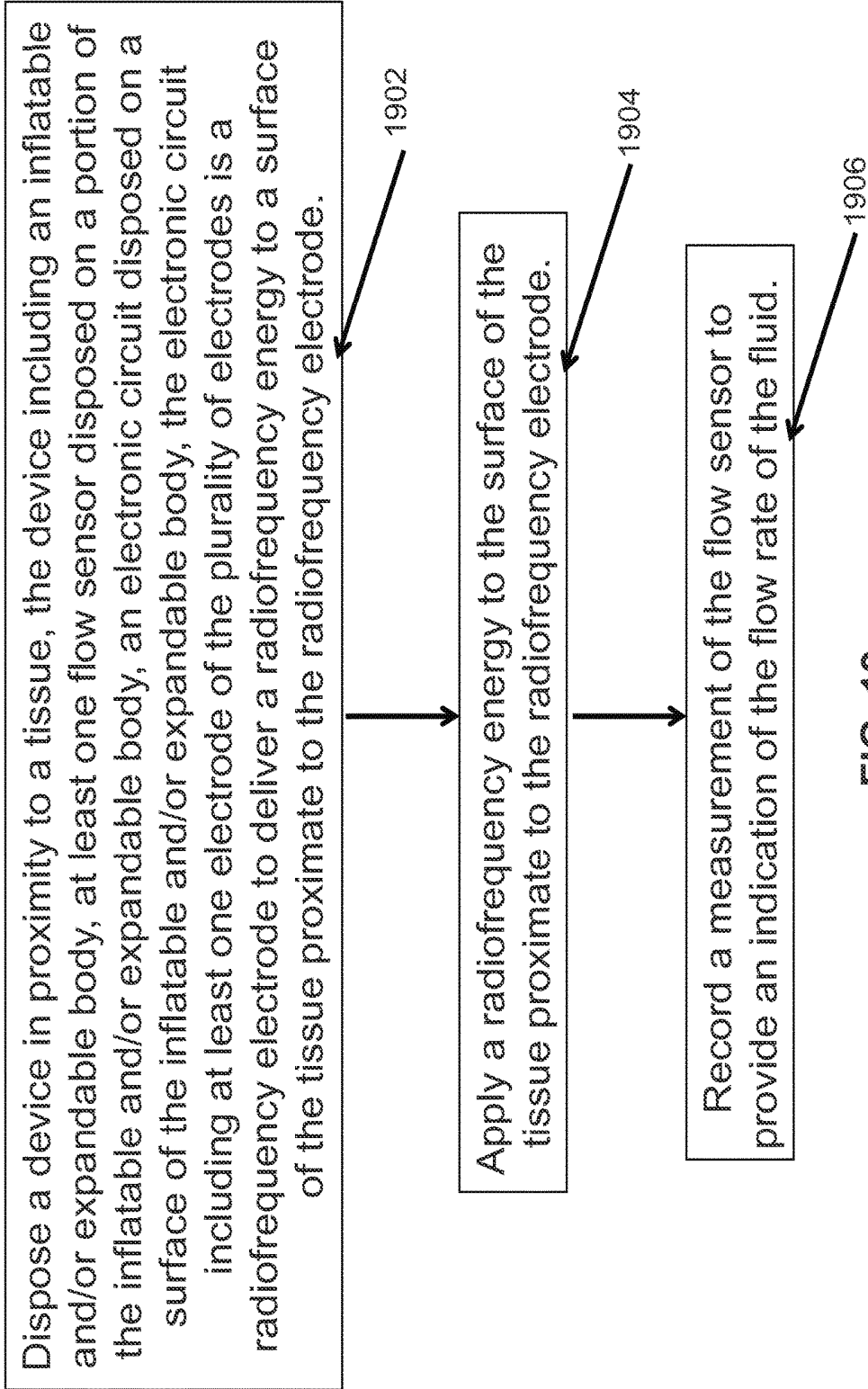

FIG. 19

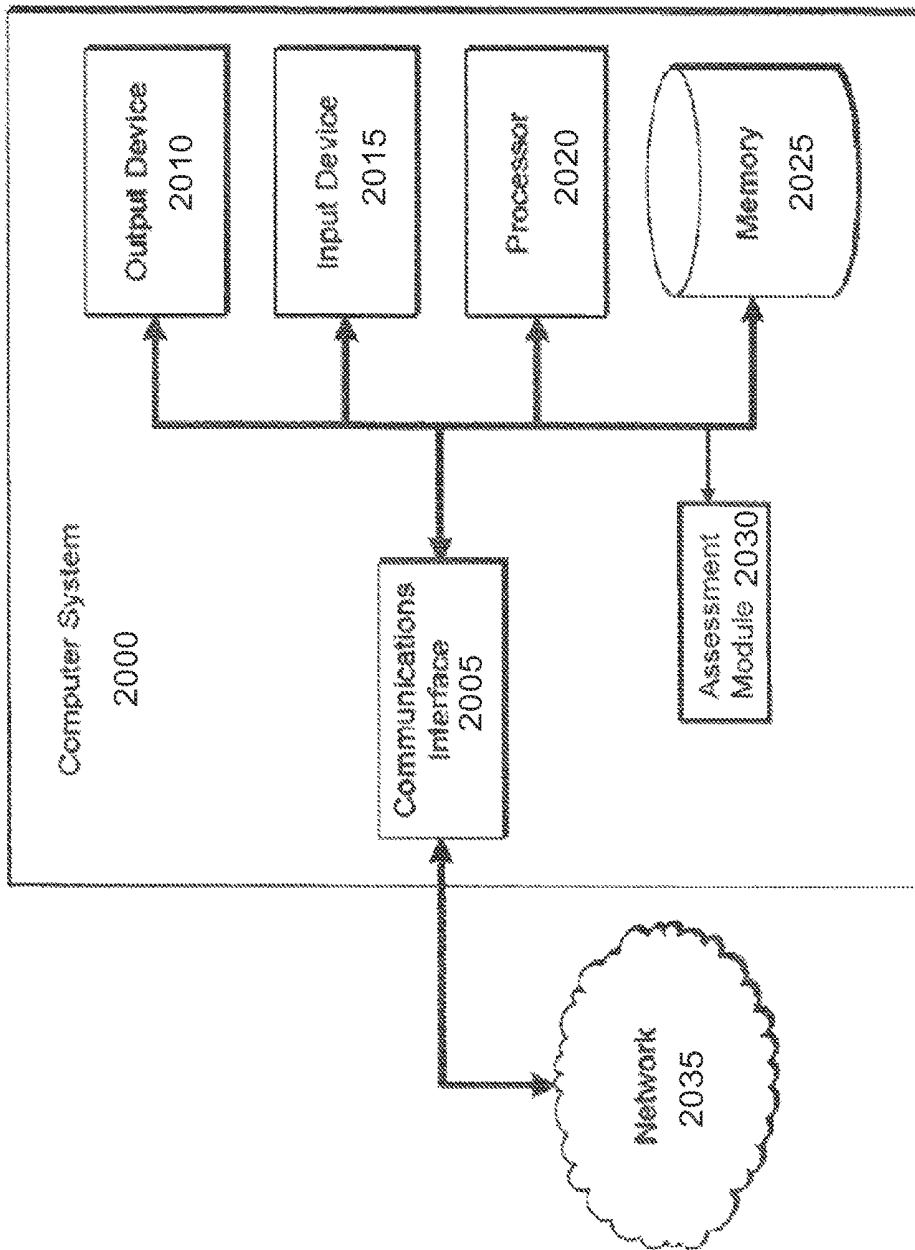

FIG. 20

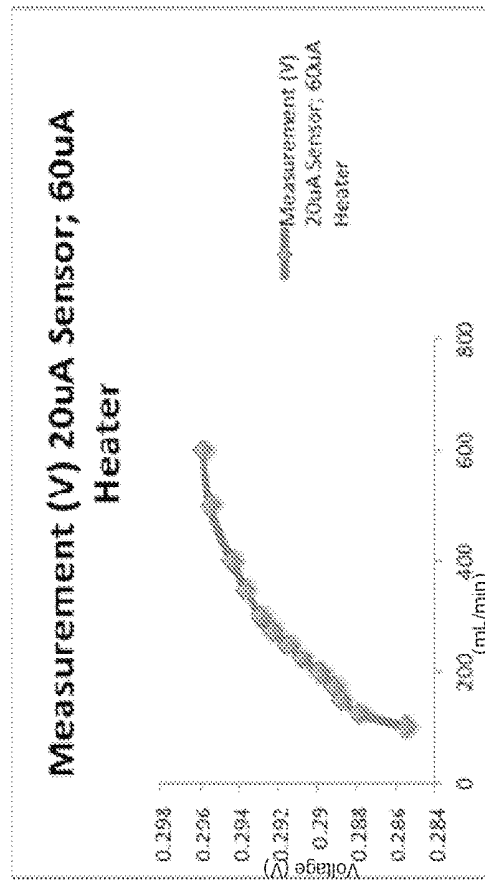

FIG. 21B

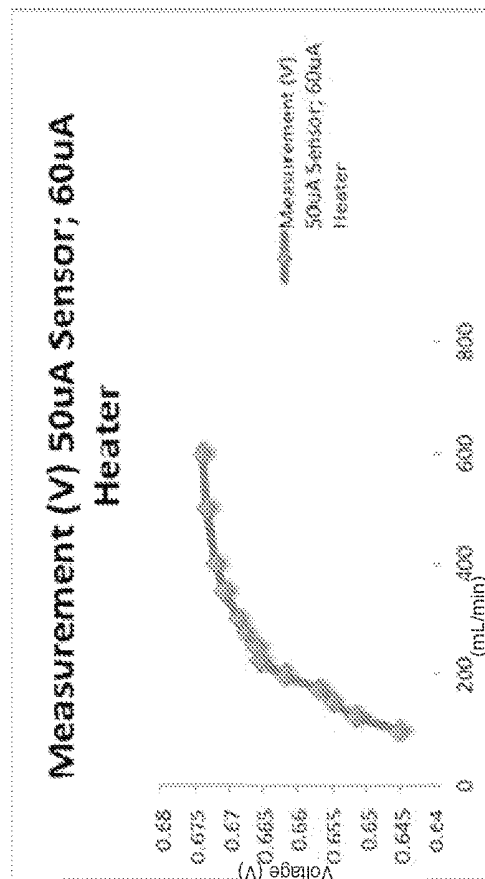

FIG. 21A

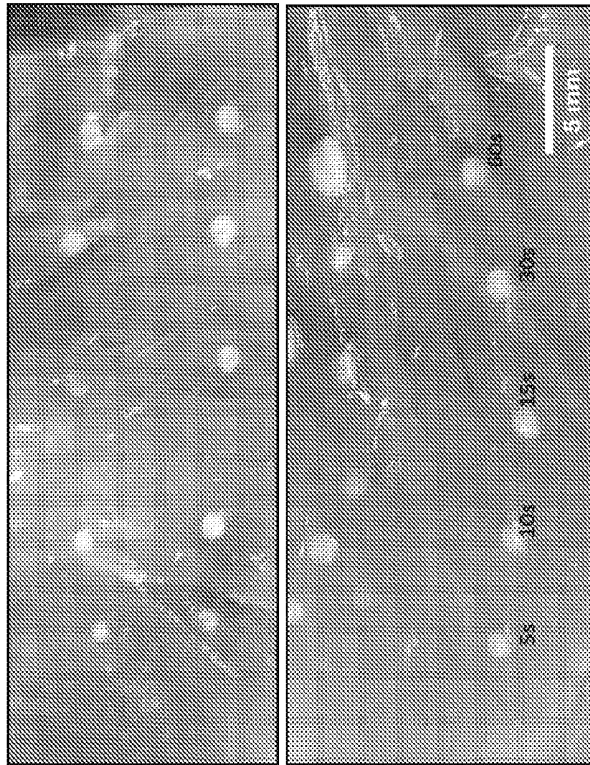
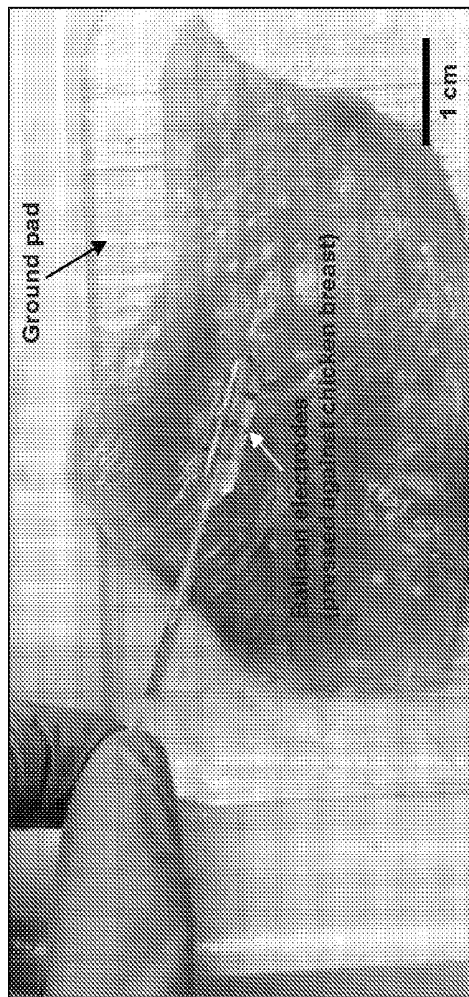

FIG. 22A

FIG. 22B

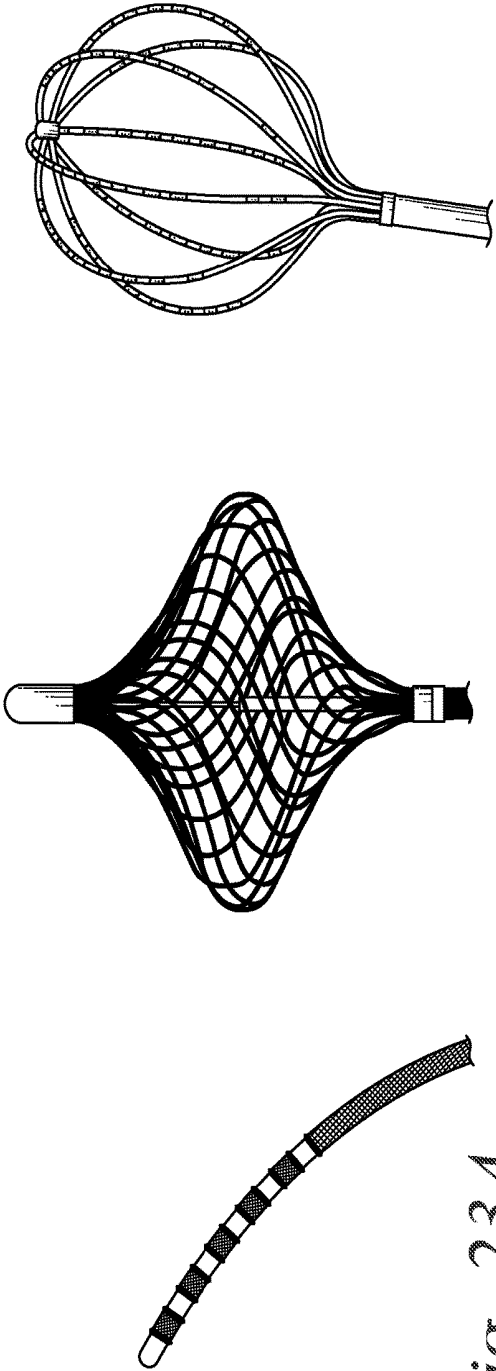

Fig. 23A

Fig. 23B

Fig. 23C

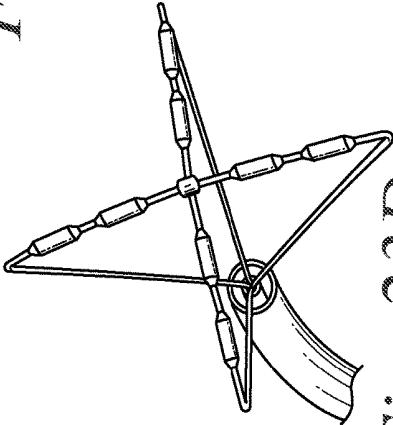

Fig. 23D

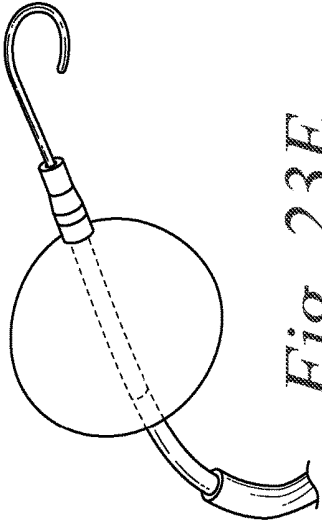

Fig. 23E

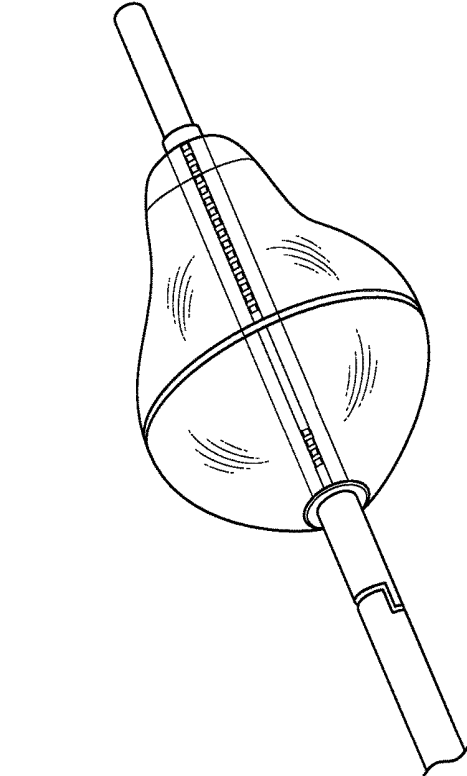

Fig. 23G

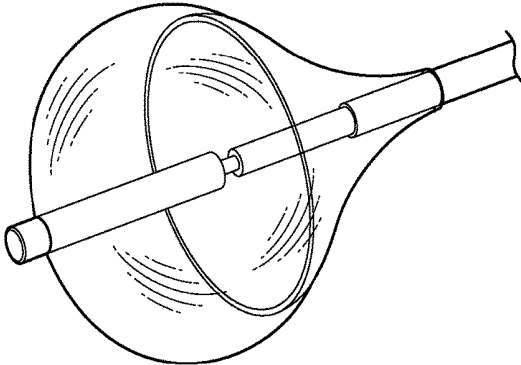

Fig. 23F

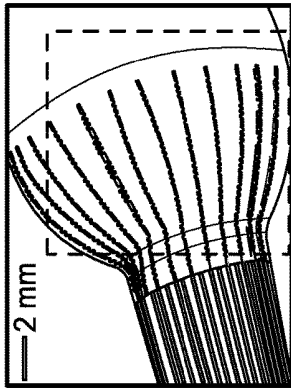

Fig. 24B

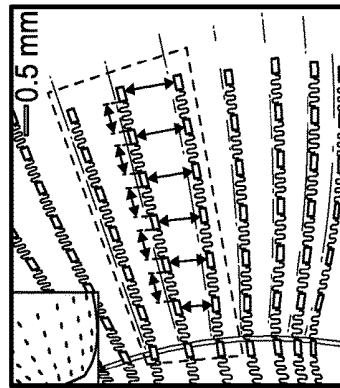

Fig. 24C

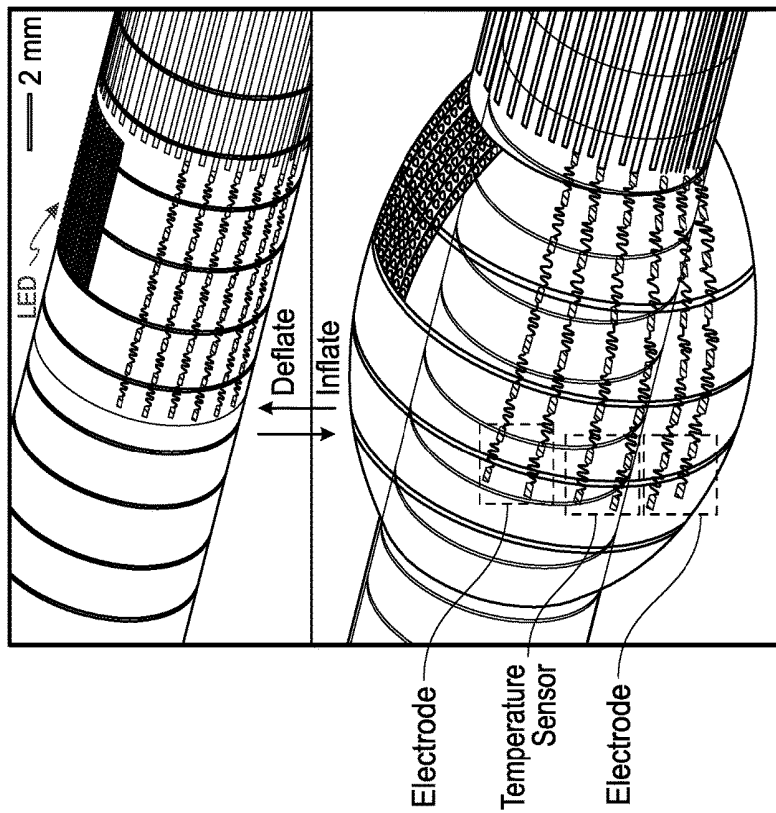

Fig. 24A

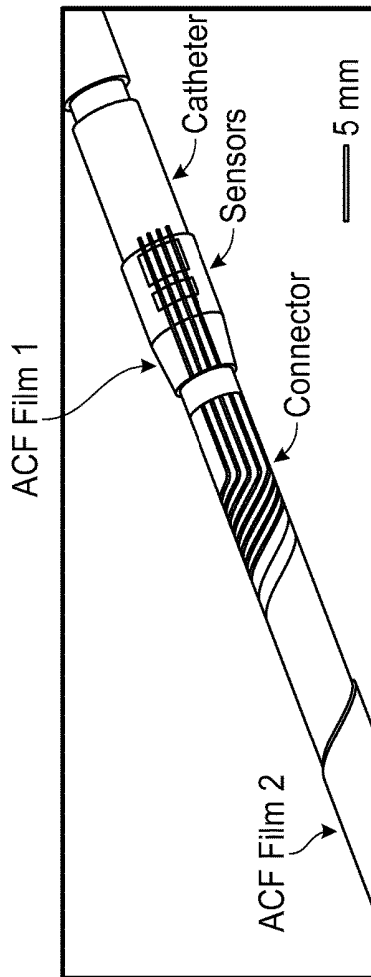

Fig. 24D

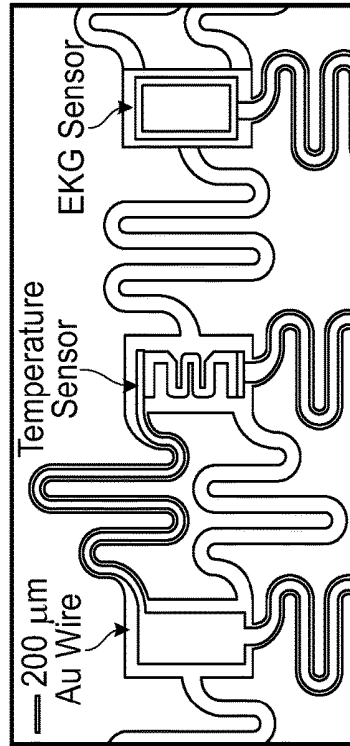

Fig. 24E

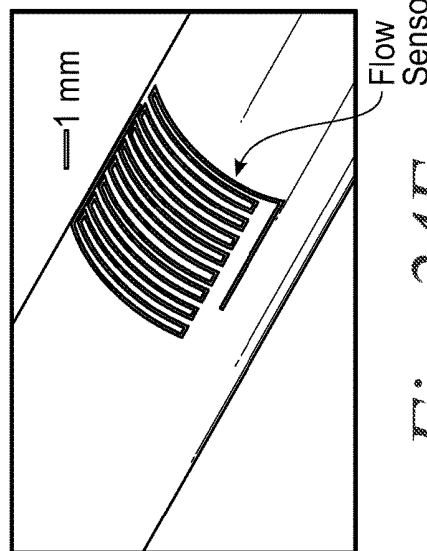

Fig. 24F

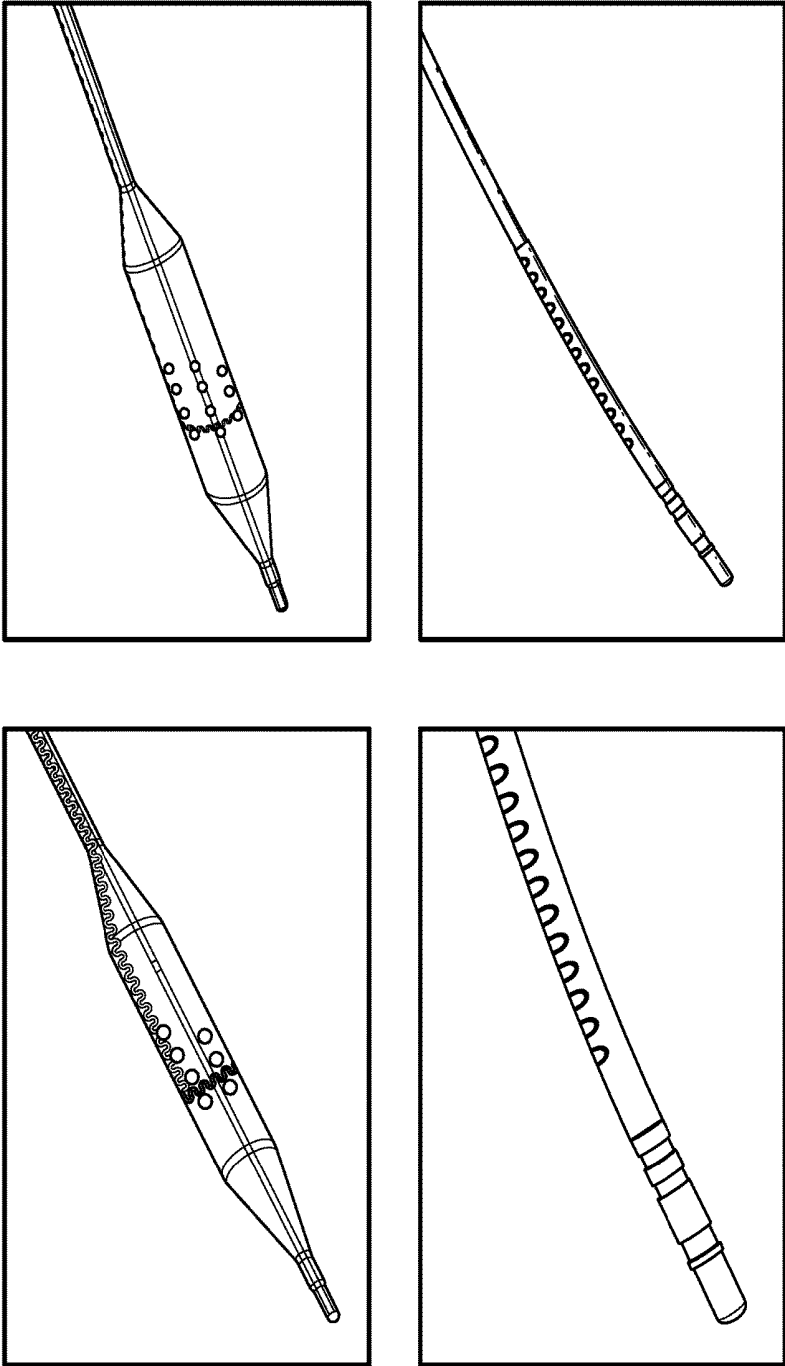

Fig. 25

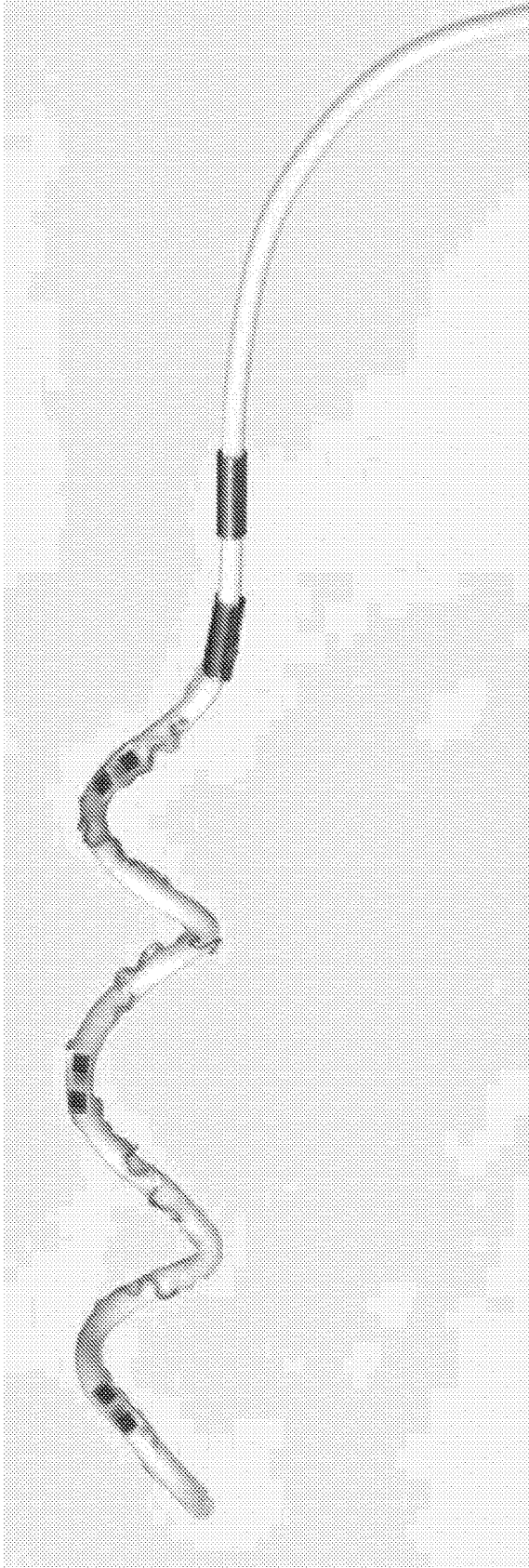

FIG. 26

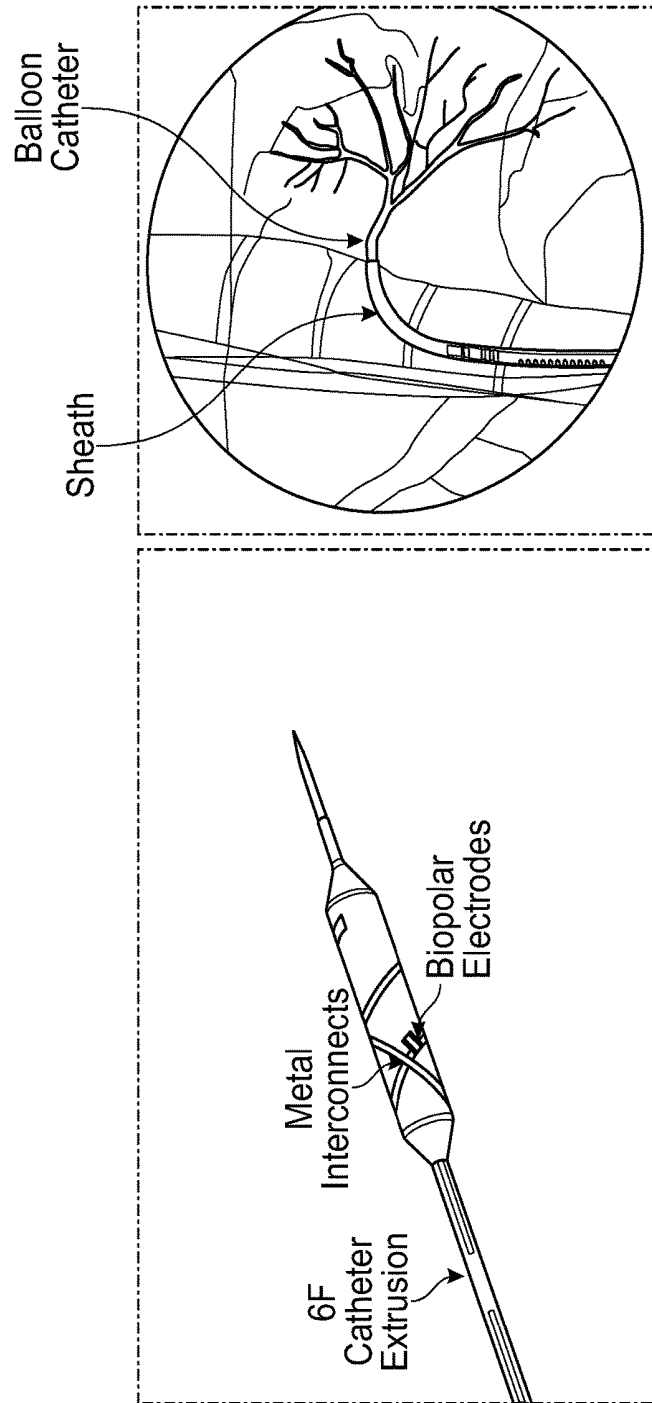

Fig. 27

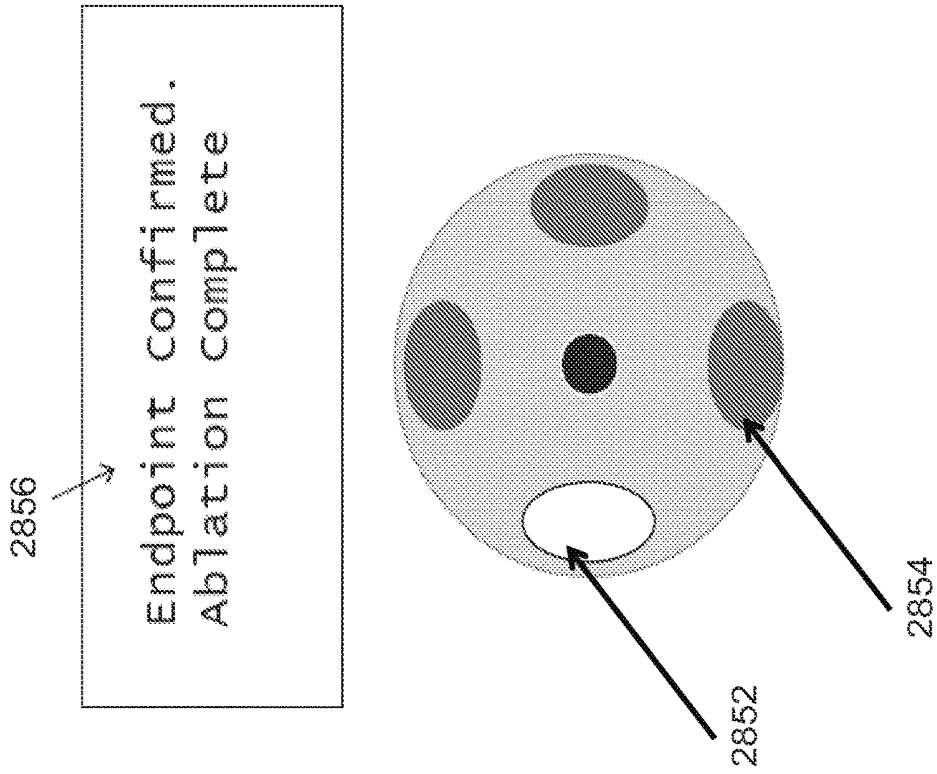

FIG. 28B

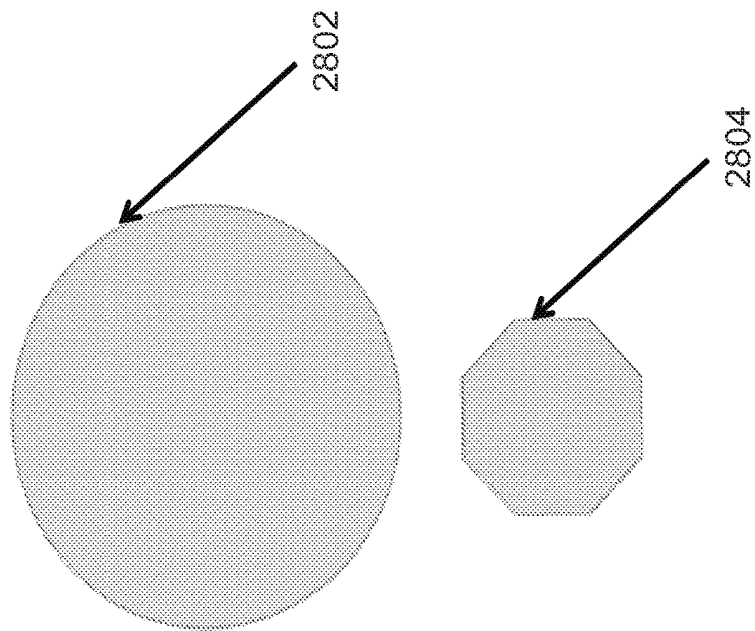

FIG. 28A

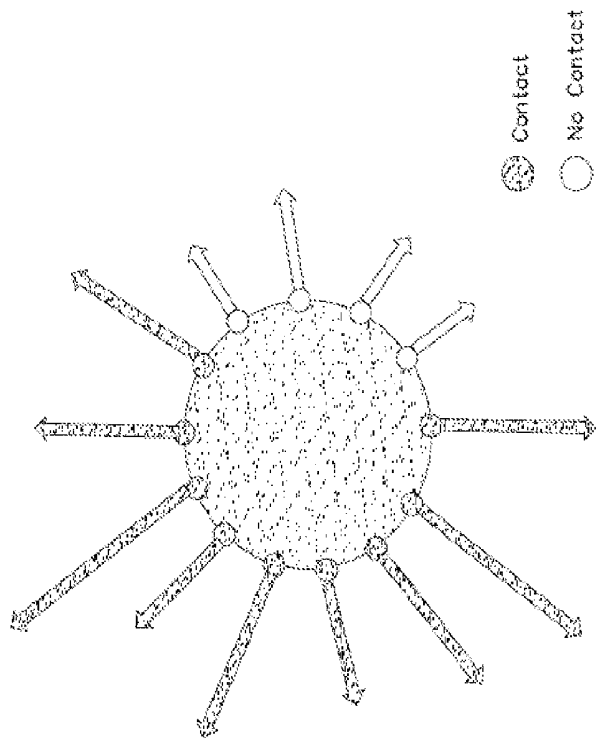

FIG. 28C

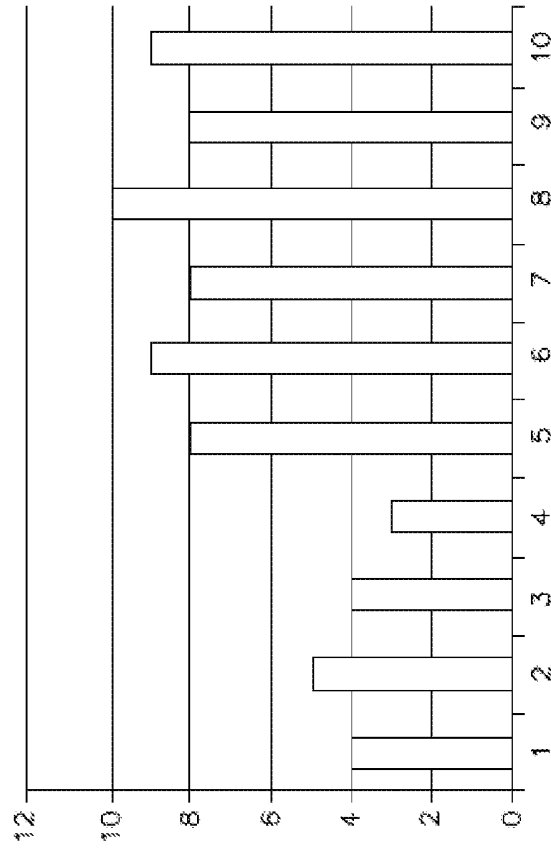

FIG. 28D

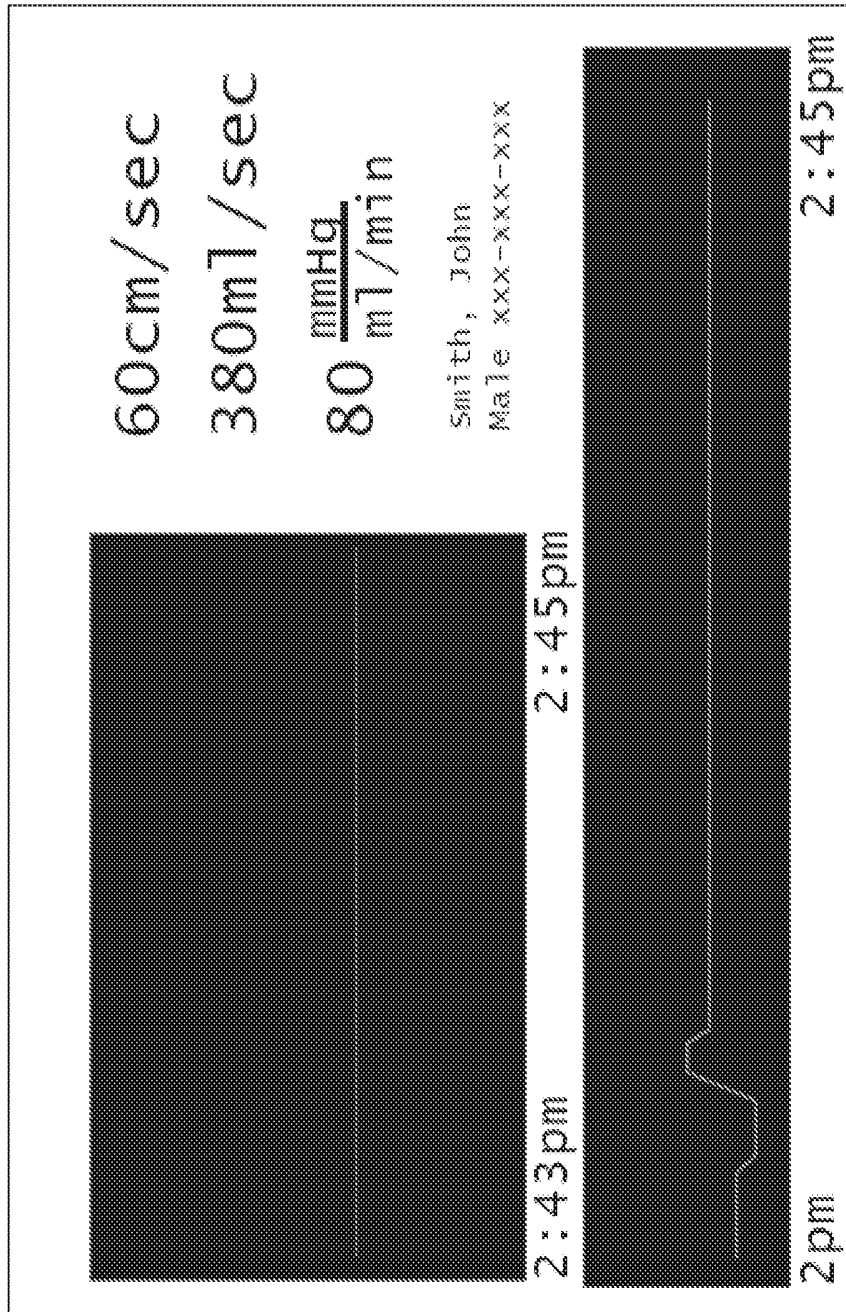

FIG. 29

**CATHETER OR GUIDEWIRE DEVICE
INCLUDING FLOW SENSING AND USE
THEREOF**

CROSS-REFERENCE TO RELATED
APPLICATIONS

This application is a continuation of U.S. patent application Ser. No. 14/147,347, entitled "CATHETER OR GUIDEWIRE DEVICE INCLUDING FLOW SENSING AND USE THEREOF," filed on Jan. 3, 2014, now U.S. Pat. No. 9,295,842, which is a continuation-in-part of U.S. patent application Ser. No. 13/844,677, entitled "CATHETER DEVICE INCLUDING FLOW SENSING," filed on Mar. 15, 2013, now U.S. Pat. No. 9,168,094, which claims the benefit of U.S. provisional application Ser. No. 61/668,338, filed on Jul. 5, 2012, entitled "METHOD AND APPARATUS FOR DENERVATION," U.S. provisional application Ser. No. 61/728,653, filed on Nov. 20, 2012, entitled "RENAL DENERVATION," and U.S. provisional application Ser. No. 61/733,575, filed on Dec. 5, 2012, entitled "INCREASING THE RESOLUTION OF TEMPERATURE MEASUREMENT FOR FLOW DETECTION IN THE RENAL ARTERY," each of which is hereby incorporated herein by reference in its entirety, including drawings.

BACKGROUND

Diseases such as heart disease, stroke and hypertension are global epidemics that affect billions of people worldwide. Hypertension underlies the progression of several debilitating diseases, including heart disease and stroke. Despite widespread use of anti-hypertension medication to counter high blood pressure, the prevalence of hypertension is alarmingly high and constitutes a severe economic burden on health care.

Blood pressure is controlled, in large part, by the sympathetic nervous system. The sympathetic nervous system involves several organs that are responsible for regulating blood pressure such as the brain, heart and kidneys. The kidney is a key element in long-term blood pressure regulation. Hypertension, or high blood pressure, results from hyperactive renal nerves. This, in turn, can cause heart, kidney, and blood vessel damage.

Other systems of the body where nerves activity can affect fluid flow include the carotid sinus, the carotid body, the vagal nerve, the pulmonary artery, the celiac ganglion, and the bladder trigone.

SUMMARY

The Inventors have recognized that an ability to monitor procedures during treatment of tissue is advantageous. For example, renal ablation represents a useful and potentially safe technique. Its applicability may be limited due to a lack of sensing capability following a procedure such as ablation.

In view of the foregoing, various examples described herein are directed generally to systems, apparatus and methods for facilitating the monitoring and/or verification of the outcome of procedures, such as but not limited to a nerve denervation and/or a nerve pacing procedure. The result of the monitoring and/or verification can be used to determine a clinical endpoint of a denervation and/or a pacing procedure. Systems and methods described herein also facilitate establishing a credible endpoint in denervation procedures, including renal sympathetic denervation procedures.

Systems and methods described herein provide novel devices, including catheter devices or guidewire devices, with diagnostic capabilities, to assess the state of the tissue following each procedure, including each ablation cycle of a series of ablation cycles.

Systems and methods described herein provide novel devices, including catheter devices, with diagnostic capabilities, to assess the state of the tissue in other systems, including in pulmonary veins, coronary arteries, and peripheral blood vessels, following each procedure in a series of procedures, such as but not limited to each ablation cycle of a series of ablation cycles.

In an example, a system, apparatus and method herein provide novel devices that can be implemented for measuring blood flow, or other fluid flow, coupled with pacing and/or denervation of nerves, using a single smart catheter or guidewire device.

In an example, a system, apparatus and method herein can be implemented for facilitating monitoring and/or verifying the outcome of denervation and/or pacing procedures performed in one or more systems, such as but not limited to the carotid sinus, the carotid body, the vagal nerve, the pulmonary artery, celiac ganglion, the bladder trigone, or the renal arteries.

In an example, a system, apparatus and method is provided that is based on thin device islands, including integrated circuitry (IC) chips and/or stretchable and/or flexible interconnects that are encapsulated in an encapsulant.

In an example, a system, apparatus and method herein can be implemented for performing a procedure on the portion of tissue, and where the procedure is a denervation procedure or a nerve stimulation procedure. In an example, the procedure can be a carotid sinus denervation, a carotid body disruption, a vagus nerve stimulation, a pulmonary artery denervation, a celiac ganglion disruption, a bladder trigone ablation, or a renal denervation.

In an example, a system, apparatus and method is provided for determining a flow rate of a fluid proximate to a portion of a tissue. An example device according to this principle includes an elongated member having a proximal portion and a distal portion, and a flow sensor disposed proximate to the distal portion of the elongated member. The flow sensor includes at least one temperature sensor and at least one heating element to heat an area proximate to the elongated member, at least a portion of the at least one heating element forming a cavity. At least a portion of the at least one temperature sensor is housed in a portion of the cavity. A temperature measurement of the temperature sensor provides a first indication of a flow rate of the fluid proximate to the flow sensor.

In an example, the device can further include an inflatable and/or expandable body coupled to a portion of the elongated member and having a proximal portion and a distal portion. The distal portion of the inflatable and/or expandable body is disposed proximate to the flow sensor. The example device can further include an electronic circuit coupled with the inflatable and/or expandable body, where the electronic circuit comprises at least one stretchable interconnect, and where the electronic circuit is stretchable and conformable such that the electronic circuit accommodates an expansion of the inflatable and/or expandable body. The electronic circuit can further include at least one passive electronic component and/or at least one active electronic component, and wherein the at least one stretchable interconnect electrically couples at least two electronic components of the electronic circuit.

In an example, the device can include at least one heating element is comprised of a coiled resistive wire, where a hollow portion of the coiled resistive wire forms the cavity. In another example, the at least one heating element can include a thin-film patterned resistive element, where the at least one heating element is formed in a substantially cylindrical conformation including the cavity. In another example, the thin-film patterned resistive element can include a pattern of resistive elements disposed on a stretchable and/or flexible substrate. The resistive elements may be formed in a linear pattern, a serpentine pattern, a boustrophedonic pattern, a zig-zag pattern, a wavy pattern, a polygonal pattern, or a substantially circular pattern.

In an example, a system, apparatus and method herein is provided for displaying representations of parameters of an inflatable body and/or expandable body disposed proximate to a portion of a tissue. In an example, the inflatable body and/or expandable body includes a plurality of sensors coupled to at least a portion of the inflatable body and/or expandable body. An example apparatus can include a user interface, at least one memory to store processor-executable instructions, and at least one processing unit communicatively coupled to the at least one memory. Upon execution of the processor-executable instructions, the at least one processing unit can control the user interface to display at least one representation of the parameters. The at least one representation includes: (A) a first representation of a state of the inflatable body and/or expandable body and (B) a second representation of a state of at least one sensor of the plurality of sensors. The first representation can include (i) a first form indicator to indicate that the inflatable body and/or expandable body is in an inflated and/or an expanded state, or (ii) a second form indicator to indicate that the inflatable body and/or expandable body is in a deflated and/or a collapsed state. The second representation can include (i) a first activation indicator to indicate that the at least one sensor of the plurality of sensors measures a signal below a threshold value, or (ii) a second activation indicator to indicate that the at least one sensor of the plurality of sensors measures a signal above or about equal to the threshold value.

In an example implementation of the apparatus, a signal below a specified (threshold) value indicates that the at least one sensor is not in contact with a portion of the tissue, and a signal above or about equal to the specified (threshold) value indicates that the at least one sensor is in contact with a portion of the tissue.

In an example implementation of the apparatus, the first activation indicator and the second activation indicator can be displayed as binary visual representations and/or as quantitative visual representations that correspond to a magnitude of the signal.

In an example implementation of the apparatus, the at least one processing unit can be used to control the user interface to cause display of the first representation and the second representation in a staged process, such that no second representation is displayed while the first representation is the first form indicator, and the second representation is displayed once the first representation is the second form indicator.

In an example implementation of the apparatus, the at least one processing unit can be used to control the user interface to further cause display of an indication of at least one stage of a procedure being performed on the portion of the tissue and/or an indication of an endpoint of a procedure being performed on the portion of the tissue.

In an example, a system, apparatus and method herein can be implemented for performing a medical treatment procedure. An example method can include disposing in proximity to the tissue an apparatus that includes an elongated member having a proximal portion and a distal portion, at least one flow sensor disposed proximate to the distal portion of the elongated member, and a reference temperature sensor disposed on a proximal portion of the elongated member. Each of the at least one flow sensor includes at least one temperature sensor, and at least one heating element disposed proximate to the at least one temperature sensor. The example apparatus can include a control module coupled to the at least one flow sensor and the reference temperature sensor. The example method includes using the control module to maintain a temperature difference between the reference temperature sensor and the temperature sensor of the at least one flow sensor at a stage of performance of the medical treatment procedure. Use of the example control module includes monitoring a value of a temperature measurement of the reference temperature sensor and/or a temperature measurement of the temperature sensor of the at least one flow sensor, and controlling a first signal to the at least one heating element to cause the at least one heating element to emit heat or discontinue emitting heat, such that that the temperature difference is maintained.

In an example implementation of the method, the temperature difference can be a constant temperature difference or a time-varying temperature difference. In an example the temperature difference can be a constant temperature difference, where the constant temperature difference is about 1.5° C., about 2.0° C., about 2.5° C., about 3.0° C., about 3.5° C., about 4.0° C., or about 4.5° C.

In an example implementation, the example control module includes a proportional-integral-derivative (PID) controller or an anemometer. Where the control module includes a PID controller, the method can further include applying the PID controller to compare the value of the temperature measurement of the reference temperature sensor to the temperature measurement of the temperature sensor of at least one flow sensor, and to determine a second signal based on the comparison, and using the control module to determine the first signal to the at least one heating element based on the second signal.

In an example implementation of the method, stages of the method can be repeated until the difference falls in a specified range of values.

In an example, a system, apparatus and method herein can be implemented for monitoring a hemodynamic effect during a medical treatment procedure performed on a vascular tissue. An example method can include disposing in proximity to the tissue an apparatus that includes an elongated member having a proximal portion and a distal portion, at least one flow sensor disposed proximate to the distal portion of the elongated member, and at least one component coupled to the elongated member to perform a medical treatment procedure on a portion of the tissue proximate to the elongated member. The example method can further include activating the at least one component to perform the medical treatment procedure on the portion of the tissue, administering a substance that causes a change in dimension of the vascular tissue, using the at least one flow sensor to perform at least one flow measurement, the at least one flow measurement providing data indicative of a change in the flow subsequent to the medical treatment procedure of a fluid proximate to the apparatus, and analyzing the data indicative of the flow of the fluid to determine at least one parameter indicative of the change in the hemodynamics of

the fluid. A reduction in the change in the hemodynamics of the fluid is used to provide an indication of the efficacy of the medical treatment procedure.

In an example implementation of the method, stages of the method can be repeated until the rate of reduction of the change in the hemodynamics of the fluid falls below a specified value. The example method can further include generating an indication of an endpoint of the medical treatment procedure when the rate of reduction of the change in the hemodynamics of the fluid falls below the specified value.

In an example implementation of the method, the substance can include an endogenous substance or an exogenous substance. For example, the substance can include a dopamine, adenosine, prostacyclin, saline, or nitric oxide. The at least one component can be an ablative component, where the medical treatment procedure is a denervation procedure.

An example system, apparatus and method herein provides a catheter or guidewire device for performing a procedure on tissue. The catheter or guidewire device includes an inflatable and/or expandable body disposed near a distal end of the catheter, at least one flow sensor disposed on the inflatable and/or expandable body. At least one component is coupled to the catheter or guidewire to perform an ablation procedure on a portion of the tissue of the renal artery. Each of the at least one flow sensors includes a heating element to heat an area proximate to the inflatable and/or expandable body, the heating element including a cavity, and a temperature sensor at least partially disposed in the cavity of the heating element. Measurement of the temperature sensor provides an indication of a flow rate of a fluid proximate to the inflatable and/or expandable body.

The following publications, patents, and patent applications are hereby incorporated herein by reference in their entirety:

Kim et al., "Stretchable and Foldable Silicon Integrated Circuits," *Science Express*, Mar. 27, 2008, 10.1126/science.1154367;

Ko et al., "A Hemispherical Electronic Eye Camera Based on Compressible Silicon Optoelectronics," *Nature*, Aug. 7, 2008, vol. 454, pp. 748-753;

Kim et al., "Complementary Metal Oxide Silicon Integrated Circuits Incorporating Monolithically Integrated Stretchable Wavy Interconnects," *Applied Physics Letters*, Jul. 31, 2008, vol. 93, 044102;

Kim et al., "Materials and Noncoplanar Mesh Designs for Integrated Circuits with Linear Elastic Responses to Extreme Mechanical Deformations," *PNAS*, Dec. 2, 2008, vol. 105, no. 48, pp. 18675-18680;

Meitl et al., "Transfer Printing by Kinetic Control of Adhesion to an Elastomeric Stamp," *Nature Materials*, January, 2006, vol. 5, pp. 33-38;

U.S. Patent Application publication no. 2010 0002402-A1, published Jan. 7, 2010, filed Mar. 5, 2009, and entitled "STRETCHABLE AND FOLDABLE ELECTRONIC DEVICES;"

U.S. Patent Application publication no. 2010 0087782-A1, published Apr. 8, 2010, filed Oct. 7, 2009, and entitled "CATHETER BALLOON HAVING STRETCHABLE INTEGRATED CIRCUITRY AND SENSOR ARRAY;"

U.S. Patent Application publication no. 2010 0116526-A1, published May 13, 2010, filed Nov. 12, 2009, and entitled "EXTREMELY STRETCHABLE ELECTRONICS;"

U.S. Patent Application publication no. 2010 0178722-A1, published Jul. 15, 2010, filed Jan. 12, 2010, and entitled "METHODS AND APPLICATIONS OF NON-PLANAR IMAGING ARRAYS;" and

U.S. Patent Application publication no. 2010 027119-A1, published Oct. 28, 2010, filed Nov. 24, 2009, and entitled "SYSTEMS, DEVICES, AND METHODS UTILIZING STRETCHABLE ELECTRONICS TO MEASURE TIRE OR ROAD SURFACE CONDITIONS."

Kim, D. H. et al. (2010). Dissolvable films of silk fibroin for ultrathin conformal bio-integrated electronics. *Nature Materials*, 9, 511-517.

Omenetto, F. G. and D. L. Kaplan. (2008). A new route for silk. *Nature Photonics*, 2, 641-643.

Omenetto, F. G., Kaplan, D. L. (2010). New opportunities for an ancient material. *Science*, 329, 528-531.

Halsed, W. S. (1913). Ligature and suture material. *Journal of the American Medical Association*, 60, 1119-1126.

Masuhiro, T., Yoko, G., Masaobu, N., et al. (1994). Structural changes of silk fibroin membranes induced by immersion in methanol aqueous solutions. *Journal of Polymer Science*, 5, 961-968.

Lawrence, B. D., Cronin-Golomb, M., Georgakoudi, I., et al. (2008). Bioactive silk protein biomaterial systems for optical devices. *Biomacromolecules*, 9, 1214-1220.

Demura, M., Asakura, T. (1989). Immobilization of glucose oxidase with *Bombyx mori* silk fibroin by only stretching treatment and its application to glucose sensor. *Biotechnology and Bioengineering*, 33, 598-603.

Wang, X., Zhang, X., Castellot, J. et al. (2008). Controlled release from multilayer silk biomaterial coatings to modulate vascular cell responses. *Biomaterials*, 29, 894-903.

U.S. patent application Ser. No. 12/723,475 entitled "SYSTEMS, METHODS, AND DEVICES FOR SENSING AND TREATMENT HAVING STRETCHABLE INTEGRATED CIRCUITRY," filed Mar. 12, 2010.

U.S. patent application Ser. No. 12/686,076 entitled "Methods and Applications of Non-Planar Imaging Arrays," filed Jan. 12, 2010.

U.S. patent application Ser. No. 12/636,071 entitled "Systems, Methods, and Devices Using Stretchable or Flexible Electronics for Medical Applications," filed Dec. 11, 2009.

U.S. Patent Application publication no 2012-0065937-A1, published Mar. 15, 2012, and entitled "METHODS AND APPARATUS FOR MEASURING TECHNICAL PARAMETERS OF EQUIPMENT, TOOLS AND COMPONENTS VIA CONFORMAL ELECTRONICS."

U.S. patent application Ser. No. 12/616,922 entitled "Extremely Stretchable Electronics," filed Nov. 12, 2009.

U.S. patent application Ser. No. 12/575,008 entitled "Catheter Balloon Having Stretchable Integrated Circuitry and Sensor Array," filed on Oct. 7, 2009.

U.S. patent application Ser. No. 13/336,518 entitled "Systems, Methods, and Devices Having Stretchable Integrated Circuitry for Sensing and Delivering Therapy," filed Dec. 23, 2011.

It should be appreciated that all combinations of the foregoing concepts and additional concepts described in greater detail below (provided such concepts are not mutually inconsistent) are contemplated as being part of the inventive subject matter disclosed herein. It also should be appreciated that terminology explicitly employed herein that also may appear in any disclosure incorporated by reference

should be accorded a meaning most consistent with the particular concepts disclosed herein.

BRIEF DESCRIPTION OF THE DRAWINGS

The skilled artisan will understand that the figures, described herein, are for illustration purposes only, and that the drawings are not intended to limit the scope of the disclosed teachings in any way. In some instances, various aspects or features may be shown exaggerated or enlarged to facilitate an understanding of the inventive concepts disclosed herein (the drawings are not necessarily to scale, emphasis instead being placed upon illustrating the principles of the teachings). In the drawings, like reference characters generally refer to like features, functionally similar and/or structurally similar elements throughout the various figures.

FIGS. 1A-1C show example voltage waveforms for stimulating nerves, according to the principles described herein.

FIG. 2 shows a plot of percent changes of renal blood flow as a function of integrated voltage being delivered during pacing, according to the principles described herein.

FIG. 3A shows an example device that can be used to perform a procedure, according to the principles described herein.

FIG. 3B shows an example flow sensor, according to the principles described herein.

FIGS. 4A and 4B show example implementation of an example device, according to the principles described herein.

FIG. 5 shows an example implementation of an electronic circuit and flow sensor, according to the principles described herein.

FIGS. 6A-6D show example flow sensors or example heating elements, according to the principles described herein.

FIG. 7A shows another example device, according to the principles described herein.

FIG. 7B shows another example device, according to the principles described herein.

FIGS. 8A and 8B illustrate an operation of the example flow sensors of FIG. 7A-7B, according to the principles described herein.

FIG. 9 shows an example simplified schematic of a differential pre-amplifier, according to the principles described herein.

FIG. 10 shows an example operation of a 3- ω acquisition system, according to the principles described herein.

FIG. 11 illustrates an operation of an example flow sensor, according to the principles described herein.

FIG. 12 shows an example block diagram of an example PID controller coupled to an example flow sensor, according to the principles described herein.

FIG. 13 shows an example of synchronous demodulation, according to the principles described herein.

FIGS. 14A-14C show cross-sectional layering structure of various components of an example device, according to the principles described herein.

FIG. 15 shows a flowchart of an example method for performing an example assessment, according to the principles described herein.

FIG. 16 shows example plots of flow measurements, according to the principles described herein.

FIG. 17 shows a block diagram of an example system including an assessment module according to the principles described herein.

FIG. 18A shows an example flow sensor, according to the principles described herein.

FIG. 18B shows example measurements using an example flow sensor, according to the principles described herein.

FIG. 19 shows an example method for performing a procedure, according to the principles described herein.

FIG. 20 shows an example architecture of an illustrative computer system, according to the principles described herein.

FIGS. 21A and 21B show the results of example measurement using an example device, according to the principles described herein.

FIGS. 22A and 22B show the results of example use of an example device, according to the principles described herein.

FIGS. 23A-23G illustrates examples of multi-electrode and balloon catheter devices, according to the principles described herein.

FIGS. 24A-24D shows examples of catheter devices.

FIGS. 24E and 24F shows example forms of sensing, according to the principles described herein.

FIG. 25 shows a non-limiting example of flow sensors on catheters, according to the principles described herein.

FIG. 26 shows an example of flow sensors on a spiral-shaped catheter, according to the principles described herein.

FIG. 27 shows a catheter with bipolar electrodes and metal interconnects, according to the principles described herein.

FIG. 28A-28D shows example displays of data or analysis, according to the principles described herein.

FIG. 29 shows example displays of data and plots, according to the principles described herein.

DETAILED DESCRIPTION

Following below are more detailed descriptions of various concepts related to, and embodiments of, an apparatus and systems for embedding thinned chips in a flexible polymer. It should be appreciated that various concepts introduced above and described in greater detail below may be implemented in any of numerous ways, as the disclosed concepts are not limited to any particular manner of implementation. Examples of specific implementations and applications are provided primarily for illustrative purposes.

As used herein, the term “includes” means includes but is not limited to, the term “including” means including but not limited to. The term “based on” means based at least in part on. As used herein, the term “disposed on” or “disposed above” is defined to encompass “at least partially embedded in.”

With respect to substrates or other surfaces described herein in connection with various examples of the principles herein, any references to “top” surface and “bottom” surface are used primarily to indicate relative position, alignment and/or orientation of various elements/components with respect to the substrate and each other, and these terms do not necessarily indicate any particular frame of reference (e.g., a gravitational frame of reference). Thus, reference to a “bottom” of a substrate or a layer does not necessarily require that the indicated surface or layer be facing a ground surface. Similarly, terms such as “over,” “under,” “above,” “beneath” and the like do not necessarily indicate any particular frame of reference, such as a gravitational frame of reference, but rather are used primarily to indicate relative position, alignment and/or orientation of various elements/components with respect to the substrate (or other surface)

and each other. The terms “disposed on” “disposed in” and “disposed over” encompass the meaning of “embedded in,” including “partially embedded in.” In addition, reference to feature A being “disposed on,” “disposed between,” or “disposed over” feature B encompasses examples where feature A is in contact with feature B, as well as examples where other layers and/or other components are positioned between feature A and feature B.

Renal denervation therapy can be used to disrupt the renal nerve through ablation, including through applying energy in the form of RF energy, heating, or cryo (extreme cold) to the nerves. This can be done by inserting a tube or catheter into the groin and guiding the device into the renal artery. The renal denervation procedure ordinarily is not configured to provide measurement of the efficacy of the process.

Other non-limiting examples of ablation energy that can be applied using a catheter with flow sensing according to the principles described herein include radiofrequency (RF), ultrasound energy, cryoablation, drug-based ablation, alcohol injection, microwave energy ablation, and light-based ablation (laser energy).

While the description of the assessment is described relative to a procedure on a renal artery, the assessment of the efficacy of a procedure can be performed in other systems. For example, an assessment described herein for determining the efficacy of a procedure using flow measurements can be applied to procedures being performed in other tissue lumen, such as pulmonary veins, coronary arteries, peripheral blood vessels, cardiac lumen, and any other lumen in which flow can be assessed.

Denervation therapy can be used to disrupt the nerve through ablation, including through applying energy in any of the forms described herein (such as applying RF energy, heating, or cryo (extreme cold) to the nerves), in other systems such as but not limited to the carotid sinus, the carotid body, the vagal nerve, the pulmonary artery, the celiac ganglion, or the bladder trigone.

An increase in blood flow in the renal artery can be used as an indicator of the degree of efficacy of a renal sympathetic denervation (RSDN) procedure. For example, an indication of an increase in the rate of blood flow can be considered an indicator that a RSDN procedure is effective in achieving the desired degree and/or amount of denervation in the tissue being targeted. Such an indication of the degree of efficacy can be extrapolated to signal an endpoint to the procedure if the flow-rate of blood is approaching the desired level. As another example, an indication of little or no change in the rate of blood flow can be considered an indicator that a RSDN procedure is ineffective or marginally effective in achieving the desired degree and/or amount of denervation in the tissue being targeted. Such an indication of the degree of efficacy can be extrapolated used in a determination of an expected number of additional procedures to be performed to achieve the desired outcome, or potential changes that could be made to make the RSDN procedure more effective.

According to the principles described herein, example devices and methods are described for determining the efficacy of a denervation procedure, or a pacing or other stimulation procedure. Example methods are disclosed that relate to monitoring changes in blood flow rates, or other fluid flow rates, before and/or after the denervation or pacing (or other stimulation) procedure to monitor the stage of the procedure or to determine an endpoint for performance of the procedure.

This disclosure relates to flow measurement systems that can be implemented to determine the efficacy of interven-

tional procedures, including denervation procedures such as but not limited to renal denervation or pacing (or other stimulation) procedures. According to an example and method described herein, a change in flow rate of blood through the tissue lumen can be used to provide an indication of the effectiveness of a procedure performed on the tissue (such as but not limited to the renal artery). The procedure can be any procedure to disrupt the nerve, e.g., through ablation, including through applying energy in the form of RF energy, heating, or cryo (extreme cold) to the nerves. An example application of a flow measurement system, apparatus and method described herein is to provide an indication to a physician that the clinical procedure is successful.

According to the principles described herein, example devices and methods are described for use in establishing a clinical endpoint in a procedure in a renal artery or other tissue. In an example system and method, a measure of blood flow in a renal artery or other tissue prior to the procedure and/or subsequent to the procedure can be used to provide an indication of an efficacy of a procedure. In another example, blood flow measurements during a pre-procedure cycle and/or during a post-procedure cycle can be used to establish a clinical endpoint for the procedure being performed to disrupt the nerve, e.g., through ablation, including through applying energy in the form of RF energy, heating, or cryo (extreme cold) to the nerves.

Sympathetic nerve activity controls blood pressure and flow by virtue of vasoconstriction. Delivery of electrical stimulation to sympathetic nerves can, in turn, be used to stimulate the nerves and cause a modulation in blood flow or other fluid flow. According to the principles described herein, example devices and methods are described for measuring changes in local blood flow and/or pressure during a procedure, such as but not limited to a RSDN procedure.

At present, most forms of high-performance electronics and electrodes are rigid, bulky and have cylindrical cuff-like formats that are inherently low density and incompatible with the soft, complex topologies of arteries. In various example implementations, novel multifunctional catheter devices are described that include novel microfabrication technology to build arrays of soft and flexible nanomembrane flow sensing and electrode elements that can be used to provide feedback about renal blood flow, while concurrently delivering pacing energy and/or ablation energy. In various examples described herein, novel design strategies and fabrication techniques are described that use inorganic semiconductor processes to achieve high performance flexible flow sensor and electrode arrays on catheter devices, such as but not limited to, spiral shaped and balloon catheters that concurrently measure flow and apply RF energy and pacing energy inside a renal artery.

An example catheter device according to the principles described herein can include at least one pacing electrode. In a pacing procedure, a potential is applied to a portion of tissue proximate to a nerve to stimulate blood flow. FIGS. 1A-1C show example voltage waveforms that can be used to stimulate the nerves. FIG. 2 shows a plot of percent changes of renal blood flow as a function of integrated voltage being delivered during pacing. FIGS. 1A-1C and FIG. 2 demonstrate that blood flow can be changed in the renal artery due to programmed nerve stimulation (during pacing). In an example, such pacing can be performed during a procedure performed according to the principles described herein. For example, at least one pacing electrode can be disposed on an example catheter device described herein to provide an

electrical stimulation to tissue, e.g., in a region of a nerve source, prior to, during, and/or following a procedure. That procedure can be any procedure that disrupts the renal nerve through ablation, including through applying energy in the form of RF energy, heating, or cryo (extreme cold) to the nerves.

Example devices and methods are described that combine, on a single catheter device, components to perform a procedure on a tissue and components to perform sensing of the flow rate of blood, according to the principles described herein. Example devices and methods are also described that combine on a single catheter device, components to perform nerve stimulation (such as using pacing electrodes) and components to perform sensing of the flow rate of blood, according to the principles described herein. In an example, an indication of the flow rate of blood based on measurements using the catheter device can be used to establish a clinical endpoint during a procedure, including a RSDN procedure.

FIG. 3A shows an example device **300** that can be used to perform a procedure according to the principles described herein. The example device **300** includes an inflatable and/or expandable body **302**, a flow sensor **304** disposed on a portion of the inflatable and/or expandable body **302**, and an electronic circuit **306** disposed on the inflatable and/or expandable body **302**. The electronic circuit **306** includes a number of components that accommodate expanding of the inflatable and/or expandable body **302**. In FIG. 3A, the flow sensor **304** is illustrated as being disposed on a distal portion of the inflatable body. In another example, the flow sensor can be disposed on or proximate to a proximal portion of the inflatable and/or expandable body.

In an example implementation, the flow sensor can be a formed as illustrated in FIG. 3B. FIG. 3B shows an example flow sensor **306'** that includes a heating element **307** disposed proximate to a temperature sensor **308**. The heating element **307** and temperature sensor **308** may be disposed on, or encapsulated in, a support **309**. Support **309** can be formed from a thermally conductive material. In various examples, the heating element **307** can be separated from the temperature sensor **308** by a separation "x". The parameter "x" can be about 1 mm, about 2 mm, about 3 mm, about 5 mm, about 8 mm, about 10 mm, about 12 mm, about 18 mm, about 24 mm, about 30 mm or more. Temperature sensor **308** can be a thermocouple, a resistance temperature detector (RTD) temperature sensor, a junction potential temperature sensor (including sensors that use a voltage measure across a junction as an indicator of temperature), a thermistor, an integrated-circuit temperature sensor (including a LM35-series temperature sensor), or a semiconductor temperature sensor. Example flow sensor **306'** can provide a measure of the flow rate of blood in a tissue lumen based on temperature measurements of the temperature sensor. In operation, the heating element is used to maintain the temperature sensor at a specified temperature measurement value. Any fluid flowing past the heating element and temperature sensor can cause some change or fluctuation in the temperature measurement of the temperature sensor. The heating element is configured such that it tried to maintain the temperature sensor at the stable specified temperature reading. A change in the fluid flow rate that causes some fluctuation in the reading of the temperature sensor causes the heating element to increase or decrease its heat output to bring the temperature sensor to its specified reading. A faster flow rate of the fluid (e.g., the blood) in the region of the flow sensor can cause the heating element to increase its heat output. A slower flow rate of the fluid (e.g., the blood) in the region of

the flow sensor can cause the heating element to decrease its heat output. As a result, a change in the operating point of the heating element can be used to provide an indication of the flow rate of the fluid measurement of the temperature sensor can be used to provide an indication of the flow rate of fluid proximate to the inflatable and/or expandable body **302**.

As shown in FIG. 3B, the support **309** can be configured to separate the heating element **307** from the fluid by a value "y" as shown in FIG. 3B. The parameter "y" can be about 2 mm, about 3 mm, about 5 mm, about 8 mm, about 10 mm, about 12 mm, about 15 mm or more. For different example implementations, parameters "x" and "y" can be modified to vary the dynamic range of the resulting example flow sensor. For example, "x" can be made larger and "y" can be made smaller to increase the overall range of the example flow sensor. For smaller values of "y", the heat is able to flow to the region fluid more easily. With larger values of "x", it could take more power to generate enough heat to flow to the position of the temperature sensor "x" to bring the temperature sensor to a desired specified measurement setpoint. As a result, the flow sensor can be operated over a greater overall range, including range of the operation signal to the heating element. For example, as described hereinbelow, the level/magnitude of the signal to the heating element can be used to provide an indication of the flow rate of the fluid. The greater range of the operation signal to the heating element according to this principle can provide a larger range of values and a larger data asset of values for use in determining the fluid flow rate. In an example implementation, the system can include a plurality of flow sensors, with two or more of the flow sensors configured with differing values of "x" and "y" between the heating element and temperature sensor of the respective flow sensor. As a result, the example system presents flow sensors displaying a variety of measurement ranges.

The example flow sensors according to the principles described herein can include a temperature sensor proximate to a thermal 'radiation' source. According to any of the example systems, methods and apparatus described herein, non-limiting examples of heating elements that can provide the thermal radiation include any form of heater that can be coupled with a catheter, including a resistive heater or a thermoelectric heater.

In any example device according to the principles described herein, the temperature sensor can include at least one of a resistance temperature detector (RTD) temperature sensor, a thermocouple, a junction potential temperature sensor (including sensors that use a voltage measure across a junction as an indicator of temperature), a thermistor, an integrated-circuit temperature sensor (including a LM35-series temperature sensor), and a semiconductor temperature sensor. In various examples, a sensor of known impedance is used. Other non-limiting examples of sensors that can be used according to any of the systems and methods described herein include vapor deposited gold resistors and ceramic thermistors. In another example, other materials such as foils can be used.

In an example, a calibration standard can be developed for the flow sensor **306'**, to correlate the operating point of the heating element to a flow rate. For example, training samples can be used to convert a flow measurement, each training sample being a fluid caused to flow at a specific flow rate. For a given amount and/or rate of change of operating point of the heating element by the heating element, the operating point of the flow sensor is obtained for each training sample. The flow rate of each training sample is

known (given that it is pre-set for the training samples). The amount and/or rate of heating supplied by the heating element is also known. The calibration standard can be developed to correlate the known heating supplied to the known flow rate to obtain calibration data. The example calibration standard can be used to convert a flow sensor measurement to a flow rate for a fluid having similar properties as the fluid used in the training standard.

In an example implementation, the examples device of FIGS. 3A and 3B can further include a flow sensor that is disposed on a portion of a catheter that is coupled to the proximal portion of the inflatable and/or expandable body.

In an example, the electronic circuit 306 can include a number of electrodes disposed on the inflatable and/or expandable body 302. The electrodes can be used to perform a procedure according to the principles described herein. For example, at least one of the electrodes can be a radiofrequency (RF) electrode that delivers RF energy to a portion of the tissue surface that is proximate to the RF electrode. According to the principles described herein, the delivered RF energy is used to modify the tissue, including to disrupt a renal nerve.

In another example, the device 300 can include components to perform a procedure using other modalities. For example, the device 300 can include components to disrupt the renal nerve, e.g., through ablation, including through applying energy in the form of RF energy, heating, or cryo (extreme cold) to the nerves.

In another example, the electronic circuit 306 of device 300 can include at least one pacing electrode. The pacing electrode can be implemented to deliver an electrical stimulation to a portion of a tissue (such as but not limited to a renal artery) proximate to the pacing electrode. As described above, the pacing electrode can be used to stimulate nerve at different stages of a procedure. For example, the electrical stimulation from the pacing electrode(s) can be applied to the portion of the tissue to stimulate nerves prior to delivery of an energy to disrupt the nerves, such as but not limited to through ablation, including through applying energy in the form of RF energy, heating, or cryo (extreme cold) to the nerves. In another example, the electrical stimulation from the pacing electrode(s) can be applied to the portion of the tissue to stimulate nerves subsequent to delivery of an energy to disrupt the nerves, such as but not limited to through ablation, including through applying energy in the form of RF energy, heating, or cryo (extreme cold) to the nerves.

In another example, the electronic circuit 306 can also include temperature sensors, each temperature being disposed proximate to an electrode of the electronic circuit 306.

In another example, the device 300 can include one or more other components disposed on the inflatable and/or expandable body such as, but not limited to, a pacing electrode, a light-emitting device, a contact sensor, an image detector, a pressure sensor, a biological activity sensors, a temperature sensor, or any combination thereof.

FIGS. 4A and 4B show a non-limiting example implementation of an example device 400. The example device 400 includes an inflatable and/or expandable body 402, a flow sensor 404 disposed on a portion of the inflatable and/or expandable body 402, and an electronic circuit 406 disposed on the inflatable and/or expandable body 402. The electronic circuit 406 includes a number of components that accommodate expanding of the inflatable and/or expandable body 402. As shown in FIGS. 4A and 4B, the flow sensor 404 can be being disposed on a distal portion of the inflatable and/or expandable body 402. As a non-limiting example, a portion

of the distal region of the expandable and/or inflatable structure can be extended to form a protrusion. The flow sensor 404 can be mounted on the protrusion. In another example, the flow sensor 404 can be disposed on or proximate to a proximal portion of the inflatable and/or expandable body.

In an example implementation, the flow sensor 404 can be a formed as including a heating element 407 disposed proximate to a temperature sensor 408. In various examples, the heating element 407 can be separated from the temperature sensor 408 by about 1 mm or about 2 mm. As a non-limiting example, the heating element 407 can be a temperature-controlled heating element. As a non-limiting example, the temperature sensor 408 can be a thermistor.

In the non-limiting example of FIGS. 4A and 4B, the electronic circuit can include a number of electrodes 410 disposed on the inflatable and/or expandable body 402. The electrodes can be used to perform a procedure according to the principles described herein. For example, at least one of the electrodes 410 can be a radiofrequency (RF) electrode that delivers RF energy to a portion of the tissue surface that is proximate to the RF electrode. According to the principles described herein, the delivered RF energy is used to modify the tissue, including to disrupt a renal nerve.

As shown in the non-limiting example of FIGS. 4A and 4B, the electronic circuit 406 of the example device 400 can include stretchable interconnects 412 disposed on the surface of the inflatable and/or expandable body 402. As shown in FIG. 4B, the stretchable interconnects can be used to electrically couple at least one of the plurality of electrodes 410 to an external circuit.

As shown in the non-limiting example of FIGS. 4A and 4B, the electronic circuit 406 of the example device 400 can also include a main bus 414. As shown in FIG. 4B, the stretchable interconnects 412 electrically couple the electrodes 410 to the main bus 414. As also shown in FIG. 4B, the main bus 414 can extend beyond the inflatable and/or expandable body 402 to facilitate electrical coupling of the electrodes 410 to an external circuit.

In another example, the at least one of the electrodes 410 of electronic circuit 406 of device 400 can be a pacing electrode. The pacing electrode can be implemented to deliver an electrical stimulation to a portion of a tissue (such as but not limited to a renal artery) proximate to the pacing electrode. As described above, the pacing electrode can be used to stimulate nerve at different stages of a procedure. For example, the electrical stimulation from the pacing electrode(s) can be applied to the portion of the tissue to stimulate nerves prior to delivery of an energy to disrupt the nerves, such as but not limited to through ablation, including through applying energy in the form of RF energy, heating, or cryo (extreme cold) to the nerves. In another example, the electrical stimulation from the pacing electrode(s) can be applied to the portion of the tissue to stimulate nerves subsequent to delivery of an energy to disrupt the nerves, such as but not limited to through ablation, including through applying energy in the form of RF energy, heating, or cryo (extreme cold) to the nerves.

In another example, the device 400 can include components to perform a procedure using other modalities. For example, the device 400 can include components to disrupt the renal nerve, e.g., through ablation, including through applying energy in the form of RF energy, heating, or cryo (extreme cold) to the nerves.

In another example, the device 400 can include one or more other components disposed on the inflatable and/or expandable body such as, but not limited to, a pacing

electrode, a light-emitting device, a contact sensor, an image detector, a pressure sensor, a biological activity sensors, a temperature sensor, or any combination thereof.

In another example, the device 400 can also include temperature sensors, each temperature being disposed proximate to an electrode 410 of the electronic circuit 406.

FIG. 5 shows a non-limiting example implementation of an electronic circuit 506 and flow sensor 504 that can be disposed on a catheter and extend to a shaft of an example device according to the principles described herein. The electronic circuit 506 includes a number of electrodes 510. In various examples, the electrodes 510 can be conformable electrodes that conform to the surface of the inflatable and/or expandable body. As shown in FIG. 5, the flow sensor 504 includes a heating element 507 disposed proximate to a temperature sensor 808. As a non-limiting example, the heating element 507 can be a temperature-controlled heating element. As a non-limiting example, the temperature sensor 508 can be a thermistor.

In the non-limiting example of FIG. 5, at least one of the electrodes 510 can be a radiofrequency (RF) electrode that delivers RF energy to a portion of the tissue surface that is proximate to the RF electrode. According to the principles described herein, the delivered RF energy is used to modify the tissue, including to disrupt a renal nerve. At least one of the electrodes 510 can be a pacing electrode that delivers an electrical stimulation to a nerve, as described herein.

As shown in the non-limiting example of FIG. 5, the electronic circuit 506 includes stretchable interconnects 512 disposed on the surface of the inflatable and/or expandable body. The stretchable interconnects 512 can be used to electrically couple at least one of the plurality of electrodes 510 to an external circuit.

As also shown in the non-limiting example of FIG. 5, the electronic circuit 506 also includes a main bus 514. As shown in FIG. 5, the stretchable interconnects 512 electrically couple the electrodes 510 to the main bus 514. As also shown in FIG. 5, the main bus 514 includes connection pads 516 that facilitate electrical coupling of the electrodes 510 to an external circuit.

FIG. 6A shows a portion of an example device 600 that can be used to perform a procedure according to the principles described herein. The example device 300 includes an elongated member 602, and a flow sensor 604 disposed on a distal portion of the elongated member 602. In FIG. 6A, the flow sensor 604 is illustrated as being disposed on a distal portion of the elongated member. In another example, the flow sensor can be disposed on or proximate to a proximal portion of the elongated member or on a proximal or distal portion of an inflatable and/or expandable body that is coupled to the elongated member.

In this example implementation, the flow sensor can be formed as illustrated in FIG. 6A, and includes a heating element 606 and a temperature sensor 608. The heating element 606 includes a cavity 607. As shown in FIG. 6A, at least a portion of the temperature sensor 608 is housed in a portion of the cavity 607. Similarly to as described in connection with the flow sensor of FIGS. 3A and 3B above, the heating element 606 can be used to heat an area proximate to the elongated member 602. A temperature measurement of the temperature sensor 608 can be used to provide an indication of the flow rate of a fluid proximate to the flow sensor 604. For example, if the fluid has a higher flow rate and wicks away heat from the area proximate to the heating element, the temperature sensor can record a different measurement than obtained if the fluid flow rate is lower.

In operation, the heating element is used to maintain the temperature sensor at a specified temperature measurement value. Any fluid flowing past the heating element and temperature sensor can cause some change or fluctuation in the temperature measurement of the temperature sensor. The heating element is configured such that it tries to maintain the temperature sensor at the stable specified temperature reading. A change in the fluid flow rate that causes some fluctuation in the reading of the temperature sensor causes the heating element to increase or decrease its heat output to bring the temperature sensor to its specified reading. A faster flow rate of the fluid (e.g., the blood) in the region of the flow sensor can cause the heating element to increase its heat output. A slower flow rate of the fluid (e.g., the blood) in the region of the flow sensor can cause the heating element to decrease its heat output. As a result, a change in the operating point of the heating element can be used to provide an indication of the flow rate of the fluid measurement of the temperature sensor can be used to provide an indication of the flow rate of fluid proximate to the inflatable and/or expandable body 302.

As also described above in connection with the flow sensor of FIGS. 3A and 3B, temperature sensor 608 can be a thermocouple, a resistance temperature detector (RTD) temperature sensor, a junction potential temperature sensor (including sensors that use a voltage measure across a junction as an indicator of temperature), a thermistor, an integrated-circuit temperature sensor (including a LM35-series temperature sensor), or a semiconductor temperature sensor. In various examples, a sensor of known impedance is used. Other non-limiting examples of sensors that can be used according to any of the systems and methods described herein include vapor deposited gold resistors and ceramic thermistors. In another example, other materials such as foils can be used.

The example flow sensors according to the principles described in connection with FIG. 6A can include any type of a thermal 'radiation' source. Non-limiting examples of heating elements that can be implemented to provide the thermal radiation include any form of heater that can be coupled with an elongated member and be configured to have a cavity. As non-limiting examples, the heating element can be, but is not limited to, a resistive heater or a thermoelectric heater.

FIG. 6B shows an implementation 620 of an example flow sensor 624 according to the principles of FIG. 6A. The example flow sensor 624 includes a heating element 626 and a temperature sensor 628. The heating element 626 is formed as a spiral, helical, or other coiled resistive wire with a hollow core that provides a cavity. The resistive wire can be formed from a high resistivity electrically material to facilitate higher power dissipation. As shown in FIG. 6A, at least a portion of the temperature sensor 628 is housed in a portion of the cavity. As shown in this example, the heating element 626 and the temperature sensor 628 can be at least partially encapsulated in a thermally conductive encapsulant. Similarly to as described in connection with the flow sensor of FIGS. 3A and 3B above, the heating element 626 can be used to heat an area proximate to an elongated member that the flow sensor is coupled to. A temperature measurement of the temperature sensor 628 can be used to provide an indication of the flow rate of a fluid proximate to the flow sensor 624.

FIG. 6C shows another implementation 630 of an example flow sensor according to the principles of FIG. 6A. The example flow sensor includes a heating element 636 and a temperature sensor (not shown). The heating element 636

is formed as a patterned thin-film of a resistive material **631** on a flexible and/or stretchable substrate **633**. In this example, the thin-film is patterned in a boustrophedonic pattern. The heating element **636** can be rolled into a more compact form factor, with at least a portion formed with a hollow core that provides a cavity. The resistive wire can be formed from a high resistivity electrically conductive material to facilitate higher power dissipation. Similarly to as described in connection with the flow sensor of FIGS. **3A** and **3B** above, the heating element **636** can be used to heat an area proximate to an elongated member that the flow sensor is coupled to. A temperature measurement of the temperature sensor disposed at least partially in the cavity can be used to provide an indication of the flow rate of a fluid proximate to the flow sensor **634**.

FIG. **6C** shows another implementation **630** of an example flow sensor according to the principles of FIG. **6A**. The example flow sensor includes a heating element **636** and a temperature sensor (not shown). The heating element **636** is formed as a patterned thin-film of a resistive material **631** on a flexible and/or stretchable substrate **633**. In this example, the thin-film is patterned in a boustrophedonic pattern. In another example, other linear patterns can be used. The heating element **636** can be formed into a compact form factor, with at least a portion formed with a cavity **637**. The thin-film can be formed from a high resistivity electrically conductive material to facilitate higher power dissipation. Similarly to as described in connection with the flow sensor of FIGS. **3A** and **3B** above, the heating element **636** can be used to heat an area proximate to an elongated member that the flow sensor is coupled to. A temperature measurement of the temperature sensor disposed at least partially in the cavity can be used to provide an indication of the flow rate of a fluid proximate to the flow sensor.

FIG. **6D** shows another implementation **640** of an example flow sensor coupled to a portion of an elongated member **642** according to the principles of FIG. **6A**. The example flow sensor includes a heating element **646** and a temperature sensor (not shown). The heating element **646** is formed as a patterned thin-film of a resistive material **641** on a flexible and/or stretchable substrate **643**. As shown in this example, the thin-film can be patterned in a stretchable pattern. The stretchable pattern allows more bending of the elongated member while compensating for surface strain. While the example of FIG. **6D** shows a serpentine pattern, the stretchable pattern may be other stretchable pattern, including a zig-zag pattern, a wavy pattern or a rippled pattern. The heating element **646** can be formed into a compact form factor, with at least a portion formed with a cavity. The thin-film can be formed from a high resistivity electrically conductive material to facilitate higher power dissipation. Similarly to as described in connection with the flow sensor of FIGS. **3A** and **3B** above, the heating element **646** can be used to heat an area proximate to an elongated member that the flow sensor is coupled to. A temperature measurement of the temperature sensor disposed at least partially in the cavity can be used to provide an indication of the flow rate of a fluid proximate to the flow sensor.

FIG. **7A** shows another example device **700** that can be used to perform a procedure according to the principles described herein. The example device **700** includes an inflatable and/or expandable body **702**, a pair of flow sensors **704-a** and **704-b**, and an electronic circuit **706** disposed on the inflatable and/or expandable body **702**. The device **700** is coupled to a distal portion of a shaft **708**. The electronic circuit **706** includes a number of components that accommodate expanding of the inflatable and/or expandable body

702. In FIG. **7A**, one of the flow sensor **704-a** is shown to be disposed on a proximal portion of the inflatable body. The other flow sensor (reference flow sensor **704-b**) is shown to be disposed on a portion of shaft **708** at some distance away from the inflatable and/or expandable body **702**. In the example implementation of FIG. **7A**, the flow rate can be measured based on comparison of the measurement of the pair of flow sensors **706-a** and **706-b**. For example, the flow rate can be measured based on comparison of voltage measurements of the pair of flow sensors **706-a** and **706-b**.

FIG. **7B** shows another example device **700'** that can be used to perform a procedure according to the principles described herein. Example device **700'** includes an inflatable and/or expandable body **702**, a pair of flow sensors **704-a** and **704-b**, an electronic circuit **706** disposed on the inflatable and/or expandable body **702**, and a shaft **708**, the same components as example device **700**, and they are not repeated. Example device **700'** also includes a shaft **710** that can be disposed over reference electrode **704-b** during a procedure or a flow measurement. The example device **710** also can be retracted to such an extent that reference flow sensor **704-b** is exposed.

In the various examples described herein, the reference sensor can be positioned on the shaft at a location that can be covered by a sheath. FIG. **7B** shows a non-limiting example of a catheter device that includes a sheath member that can be positioned to cover at least a portion of the reference sensor. In an example implementation, this distance can be determined as greater than or equal to about 10 cm away from the proximal end of the balloon. In another example implementation, this distance can be determined as less than about 10 cm away from the proximal end of the balloon. For example, the reference flow sensor **704-b** can be positioned at a distance away from the shaft of the catheter that is at least about 5 cm, at least about 8 cm, at least about 10 cm, at least about 13 cm, at least about 15 cm or more. In an example implementation, a sheath can be included and used to guide, introduce and steer the catheter. The sheath can be a member that surrounds at least a portion of the circumference of the shaft of the catheter and/or can be co-axial with the shaft of the catheter. During a procedure, the reference sensor can be maintained under the sheath. The sheath can be configured to provide a stable known environment and provide a chamber that can include blood in the absence of flow. In this example, blood enters the sheath but flow can be halted by the presence of a stopcock or flow switch. The blood can be maintained at body temperature but does not flow, thereby providing a useful comparison in proximity of the reference sensors. The measurement performed using the reference sensor in this environment of blood that is not flowing can serve as a reference for comparison to the renal artery sensor.

The internal shaft near the reference sensor can include surface features in the form of bumps or tracks that provide channels for the blood. The blood forms an insulating layer on the reference sensor, allowing a reference quiescent blood temperature to be measured. The surface features can be designed and configured to allow blood to circulate as freely and prevent the shaft from making contact with the sheath in that area. For example, the shaft may include one or more spacers (also referred to as protuberances) to maintain the shaft spaced apart from a portion of the surface of the sheath. The spacing apart of the shaft from the sheath helps to maintain a static layer of blood static between the sheath and the shaft.

FIGS. **8A** and **8B** illustrate an operation of the flow sensors of FIG. **7A-7B**. FIG. **8A** shows an example device

800 that includes an inflatable and/or expandable body 802, a pair of flow sensors 804-a and 804-b, an electronic circuit 806 disposed on the inflatable and/or expandable body 802, a shaft 808 and a sheath 810. Flow sensor 804-b is coupled to the shaft and covered by the sheath 810. In the example of FIG. 8B, blood flows in the aorta and renal artery, yet blood remains static in the sheath due to a stopcock or flow switch. This allows a differential measurement of flow in the renal artery versus static flow in the sheath. It also allows for better use of dynamic range since the measurement is limited between the two sensors. As also shown in FIG. 8B, the inflatable or expandable structure can be deflated or retracted at the time of flow sensor measurement.

In an example implementation, the method in connection with FIGS. 8A and 8B can be used to resolve small changes in temperature in the body. An example system, apparatus and method according to the principles described herein can be used to measure the signal of interest in connection with a procedure and reject information that does not relate to the signal of interest, thereby increasing resolution and reducing the requirements for expensive signal processing.

An example system, apparatus and method according to the principles described herein can be used to measure differential flow, such as described in connection with FIGS. 8A and 8B. In an example implementation, two (or more) sensors are used to measure flow via a change in flow sensor operating point. As shown in FIGS. 8A and 8B, at least one reference sensor can be placed on the shaft of a catheter used to perform a measurement described herein. The non-limiting example catheter can include one or more renal artery flow sensors and/or one or more other sensors, including one or more ablation components and/or one or more pacing electrodes. The reference sensor can be disposed about the inflatable or expandable member of the catheter, such as but not limited to a balloon, an expandable mesh, or a deployable netting. The reference sensor can be disposed at a sufficient separation distance away from the proximal end of the balloon so that the reference sensor is covered by the sheath of the catheter when it is proximate to the tissue of the body. One or more renal artery sensors can be positioned at or near the proximal end of the balloon. Each measurement taken can be compared or displayed in reference to a measurement of the reference sensor.

Systems, methods and apparatus are described herein that can be used to increase the dynamic range of measurements by focusing on the signal of interest. In an example implementation, each flow sensor, including any reference sensor, can be excited using the same controlled current source. In an example implementation, each sensor can be measured using an instrumentation amplifier. FIG. 9 shows a non-limiting example simplified schematic of a differential pre-amplifier that can be used to measure differences in voltages. The example differential pre-amplifier circuitry can be implemented to compare measurements of flow sensors according to the principles of FIGS. 8A-8B. In this non-limiting example, the flow sensors can include thermistors. In other examples, the flow sensors can include at least one of a resistance temperature detector (RTD) temperature sensor, a thermocouple, a junction potential temperature sensor (including sensors that use a voltage measure across a junction as an indicator of temperature), an integrated-circuit temperature sensor (including a LM35-series temperature sensor), and a semiconductor temperature sensor. In various examples, a sensor of known impedance is used. Other non-limiting examples of sensors that can be used according to any of the systems and methods described

herein include vapor deposited gold resistors and ceramic thermistors. In another example, other materials such as foils can be used.

In the example of FIG. 9, the difference in the voltage can be measured between the flow sensors (such as but not limited to the thermistor) that are driven by an excitation current. Signal C is the difference between the signal from the flow sensor proximate to the inflatable and/or expandable body (renal flow sensor measurement—signal A) and the signal from the reference flow sensor (reference flow sensor measurement—signal B).

The instrumentation amplifiers can be used to reject common-mode signals, thereby providing a higher fidelity signal. In a non-limiting example, an apparatus or system described herein can include thermistors that are well matched (used as the flow sensors in this example). The absolute values of the thermistor measurements can be used. A benefit of measuring a reference thermistor and renal artery thermistor can be improvement of the dynamic range by measuring the difference of the values between the sensors as compared to using the absolute values. Limiting the measurements between the reference and the renal artery sensor can facilitate improvement of the dynamic range of the measurements.

An example implementation to perform a measurement is described. In an example, the flow sensors are of known impedances, and application of an excitation current using the flow sensors creates a voltage that is measured using instrumentation amplifiers. The amplifiers are used to measure a voltage correlating to a flow rate. Changes in blood flow can result in a change in operating set point in at least one of the flow sensors. By comparing the value of voltage measured using the reference sensor to the value of voltage measured using a flow sensor disposed proximate to the expandable and/or inflatable body, the flow rate can be quantified. Through this comparison, the instrument voltage in the absence of flow also can be removed. In an example, the value of voltage measured using the reference sensor is subtracted from the renal artery sensor voltage to provide an indication of the instrument voltage in the absence of flow. In an example where a reference flow sensor is surrounded by a sheath, blood in the sheath is physically static. That is, it is not flowing and remains at body temperature. Blood in the renal artery is also at body temperature but flows at some rate (desired to be measured).

The differential voltage comparison can be computed based on the flow sensor measurement data as follows:

$$\text{Differential Measurement (C)} = \text{Renal Artery Sensor Voltage (A)} - \text{Reference Sensor Voltage (B)}$$

It also can be expressed as: $C = A - B$

Effectively, in an example implementation, the equation can be expressed as:

$$\text{Differential Measurement} = (\text{Voltage}_{\text{BodyTemp}} + \text{Voltage}_{\text{RenalFlow}}) - (\text{Voltage}_{\text{BodyTemp}} + 0)$$

where $V_{\text{SheathFlow}} = 0$.

$$\text{Differential Measurement} = \text{Voltage}_{\text{RenalFlow}}$$

A gain can be added at any of the instrumentation amplifiers to increase the amplitude of the signal.

In an example implementation, one or more flow sensors can be calibrated. An offset value between the flow sensors disposed proximate to the inflatable and/or expandable body and the reference flow sensor(s) can be eliminated by placing the catheter in a known temperature and flow rate, and measuring the difference between the two sets of sensors. The measurement can be performed and/or the offset

value can be derived at the time of manufacture of the catheter and/or time of assembly of the flow sensors with the inflatable and/or expandable body of the catheter. The offset value can be stored and/or indicated as a written value, or a barcode or other form of identification (ID). In an example, an integrated circuit or memory device or other means can be used to provide this value and ID to a console that is in communication with the catheter (including with the flow sensors disposed on or proximate to the inflatable and/or expandable body). This offset value can be programmed into the catheter. When the catheter is coupled with the console, the console can use the offset value to compensate for an offset in the measurements when calculating flow.

Detecting a change in reading of a thermistor, such as in an example of the implementation described in connection with FIGS. 7A-7B and 8, can provide an indication of the rate of fluid flow. Detecting flow rate change in the renal artery can require high-resolution measurement.

For example, the differential measurement described in connection with FIGS. 7A-7B and 8 can be used in conjunction with other methods, such as peak-to-peak measurements, synchronous-demodulation (lock-in), and three omega (3ω) methods. In different example implementations, the differential measurement can be used to measure peak-to-peak output, or it can be input into a lock-in amplifier or 3ω acquisition system as shown in FIG. 10. The 3ω method can be implemented using a micro-fabricated metal pattern acting as a resistive heater. An alternating current (AC) voltage signal energizes the resistive element at a frequency ω . The periodic heating generates oscillations in the electrical resistance of the metal line at a frequency of 2ω . In turn, this leads to a third harmonic (3ω) in the voltage signal. The third harmonic is used according to an example implementation to determine the magnitude of the temperature oscillations. The temperature oscillations can be used to provide an indication of the flow rate of a fluid. For example, the frequency dependence of these temperature oscillations can be used to derive the thermal properties of the specimen (e.g., the fluid). The data indicative of the thermal properties of the specimen can be used to derive data indicative of the flow rate of the fluid.

In any of the examples described herein, the flow sensor (including the 3-omega sensor) can be disposed on the example device such that the flow sensor is disposed within a mid-point of a tissue lumen when the example device is disposed within the lumen. The mid-point of the lumen in tissue (including the renal artery lumen) can be the location of maximum flow velocity). The central positioning of the flow sensor can facilitate more accurate measured of fluid flow rate by sampling the area of maximum flow.

FIG. 11 illustrates an example device that is comprised of a flow sensor 1154 disposed on a distal portion of a rod catheter or guidewire 1152, a reference temperature sensor 1156 disposed on a proximal portion of the rod catheter or guidewire 1152, and a sheath 1158. Reference temperature sensor 1156 is coupled to the shaft and may be covered by the sheath 1158 or may remain uncovered. In the example of FIG. 11, the system can be operated such that a specified difference can be maintained between the value of the temperature measurement of the reference temperature sensor 1156 and the value of the temperature measurement of the temperature sensor of the flow sensor 1154. As described in greater detail below, the temperature difference can be maintained at a value of temperature difference of about 1.5° C., about 2.0° C., about 2.5° C., about 3.0° C., about 3.5° C., about 4.0° C., or about 4.5° C. While the examples of FIGS. 7A through 8B are described as having a reference flow

sensor (704-b or 810), each system can be operated as described in connection with FIG. 11, but with the reference flow sensor replaced with a reference temperature sensor.

In an example implementation, a device according to any of the principles herein and in any of the figures, including FIGS. 3A through 8B or FIG. 11, can be implemented to performing a medical treatment procedure on a tissue as follows. The example device includes an elongated member, a flow sensor disposed proximate to a distal portion of the elongated member, and a reference temperature sensor disposed proximate to a proximal portion of the elongated member. The flow sensor and the reference temperature sensor are in communication with a control module. In this example, the control module is used to maintain a temperature difference between the measurement of the reference temperature sensor and the measurement of the temperature sensor of the flow sensor. For example, the control module can be used to monitor the temperature measurement(s) of the reference temperature sensor and/or the temperature measurement(s) of the temperature sensor of the flow sensor at various stages of the procedure being performed. Based on the monitoring, the control module can generate signals to the heating element to cause it to emit heat or discontinue emitting heat, such that that the temperature difference is maintained. The signal(s) applied to the heating element can be stored to a memory, transmitted using a communication interface or a communication protocol, and/or read out to a user interface (such as a display).

The temperature difference can be maintained as a constant temperature difference or a time-varying temperature difference. For example, a constant temperature difference can be maintained at about 1.5° C., about 2.0° C., about 2.5° C., about 3.0° C., about 3.5° C., about 4.0° C., or about 4.5° C.

In an example, the control module includes a proportional-integral-derivative (PID) controller. FIG. 12 shows an example control system for implementing a PID controller control loop. As shown in FIG. 11, the PID controller receives as input a voltage signal 1202 from the temperature sensor of the flow sensor and a voltage signal 1204 from the reference temperature sensor. At 1206, the PID controller applies an algorithm and associated method to determine the three-term controls: the proportional (P), the integral (I), and the derivative (D) values. Based on these computations, the PID controller determines the error or degree of deviation of the measured signals from the temperature sensors from the expected values that would maintain the desired temperature difference between them. The PID controller applies a heating element control algorithm (and associated method) to the combination of P, I, and D values to determine a signal to send to a voltage controlled current source 1210 to the heating element 1212. The signal sent to the voltage controlled current source 1210 causes adjustments to the power to the heating element, to cause it to emit heat, or discontinue emitting heat. That is, applying the PID controller involves comparing the value of the temperature measurement of the reference temperature sensor to the temperature measurement of the temperature sensor of the flow sensor, determining a signal, e.g., a PID correction signal, based on the comparison, and using the control module to determine the signal to the heating element based on the PID correction signal. As a result of the feedback from the temperature sensors to the PID controller, the system can minimize the deviation of the measured signals from the temperature sensors from the expected values that would maintain the desired temperature difference between them. In an

example, the system can include hardware to generate a sinusoidal current with a fixed frequency but varying amplitude for the heating element.

In an example implementation, the control module can be configured to maintain a constant temperature difference, such as but not limited to about 2° C., between the reference temperature sensor and the temperature measured at the temperature sensor of the flow sensor. For example, the heating element can be powered to heats the temperature sensor of the flow sensor (e.g., a thermistor) to about 39° C. The use of the control module as described herein maintains this temperature difference, such that the reference temperature sensor is maintained at a constant temperature difference of about 2° C., i.e., at about 37° C. The signal applied to the heating element can be stored to a memory, transmitted using a communication interface, and/or read out to a user interface (such as a display).

In another example implementation, the control module can be configured to maintain a constant temperature difference while the example device is being used during a procedure, e.g., nerve stimulation, ablation or other denervation procedure. If fluid flow rate increases during the procedure, the increased fluid flow rate removes heat from the region of the flow sensor (the coupled heating element and temperature sensor). The control module determines from the control loop that the temperature difference is deviating from the desired value (e.g., a temperature difference falling below about 2° C.). The control module generates a signal to cause the heating element to emit heat, to return the temperature difference to the desired value (e.g., a value of about 2° C.). The signal applied to the heating element can be stored to a memory, transmitted using a communication interface, and/or read out to a user interface (such as a display). In this case, the signal could show an increase, since as it sending controls to cause the heating element to emit heat.

In an example implementation where a stage of the procedure causes the fluid flow rate to decrease, the decreased fluid flow rate removes less heat from the region of the flow sensor (the coupled heating element and temperature sensor). The control module determines from the control loop that the temperature difference is deviating from the desired value (e.g., a temperature difference may be increasing to above about 2° C.). The control module generates a signal to cause the heating element to cease emitting heat, to return the temperature difference to the desired value (e.g., a value of about 2° C.). The signal applied to the heating element can be stored to a memory, transmitted using a communication interface, and/or read out to a user interface (such as a display). In this case, the signal could show a decrease, since as it sending controls to cause the heating element to cease emitting heat.

More precise temperature measurement, i.e., measurements that avoid the influence of changes in body temperature, may be obtained through use of differential temperature measurement according to the principles herein. The differential temperature measurement can be performed using two or more temperature sensors, including a reference temperature sensor that is not coupled to a heating element; and a sense temperature sensor that is coupled to and heated by a heating element (forming a flow sensor). The temperature sensor coupled with the heating element may be disposed on a distal portion or a proximal portion of an elongated member such as but not limited to a rod catheter or a guidewire, or a distal portion or a proximal portion of an elongated member that includes an inflatable and/or expandable body. In an example, the reference temperature sensor

can be disposed at least about 0.5 cm, at least about 1 cm, at least about 1.5 cm, or at least about 2 cm or more distance spaced apart from the flow sensor.

In an example, a device according to any of the principles herein and in any of the figures, including FIGS. 3A through 8B or FIG. 11, can include two or more flow sensors, including a plurality of flow sensors. The two or more flow sensors can be coupled via the control module to a single reference temperature sensor, or each flow sensor may be coupled to a respective reference temperature sensor.

In an example implementation, the signal to the heating element can be a time-varying voltage signal. For example, the excitation of the heating element and the temperature sensor of the flow sensor can be using an AC frequency greater than the inverse of tissue response time. As non-limiting examples, signals at AC frequencies ranging from about 1 kHz to about 100 kHz can be used to drive the flow sensor to reduce the risk of accidentally causing fibrillation. Operating at frequencies in this range also allows for higher current leakage.

In an example implementation, the signal to the heating element can be a voltage signal, a current signal, a digital signal, or any other signal that transmits instructions to cause the heater to heat at a desired temperature to maintain the desired temperature difference. The signal can be read out and/or plotted, stored to a memory, or otherwise communicated or transmitted.

In an example implementation, the control signal can be mapped to a flow rate through the analysis of multiple data runs and measurements, to generate a standard or other calibration chart that relates a value of a control signal to the physiological flow rate.

In an example, novel signal processing algorithms and associated methods, and control modules (including PID controller software) are provided for sensing and/or quantifying fluid flow rates.

FIG. 13 shows an example demodulation that can be implemented to extract the signal to the heating element from the noise in the signal. As a non-limiting example, processor-executable instructions that create a phase-locked loop (PLL) can be applied with a synchronous demodulation method to reject noise and derive the signal. At least one phase-locked loop can be used to lock-in the sensing signal to the control signal, and the sensing signal to the heater signal for the synchronous-demodulation. Since the same frequency is used to demodulate the data, the desired signal is extracted as a DC signal (representing the amplitude modulation). The synchronous demodulation provides a narrow band filter to reject noise injected by the environment of the device, which can interfere with the desired signal.

The capability of the temperature difference measurements and the control module facilitate measurement of pulsatile flow over a broad dynamic range. As a result, systems and methods herein provide a way to determine a clinical endpoint during a procedure, such as but not limited to a carotid sinus denervation, a carotid body disruption, a vagus nerve stimulation, a pulmonary artery denervation, a celiac ganglion disruption, a bladder trigone ablation, or a renal denervation procedure.

In an example, any system or device according to the principles described herein may be entirely or at least partially encapsulated by an encapsulating material, such as a polymer material (including any of the polymer materials described herein). An encapsulating material can be any material that can be used to laminate, planarize, or encase at least one component of a system or device described herein,

including any electronic or other type of component. For example, a method of fabricating any system or device according to the principles described herein can further include encapsulating the system or device. In an example, an encapsulating material can be disposed over, or otherwise applied to, an device that includes an inflatable and/or expandable body and the electronic circuit or a plurality of electrodes. In an example, a polyurethane can be used as the encapsulating material. In another example, the encapsulating material can be the same material as the material for the inflatable and/or expandable body. Encapsulating any portion of the systems or device described herein can be useful to enhance the mechanical stability and robustness of the system or device, or to maintain electronic performance of the electronic components of the system or device against a stress or strain applied to the system or device during use.

In any of the example devices according to the principles described herein, the encapsulating material can be formed from any material having elastic properties. For example, the encapsulating can be formed from a polymer or polymeric material. Non-limiting examples of applicable polymers or polymeric materials include, but are not limited to, a polyimide, a polyethylene terephthalate (PET), a silicone, or a polyurethane. Other non-limiting examples of applicable polymers or polymeric materials include plastics, elastomers, thermoplastic elastomers, elastoplastics, thermoplasts, thermoplastics, acrylates, acetal polymers, biodegradable polymers, cellulosic polymers, fluoropolymers, nylons, polyacrylonitrile polymers, polyamide-imide polymers, polyarylates, polybenzimidazole, polybutylene, polycarbonate, polyesters, polyetherimide, polyethylene, polyethylene copolymers and modified polyethylenes, polyketones, poly(methyl methacrylate, polymethylpentene, polyphenylene oxides and polyphenylene sulfides, polyphthalamide, polypropylene, polyurethanes, styrenic resins, sulphone based resins, vinyl-based resins, or any combinations of these materials. In an example, a polymer or polymeric material herein can be a DYMAX® polymer (Dymax Corporation, Torrington, Conn.) or other UV curable polymer, or a silicone such as but not limited to ECOFLEX® (BASF, Florham Park, N.J.).

For applications in biomedical devices, the encapsulant should be biocompatible. The stretchable interconnects can be embedded in a polyimide that also acts as a mechanical reinforcement.

In an example, any of the systems or device according to the principles herein can be disposed on the inflatable and/or expandable body such that a functional layer of the system or device lies at a neutral mechanical plane (NMP) or neutral mechanical surface (NMS) of the system or device. The NMP or NMS lies at the position through the thickness of the device layers for the system or device where any applied strains are minimized or substantially zero. In an example, the functional layer of a system or device according to the principles described herein includes the plurality of sensing elements, the coupling bus, and/or the stretchable electronic system that includes the flexible annular interconnect and the plurality of electrodes.

The location of the NMP or NMS can be changed relative to the layer structure of the system or device through introduction of materials that aid in strain isolation in various layers of the system or device. In various examples, polymer materials described herein can be introduced to serve as strain isolation materials. For example, the encapsulating material described hereinabove can be used to position the NMP or NMS, e.g., by varying the encapsulating material type and/or layer thickness. For example, the

thickness of encapsulating material disposed over the functional layers described herein may be modified (i.e., decreased or increased) to depress the functional layer relative to the overall system or device thickness, which can vary the position of the NMP or NMS relative to the functional layer. In another example, the type of encapsulating, including any differences in the elastic (Young's) modulus of the encapsulating material.

In another example, at least a partial intermediate layer of a material capable of providing strain isolation can be disposed between the functional layer and the inflatable and/or expandable body to position the NMP or NMS relative to the functional layer. In an example, the intermediate layer can be formed from any of the polymer materials described herein, aerogel materials or any other material with applicable elastic mechanical properties.

Based on the principles described herein, the NMP or NMS can be positioned proximate to, coincident with or adjacent to a layer of the system or device that includes the strain-sensitive component, such as but not limited to the functional layer. The layer can be considered "strain-sensitive" if it is prone to fractures or its performance can be otherwise impaired in response to a level of applied strain. In an example where the NMP or NMS is proximate to a strain-sensitive component rather than coincident with it, the position of the NMP or NMS may still provide a mechanical benefit to the strain-sensitive component, such as substantially lowering the strain that would otherwise be exerted on the strain-sensitive component in the absence of strain isolation layers. In various examples, the NMS or NMP layer is considered proximate to the strain-sensitive component that provides at least 10%, 20%, 50% or 75% reduction in strain in the strain-sensitive component for a given applied strain, e.g., where the inflatable body is inflated.

In various examples, the encapsulating material and/or the intermediate layer material may be disposed at positions coincident with the strain-sensitive component, including in the functional layer. For example, portions of the encapsulating material and/or the intermediate layer material may be interspersed with the strain-sensitive component, including at positions within the functional layer.

In any of the example devices according to the principles described herein, portions of the stretchable interconnects, the electrodes and portions of the main bus can be formed from a conductive material. In any of the examples described herein, the conductive material can be but is not limited to a metal, a metal alloy, a conductive polymer, or other conductive material. In an example, the metal or metal alloy of the coating may include but is not limited to aluminum, stainless steel, or a transition metal (including copper, silver, gold, platinum, zinc, nickel, titanium, chromium, or palladium, or any combination thereof) and any applicable metal alloy, including alloys with carbon. In other non-limiting example, suitable conductive materials may include a semiconductor-based conductive material, including a silicon-based conductive material, indium tin oxide or other transparent conductive oxide, or Group III-IV conductor (including GaAs). The semiconductor-based conductive material can be doped.

In any of the example structures described herein, the stretchable interconnects can have a thickness of about 0.1 μm , about 0.3 μm , about 0.5 μm , about 0.8 μm , about 1 μm , about 1.5 μm , about 2 μm or greater. The buffer structure and/or flexible base can have a thickness of about 5 μm , about 7.5 μm , about 9 μm , about 12 μm or greater. In any example herein, the encapsulant can have a thickness of

about 100 μm , about 125 μm , about 150 μm , about 175 μm , about 200 μm , about 225 μm , about 250 μm , about 300 μm or greater.

FIGS. 14A and 14B show cross-sectional layering structure of various components of the example devices described herein, which can be microfabricated. FIG. 14A shows the layering structure of an electrode, which includes a polymer layer 1402, a layer of conductive material 1404, and an annular structure of a polymer 1406 about a perimeter of the electrode. FIG. 14B shows the layering structure of a stretchable interconnect, which includes a polymer layer 1402, a layer of conductive material 1404, and a layer of a polymer 1406. FIG. 14C shows the layering structure of a flow sensor disposed on the inflatable and/or expandable body, which includes a polymer layer 1402, a layer of conductive material 1404, a layer of a polymer 1406, a flow sensor 1408, and an encapsulating layer 1410. In an example, the components can be fabricated on a carrier substrate, released from the carrier substrate, and disposed on the inflatable and/or expandable body.

A non-limiting example fabrication process for the example device of FIGS. 14A and 14B is as follows. The electrode can be fabricated using a microfabrication and transfer printing process to be between about 1 micron and about 5 microns thick. The sensors can be 3-omega sensors (described below) and the surface mount components (including the flow sensors) can be fabricated using use pure gold or Cu—Au—Ni fabrication techniques. The fabricated electronic structure are integrated on the surface of an inflatable and/or expandable body (such as but not limited to a balloon of a catheter). In the example device structures of FIGS. 14A and 14B, the polyimide can be about 25 microns in thickness. A polyurethane, formed of a resin and a solvent, can be used as an encapsulant to planarize the array of electrodes and other components on the surface of the inflatable and/or expandable body. The encapsulant helps to provide durability during sheath insertion of the example device into a tissue lumen.

In an example, the micro-fabricated flow sensors, electrode arrays (including ablation RF electrodes), electronics and other components of the example device are ultrathin, and have mechanical properties substantially similar or matched with the mechanical properties of the inflatable or expandable surface.

Systems and methods are described for performing a procedure on a tissue, including a renal artery, using any example device described herein. The example method includes disposing an example device in proximity to the tissue, applying the treatment to be applied to the tissue, and recording the flow measurement of the flow sensor as described herein to provide an indication of the flow rate of a fluid in proximity to the example device.

In an example, the treatment can include applying an ablation or applying energy in the form of RF energy, heating, or cryo (extreme cold) to the tissue. In an example, the treatment is performed to disrupt nerves in proximity to the tissue.

In an example, the method can be performed with an example device that includes a flow sensor element configured as a heating element in proximity to a temperature sensor. In this example, the operating point of the heating element can be monitored to provide an indication of flow rate. In an example, the recording of the flow measurement of the flow sensor can be performed subsequent to applying the RF energy to the surface of the tissue proximate to the RF electrode. In another example, the recording of the flow measurement of the flow sensor can be performed prior to

the applying of the RF energy to the surface of the tissue proximate to the RF electrode.

In an example, the temperature measurement may be performed before and after application of the RF energy, to obtain an indication of the flow rate of the fluid (such a blood) prior to and subsequent to the treatment procedure being performed.

In an example, systems, methods and devices for monitoring an efficacy of, determining a clinical endpoint for, a procedure. According to the principles described herein, the procedure can be any procedure to disrupt the renal nerves, such as but not limited to an ablation, including through applying energy in the form of RF energy, heating, or cryo (extreme cold) to the nerves. The procedure is not performed completed blindly with no feedback on the success of the procedure, with potential risk of damage to tissue. The example systems, methods and devices described herein provide an assessment of a renal denervation procedure based on renal hemodynamics (including based on the measures of fluid flow rate).

In any example described herein, an assessment module is provided according to the systems and methods described herein, where the assessment module includes a processor and a memory storing processor executable instructions. Execution of the processor executable instructions causes the assessment module to perform the activities associated with any method described herein, including using the data indicative of flow rate to provide an indication of the efficacy of a clinical procedure.

In an example, the example method can include using an indication of an increase in the flow rate of the fluid subsequent to the performance of the treatment as an indicator of the efficacy of the treatment procedure to disrupt the nerves (including the efficacy of applying the RF energy to the tissue). For example, a pre-set value of fluid flow rate or clinically desired percentage increase in flow rate can be used as an indicator of the efficacy of the procedure, including being used as an indication of an end-point of performance of the procedure. As a non-limiting example, a baseline flow rate can be measured using the flow sensors described herein prior to performing the procedure to disrupt the nerves. A desired pre-set value of fluid flow rate or clinically desired percentage increase in flow rate can be determined based on the baseline flow rate. For example, the pre-set value of fluid flow rate or clinically desired percentage increase in flow rate can be set as the amount needed to return the flow rate to an average, mean or median range of values for renal blood flow rate. In a feedback assessment, the procedure can be performed, the flow rate subsequently re-measured/re-determined based on flow sensor measurement data according to the principles described herein, and the re-measured flow rate compared to the pre-set value of fluid flow rate or clinically desired percentage increase in flow rate. If the desired pre-set value of fluid flow rate or clinically desired percentage increase in flow rate is not attained, the procedure can be repeated and the flow rate re-measured. If the desired pre-set value of fluid flow rate or clinically desired percentage increase in flow rate is attained, it signals the endpoint, and the procedure can be discontinued. In an example, the example method can include using an indication of little or no increase in the flow rate of the fluid subsequent to the performance of the treatment as an indicator of a lack of the efficacy of the treatment (including the efficacy of applying the RF energy to the tissue), or as an indication that the treatment procedure should be repeated, discontinued or modified. If the desired pre-set value of fluid flow rate or clinically desired percentage increase in flow

rate is not attained, the procedure can be modified to achieve the desired outcome. In an example, the feedback of performing the procedure, re-measuring the flow rate and comparing to the pre-set value of fluid flow rate or clinically desired percentage increase in flow rate can be repeated until the endpoint is signaled.

While the assessment is described relative to a procedure on a renal artery, the assessment of the efficacy of a procedure can be performed in other systems. For example, an assessment described herein for determining the efficacy of a procedure using flow measurements can be applied to procedures being performed in other tissue lumen, such as pulmonary veins, coronary arteries, peripheral blood vessels, cardiac lumen, and any other lumen in which flow can be assessed.

In an example, the method can include activating at least one pacing electrode of the example device to deliver an electrical stimulation to a portion of the tissue proximate to the pacing electrode. For example, the method can include delivering the electrical stimulation to the portion of the tissue proximate to the pacing electrode prior to recording a flow measurement (including recording a flow measurement of a flow sensor).

A non-limiting example process sequence, for performance of a procedure on renal artery tissue using an example device that is configured as a balloon catheter, is as follows:

Perform initial measurement (e.g., obtain a baseline flow)

Inflate catheter balloon to block blood flow

Measure renal flow using any of the example devices or methods described herein

Pace the renal artery (e.g., apply electrical signals to tissue using electrodes of the system)

Deflate catheter balloon

Measure "pre-ablation" flow using any of the example devices or methods described herein

Inflate catheter balloon

Perform ablation of the renal artery (e.g., apply energy to tissue to induce lesions and necrosis, including RF energy, heating, and cryoablation)

Deflate catheter balloon

Measure "post-ablation" flow using any of the example devices or methods described herein

A non-limiting example process sequence, for renal denervation on renal artery tissue using an example device that is configured as a balloon catheter, is as follows:

Pace the renal artery (e.g., apply electrical signals to tissue using electrodes of the system)

Measure "pre-ablation" flow rate using any of the example devices or methods described herein

Perform ablation of the renal artery (e.g., apply energy to tissue to induce lesions and necrosis, including RF energy, heating, and cryoablation)

Pace the renal artery (e.g., apply electrical signals to tissue using electrodes of the system)

Measure "post-ablation" flow rate using any of the example devices or methods described herein

The flowchart of FIG. 15 shows another non-limiting example method for performing an assessment during performance of a procedure, including an ablation procedure. In this example, a two-fold or three-fold increase in blood flow rate in the renal artery is the pre-set condition used as an indicator of an endpoint of applying the procedure in a feedback assessment. In block 1502, a baseline flow rate is measured. In block 1504, a procedure is performed on the tissue, such as but not limited to, a procedure performed using an example device described herein. In block 1506, the flow rate subsequently re-measured/re-determined based

on flow sensor measurement data according to the principles described herein. In block 1508, in a feedback assessment, the re-measured flow rate is compared to the pre-set value of fluid flow rate or clinically desired percentage increase in flow rate. If the desired pre-set value of fluid flow rate or clinically desired percentage increase in flow rate is attained (block 1510), it signals the endpoint (1512), and the procedure can be discontinued. If the desired pre-set value of fluid flow rate or clinically desired percentage increase in flow rate is not attained (block 1514), the procedure can be repeated (block 1516) and the flow rate re-measured and compared to the pre-set value of fluid flow rate or clinically desired percentage increase in flow rate (1518). If the desired pre-set value of fluid flow rate or clinically desired percentage increase in flow rate is attained (block 1520), it signals the endpoint (1512), and the procedure can be discontinued. If the desired pre-set value of fluid flow rate or clinically desired percentage increase in flow rate is not attained (block 1522), the procedure can be modified to achieve the desired outcome. For example, as shown in block 1524, the position of the instrument can be changed to some other region of the tissue and the treatment procedure repeated. In an example, the feedback of performing the procedure, re-measuring the flow rate and comparing to the pre-set value of fluid flow rate or clinically desired percentage increase in flow rate can be repeated until the endpoint is signaled.

In an example, an assessment module is provided according to the systems and methods described herein, where the assessment module includes a processor and a memory storing processor executable instructions. Execution of the processor executable instructions causes the assessment module to perform any of the example methods described herein, including in connection with FIG. 15.

The example systems, methods and apparatus herein can be used to improve the monitoring of stages of performance of a procedure as well as the completion of the procedure. Measurement of pulsatile fluid flow prior to performance of a procedure being performed can be used to provide quantitative values for parameters indicative of a baseline fluid flow. Measurement of pulsatile fluid flow during pre-cycle and post-cycles during performance of a procedure can be used to provide feedback, e.g., to a clinician or other practitioner, on the efficacy of the procedure. Based on an analysis of the flow rate measurements, the end-point of a procedure can be determined. For example, the method can be implemented for sensing and treatment in a tissue lumen. For example, in a renal denervation procedure, the elongated body can be inserted into a sheath and guided through the femoral vein until it reaches the renal artery. Sensors can be used to map or image renal nerves, deliver ablation energy, or monitor tissue properties, in conjunction with measurement of fluid flow rates, before, during, and after an ablation procedure or other procedure.

In an example, the efficacy of the performance of stages of a procedure can be monitored through an analysis of the time-dependence of the fluid flow rates. For example, a change in a time constant associated with the flow rate can be used as a measure of the efficacy a given stage in the performance of procedure. An example method based on analysis of the time-constant is as follows. Any example device herein, comprising any of the flow sensors, can be disposed proximate to the tissue. In this example, the device includes at least one component configured to apply the pacing, ablative, denervation, or any other treatment procedure being performed. The at least one component to perform the treatment procedure on the portion of the tissue is

activated, and the at least one flow sensor is used to perform at least one flow measurement. Each of the at least one flow measurement could be used to provide data indicative of a change in the flow subsequent to the treatment procedure of a fluid proximate to the apparatus. An analysis of the data indicative of the flow of the fluid can be used to determine at least one time-constant associated with the data. For example, as shows in FIG. 16, a time constant (τ_0) may be associated with a flow rate response prior to performance of a procedure, while obtaining flow having a different time constant (τ_d) can be deemed an indicator of the end-point of the procedure. The at least one time-constant associated with the data can be compared to a time-constant indicative of the flow of the fluid prior to performance of the treatment procedure. Any observed differences can be used to provide an indication of the efficacy of the treatment procedure.

In an example, multiple stages of the procedure can be repeated until the difference is low, or falls in a previously-specified range of values. Based on this analysis, an indication of an endpoint of a treatment procedure can be provided or displayed.

In an example, the time constant can be analyzed to provide a measure of the rate of change in the flow from a highest value following the treatment procedure to a steady-state value at a later time. An example method can include determining a first order rate of change with time of the at least one time constant and/or a second order rate of change with time of the at least one time constant. Another example method can include comparing the first order rate of change with time of the at least one time constant to a standard for the first order rate of change, where the comparison provides a second indication of the efficacy of the medical treatment procedure. Comparing the second order rate of change with time of the at least one time constant to a standard for the second order rate of change can be used to provide an indication of the efficacy of the medical treatment procedure.

In an example, the values of time constant and/or flow rate data gathered from a plurality of subject having a known condition can be used to provide an indication of a degree of success of a procedure or a potential for recovery from the procedure of an unclassified subject. The analysis of the values of time constant and/or flow rate data gathered from a plurality of previously classified subject can be used to provide parameter indicative of a likelihood of success of the procedure, the projected recovery time, and/or a risk of relapse of subject. The classified subjects have previously undergone any one or more procedures. The values of time constant and/or flow rate data may have been gathered prior to, during, and/or after completion of the one or more procedures. The values of time constant can include the first order measure of the time constant, the first-order rate of change (first derivative) of the time constant, and/or the second-order rate of change (second derivative) of the time constant. Any number of the plurality of known subjects may have been classified as to the degree of success of the procedure performed, the observed recovery time, and/or the incidence of relapse of subject(s). The values of time constant and/or flow rate data gathered from the plurality of subjects, and the classified parameters of their known conditions, can be used to train a classifier. The classifier can be generated as a look-up table, a calibration standard, or a machine-learning tool. For example, the values of time constant and/or flow rate data gathered from the plurality of subjects, and the classified parameters of known conditions, can be used to train a machine-learning tool to provide the subject classifier (or patient classifier).

The classifier can be used to take as input data from an unclassified subject, and generate as output an indication of a classification of a condition of that subject. For example, the classifier could be used to classify the subject as to a likelihood of success of the procedure, the projected recovery time, and/or a risk of relapse. In operation, data indicative of a flow rate of an unclassified subject can be gathered prior to, during, and/or after completion of a procedure, and provided as input to the classifier. The classifier can output the indication of the classification of the subject. In an example, the result from the classification of the unclassified subject may result in modification of the procedure while it is being performed (e.g., if the classifier indicates a potential for a relapse), used as an indication of the endpoint of the procedure, and/or result in a determination of an optimal recovery or rehabilitation regimen. In an example, the classification of the subject using the classifier can be used to determine at least one drug, biologic, or other substance to be administered to the subject.

The example machine-learning tools can be supervised learning tools (including support vector machines), unsupervised learning tools (including clustering analysis), or semi-supervised learning tools. As non-limiting examples, the learning tool can be an artificial neural network (ANN), a Bayesian network, a decision tree, or any other applicable tool.

In an example, a system, apparatus and method is provided for monitoring a hemodynamic effect during a medical treatment procedure performed on a vascular tissue. Parameters indicative of the hemodynamics of the fluid flow indicate the motion or equilibrium state of the fluid. The method can include disposing in proximity to the tissue an example device according to the principles described herein (such as but not limited to an example device as described in connection with any of FIG. 3A-8B, 11, or 23-27). At least one component of the example device to perform a medical treatment procedure on the portion of the tissue is activated. A substance that causes a change in dimension of the vascular tissue is administered. At least one flow sensor of the example device is used to perform at least one flow measurement. The at least one flow measurement provides data indicative of a change in the flow of a fluid proximate to the example device subsequent to the medical treatment procedure. The data indicative of the flow of the fluid is analyzed to determine at least one parameter indicative of the change in the hemodynamics of the fluid. A reduction in the change in the hemodynamics of the fluid can be used as an indicator of the efficacy of the medical treatment procedure.

The at least one component can be, but is not limited to, an ablative component. The medical treatment procedure can be, but is not limited to, a denervation procedure.

In an example, several stages of the method can be repeated until the rate of reduction of the change in the hemodynamics of the fluid falls below a specified value. In an example, an indication of an endpoint of the medical treatment procedure can be generated when the rate of reduction of the change in the hemodynamics of the fluid falls below the specified value. The example method can include displaying the indication of the endpoint of the medical treatment procedure on a display, as described in greater detail below.

The substance can include an endogenous substance and/or an exogenous substance. For example, the substance can include a calcium channel blocker, a cAMP-mediated stimulant, or a nitrovasodilator. In another example, the substance can include a dopamine, adenosine, prostacyclin, saline, or

nitric oxide. The substance can include a vasodilation substance or a vasoconstriction substance.

FIG. 17 shows a block diagram of an example system including an assessment module, according to the systems and methods described herein. A non-limiting example of the system 1700 according to the principles described herein is illustrated in FIG. 17. The system 1700 includes at least one communication interface 1711, at least one memory 1712, and at least one processing unit 1713. The at least one processing unit 1713 is communicatively coupled to the at least one communication interface 1711 and the at least one memory 1712. The at least one memory 1712 is configured to store processor-executable instructions 1714 and an assessment module 1715. As described in greater detail herein, the assessment module 1715 can be applied to determine, based on the flow sensor measurement data 1716, the indication of the flow rate of fluid in the tissue lumen, including to perform a differential comparison of flow sensor measurements or using the measures of flow rate to provide an indication of the efficacy of a procedure being performed on the tissue (such as but not limited to a procedure to disrupt nerves). In a non-limiting example, the at least one processing unit 1713 executes the processor-executable instructions 1714 stored in the memory 1712 at least to provide the feedback described herein during performance of a procedure. The at least one processing unit 1713 also executes processor-executable instructions 1714 to control the memory 1712 to store, or to control the communication interface 1711 to transmit 1717 to, e.g., a user interface or to a controller for any of the example devices described herein, at least one of an indication of the flow rate, an indication of an endpoint for the procedure, an indication of an efficacy of the procedure, and a suggested modification of the procedure.

In any example implementation according to the principles described herein, readings of 3-omega sensors can be used as the flow sensor on any of the devices described herein to provide an indication of the rate of flow of the fluid. The 3-omega sensors have similar fabrication processing steps as the pacing electrodes or the ablation electrodes. FIG. 18A shows a non-limiting example of a 3-omega sensor. The 3-omega sensors have intricate filamentary patterns, which can survive extreme mechanical bending and twisting and yet maintain performance. The 3-omega sensors measure blood flow by assessing minute changes in local temperature. Example results collected in a perfusion chamber with preset flow rates are shown in FIG. 18B. The 3-omega sensors can be disposed proximate to the inflatable and/or expandable body (including at the distal portion of the catheter). The 3-omega sensor can be disposed on the example device such that the 3-omega sensor is disposed within a mid-point of a tissue lumen (location of maximum flow velocity) and three other locations near the wall of the tissue lumen. Data collected across multiple 3-omega sensors in this configuration can facilitate flow rate measurements at multiple positions inside the tissue lumen. The sensitivity of the 3-omega sensors (such as the example of FIG. 18A) is in the range compatible with blood flow rates that exist in vivo (~5-50 cm/s flow rates).

In any example implementation according to the principles described herein, the flow sensing can be performed using other techniques. For example, an ultrasound measurement can be performed to provide an indication of the rate of flow of fluid pre-renal denervation procedure and/or post-renal denervation procedure to provide the feedback for determining the end-point or a procedure or to determine whether the procedure should be modified. As another

example, an optical measurement can be used to provide the indication of the rate of flow of fluid pre-renal denervation procedure and/or post-renal denervation procedure to provide the feedback for determining the end-point or a procedure or to determine whether the procedure should be modified. Other applicable flow sensing technology is a time-of-flight measurement, where the flow behavior of a tracker fluid introduced into the renal artery is measured to used to provide the indication of the rate of flow of fluid pre-renal denervation procedure and/or post-renal denervation procedure.

Fluid flow monitoring before, during and after delivery of nerve pacing and delivery of a treatment according to the principles described herein (including ablation energy) are powerful capability sets, that when offered in a single spiral catheter, can enhance the efficacy of a treatment procedure (including a renal denervation procedure). Variations in blood flow change the local steady-state temperature, which is measured with the 3-omega sensors. Absence of modulation in renal blood flow during pacing can indicate that ablation was successful and enable physicians to determine the end point of the renal denervation procedure.

In an example implementation, flow in a perfusion chamber can be systematically measured that provides programmable fluid volume velocity to test the sensitivity of a measurement system. Fluid flow rates can be systematically characterized at various ambient temperatures, ionic strengths, and viscosities to test how heat flux, electro-osmosis (during electrical stimulation) and fluid boundary layer thickness affect flow. The perfusion chamber can be equipped with electrical sensors that allow concomitant testing of pacing and ablation.

An example method for performing a procedure is described in connection with FIG. 19. The example method includes disposing 1902 an example device according to the principles described herein in proximity to a tissue, the device including a catheter, at least one flow sensor disposed on a portion of the catheter, at least one component coupled to the catheter to perform an ablation procedure on a portion of a tissue proximate to the catheter, and an assessment module coupled to the flow sensor to receive data indicative of at least one flow measurement from the at least one flow sensor and provide an indication of the efficacy of the ablation procedure based on the data indicative of at least one flow measurement. The example method also includes applying 1904 the ablation procedure to the surface of the tissue proximate to the catheter and recording 1906 a measurement of the flow sensor to provide an indication of the efficacy of the ablation procedure.

FIG. 20 shows an example architecture of an illustrative computer system 2000 that can be employed to implement any of the systems and methods described herein. The computer system 2000 of FIG. 20 comprises one or more processors 2020 communicatively coupled to memory 2025, one or more communications interfaces 2005, and one or more output devices 2010 (e.g., one or more display units) and one or more input devices 2015.

In the computer system 2000 of FIG. 20, the memory 2025 may comprise any computer-readable storage media, and may store computer instructions such as processor-executable instructions for implementing the various functionalities described herein for respective systems, as well as any data relating thereto, generated thereby, or received via the communications interface(s) or input device(s). The processor(s) 2020 shown in FIG. 20 may be used to execute instructions stored in the memory 2025 and, in so doing, also

may read from or write to the memory various information processed and or generated pursuant to execution of the instructions.

The example computer system **2000** also includes an assessment module **2030**. Assessment module comprises processor-executable instructions for performing any of the methods described herein to, for example, provide an indication of a flow rate, or to provide an indication of the efficacy of a procedure to disrupt nerves based on the measured values of flow rate. Processor **2020** can be used to execute the processor-executable instructions in connection with assessment module **2030**.

The processor **2020** of the computer system **2000** shown in FIG. **20** also may be communicatively coupled to or control the communications interface(s) **2005** to transmit or receive various information pursuant to execution of instructions. For example, the communications interface(s) **2005** may be coupled to a wired or wireless network, bus, or other communication means and may therefore allow the computer system **2000** to transmit information to and/or receive information from other devices (e.g., other computer systems). Communication interface(s) **2005** also may be in communication with an external network **2035**. In some implementations, the communications interface(s) may be configured (e.g., via various hardware components or software components) to provide a website or applications program (an App) on a handheld device as an access portal to at least some aspects of the computer system **2000**. Non-limiting examples of such hand-held devices are tablets, slates, smartphones, electronic readers, or other similar hand-held electronic devices.

The output devices **2010** of the computer system **2000** shown in FIG. **20** may be provided, for example, to allow various information to be viewed or otherwise perceived in connection with execution of the instructions. The input device(s) **2015** may be provided, for example, to allow a user to make manual adjustments, make selections, enter data or various other information, or interact in any of a variety of manners with the processor during execution of the instructions.

FIGS. **21A** and **21B** show the results of example measurement using an example device according to the principles described herein. FIGS. **21A** and **21B** show data from flow sensor measurements over a dynamic range of flow rates (from about 100 mL/min to about 600 mL/min) for a flow sensor strategically tuned for renal hemodynamic. FIG. **21A** shows measurements made for a 50 microAmps sensor. FIG. **21A** shows measurements made for a 20 microAmps sensor.

FIGS. **22A** and **22B** show the results of example use of an example device according to the principles described herein for use in performing an ablative procedure at about 0.2 W to about 0.3 W of power using electrodes for different exposure times (5 sec, 10 sec, 15 sec, 30 sec, 60 sec). The ablation electrodes are shown to generate lesions within about 5 seconds of contact with tissue, without charring. It is observed that a lesion is generated once the electrodes are in contact with the tissue, soft contact was sufficient to generate lesions, without excess pressure being exerted.

An non-limiting example measurement implementation is described. A system according to the principles described herein can be used to process differential measurement. If one sensor is used, the body temperature of the subject would be taken into account as well as static flow of the subject. This may require calibrations that may differ from patient to patient, leading to less accurate results or may require the physician to slow the procedure to take separate

body temperature static blood flow measurements in addition to the renal artery flow measurement.

Non-limiting examples of the innovations described in this disclosure include:

- a) Expediting up the clinical procedure;
- b) Providing more accurate results to the end point in therapy; and
- c) Reducing the amount of computation required.

In a non-limiting example, temperature sensing devices can be used in combination with a catheter to provide flow measurements. Electrical circuits can be used to provide differential measurements. Thin, stretchable, flexible and/or conformal electronics can be used to provide thin and conformal means to deploy the sensors described herein on the balloon of the catheter. The flow sensing systems, device, and methods described herein can be used for blood flow quantification and for other types of fluid flows.

In different example implementations, the change in flow can be reported to the clinician via direct values. The changes in flow can be used to show the stage, the progress, or the degree of success, of a procedure being performed, such as but not limited to an ablation procedure, for example, by indicating on a console or display device the procedure status. For example, a change in the flow rate above a defined value or threshold, can be used to signal or trigger an action. In an example, the action can be the turning on of an indicator on the catheter device, or the display of an icon, numeric value or chart on a display. In an example, the signal or trigger of the action can be used to provide the indication of the stage, the progress, or the degree of success of a procedure.

According to the example systems, methods and devices herein, sensing technology onboard catheters are described that employ thin, conformal arrays of sensors that can deform with the curvilinear structure of various balloon and spiral-shaped catheters. The ability to integrate conformal sensors along with silicon-based electronics on spiral-shaped extrusions and balloons facilitates, for the first time, ways to integrate multimodal sensory elements, micro-light emitting diodes (μ LEDs) and integrated circuit building blocks (i.e. amplifiers and logic gates) onboard catheters, thereby optimizing sensing while at the same time, not impacting the mechanical properties.

FIGS. **23A-23G** illustrates examples of multi-electrode and balloon catheter devices, according to the principles described herein. FIGS. **23A-23G** illustrates examples of multi-sensing element (including multielectrode) devices and catheter devices. The devices in FIGS. **23A-23D** include passive wires with polyimide-based encapsulation. The wires are exposed in select areas, thus forming electrode contacts. The electrode array can include, for example, 64 electrodes. FIGS. **23E-23G** show the balloon-based ablation catheters that can be used to apply cryo-, laser-, and high intensity ultrasound-forms of therapy, respectively, when deployed proximate to tissue. Any system according to the principles described herein can be implemented using any of the catheters shown in FIGS. **23A-23G**.

Other non-limiting examples of catheters that are applicable to the systems, methods, and apparatus described herein include Mallecot catheters, spiral coil catheter, mesh catheters, single-Rod catheters, compliant balloon-based catheters, non-compliant balloon-based catheters, lasso-shaped catheters, multispline catheters, dilatation balloon catheters, and angioplasty balloon catheters.

Examples of this kind of device are shown in FIGS. **24A-24D**. Electrodes, flow sensors and μ LEDs are able to withstand the significant mechanical strains caused by

repetitive inflation and deflation cycles of the balloon by virtue of their nanomembrane form factor and the serpentine interconnect geometries, which help to absorb mechanical strains. FIGS. 24E and 24F highlight alternative forms of sensing—temperature sensors, electrodes and flow sensors on conformal substrates. The flow sensing and electrode elements are useful for RSDN catheters, because assessment of blood flow can be achieved quickly, without the need for separate diagnostic devices.

In an example, 3-omega sensor arrays are used to measure thermal conductivity and other related thermal, mechanical and material properties that relate to thermal conductivity. To measure flow, the sensors are each positioned perpendicularly to the flow direction. Such a configuration can be compatible with the design of a spiral shaped catheter system. AC current is applied across each sensor and the resulting AC voltage is measured. This measured voltage decreases monotonically as flow rate increases and increases if the blood is stagnant or slows down. Computations of measured voltages according to any of the example devices herein can be calibrated using a perfusion chamber and the flow is assumed to follow the Hagen-Poiseuille equation and its respective assumptions. Measurements using 3-omega sensor technology are versatile because they can be used to extract several other physical parameters that may be relevant to clinicians. This sensing modality can be used to serve as a viable platform for catheters, e.g., that can be used to perform a renal denervation.

In an example, mechanical modeling of flow sensors and electrodes during mechanical stress can be performed. Using modeling simulations, the dynamic material and mechanical properties can be characterized for conformal sensor arrays on balloon and spiral-shaped catheters that experience significant bending and twisting during operation. This includes analytical and finite element modeling of the mechanics of flex electronics affixed to balloon catheters. The strain distributions obtained through analytical and computational modeling capture, quantitatively, the nature of deformations in the electronics layers. Characterization of the effective strain and displacement distributions in the sensor islands and serpentine interconnects provide important insights into critical fracture strains and buckling phenomena. Such characterization of conformal sensors can dramatically improve the way nanomembrane flow sensors and electrodes are designed and implemented on highly deformable substrates (i.e. deflectable catheters). Furthermore, the approach holds promise for increasing the understanding of the mechanical stresses involved during catheter deployment in vivo.

FIG. 25 shows non-limiting examples of flow sensors on rod-shaped catheters that include “clover-shaped” flow sensors. The metal rectangles are electrodes on the catheter. In some of the example catheters of FIG. 25, the flow sensors include angioplasty balloons with ablation electrodes (the circular pads). In the novel example systems herein, the clover flow sensors are combined with the balloon electrodes on a single device.

According to the systems and methods described herein, ablation electrodes can be embedded on angioplasty balloon along with the clover-shaped flow sensors on the proximal and distal sides of the balloon on the catheter extrusion. According to the novel systems and methods herein, a multifunctional balloon catheter that has (i) array of electrodes is coupled with (ii) flow sensors embedded on the catheter’s shaft proximate to the balloon. In some examples, the balloon catheter may include other sensors on the

balloon, such as but not limited to LEDs, contact sensors, pressure sensors, biological activity sensors, and temperature sensors.

In an example implementation, the catheter with balloon is deployed proximate to the renal tissue (or other portion of the renal system) in a deflated state. For example, once the catheter is in the renal artery, fluid flow can be measured (including blood flow). Once captured, the balloon can be inflated and the ablation can be performed. Once the ablation is completed, or at selected points during performance of the ablation, the balloon can be deflated and flow is sensed again to see what changes are measured. In this example, an increase in flow can be used to serve as an indicator of a successful ablation procedure.

In another example implementation, the nerve can be paced and the flow can be measured pre-ablation. The ablation cycle can be performed. Once the ablation is completed, or at selected points during performance of the ablation, the nerve can be paced and the flow can be measured again (including a post-ablation measurement). If the pacing is determined to causes a change in flow, this can be used as an indicator that the nerves are still active. If the pacing does not cause a shift in flow, this can be used as an indicator that the nerves have been successfully denervated. The flow sensors coupled with ablation electrodes according to the systems and methods described herein facilitate this novel analysis and determination of clinical endpoint.

FIG. 26 shows a non-limiting example of flow sensors on a spiral-shaped catheters. FIG. 27 shows a catheter with bipolar electrodes and metal interconnects disposed on its surface.

Example design and fabrication are described for examples of 4 flow sensors, 4 pacing electrodes and 4 ablation electrodes all co-located on spiral-shaped catheters. A custom data acquisition system is implemented, and the initial functionality of the flow sensors and electrodes is tested by deploying them in flow perfusion chambers. Example combined functionalities of the flow sensors, pacing electrodes and ablation electrodes in the renal arteries of live porcine models are also described. Spiral catheters containing the sensors and electrodes are used to measure blood flow during nerve stimulation immediately pre- and post renal ablation event. A comparative analysis is conducted of a catheter system’s performance, ease of use, and procedure time relative to other renal ablation devices being used in the clinical setting to gain insight into how having a clinical endpoint in RSDN helps to improve the overall procedure efficacy and safety.

Non-limiting examples of flow sensors, pacing and ablation electrodes on multifunctional spiral catheter in perfusion apparatus is described. Constrained spaces in the renal artery can reduce the number of devices that can be positioned inside. As a result, it can be challenging to deploy multiple devices in such a confined space as in the renal arteries. Multifunctional RSDN catheters are constructed with electrodes on spiral-shaped extrusions that are small enough to conform to the renal artery to enable electrical stimuli delivery without affecting measurements. Mechanically optimized nanomembrane electrodes are incorporated with 3-omega flow sensors that interface with the limited space of the renal artery. In an example, up to 8 electrodes ($0.25 \times 0.25 \text{ mm}^2$) and 4 ($1 \times 1 \text{ mm}^2$) sensors are fabricated to measure renal blood flow pre- and post-ablation events. A data acquisition system (National Instruments Inc.) is implemented, coupled with an Electrical stimulator console (Medtronic Inc.) to deliver the 5-10 W of energy to pace and ablate the renal nerves. This power supply can be used to

apply pacing energy. Using this new system, fundamental limits of the ablation and pacing electrodes with in vitro tissue can be characterized. In addition, a custom perfusion chamber can be built to test the flow sensing capabilities. Taken together, these new designs, microfabrication approaches and measurements using in-vitro models can provide insight into the optimal configuration of electrodes and flow sensors necessary determine changes in flow rate following renal denervation.

Non-limiting example pacing and ablation electrodes on spiral catheter and test performance in vitro are described. Ultrathin geometries impart flexibility to otherwise rigid and brittle materials. Ultrathin conformal nanomembrane sensors (~250 nm) embedded in thin polyimide and elastomeric substrates (~50-100 μm) in neutral mechanical plane layouts accommodate significant mechanical durability with radii of curvature less than about 1 mm. To achieve conformal sensors with such designs, arrays of electrodes can be formed on silicon. Lithographic processing and vertical trench wet-etching techniques yield isolated chiplets (~0.25×0.25 mm², and ~1-5 μm thick) that remain tethered to the underlying wafer through 'anchor' structures. This process can be used to yield electrodes that are referred to as 'printable', due to their ability to be removed and placed onto a target substrate with a soft, elastomeric stamp and transferred onto a spiral catheter. The attractive features of this approach include: (1) ultrathin circuit layouts for mechanical flexibility to conform to limited space in the renal artery, and (2) compatibility with other elements such as contact or flow sensors.

The utility of nanomembrane electrodes are tested by perform ablation measurements by driving RF energy (5-10 W) to show that renal nerves fibers can be ablated through arterial vessel. Histological assessment is performed of the nerves pre- and post ablation cycles to test nanomembrane electrode array performance and to see if the surface properties of the electrodes change over time (as a result of protein coating and/or electromosis phenomena). Measurements performed in the heart and on excised muscle tissue yield promising results on both pacing and ablation with this new class of nanomembrane electrodes.

A non-limiting example data acquisition system is described. Stimulation waveforms in the form of rectified triangular pulses with fixed amplitude of 10-20 V and 100-150 ms durations can be delivered through the pacing electrodes using instructions programmed into machine readable instructions. The waveform patterns are chosen strategically to induce renal nerve activity and to give rise to vasoconstriction or changes in local blood flow. The data acquisition system includes three modules to measure blood flow, induce nerve stimulation, and deliver ablation energy. The data from any of these modules can be transmitted to the assessment module to perform an assessment of efficacy as described in connection with any of the examples described herein. A National Instruments Inc. PXI-6289 (a multifunction M Series data acquisition (DAQ) system), controlled with custom machine readable instructions (including in LABVIEW™ software), controls voltages across the sensors.

Non-limiting example flow sensing, pacing and ablation using multifunctional spiral catheters in live animal models are described. Multifunctional balloon and spiral shaped catheter described in section 1 above are applied to flow sensing and ablation measurements in live animal models. Balloon catheters can be used. In an example, balloon catheters may have larger profiles that can affect flow. In a non-limiting example, to minimize effects of the catheter on

blood flow, spiral-shaped catheters can be used instead of balloons. Flow can be measured upon initial deployment in the renal arteries over the course of a few minutes to determine the initial average flow rate. Once established, pacing can ensue and flow can be monitored concurrently. A 20-30% reduction in flow can be expected during this step if the renal nerves are functioning properly. Once this initial calibration is completed, the same set of procedures can be run following renal ablation cycles. It is possible that the renal blood flow may shift to a different baseline than in the initial measurement. In an example, this is not used as an indicator of successful ablation. If ablation is successful, there can be an interpretable effect that can be apparent during pacing. That is, there may be little shift in flow during pacing because the vasoconstriction properties of the nerves can be dysfunctional, which can serve as the clinical endpoint of the procedure.

In an example, an example method for determining renal denervation endpoint when blood pressure and flow are modulated with nitroglycerine is described. To determine how changes in flow can be assessed with the sensors described herein, variations in blood flow caused by nitroglycerine lead to changes in blood pressure and renal blood flow rates before and after ablation can be monitored. Systemic injections of nitroglycerine can cause shifts in blood pressure that can give rise to changes in renal blood flow. Injections of nitroglycerine also can be monitored to determine an affect on blood flow pre-pacing and again following pacing.

In an example, leakage currents and encapsulation are described. Conformal flow sensor arrays can be fabricated using a multi-layer process, which has a thin layer polyimide as the encapsulating layer. Horizontal and vertical interconnect layers are insulated using this thin layer of polyimide. In an example system, leakage currents may escape and lead to noisy recordings, bubble formation in the fluid, or sensor deterioration over time. In an example, to prevent leakage currents in these systems, additional polymeric encapsulation (UV curable polyurethanes or parylenes) can be coated over the sensors, creating an additional ~10 m encapsulating layer to withstand current leakage effects. Over the course of a few hours (the extent of RSDN procedures), leakage currents may be manageable with polyurethane, parylene and UV curable encapsulation strategies.

Data visualization and signal fidelity is described. Data acquisition systems developed for recording flow, pacing and ablation may not be provided in a single module. The visualization of the measurements recordings and stimuli application may require feedback from multiple physicians. Interpretation of the flow data in real time can be challenging. A first generation data acquisition system is described for measuring and displaying flow. In an example, the user interface can be configured to be presented on the same LABVIEW™ display as the controls for pacing and ablation, thereby providing all of the catheter control features on a single console. This system architecture may be well suited for a product development implementation.

Renal nerve stimulation is described. In some examples, the nerve pacing electrodes may lose contact with the arterial vessel wall. This variability in good contact may cause poor denervation results. To counter this effect, x-ray imaging and electrode impedance recordings can be monitored to restore proper contact with the vessel wall.

Also provided herein is a user interface that can be used during a procedure to monitor the progress of the procedure and/or to provide an indication of an endpoint of the procedure. The user interface can be provided using an

apparatus for displaying representations of the parameters of an inflatable body and/or expandable body disposed proximate to a portion of a tissue that is being treated. According to the principles herein, the inflatable body and/or expandable body can include a plurality of sensors coupled to at least a portion of the inflatable body and/or expandable body. The apparatus can include a user interface, at least one memory to store processor-executable instructions, and at least one processing unit coupled to the at least one memory. Upon execution of the processor-executable instructions, the at least one processing unit controls the user interface to display at least one representation of the parameters of the inflatable body and/or expandable body.

FIGS. 28A and 28B show non-limiting examples of the types of representation of the parameters of the inflatable body and/or expandable body that can be shown on a display. FIG. 28A shows an example first representation of the state of the inflatable body and/or expandable body. The inflatable body and/or expandable body can be shown using a first form indicator 2802 to indicate that it is in an inflated/expanded state, or using a second form indicator 2804 to indicate that it is in a deflated/collapsed. FIG. 28B shows examples of the types of representations that can be used to indicate the state of at least one sensor of the plurality of sensors coupled to the inflatable body and/or expandable body. One or more of the sensors can be represented using a first activation indicator 2852 to indicate that respective sensor measures a signal below a threshold value, or using a second activation indicator 2854 to indicate that respective sensor measures a signal above or about equal to the threshold value.

In an example, the first activation indicator 2852 and the second activation indicator 2854 can be used to indicate a state of contact of a portion of the inflatable body and/or expandable body with a tissue. A signal below the threshold value can be interpreted as indicating that the at least one sensor is not in contact with a portion of the tissue, and a signal above or about equal to the threshold value indicates that the at least one sensor is in contact with a portion of the tissue.

In an example, the first activation indicator and the second activation indicator can be displayed as binary visual representations, e.g., ON/OFF or other binary indication.

In an example, the first activation indicator and the second activation indicator can be displayed as quantitative visual representations that correspond to a magnitude of the signal. For example, as shown in FIG. 28C, the display can show a feature (such as an arrow or bar) that changes to indicate a magnitude of a signal to a sensor. The example of FIG. 28C shows values for "contact" or "no contact". In other examples, the features in the display could be used to indicate relative magnitudes of any other parameter measured using a sensor. In an example, a graphical plot, such as shown in FIG. 28D also can be used to indicate the magnitude of the signal.

In an example, the sensor(s) may be flow sensor(s), and the first activation indicator and the second activation indicator can be displayed as quantitative visual representations that indicate the magnitude of parameters such as but not limited to an instantaneous velocity, a volumetric flow, or a vascular resistance of the measured fluid flow rate at each sensor.

In an example, the first form indicator and the second form indicator can be displayed as color-coded symbols. Each color-coded symbol can be used to indicative of a range of values of the magnitudes of the signal. For example, green can be used to indicate a low range of values below a

first threshold, yellow can be used to indicate a signal falling in a mid-range of values up to a second threshold, and red can be used to indicate a signal falling in a high range of values above the second threshold.

In an example, the first form indicator and the second form indicator could further be used to provide an indication of a spatial location of the corresponding at least one sensor relative to the inflatable body and/or expandable body. For example, the indicators 2852 and 2854 can be used to indicate the spatial location of the sensor that is activated.

In an example, the user interface can be configured to cause display of the representation of the inflatable body and/or expandable body and the representation of the state of activation of the sensor(s) in a staged process. No representation of the state of activation of the sensor(s) would be displayed while the representation of the inflatable body and/or expandable body is the first form indicator (indicating a deflated/collapsed state). The representations of the state of activation of the sensor(s) would be displayed once the representation of the inflatable body and/or expandable body is the second form indicator (indicating an inflated/expanded state). That is, the representations of the state of activation of the sensors may not be allowed to be display, until the inflatable body and/or expandable body is somewhat inflated/expanded (even if not fully inflated or expanded).

In an example, the user interface can be configured to display instructions to a practitioner (including a physician) at various stages of the procedure being performed. The example, the display can be configured to indicate when an endpoint of the procedure has been reached. If the procedure has not reached an endpoint, the display can be configured to display instructions to indicate to the practitioner to continue the procedure or modify the procedure (e.g., to move the catheter, guidewire or other elongated body or the inflatable body and/or expandable body, or to re-apply the treatment (e.g., the ablation). The user interface also can be configured to display of an indication of at least one stage of the procedure being performed on the portion of the tissue.

In an example shown in FIG. 29, the user interface can be used to display vascular resistance value(s) in numerical form and/or as a graph vs. time. The user interface also can be used to display data indicative of parameters such as but not limited to the systolic slope, the pulsatile flow, and the pulsatile pressure. The user interface can be configured to display values indicative of the instantaneous/volumetric flow in a short-time duration graph that shows granular flow readings. The user interface can be configured to display values of the instantaneous/volumetric flow in a long time-scale graph, e.g., over the course of the duration of the procedure (e.g., an hour-long procedure), to discern changes pre- and post-treatment (such as but not limited to the ablation).

While various inventive embodiments have been described and illustrated herein, those of ordinary skill in the art will readily envision a variety of other means and/or structures for performing the function and/or obtaining the results and/or one or more of the advantages described herein, and each of such variations and/or modifications is deemed to be within the scope of the inventive embodiments described herein. More generally, those skilled in the art will readily appreciate that all parameters, dimensions, materials, and configurations described herein are meant to be examples and that the actual parameters, dimensions, materials, and/or configurations will depend upon the specific application or applications for which the inventive teachings is/are used. Those skilled in the art will recognize, or be able to ascertain using no more than routine experimentation,

many equivalents to the specific inventive embodiments described herein. It is, therefore, to be understood that the foregoing embodiments are presented by way of example only and that inventive embodiments may be practiced otherwise than as specifically described. Inventive embodiments of the present disclosure are directed to each individual feature, system, article, material, kit, and/or method described herein. In addition, any combination of two or more such features, systems, articles, materials, kits, and/or methods, if such features, systems, articles, materials, kits, and/or methods are not mutually inconsistent, is included within the inventive scope of the present disclosure.

The above-described embodiments of the invention may be implemented in any of numerous ways. For example, some embodiments may be implemented using hardware, software or a combination thereof. When any aspect of an embodiment is implemented at least in part in software, the software code may be executed on any suitable processor or collection of processors, whether provided in a single device or computer or distributed among multiple devices/computers.

Also, the technology described herein may be embodied as a method, of which at least one example has been provided. The acts performed as part of the method may be ordered in any suitable way. Accordingly, embodiments may be constructed in which acts are performed in an order different than illustrated, which may include performing some acts simultaneously, even though shown as sequential acts in illustrative embodiments.

All definitions, as defined and used herein, should be understood to control over dictionary definitions, definitions in documents incorporated by reference, and/or ordinary meanings of the defined terms.

The indefinite articles “a” and “an,” as used herein in the specification, unless clearly indicated to the contrary, should be understood to mean “at least one.”

The phrase “and/or,” as used herein in the specification, should be understood to mean “either or both” of the elements so conjoined, i.e., elements that are conjunctively present in some cases and disjunctively present in other cases. Multiple elements listed with “and/or” should be construed in the same fashion, i.e., “one or more” of the elements so conjoined. Other elements may optionally be present other than the elements specifically identified by the “and/or” clause, whether related or unrelated to those elements specifically identified. Thus, as a non-limiting example, a reference to “A and/or B”, when used in conjunction with open-ended language such as “comprising” can refer, in one embodiment, to A only (optionally including elements other than B); in another embodiment, to B only (optionally including elements other than A); in yet another embodiment, to both A and B (optionally including other elements); etc.

As used herein in the specification, “or” should be understood to have the same meaning as “and/or” as defined above. For example, when separating items in a list, “or” or “and/or” shall be interpreted as being inclusive, i.e., the inclusion of at least one, but also including more than one, of a number or list of elements, and, optionally, additional unlisted items. Only terms clearly indicated to the contrary, such as “only one of” or “exactly one of,” or “consisting of,” will refer to the inclusion of exactly one element of a number or list of elements. In general, the term “or” as used herein shall only be interpreted as indicating exclusive alternatives (i.e. “one or the other but not both”) when preceded by terms of exclusivity, such as “either,” “one of,” “only one of,” or “exactly one of.”

As used herein in the specification, the phrase “at least one,” in reference to a list of one or more elements, should be understood to mean at least one element selected from any one or more of the elements in the list of elements, but not necessarily including at least one of each and every element specifically listed within the list of elements and not excluding any combinations of elements in the list of elements. This definition also allows that elements may optionally be present other than the elements specifically identified within the list of elements to which the phrase “at least one” refers, whether related or unrelated to those elements specifically identified. Thus, as a non-limiting example, “at least one of A, and B” (or, equivalently, “at least one of A or B,” or, equivalently “at least one of A and/or B”) can refer, in one embodiment, to at least one, optionally including more than one, A, with no B present (and optionally including elements other than B); in another embodiment, to at least one, optionally including more than one, B, with no A present (and optionally including elements other than A); in yet another embodiment, to at least one, optionally including more than one, A, and at least one, optionally including more than one, B (and optionally including other elements); etc.

What is claimed is:

1. A device for determining a flow rate of a fluid proximate to a portion of a tissue, comprising:

an elongated member having a proximal portion and a distal portion;

a flow sensor disposed proximate to the distal portion of the elongated member, the flow sensor comprising:

at least one temperature sensor; and

at least one heating element to heat an area proximate to the elongated member, at least a portion of the at least one heating element forming a cavity,

wherein:

at least a portion of the at least one temperature sensor is housed in a portion of the cavity; and

a temperature measurement of the temperature sensor provides a first indication of a flow rate of the fluid proximate to the flow sensor.

2. The device of claim 1, further comprising an inflatable and/or expandable body coupled to a portion of the elongated member and having a proximal portion and a distal portion, wherein the distal portion of the inflatable and/or expandable body is disposed proximate to the flow sensor.

3. The device of claim 2, further comprising an electronic circuit coupled with the inflatable and/or expandable body, wherein the electronic circuit comprises at least one stretchable interconnect, and wherein the electronic circuit is stretchable and conformable such that the electronic circuit accommodates an expansion of the inflatable and/or expandable body.

4. The device of claim 3, wherein the electronic circuit further comprises at least one passive electronic component and/or at least one active electronic component, and wherein the at least one stretchable interconnect electrically couples at least two electronic components of the electronic circuit.

5. The device of claim 3, wherein the electronic circuit further comprises a plurality of electrodes, and wherein at least one electrode of the plurality of electrodes is a radiofrequency electrode to deliver a radiofrequency energy to a surface proximate to the radiofrequency electrode.

6. The device of claim 3, wherein the electronic circuit comprises at least one ablative element.

45

7. The device of claim 1, wherein the device is adapted for performing a procedure on the portion of tissue, and wherein the procedure is a denervation procedure or a nerve stimulation procedure.

8. The device of claim 7, wherein the procedure is a carotid sinus denervation, a carotid body disruption, a vagus nerve stimulation, a pulmonary artery denervation, a celiac ganglion disruption, a bladder trigone ablation, or a renal denervation.

9. The device of claim 1, wherein the temperature sensor is a thermistor or a thermocouple.

10. The device of claim 1, wherein the elongated member is a catheter or a guide wire.

11. The device of claim 1, further comprising a reference temperature sensor disposed on a proximal portion of the elongated member.

12. The device of claim 11, wherein a comparison of a temperature measurement of the reference temperature sensor to a measurement of the flow sensor provides a second indication of a flow rate of the fluid.

13. The device of claim 1, wherein the at least one flow sensor is a plurality of flow sensors.

14. The device of claim 1, wherein the fluid is blood, and wherein the first indication of the flow rate of the fluid is indicative of a hemodynamic property of the fluid.

15. The device of claim 1, further comprising at least one component adapted to perform an ablative procedure.

46

16. The device of claim 15, further comprising at least one pacing electrode disposed on the inflatable and/or expandable body to deliver an electrical stimulation to a portion of the tissue proximate to the pacing electrode.

17. The device of claim 16, wherein the electrical stimulation is applied to the portion of the tissue prior to performing the ablation procedure.

18. The device of claim 1, wherein the operation of the heating element and the temperature sensor are coupled to provide a measure of a change in temperature caused by a change in the flow rate of the fluid.

19. The device of claim 1, wherein the flow sensor is encapsulated in a thermally-conductive encapsulant.

20. The device of claim 1, wherein the at least one heating element comprises a coiled resistive wire, and wherein a hollow portion of the coiled resistive wire forms the cavity.

21. The device of claim 1, wherein the at least one heating element comprises a thin-film patterned resistive element, and wherein the at least one heating element is formed in a substantially cylindrical conformation including the cavity.

22. The device of claim 21, wherein the thin-film patterned resistive element comprises a pattern of resistive elements disposed on a stretchable and/or flexible substrate.

23. The device of claim 22, wherein the resistive elements are formed in a linear pattern, a serpentine pattern, a boustrophedonic pattern, a zig-zag pattern, a wavy pattern, a polygonal pattern, or a substantially circular pattern.

* * * * *

专利名称(译)	导管或导丝装置包括流量传感及其使用		
公开(公告)号	US9801557	公开(公告)日	2017-10-31
申请号	US15/047314	申请日	2016-02-18
[标]申请(专利权)人(译)	MC10股份有限公司		
申请(专利权)人(译)	MC10 , INC.		
当前申请(专利权)人(译)	MC10 , INC.		
[标]发明人	GHAFFARI ROOZBEH LEE STEPHEN WORK JOHN WRIGHT JR JOHN A KLINKER LAUREN		
发明人	GHAFFARI, ROOZBEH LEE, STEPHEN WORK, JOHN WRIGHT, JR., JOHN A. KLINKER, LAUREN		
IPC分类号	A61B18/04 A61N1/05 A61B90/30 A61B18/14 A61B90/70 A61B34/35 A61B5/00 A61B5/027 A61N1/36 A61B90/00 A61B34/00 A61B18/00 A61B18/02 A61B18/18 A61B18/22 A61N7/02		
CPC分类号	A61B5/6851 A61B5/027 A61B18/1492 A61B34/25 A61B34/35 A61B90/30 A61B90/70 A61N1/0514 A61N1/36007 A61N1/36135 A61B2018/00541 A61B2018/00577 A61B2018/00642 A61B2018/00648 A61B2018/00666 A61B2018/00672 A61B2018/00678 A61B2018/00708 A61B2018/00744 A61B2018/ /00791 A61B2018/00797 A61B2018/00815 A61B2018/00821 A61B2018/00839 A61B2018/00863 A61B2018/00875 A61B2018/0212 A61B2018/1861 A61B2034/252 A61B2034/254 A61B2090/065 A61N7/02 A61B18/02 A61B18/22 A61B2018/00005 A61B2018/0022 A61B2018/00214 A61B2018/ /00267 A61B2018/00273 A61B2018/00386 A61B2018/00404 A61B2018/00434 A61B2018/00494 A61B2018/00511 A61B2018/00517 A61B2018/20361 A61B2018/205547 A61B2017/00088 A61B2017/ /00092		
代理机构(译)	尼克松皮博迪律师事务所		
优先权	13/844677 2015-10-27 US 61/733575 2012-12-05 US 61/728653 2012-11-20 US 61/668338 2012-07-05 US		
其他公开文献	US20160213262A1		
外部链接	Espacenet USPTO		

摘要(译)

提供了用于使用流量传感器进行流量监测的组织上执行程序的装置和方法。该装置包括细长构件，以及设置在细长构件上的至少一个流量传感器。流量传感器包括至少一个温度传感器和至少一个具有腔的加热元件。至少一个温度传感器的至少一部分容纳在空腔中。温度传感器的温度测量值提供了靠近流量传感器的流体的流速的指示。

