



(19) **United States**

(12) **Patent Application Publication**
Al-Ali

(10) **Pub. No.: US 2018/0055385 A1**
(43) **Pub. Date: Mar. 1, 2018**

(54) **PATIENT MONITOR FOR DETERMINING MICROCIRCULATION STATE**

A61B 5/02 (2006.01)
A61B 5/1455 (2006.01)
A61B 5/024 (2006.01)

(71) Applicant: **MASIMO CORPORATION**, Irvine, CA (US)

(52) **U.S. Cl.**
CPC *A61B 5/0261* (2013.01); *A61B 5/746* (2013.01); *A61B 5/7282* (2013.01); *A61B 5/7275* (2013.01); *A61B 5/6801* (2013.01); *A61B 5/14552* (2013.01); *A61B 5/14551* (2013.01); *A61B 5/02427* (2013.01); *A61B 5/02007* (2013.01)

(72) Inventor: **Ammar Al-Ali**, San Juan Capistrano, CA (US)

(21) Appl. No.: **15/709,189**

(22) Filed: **Sep. 19, 2017**

Related U.S. Application Data

- (63) Continuation of application No. 14/923,235, filed on Oct. 26, 2015, now Pat. No. 9,795,310, which is a continuation of application No. 14/160,316, filed on Jan. 21, 2014, now Pat. No. 9,192,312, which is a continuation of application No. 13/101,093, filed on May 4, 2011, now Pat. No. 8,666,468.
- (60) Provisional application No. 61/332,155, filed on May 6, 2010.

Publication Classification

- (51) **Int. Cl.**
A61B 5/026 (2006.01)
A61B 5/00 (2006.01)

(57) **ABSTRACT**

As placement of a physiological monitoring sensor is typically at a sensor site located at an extremity of the body, the state of microcirculation, such as whether vessels are blocked or open, can have a significant effect on the readings at the sensor site. It is therefore desirable to provide a patient monitor and/or physiological monitoring sensor capable of distinguishing the microcirculation state of blood vessels. In some embodiments, the patient monitor and/or sensor provide a warning and/or compensates a measurement based on the microcirculation state. In some embodiments, a microcirculation determination process implementable by the patient monitor and/or sensor is used to determine the state of microcirculation of the patient.

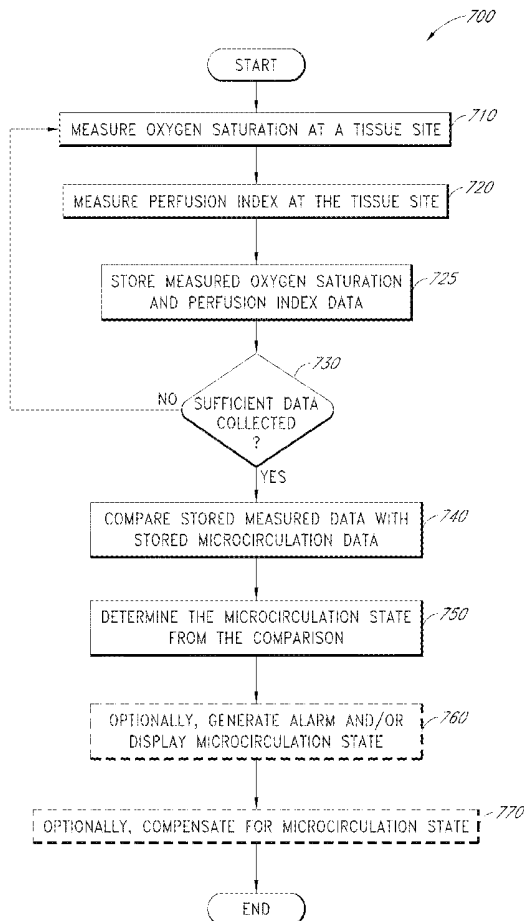

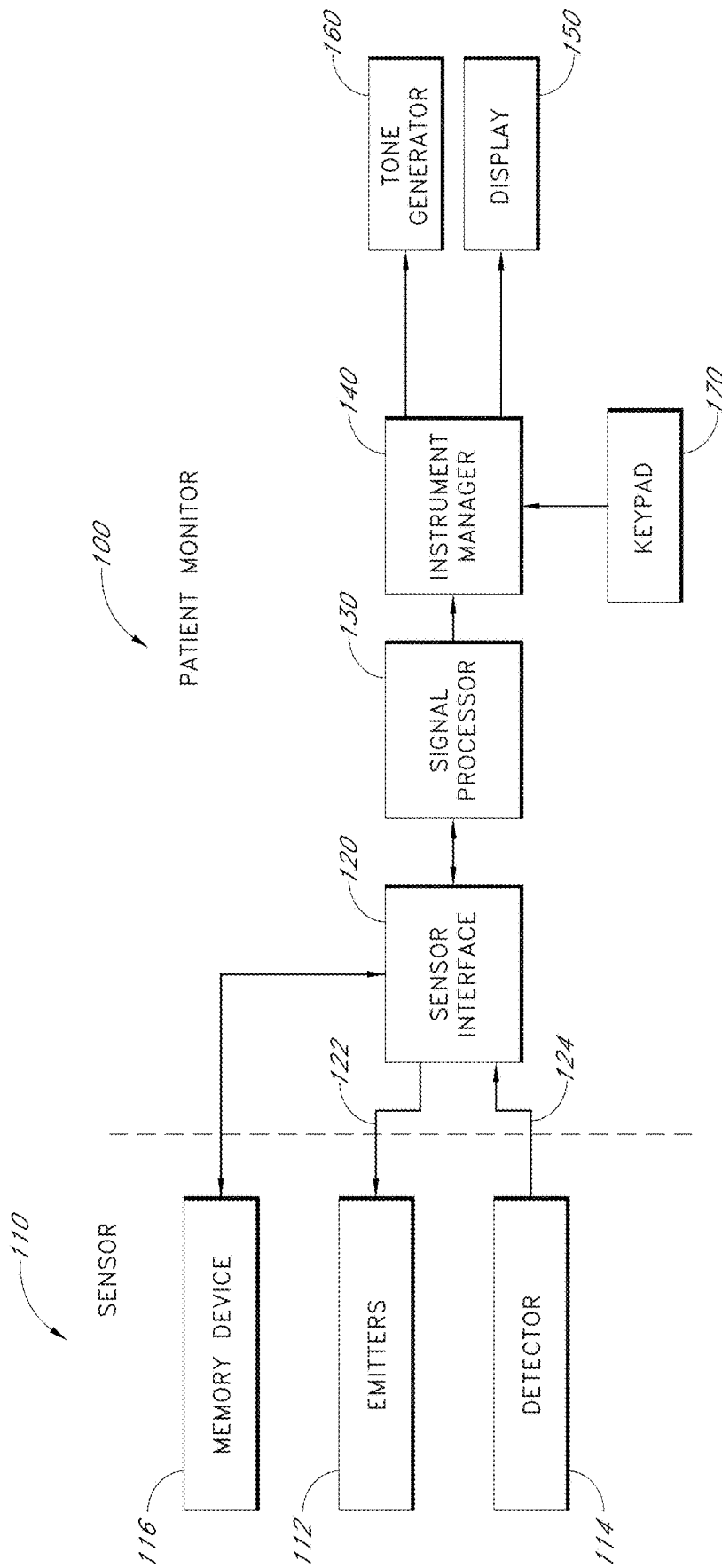

FIG. 1

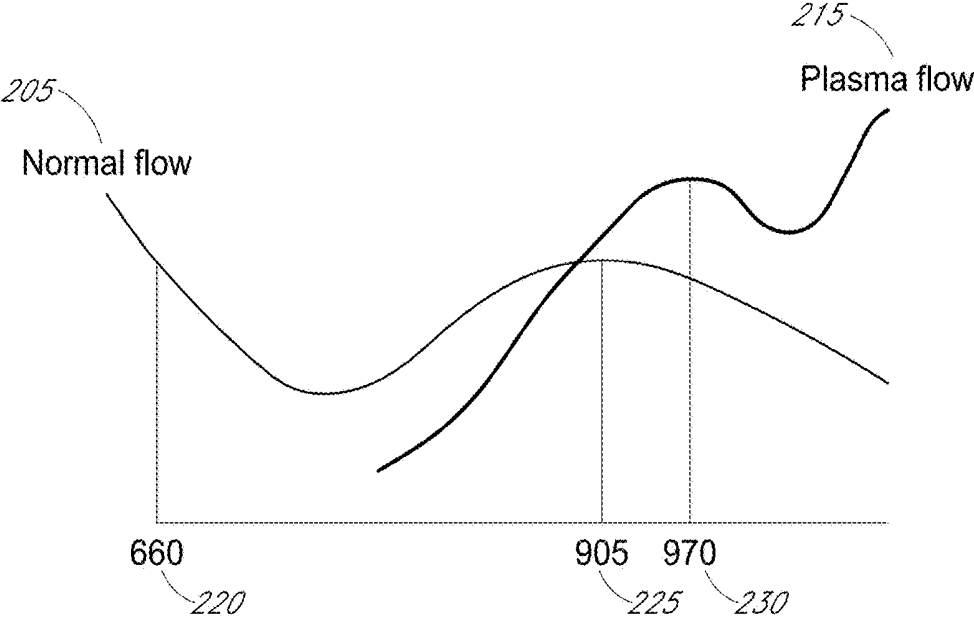

FIG. 2

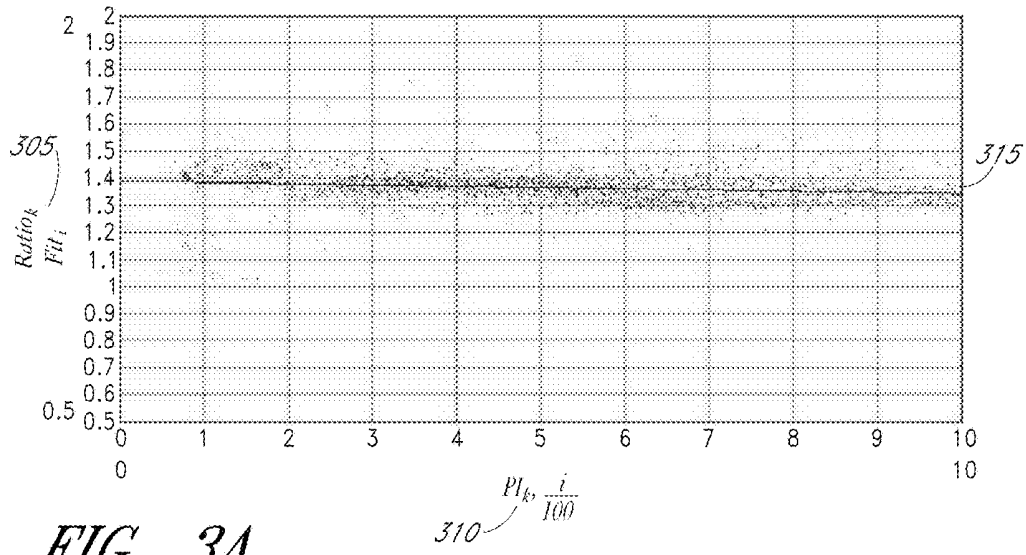

FIG. 3A

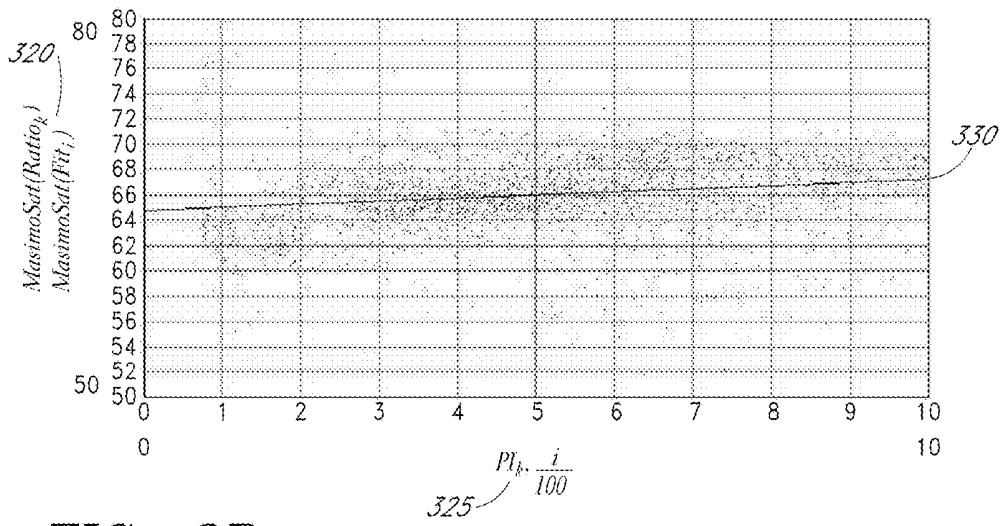

FIG. 3B

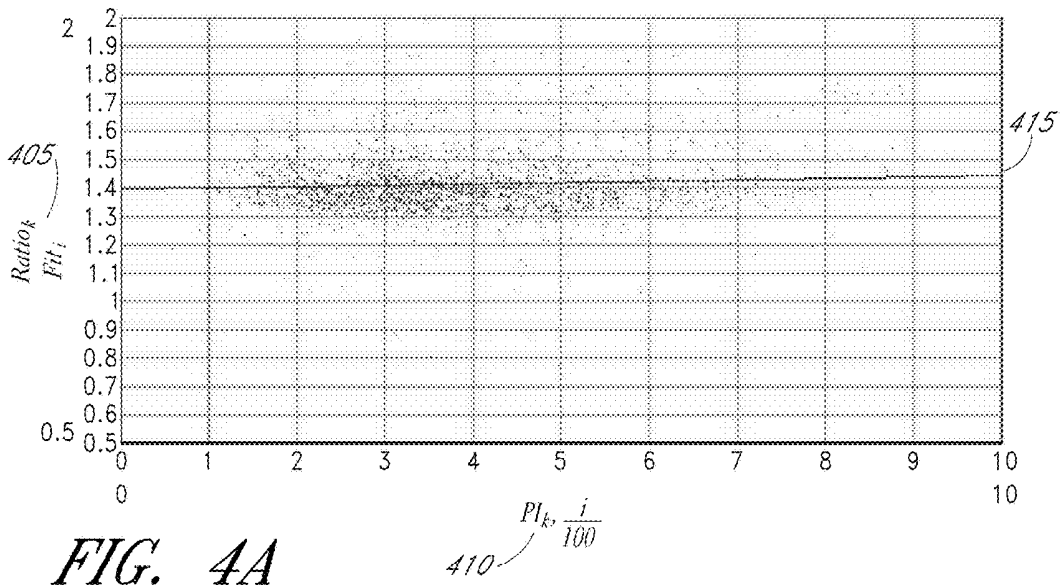

FIG. 4A

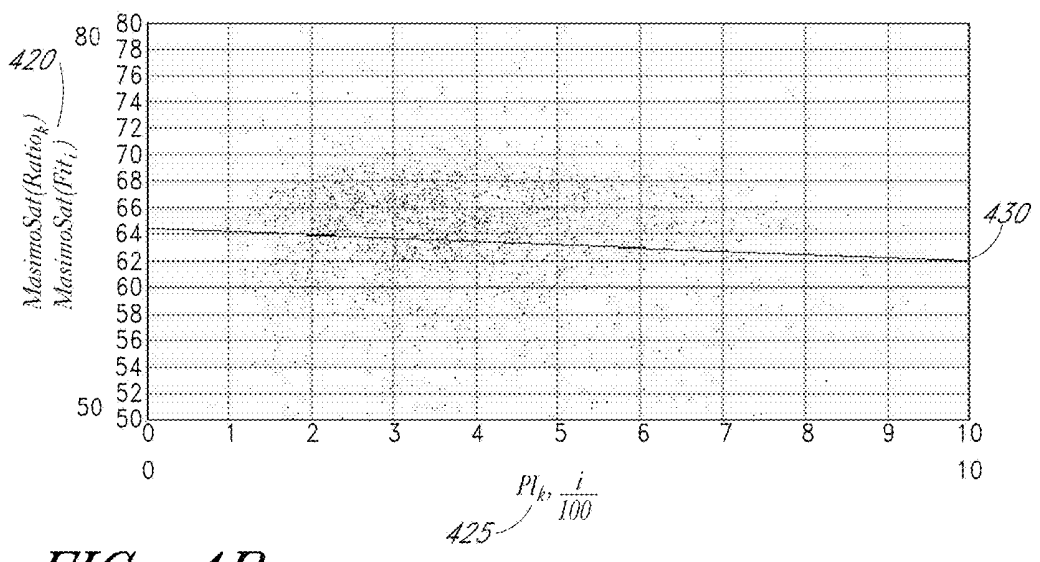

FIG. 4B

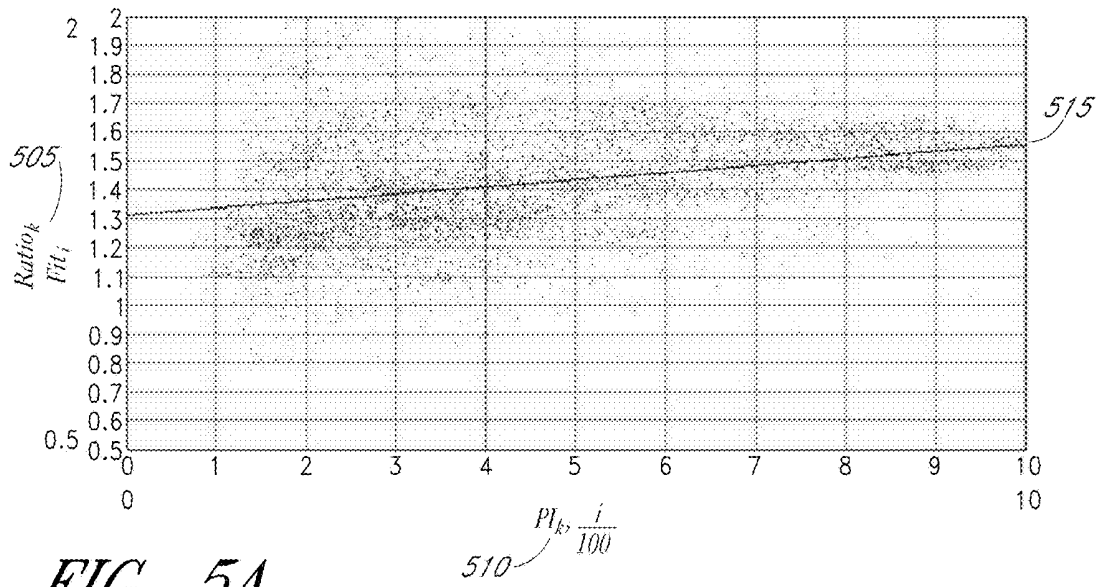

FIG. 5A

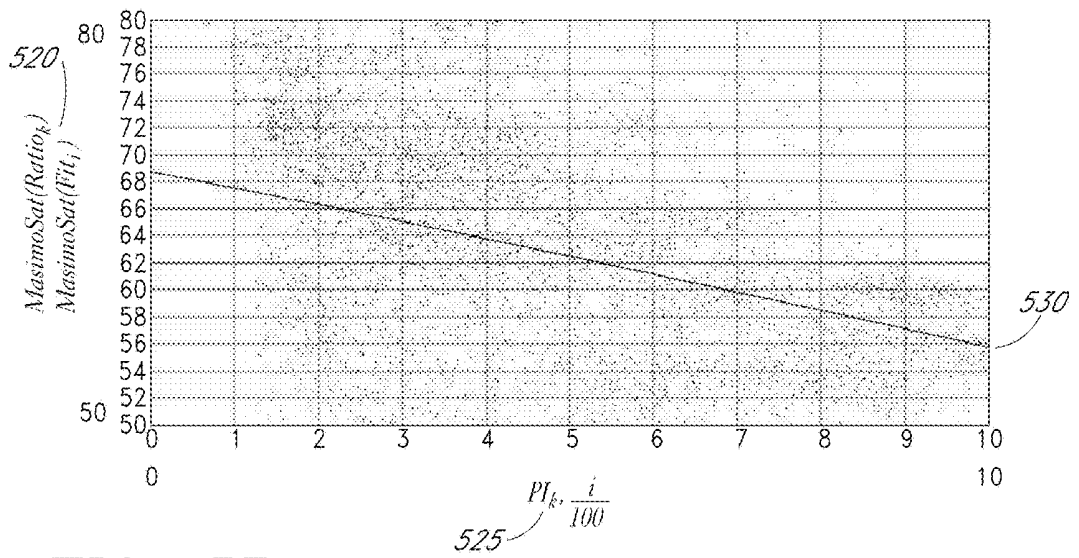

FIG. 5B

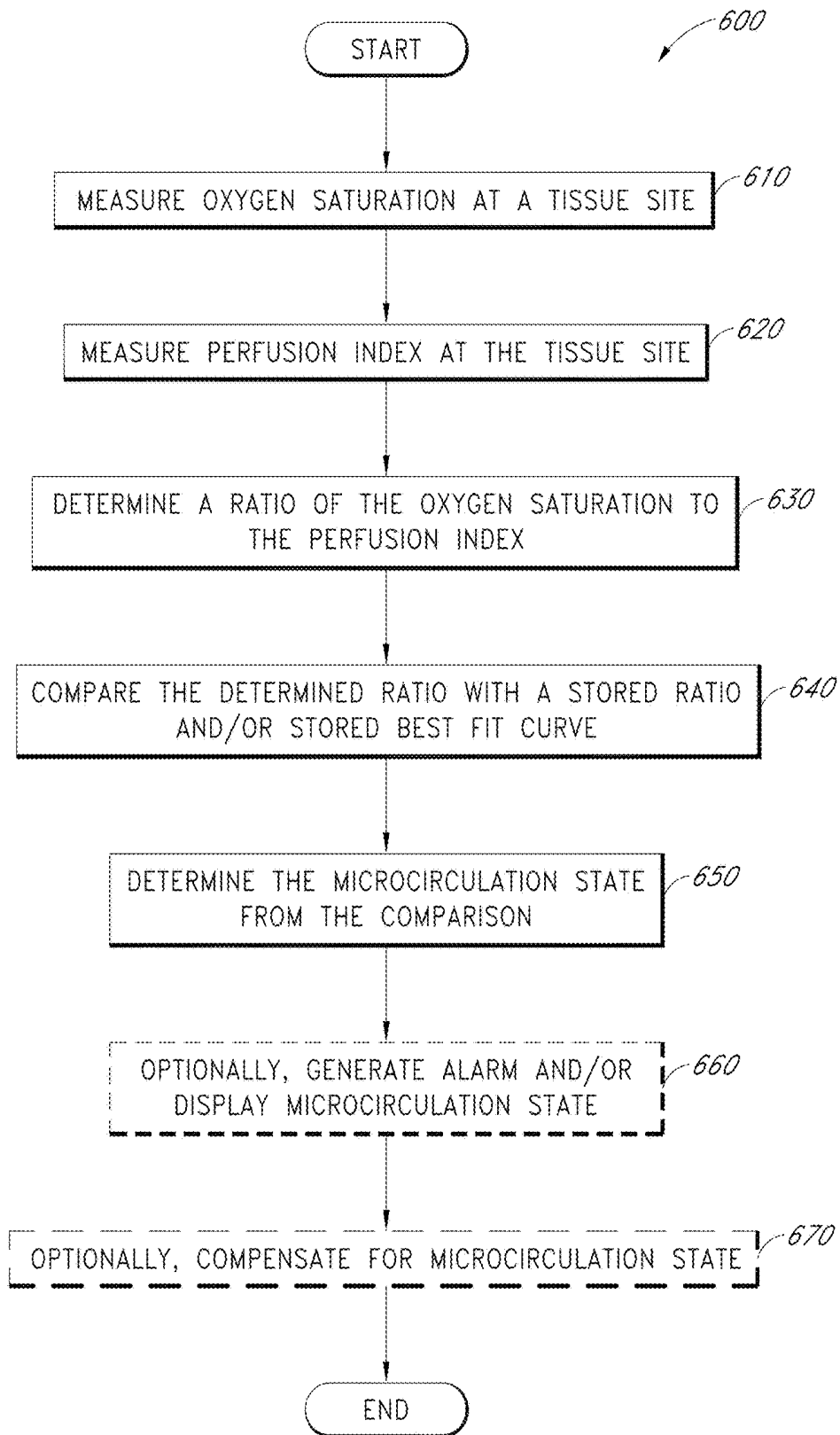

FIG. 6

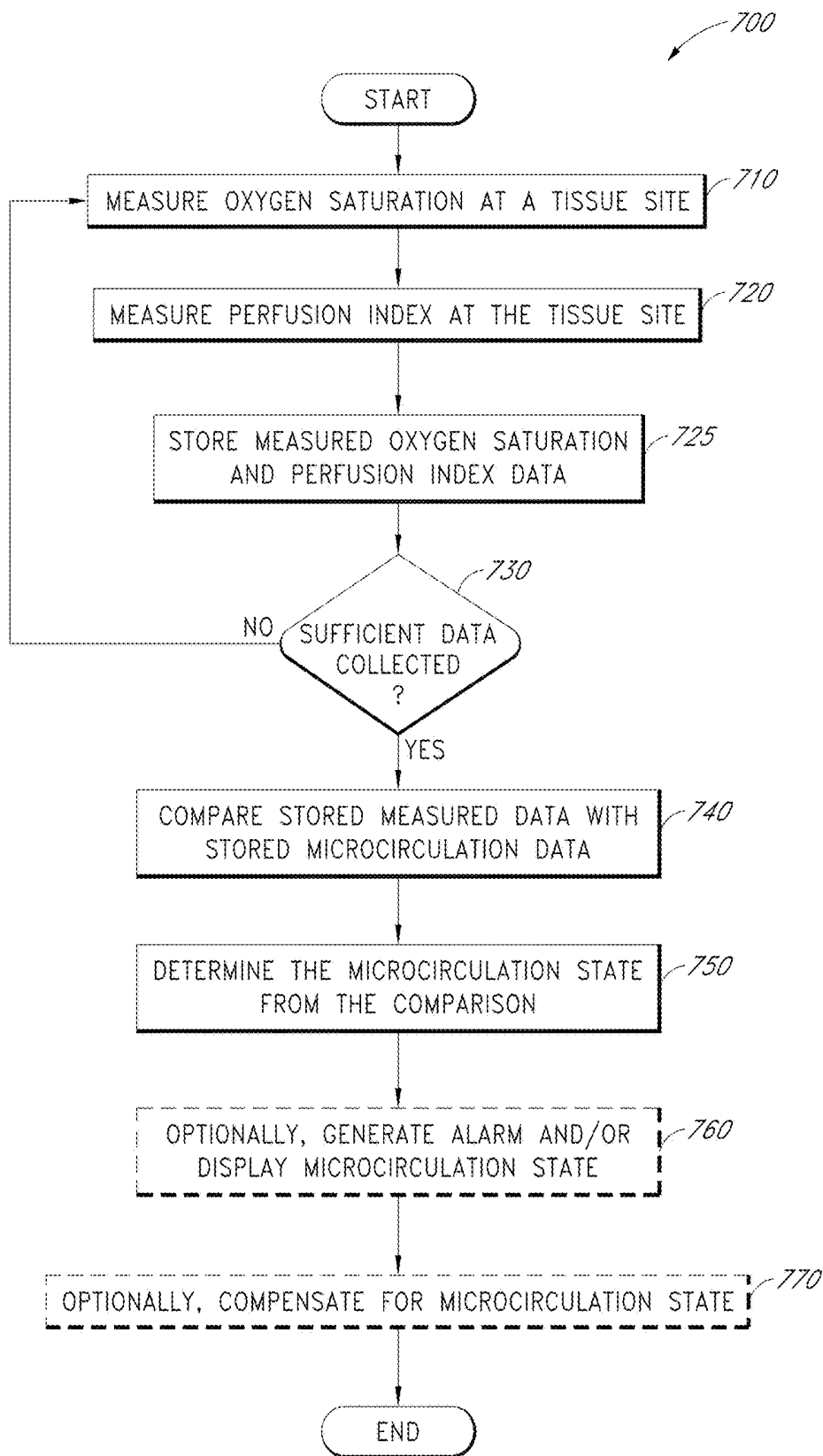

FIG. 7

PATIENT MONITOR FOR DETERMINING MICROCIRCULATION STATE

CROSS-REFERENCE TO RELATED APPLICATIONS

[0001] This application is a continuation of U.S. patent application Ser. No. 14/923,235, filed Oct. 26, 2015, titled PATIENT MONITOR FOR DETERMINING MICROCIRCULATION STATE, which is a continuation of U.S. patent application Ser. No. 14/160,316, filed Jan. 21, 2014, titled PATIENT MONITOR FOR DETERMINING MICROCIRCULATION STATE, which is a continuation of U.S. patent application Ser. No. 13/101,093, filed May 4, 2011, titled PATIENT MONITOR FOR DETERMINING MICROCIRCULATION STATE, which claims the benefit of priority under 35 U.S.C. § 119(e) of U.S. Provisional Application No. 61/332,155, filed May 6, 2010, titled PATIENT MONITOR FOR DETERMINING MICROCIRCULATION STATE, the entire contents of each of which are hereby incorporated by reference herein in their entireties.

FIELD OF THE DISCLOSURE

[0002] The present disclosure relates to medical sensors and specifically to a medical sensor and/or monitor for determining the circulation state in blood vessels.

BACKGROUND OF THE DISCLOSURE

[0003] Patient monitoring of various physiological parameters of a patient is important to a wide range of medical applications. Oximetry is one of the techniques that has developed to accomplish the monitoring of some of these physiological characteristics. It was developed to study and to measure, among other things, the oxygen status of blood. Pulse oximetry—a noninvasive, widely accepted form of oximetry—relies on a sensor attached externally to a patient to output signals indicative of various physiological parameters, such as a patient's constituents and/or analytes, including for example a percent value for arterial oxygen saturation, carbon monoxide saturation, methemoglobin saturation, fractional saturations, total hematocrit, bilirubins, perfusion quality, or the like. A pulse oximetry system generally includes a patient monitor, a communications medium such as a cable, and/or a physiological sensor having light emitters and a detector, such as one or more LEDs and a photodetector. The sensor is attached to a tissue site, such as a finger, toe, ear lobe, nose, hand, foot, or other site having pulsatile blood flow which can be penetrated by light from the emitters. The detector is responsive to the emitted light after attenuation by pulsatile blood flowing in the tissue site. The detector outputs a detector signal to the monitor over the communication medium, which processes the signal to provide a numerical readout of physiological parameters such as oxygen saturation (SpO₂) and/or pulse rate.

[0004] High fidelity pulse oximeters capable of reading through motion induced noise are disclosed in U.S. Pat. Nos. 7,096,054, 6,813,511, 6,792,300, 6,770,028, 6,658,276, 6,157,850, 6,002,952, 5,769,785, and 5,758,644, which are assigned to Masimo Corporation of Irvine, Calif. ("Masimo Corp.") and are incorporated by reference herein. Advanced physiological monitoring systems can incorporate pulse oximetry in addition to advanced features for the calculation and display of other blood parameters, such as carboxyhe-

moglobin (HbCO), methemoglobin (HbMet), total hemoglobin (Hbt), total Hematocrit (Hct), oxygen concentrations, glucose concentrations, blood pressure, electrocardiogram data, temperature, and/or respiratory rate as a few examples. Typically, the physiological monitoring system provides a numerical readout of and/or waveform of the measured parameter. Advanced physiological monitors and multiple wavelength optical sensors capable of measuring parameters in addition to SpO₂, such as HbCO, HbMet and/or Hbt are described in at least U.S. patent application Ser. No. 11/367,013, filed Mar. 1, 2006, titled Multiple Wavelength Sensor Emitters and U.S. patent application Ser. No. 11/366,208, filed Mar. 1, 2006, titled Noninvasive Multi-Parameter Patient Monitor, assigned to Masimo Laboratories, Inc. and incorporated by reference herein. Further, noninvasive blood parameter monitors and optical sensors including Rainbow™ adhesive and reusable sensors and RAD-57™ and Radical-7™ monitors capable of measuring SpO₂, pulse rate, perfusion index (PI), signal quality (SiQ), pulse variability index (PVI), HbCO and/or HbMet, among other parameters, are also commercially available from Masimo Corp.

[0005] During blood circulation, arteries carry blood away from the heart in high volume and under high pressure. Arteries branch off into smaller blood vessels, called arterioles. Arterioles are well innervated, surrounded by smooth muscle cells, and are about 10-100 μm in diameter. Arterioles carry the blood to the capillaries, which are the smallest blood vessels, which are not innervated, have no smooth muscle, and are about 5-8 μm in diameter. Blood flows out of the capillaries into the venules, which have little smooth muscle and are about 10-200 μm in diameter. The blood flows from venules into the veins, which carry blood back to the heart.

[0006] Microcirculation generally refers to the vascular network lying between the arterioles and the venules, including the capillaries, as well as the flow of blood through this network. These small vessels can be found in the vasculature which are embedded within organs and are responsible for the distribution of blood within tissues as opposed to larger vessels in the macrocirculation which transport blood to and from the organs. One of the functions of microcirculation is to deliver oxygen and other nutrients to tissue. Sometimes, microcirculation in these small vessels can become blocked, interfering with the delivery of oxygen to the tissue.

SUMMARY OF THE DISCLOSURE

[0007] As placement of a physiological monitoring sensor is typically at a sensor site located at an extremity of the body, the state of microcirculation, such as whether vessels are blocked or open, can have a significant effect on the readings at the sensor site. It is therefore desirable to provide a patient monitor and/or physiological monitoring sensor capable of distinguishing the microcirculation state of blood vessels. In some embodiments, the patient monitor and/or sensor provide a warning and/or compensates a measurement based on the microcirculation state. In some embodiments, a microcirculation determination process implementable by the patient monitor and/or sensor is used to determine the state of microcirculation of the patient.

BRIEF DESCRIPTION OF THE DRAWINGS

[0008] Throughout the drawings, reference numbers may be re-used to indicate correspondence between referenced

elements. The drawings are provided to illustrate embodiments of the disclosure described herein and not to limit the scope thereof.

[0009] FIG. 1 illustrates a block diagram of a patient monitor, such as a pulse oximeter, and associated sensor;

[0010] FIG. 2 illustrates an example graph depicting the optical absorption characteristic of normal blood and plasma;

[0011] FIGS. 3A and 3B illustrate graphs of oxygen saturation values for a normal microcirculation state data set;

[0012] FIGS. 4A and 4B illustrate graphs of oxygen saturation values for another normal microcirculation state data set;

[0013] FIGS. 5A and 5B illustrate graphs of oxygen saturation values for an anomalous microcirculation state data set;

[0014] FIG. 6 illustrates a flow diagram for a process for determining the state of microcirculation usable by a pulse oximeter; and

[0015] FIG. 7 illustrates a flow diagram for a process for determining the state of microcirculation wherein multiple data points are collected.

DETAILED DESCRIPTION

[0016] FIG. 1 illustrates a block diagram of a patient monitor **100**, such as a pulse oximeter, and associated sensor **110**. Generally, in the case of a pulse oximeter, the sensor **110** has LED emitters **112**, generally one at a red wavelength and one at an infrared wavelength, and a photodiode detector **114**. The sensor **110** is generally attached to an adult patient's finger or an infant patient's foot. For a finger, the sensor **110** is configured so that the emitters **112** project light through the fingernail and through the blood vessels and capillaries underneath. The LED emitters **112** are activated by drive signals **122** from the pulse oximeter **100**. The detector **114** is positioned at the fingertip opposite the fingernail so as to detect the LED emitted light as it emerges from the finger tissues. The photodiode generated signal **124** is relayed by a cable to the pulse oximeter **100**.

[0017] A pulse oximeter **100** determines oxygen saturation (SpO₂) by computing the differential absorption by arterial blood of the two wavelengths emitted by the sensor **110**. A typical pulse oximeter **100** contains a sensor interface **120**, one or more processors **130**, such as a SpO₂ processor, an instrument manager **140**, a display **150**, an audible indicator (tone generator) **160**, and a keypad **170**. The sensor interface **120** provides LED drive current **122** which alternately activates the sensor's red and infrared LED emitters **112**. The sensor interface **120** also has input circuitry for amplification and filtering of the signal **124** generated by the photodiode detector **114**, which corresponds to the red and infrared light energy attenuated from transmission through the patient tissue site. The SpO₂ processor **130** calculates a ratio of detected red and infrared intensities, and an arterial oxygen saturation value is empirically determined based on that ratio. The instrument manager **140** provides hardware and software interfaces for managing the display **150**, audible indicator **160**, and keypad **170**. The display **150** shows the computed oxygen saturation status, as described above. Similarly, other patient parameters including HbCO, HbMet, Hbt, Hct, oxygen concentrations, glucose concentrations, pulse rate, PI, SiQ, and/or PVI can be computed. The audible indicator **160** provides the pulse beep as well as alarms indicating desaturation events. The keypad **170** pro-

vides a user interface for such things as alarm thresholds, alarm enablement, and/or display options.

[0018] Computation of SpO₂ relies on the differential light absorption of oxygenated hemoglobin, HbO₂, and deoxygenated hemoglobin, Hb, to determine their respective concentrations in the arterial blood. Specifically, pulse oximetry measurements are made at red (R) and infrared (IR) wavelengths chosen such that deoxygenated hemoglobin absorbs more red light than oxygenated hemoglobin, and, conversely, oxygenated hemoglobin absorbs more infrared light than deoxygenated hemoglobin, for example 660 nm (R) and 905 nm (IR).

[0019] To distinguish between tissue absorption at the two wavelengths, the red and infrared emitters **112** are provided drive current **122** so that only one is emitting light at a given time. For example, the emitters **112** can be cycled on and off alternately, in sequence, with each only active for a quarter cycle and with a quarter cycle separating the active times. This allows for separation of red and infrared signals and removal of ambient light levels by downstream signal processing. Because only a single detector **114** is used, it responds to both the red and infrared emitted light and generates a time-division-multiplexed ("modulated") output signal **124**. This modulated signal **124** is coupled to the input of the sensor interface **120**.

[0020] In addition to the differential absorption of hemoglobin derivatives, pulse oximetry relies on the pulsatile nature of arterial blood to differentiate hemoglobin absorption from absorption of other constituents in the surrounding tissues. Light absorption between systole and diastole varies due to the blood volume change from the inflow and outflow of arterial blood at a peripheral tissue site. This tissue site might also comprise skin, muscle, bone, venous blood, fat, pigment, and/or the like, each of which absorbs light. It is assumed that the background absorption due to these surrounding tissues is invariant and can be ignored. Thus, blood oxygen saturation measurements are based upon a ratio of the time-varying or AC portion of the detected red and infrared signals with respect to the time-invariant or DC portion: $R/IR = (Red_{AC}/Red_{DC})/(IR_{AC}/IR_{DC})$.

[0021] The desired SpO₂ measurement is then computed from this ratio. The relationship between R/IR and SpO₂ can be determined by statistical regression of experimental measurements obtained from human volunteers and calibrated measurements of oxygen saturation. In a pulse oximeter device, this empirical relationship can be stored as a "calibration curve" in a read-only memory (ROM) look-up table so that SpO₂ can be directly read-out of the memory in response to input R/IR measurements.

[0022] The pulse oximeter **100** can also measure perfusion index, PI, which is a numerical value that indicates the strength of the IR signal returned from a monitoring site and provides a relative assessment of the pulse strength at the monitoring site. The perfusion index can be defined as follows: $PI = (IR_{max} - IR_{min})/IR_{DC}$, where IR_{max} is the maximum value, IR_{min} is the minimum value, and IR_{DC} is the average value of the invariant portion. As the light absorption characteristic of blood is typically "flatter" or less sensitive to oxygen saturation around the infrared wavelength, the infrared signal from a sensor is influenced primarily by the amount of the blood at the monitoring site, not by the level of oxygenation in the blood. Accordingly, the perfusion index, which is a numerical value that indicates the strength of the IR signal returned from a monitor-

ing site, provides a relative assessment of the pulse strength at the monitoring site. PI values generally range from 0.02% (very weak pulse strength) to 20% (very strong pulse strength). In some embodiments, PI can be measured using other wavelengths. For example, red, near red, near IR, as well as other wavelengths can be used.

[0023] In an embodiment, the sensor **110** also includes a memory device **116**. The memory **116** can include any one or more of a wide variety of memory devices known to an artisan from the disclosure herein, including erasable programmable read only memory (EPROM), electrically erasable programmable read-only memory (EEPROM), flash memory, other non-volatile memory, a combination of the same or the like. The memory **116** can include read-only memory such as read-only memory (ROM), a read and write device such as a random-access memory (RAM), combinations of the same, or the like. The remainder of the present disclosure will refer to such combination as simply EPROM for ease of disclosure; however, an artisan will recognize from the disclosure herein that the memory can include ROM, RAM, single wire memory, other types of memory, combinations of the same, or the like.

[0024] The memory device **116** can advantageously store some or all of a wide variety of data and information, including, for example, information on the type or operation of the sensor, type of patient or body tissue, buyer or manufacturer information, sensor characteristics including the number of wavelengths capable of being emitted, emitter specifications, emitter drive requirements, demodulation data, calculation mode data, calibration data, software such as scripts, executable code, or the like, sensor electronic elements, sensor life data indicating whether some or all sensor components have expired and should be replaced, encryption information, monitor or algorithm upgrade instructions or data, or the like. In an embodiment, the memory device can also include oxygen saturation to perfusion index and R/IR ratio to perfusion index ratios and/or data.

[0025] In certain situations, pulse oximetry sensors may produce anomalous readings, such as when a patient suffers from cyanosis. In a patient suffering from cyanosis, blood cells are uncharacteristically low on oxygen, leading to oxygen deficiency and giving the patient's skin a bluish-hue. One potential cause is that the patient's body produces too much hemoglobin, making the blood "thicker" or slower flowing, making microcirculation vessels more prone to blockage. Thus, a "blocked" microcirculation state can indicate cyanosis.

[0026] A "blocked" microcirculation state can also indicate other medical conditions, such as sepsis, systemic inflammatory response syndrome (SIRS), or septicemia. Sepsis is a potentially deadly medical condition that is characterized by a whole-body inflammatory state (called SIRS) and the presence of a known or suspected infection. The body may develop this inflammatory response by the immune system to microbes in the blood, urine, lungs, skin, or other tissue. Septicemia is a related medical term referring to the presence of pathogenic organisms in the bloodstream, which can lead to sepsis. Sepsis can also be referred to as blood poisoning. During sepsis or SIRS, inflammation in the body can cause constriction in blood vessels, leading to low blood pressure or insufficient blood flow.

[0027] During a "blocked" microcirculation state, blood cells can get blocked in the microcirculation vessels, such as

the arterioles and capillaries. Blood cells can clump together or otherwise catch against the wall of blood vessels, creating a blockage that prevents blood cells, including red blood cells carrying hemoglobin, from passing through the blockage. However, plasma, which is composed of mostly water and in which the blood cells are suspended, is generally able to flow through passages in the blockage. In some situations, some blood vessels at the monitoring site may continue to have normal flow while some vessels are blocked. Thus, a "blocked" microcirculation state can indicate that some microcirculation vessels in an area are blocked and not necessarily all vessels in the area are blocked.

[0028] With the blockage preventing most or all the red blood cells from passing a blood vessel, at most only a limited amount of hemoglobin passes through a blocked blood vessel. In some situations, the blood vessel may only be partially blocked, where some hemoglobin passes through but less than when the blood vessel is unblocked. Normally, blood is made up of about 40-50% of red blood cells, of which about 95% is hemoglobin. Plasma, which is about 95% water, normally constitutes about 55% of the blood's volume.

[0029] Accordingly, a pulse oximeter placed on a tissue site experiencing blockage in microcirculation vessels may detect mostly plasma passing through with no or only a small percentage of red blood cells, at least at part of the monitoring site. The resulting change in the normal composition of blood can cause anomalous readings in the pulse oximetry monitor. As plasma has generally different absorption characteristics for red and infrared wavelengths than normal blood, pulse oximetry readings may become skewed. Red_{AC} and/or IR_{AC} can be affected, causing measured R/IR ratio to change. For example, if Red_{AC} rises or IR_{AC} drops, the R/IR ratio increases. Alternatively, if Red_{AC} drops or IR_{AC} rises, the R/IR ratio decreases. Thus, the value of R/IR can change due to a change in the light absorption of blood even if the underlying oxygen saturation of the blood remains the same.

[0030] However, by comparing oxygen saturation and PI for normal microcirculation to the oxygen saturation and PI for blocked microcirculation, such as by calculating and comparing ratios, the monitor can determine the existence of an abnormal situation. Typically, SpO₂ is mostly independent of PI, with SpO₂ varying minimally as PI increases. However, SpO₂ varying by more than normal as PI increases can indicate an anomalous microcirculation state, such as a blockage. In one embodiment, by analyzing the measured ratios, the pulse oximeter **100** can determine the microcirculation state, such as whether a blocked vessel exists in the microcirculation vessels.

[0031] FIG. 2 illustrates an example graph depicting the optical absorption characteristic of normal blood and plasma. The graph depicts sampling wavelengths at 660 nm **220** and at 905 nm **225**. As illustrated, IR absorption for plasma at a frequency of 905 nm is on a "steeper" section of the curve compared to the "flatter" section of the curve for normal blood. This can imply that readings for IR for plasma would be more sensitive to changes in the absorption quality of the blood. In contrast, the IR measurement for normal blood, for example at 905 nm, is usually insensitive to a change in oxygenation of normal blood, but more affected by change in the amount of blood. As illustrated in the graph, plasma can have a "flatter" section in its absorption curve at a different wavelength, for example at 970 nm **230**.

[0032] FIGS. 3A and 3B illustrate graphs of oxygen saturation values for a normal microcirculation state data set. FIG. 3A has a y-axis 305 corresponding to the measured ratio, R/IR, and a x-axis 310 corresponding to perfusion index, PI. FIG. 3B has a y-axis 320 corresponding to measured oxygen saturation, and an x-axis 325 corresponding to perfusion index, PI. FIGS. 3A and 3B represent multiple data points with a best fit line 315, 330 indicating the trend of the data points. Each data point represents a measurement. As illustrated, the best fit line for FIG. 3A trends slightly downward and the best fit line for FIG. 3B trends slightly upwards. However, there is generally only a small change in the y-axis for the best fit line as PI increases, with the change in FIG. 3A around 0.1 and the change in FIG. 3B around 4.

[0033] FIGS. 4A and 4B illustrate graphs of oxygen saturation values for another normal microcirculation state data set. FIG. 4A has a y-axis 405 corresponding to the measured ratio, R/IR, and an x-axis 410 corresponding to perfusion index, PI. FIG. 4B has a y-axis 420 corresponding to measured oxygen saturation, and an x-axis 425 corresponding to perfusion index, PI. FIGS. 4A and 4B represent multiple data points with a best fit line 415, 430 indicating the trend of the data points. Each data point represents a measurement. As illustrated, the best fit line for FIG. 4A trends slightly upwards and the best fit line for FIG. 4B trends slightly downwards. However, there is generally only a small change in the y-axis for the best fit line as PI increases, with the change in FIG. 4A around 0.1 and the change in FIG. 4B around 3.

[0034] FIGS. 5A and 5B illustrate graphs of oxygen saturation values for an anomalous microcirculation state data set. FIG. 5A has a y-axis 505 corresponding to the measured ratio, R/IR, and an x-axis 510 corresponding to perfusion index, PI. FIG. 5B has a y-axis 520 corresponding to measured oxygen saturation, and an x-axis 525 corresponding to perfusion index, PI. FIGS. 5A and 5B represent multiple data points with a best fit line 515, 530 indicating the trend of the data points. Each data point represents a measurement. As illustrated, the best fit line for FIG. 5A trends significantly upwards on the y-axis by around 0.3 and the best fit line for FIG. 5B trends significantly downwards on the y-axis by around 13 as PI increases.

[0035] In comparison to FIGS. 3A and 4A, FIG. 5A shows a high R/IR ratio for low values of PI that becomes a high R/IR ratio as PI increases. In comparison to FIGS. 3B and 4B, FIG. 5B shows a high reading for low values of PI that becomes a low reading as PI increases. Differences between the graphs can be explained by the microcirculation state in FIGS. 5A and 5B being different from the microcirculation state in FIGS. 3A-4B. For example, FIGS. 5A and 5B can represent a "blocked" or partially blocked microcirculation state where the blood passing through the sensor includes mostly plasma. As discussed above, this can skew R/IR and the measured oxygen saturation derived from R/IR.

[0036] FIG. 6 illustrates a flow diagram for a process 600 for determining the state of microcirculation usable by a pulse oximeter. Microcirculation state can be determined by comparison with microcirculation data stored on a patient monitor, such as the pulse oximeter 100 of FIG. 1. The process 600 can be implemented by embodiments of the sensor 110 and/or patient monitor 100 of FIG. 1 or other suitable device.

[0037] While in conventional pulse oximetry, measurements are generally taken pulse-by-pulse and averaged over pulses, microcirculation measurements can be measured using only a single pulse or a portion of a single pulse. This can be done, for example, at the minimum and/or maximum blood flow of a pulse. Microcirculation measurements can also be determined over multiple pulses. In some embodiments, microcirculation measurements are taken during a portion of the normal measurement time used by a physiological sensor to take a measurement of a parameter, thereby allowing detection of aberrant parameter measurements using the microcirculation measurements. For example, while a pulse oximeter is measuring SpO2 over several pulses, microcirculation measurements can be taken per pulse and a warning given if an irregular microcirculation state is detected, thereby notifying a user of a possible aberration in the current SpO2 reading.

[0038] At block 610, oxygen saturation is measured at a tissue monitoring site. In one embodiment, oxygen saturation is determined using a pulse oximeter sensor.

[0039] At block 620, perfusion index or pulse strength is measured. In one embodiment, the perfusion index is determined using the same sensor used to measure oxygen saturation so that readings are taken at the same monitoring site.

[0040] At block 630, a ratio of oxygen saturation to perfusion index is determined. Oxygen saturation can be a SpO2 value based on the measured R/IR ratio looked-up against a calibration curve. Alternatively, the ratio can be perfusion index to oxygen saturation. In other embodiments, the measured R/IR ratio can be used directly instead of SpO2.

[0041] In some embodiments, multiple readings of perfusion index and oxygen saturation can be taken and averaged together before determining the ratio in order to account for outliers. The multiple readings can be filtered before averaging. For example, readings can first be filtered based on closeness of PI values before the readings are averaged together.

[0042] At block 640, the determined ratio in block 630 is compared to stored microcirculation data. The stored data can be data sets for microcirculation states. In some embodiments, a ratio, a curve, a line, table, data points, or formula can be stored that corresponds to a data set. The measured perfusion index and oxygen saturation can then be compared to the stored data. In some embodiments, multiple readings are taken and a best fit line or curve is generated and compared to a stored best fit line or curve. In some embodiments, readings are collected at various PI values in order to generate a trend line.

[0043] At block 650, the microcirculation state is determined from comparison of the stored microcirculation data. For example, if the determined ratio is similar to a stored ratio corresponding to a data set for unblocked microcirculation, the microcirculation state is determined to be unblocked. Other data sets for other microcirculation states, such as blocked and/or partially blocked can also be stored. Where multiple data sets are stored, the state can be determined by selecting the state corresponding to the stored ratio closest to the measured ratio.

[0044] At block 660, the monitor can optionally generate an alarm and/or display the microcirculation state. For example, an alarm signal can be generated by the monitor to indicate that the readings may be anomalous, such as when

a blocked or partially blocked microcirculation state is detected. The alarm can be a visual indicator (e.g., icon, message or image) and/or an audio indicator. In an embodiment, the alarm can indicate the detection of cyanosis, sepsis, SIRS or other medical condition based at least partly on the determined microcirculation state. In some situations, no action is taken, such as when readings are determined to be normal or non-threatening.

[0045] At block 670, the monitor can optionally compensate for the microcirculation state in order to improve accuracy of the readings. After the microcirculation state returns to normal, the compensation process can be ended.

[0046] In one embodiment, an offset can be added to the measured parameter value, such as SpO₂. The offset can be calculated based on data sets for microcirculation state. Different microcirculation states can have different offsets. For example, if a “blocked” microcirculation state produces high readings for low PI values, a negative offset can be used. However, if a “blocked” state produces a low value for high PI values, then a positive offset can be used. In one embodiment, a varying offset can be used depending on the value of PI.

[0047] In one embodiment, a different wavelength emitter can be used to compensate for a microcirculation state. For example, rather than using a regular infrared emitter, typically 905 nm, an emitter with a different infrared wavelength, such as 970 nm can be used. In one embodiment, the different wavelength is selected such that the wavelength is at a “flat” section of the light absorption curve for plasma, that is, where the light absorption is not much affected by changes in oxygen saturation. In one embodiment, the selected wavelength with regards to plasma mimics the properties of the regular wavelength with regards to normal flowing blood. In some embodiments, a different wavelength red emitter can be used instead of the regular red wavelength emitter.

[0048] In some embodiments, the pulse oximeter sensor used to measure oxygen saturation and PI can be provided with an additional emitter at a different wavelength than the existing emitters. When a certain microcirculation state is detected, such as a “blocked” state, the additional emitter can be used. For example, a pulse oximetry sensor can be equipped with LED’s capable of emitting at 660 nm, 905 nm, and at 970 nm wavelengths. Under normal operation, the 660 nm and 905 nm emitters are active. However, upon detecting a blocked microcirculation state, the 905 nm emitter can be deactivated and the 970 nm emitter activated in its place. In some embodiments, a variable wavelength emitter can be used rather than separate emitters. In some embodiments, the additional emitter can be a red wavelength emitter.

[0049] FIG. 7 illustrates a flow diagram for a process 700 for determining the state of microcirculation wherein multiple data points are collected. The process 700 can be implemented by embodiments of the sensor 110 and/or patient monitor 100 of FIG. 1 or other suitable device.

[0050] At block 710 and block 720, oxygen saturation and perfusion index are measured. At block 725, measured values are stored in memory. Each paired measurement forms a data point.

[0051] At block 730, the number of stored data points is checked to determine if sufficient data has been collected to determine the microcirculation state. Data can be sufficient if a set number of data points have been collected, a set

amount of time has passed, and/or a spectrum of data points have been collected, such as for differing values of PI.

[0052] At block 740, the stored measured data is compared with stored microcirculation data. Typically, the microcirculation data is pre-stored on the pulse oximeter before use, as opposed to collected during use. A comparison can involve generating a curve or line from the measured data, calculating a rate of change for the stored data, generating a trend line for the measured data or the like and comparing with the stored microcirculation data.

[0053] At block 750, the microcirculation state is determined from comparison of the stored microcirculation data. For example, if the measured data is similar to microcirculation data corresponding to a data set for unblocked microcirculation, the microcirculation state is determined to be unblocked. Other data sets for other microcirculation states, such as for blocked and/or partially blocked can also be stored. Where multiple data sets are stored, the state can be determined by selecting the state corresponding to the stored ratio closest to the measured ratio.

[0054] Blocks 760 and 770 are similar to steps 660 and 670 described in FIG. 6.

[0055] As will be apparent from the above description, the R/IR ratio corresponds to oxygen saturation or SpO₂ and can be used in place of oxygen saturation or SpO₂ for the above comparisons, and vice versa.

[0056] While the above systems and methods have been described in terms of oxygen saturation and PI, other physiological parameters can be measured in place of or in addition to oxygen saturation and/or perfusion index and used to determine microcirculation state. For example, perfusion index is an indication of amplitude and/or signal strength and other parameters or measurements indicating amplitude and/or signal strength can be used. In some embodiments, one or more different sensors can be used in place of or in addition to a pulse oximeter sensor.

[0057] Conditional language used herein, such as, among others, “can,” “could,” “might,” “may,” “e.g.,” and the like, unless specifically stated otherwise, or otherwise understood within the context as used, is generally intended to convey that certain embodiments include, while other embodiments do not include, certain features, elements and/or states. Thus, such conditional language is not generally intended to imply that features, elements and/or states are in any way required for one or more embodiments or that one or more embodiments necessarily include logic for deciding, with or without author input or prompting, whether these features, elements and/or states are included or are to be performed in any particular embodiment. The terms “comprising,” “including,” “having,” and the like are synonymous and are used inclusively, in an open-ended fashion, and do not exclude additional elements, features, acts, operations, and so forth. Also, the term “or” is used in its inclusive sense (and not in its exclusive sense) so that when used, for example, to connect a list of elements, the term “or” means one, some, or all of the elements in the list.

[0058] Various systems and processes for determining microcirculation state have been disclosed in detail in connection with various embodiments. These embodiments are disclosed by way of examples only and are not to limit the scope of the claims that follow. Indeed, the novel methods and systems described herein can be embodied in a variety of other forms; furthermore, various omissions, substitutions and changes in the form of the methods and systems

described herein can be made without departing from the spirit of the inventions disclosed herein. The claims and their equivalents are intended to cover such forms or modifications as would fall within the scope and spirit of certain of the inventions disclosed herein. One of ordinary skill in the art will appreciate the many variations, modifications and combinations. For example, the various embodiments of the microcirculation determination process can be used with other oxygen saturation sensors and with both disposable and reusable sensors. In some embodiments, the determination process can be applied to other blood vessels to detect a blockage, even in vessels not involved in microcirculation.

[0059] Furthermore, in certain embodiments, the systems and methods described herein can advantageously be implemented using computer software, hardware, firmware, or any combination of software, hardware, and firmware. In one embodiment, the system includes a number of software modules that comprise computer executable code for performing the functions described herein. In certain embodiments, the computer-executable code is executed on one or more general purpose computers or processors. However, a skilled artisan will appreciate, in light of this disclosure, that any module that can be implemented using software can also be implemented using a different combination of hardware, software or firmware. For example, such a module can be implemented completely in hardware using a combination of integrated circuits. Alternatively or additionally, such a module can be implemented completely or partially using specialized computers or processors designed to perform the particular functions described herein rather than by general purpose computers or processors.

[0060] Moreover, certain embodiments of the invention are described with reference to methods, apparatus (systems) and computer program products that can be implemented by computer program instructions. These computer program instructions can be provided to a processor of a general purpose computer, special purpose computer, or other programmable data processing apparatus to produce a machine, such that the instructions, which execute via the processor of the computer or other programmable data processing apparatus, create means for implementing the acts specified herein to transform data from a first state to a second state.

[0061] Each of the processes, methods, and algorithms described in the preceding sections may be embodied in, and fully or partially automated by, code modules executed by one or more computers or computer processors. The code modules may be stored on any type of non-transitory computer-readable medium or computer storage device, such as hard drives, solid state memory, optical disc, and/or the like. The processes and algorithms may be implemented partially or wholly in application-specific circuitry. The results of the disclosed processes and process steps may be stored, persistently or otherwise, in any type of non-transitory computer storage such as, e.g., volatile or non-volatile storage.

[0062] The various features and processes described above may be used independently of one another, or may be combined in various ways. All possible combinations and subcombinations are intended to fall within the scope of this disclosure. In addition, certain method or process blocks may be omitted in some implementations. The methods and processes described herein are also not limited to any particular sequence, and the blocks or states relating thereto can be performed in other sequences that are appropriate.

For example, described blocks or states may be performed in an order other than that specifically disclosed, or multiple blocks or states may be combined in a single block or state. The example blocks or states may be performed in serial, in parallel, or in some other manner. Blocks or states may be added to or removed from the disclosed example embodiments. The example systems and components described herein may be configured differently than described. For example, elements may be added to, removed from, or rearranged compared to the disclosed example embodiments.

[0063] While certain example embodiments have been described, these embodiments have been presented by way of example only, and are not intended to limit the scope of the inventions disclosed herein. Thus, nothing in the foregoing description is intended to imply that any particular feature, characteristic, step, module, or block is necessary or indispensable. Indeed, the novel methods and systems described herein may be embodied in a variety of other forms; furthermore, various omissions, substitutions and changes in the form of the methods and systems described herein may be made without departing from the spirit of the inventions disclosed herein. The accompanying claims and their equivalents are intended to cover such forms or modifications as would fall within the scope and spirit of certain of the inventions disclosed herein.

1. (canceled)

2. A patient monitor configured to monitor a patient and determine a microcirculation condition of the patient, the patient monitor comprising:

a sensor interface configured to receive a signal from a physiological sensor that is configured to transmit light of at least a first wavelength and a second wavelength into tissue of a patient and to detect the light after it has been attenuated by the tissue, wherein the signal is responsive to the detected light; and

one or more processors configured to:

process the signal to determine at least:

a measure of oxygen saturation of the tissue of the patient, and

an other calculated parameter responsive to a physiological characteristic of the tissue of the patient;

determine a relationship between the measure of oxygen saturation and the other calculated parameter;

compare the determined relationship with at least some of a plurality of previously determined data sets, wherein the previously determined data sets indicate microcirculation conditions associated with different relationships between measures of oxygen saturation and other calculated parameters; and

responsive to determining, based on said comparing, that a microcirculation condition of the patient comprises an at least partially blocked microcirculation condition in at least a portion of blood vessels in the tissue of the patient, perform at least one of:

provide an electronic microcirculation condition indication for review by a caregiver,

cause the physiological sensor to be configured to transmit at least a portion of the light at a different wavelength, or

apply an offset of to at least one of the measure of oxygen saturation or the other calculated parameter to compensate for the at least partially blocked microcirculation condition.

3. The patient monitor of claim 2, wherein the one or more processors are further configured to:

determine that the microcirculation condition is indicative of cyanosis and/or sepsis; and
in response to determining that the microcirculation condition is indicative of cyanosis and/or sepsis, provide the electronic microcirculation indication.

4. The patient monitor of claim 2, wherein the other calculated parameter comprises a measure of perfusion or perfusion index of the tissue of the patient.

5. The patient monitor of claim 4, wherein determining the relationship comprises:

determining a ratio of the measure of oxygen saturation to the measure of perfusion or perfusion index.

6. The patient monitor of claim 5, wherein comparing the determined relationship with at least some of the plurality of previously determined data sets comprises:

comparing the ratio with at least some of the plurality of previously determined data sets.

7. The patient monitor of claim 5, wherein the plurality of previously determined data sets comprise a plurality of lookup curves, and wherein comparing the determined relationship with at least some of the plurality of previously determined data sets further comprises:

generating a trend line based on the ratio and one or more other ratios determined based on further measures of oxygen saturation and perfusion or perfusion index obtained a different times; and

comparing the trend line to at least one lookup curve of the plurality of lookup curves.

8. The patient monitor of claim 2, wherein comparing the determined relationship with at least some of the plurality of previously determined data sets comprises:

determining one of the plurality of previously determined data sets that is most similar to the determined relationship.

9. The patient monitor of claim 2, wherein the oxygen saturation is responsive to differential absorption of hemoglobin derivatives.

10. The patient monitor of claim 2, wherein the at least partially blocked microcirculation condition indicates an at least partial blockage of hemoglobin.

11. The patient monitor of claim 2 further comprising:

a memory storing the plurality of previously determined data sets, wherein:

at least some of the previously determined data sets indicate relationships between measures of oxygen saturation and the other calculated parameter that correspond to an at least partially blocked microcirculation condition, and

at least some of the previously determined data sets indicate relationships between measures of oxygen saturation and the other calculated parameter that correspond to an unblocked microcirculation condition.

12. A method of monitoring a patient and non-invasively determining a microcirculation condition of the patient, the method comprising:

receiving, from a non-invasive physiological sensor at a tissue site of a patient, a signal responsive to light of at least at first wavelength and a second wavelength that is transmitted by non-invasive physiological sensor and detected by the non-invasive physiological sensor after attenuation by tissue of the patient;

processing the signal to determine at least:

a measure of oxygen saturation of the tissue of the patient, and

an other calculated parameter responsive to a physiological characteristic of the tissue of the patient;

determining a relationship between the measure of oxygen saturation and the other calculated parameter;

comparing the determined relationship with at least some of a plurality of previously determined and stored relationships between measures of oxygen saturation and other calculated parameters, wherein:

at least some of the previously determined relationships correspond to an at least partially blocked microcirculation condition, and

at least some of the previously determined relationships correspond to an unblocked microcirculation condition; and

responsive to determining, based on said comparing, that a the microcirculation condition of the patient comprises an at least partially blocked microcirculation condition in at least a portion of blood vessels in the tissue of the patient, perform at least one of:

providing an electronic microcirculation condition indication for review by a caregiver,

causing the non-invasive physiological sensor to be configured to transmit at least a portion of the light at a different wavelength, or

applying an offset of to at least one of the measure of oxygen saturation or the other calculated parameter to compensate for the at least partially blocked microcirculation condition.

13. The method of claim 12, wherein the other calculated parameter comprises a measure of perfusion or perfusion index of the tissue of the patient.

14. The method of claim 13, wherein determining the relationship comprises:

determining a ratio of the measure of oxygen saturation to the measure of perfusion or perfusion index.

15. The method of claim 14, wherein comparing the determined relationship with at least some of the plurality of previously determined relationships:

comparing the ratio with at least some of the plurality of previously determined relationships.

16. The method of claim 14, wherein the plurality of previously determine relationships comprise a plurality of lookup curves, and wherein comparing the determined relationship with at least some of the plurality of previously determined relationships comprises:

generating a trend line based on the ratio and one or more other ratios determined based on further measures of oxygen saturation and perfusion or perfusion index obtained a different times; and

comparing the trend line to at least one lookup curve of the plurality of lookup curves.

17. The method of claim 12, wherein comparing the determined relationship with at least some of the plurality of previously determined relationships comprises:

determining one of the plurality of previously determined relationships that is most similar to the determined relationship.

18. The method of claim 12, wherein the oxygen saturation is responsive to differential absorption of hemoglobin

derivatives, and wherein the at least partially blocked microcirculation condition indicates an at least partial blockage of hemoglobin.

19. A method of monitoring a patient and non-invasively determining a microcirculation condition of the patient, the method comprising:

receiving, from a non-invasive physiological sensor at a tissue site of a patient, a signal responsive to light of at least at first wavelength and a second wavelength that is transmitted by non-invasive physiological sensor and detected by the non-invasive physiological sensor after attenuation by tissue of the patient;

processing the signal to determine at least:

a first measure of oxygen saturation of the tissue of the patient at a first time,

a first other calculated parameter responsive to a physiological characteristic of the tissue of the patient at the first time,

a second measure of oxygen saturation of the tissue of the patient at a second time different from the first time, and

a second other calculated parameter responsive to a physiological characteristic of the tissue of the patient at the second time;

determining a first relationship between the first measure of oxygen saturation and the first other calculated parameter;

determining a second relationship between the second measure of oxygen saturation and the second other calculated parameter;

comparing the determined first and second relationships with at least some of a plurality of previously determined and stored relationships between measures of oxygen saturation and other calculated parameters, wherein:

at least some of the previously determined relationships correspond to an at least partially blocked microcirculation condition, and

at least some of the previously determined relationships correspond to an unblocked microcirculation condition; and

responsive to determining, based on said comparing, that a microcirculation condition of the patient comprises an at least partially blocked microcirculation condition in at least a portion of blood vessels in the tissue of the patient, perform at least one of:

providing an electronic microcirculation condition indication for review by a caregiver,

causing the non-invasive physiological sensor to be configured to transmit at least a portion of the light at a different wavelength, or

applying an offset of to at least one of the first measure of oxygen saturation, the second measure of oxygen saturation, the first other calculated parameter, or the second other calculated parameter to compensate for the at least partially blocked microcirculation condition.

20. The method of claim **19**, wherein:

determining the first and second relationships includes: averaging the respective first and second measures of oxygen saturation to determine an average measure of oxygen saturation;

averaging the respective first and second other calculated parameters to determine an average other calculated parameter; and

determining a ratio of the average measure of the other calculated parameter to the average measure of oxygen saturation; and

wherein comparing the determined first and second relationships with at least some of the plurality of previously determined and stored relationships includes:

comparing the ratio with at least some of the plurality of previously determined relationships.

21. The method of claim **19**,

wherein determining the first and second relationships includes:

determining respective ratios of the respective first and second other calculated parameters to the respective first and second measures of oxygen saturation; and

wherein comparing the determined first and second relationships with at least some of the plurality of previously determined and stored relationships includes:

comparing the ratios to at least one lookup curve of the plurality of previously determined relationships.

22. The method of claim **19**, wherein comparing the determined first and second relationships with at least some of the plurality of previously determined relationships comprises:

determining one of the plurality of previously determined relationships that is most similar to at least one of the first or second determined relationships.

23. The method of claim **19**, wherein the oxygen saturation is responsive to differential absorption of hemoglobin derivatives, and wherein the at least partially blocked microcirculation condition indicates an at least partial blockage of hemoglobin.

* * * * *

专利名称(译)	用于确定微循环状态的患者监测器		
公开(公告)号	US20180055385A1	公开(公告)日	2018-03-01
申请号	US15/709189	申请日	2017-09-19
[标]申请(专利权)人(译)	梅西莫股份有限公司		
申请(专利权)人(译)	Masimo公司		
当前申请(专利权)人(译)	Masimo公司		
[标]发明人	AL ALI AMMAR		
发明人	AL-ALI, AMMAR		
IPC分类号	A61B5/026 A61B5/00 A61B5/02 A61B5/1455 A61B5/024		
CPC分类号	A61B5/7275 A61B5/0261 A61B5/14552 A61B5/7282 A61B5/02427 A61B5/14551 A61B5/6801 A61B5/02007 A61B5/746		
优先权	61/332155 2010-05-06 US		
其他公开文献	US10271748		
外部链接	Espacenet USPTO		

摘要(译)

由于生理监测传感器的放置通常位于位于身体末端的传感器位置处，微循环状态（例如血管是否被阻塞或打开）可对传感器部位处的读数产生显著影响。因此，希望提供一种能够区分血管微循环状态的患者监测器和/或生理监测传感器。在一些实施例中，患者监测器和/或传感器基于微循环状态提供警告和/或补偿测量。在一些实施例中，可由患者监测器和/或传感器实现的微循环确定过程用于确定患者的微循环状态。

