

US009055876B2

(12) **United States Patent**  
**Narayan et al.**

(10) **Patent No.:** **US 9,055,876 B2**  
(45) **Date of Patent:** **\*Jun. 16, 2015**

(54) **SYSTEM AND METHOD FOR RECONSTRUCTING CARDIAC ACTIVATION INFORMATION**

USPC ..... 600/301, 481, 483, 485-519; 607/4-5, 607/9, 25, 26  
See application file for complete search history.

(71) Applicants: **The Regents of the University of California**, Oakland, CA (US); **Topera, Inc.**, Scottsdale, AZ (US)  
(72) Inventors: **Sanjiv Narayan**, La Jolla, CA (US); **Carey Robert Briggs**, La Jolla, CA (US)  
(73) Assignees: **The Regents of the University of California**, Oakland, CA (US); **Topera, Inc.**, Menlo Park, CA (US); **The United States of America as represented by the Department of Veterans Affairs**, Washington, DC (US)

(56) **References Cited**

**U.S. PATENT DOCUMENTS**

5,121,750 A 6/1992 Katims  
5,172,699 A 12/1992 Svenson et al.

(Continued)

**FOREIGN PATENT DOCUMENTS**

WO 2008035070 A3 3/2008

**OTHER PUBLICATIONS**

PCT/US2012/036157 International Preliminary Report on Patentability and Written Opinion, Aug. 14, 2012, 8 pages.

(Continued)

(\* ) Notice: Subject to any disclaimer, the term of this patent is extended or adjusted under 35 U.S.C. 154(b) by 0 days.

This patent is subject to a terminal disclaimer.

(21) Appl. No.: **14/074,619**

(22) Filed: **Nov. 7, 2013**

(65) **Prior Publication Data**

US 2014/0066787 A1 Mar. 6, 2014  
**Related U.S. Application Data**

(63) Continuation of application No. 13/438,534, filed on Apr. 3, 2012, now Pat. No. 8,594,777, which is a continuation of application No. 13/217,123, filed on Aug. 24, 2011, now Pat. No. 8,165,666.

(60) Provisional application No. 61/481,607, filed on May 2, 2011.

(51) **Int. Cl.**  
**A61B 3/12** (2006.01)  
**A61B 5/04** (2006.01)  
(Continued)

(52) **U.S. Cl.**  
CPC ..... **A61B 5/04011** (2013.01); **A61B 5/0422** (2013.01); **A61B 5/0452** (2013.01);  
(Continued)

(58) **Field of Classification Search**  
CPC ..... A61B 5/0464; A61B 5/7203

*Primary Examiner* — Catherine Voorhees  
*Assistant Examiner* — Roland Dinga  
(74) *Attorney, Agent, or Firm* — Eleanor Musick; Greer Burns & Crain, Ltd.

(57) **ABSTRACT**

An example system and method of processing cardiac activation information are disclosed. The method includes accessing a first cardiac signal and a second cardiac signal obtained from a patient. The first cardiac signal and the second cardiac signal are processed to determine whether there is a point of change in the first cardiac signal at which a derivative of the first cardiac signal diverges with respect to a derivative of the second cardiac signal above a threshold. An activation onset time is assigned in the first cardiac signal at the point of change to define a cardiac activation if the point of change is in the first cardiac signal.

**33 Claims, 8 Drawing Sheets**

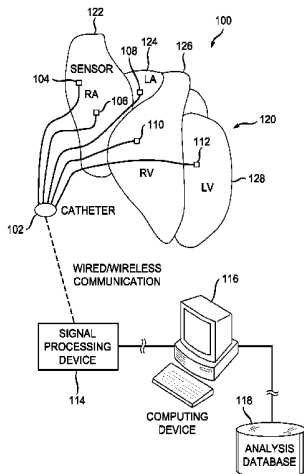

- (51) **Int. Cl.**  
*A61B 5/042* (2006.01)  
*A61B 5/0452* (2006.01)  
*A61B 5/00* (2006.01)  
*A61B 5/0205* (2006.01)  
*A61B 5/046* (2006.01)  
*A61B 5/0464* (2006.01)
- (52) **U.S. Cl.**  
 CPC ..... *A61B5/7239* (2013.01); *A61B 2562/046*  
 (2013.01); *A61B 5/0205* (2013.01); *A61B*  
*5/04012* (2013.01); *A61B 5/046* (2013.01);  
*A61B 5/0464* (2013.01); *A61B 5/7203*  
 (2013.01)

(56) **References Cited**

## U.S. PATENT DOCUMENTS

5,427,112 A	6/1995	Noren et al.
5,433,198 A	7/1995	Desai
5,450,846 A	9/1995	Goldreyer
5,480,422 A	1/1996	Ben-Haim
5,487,391 A	1/1996	Panescu
5,582,173 A	12/1996	Li
5,657,755 A	8/1997	Desai
5,662,108 A	9/1997	Budd et al.
5,687,737 A	11/1997	Branham et al.
5,718,241 A	2/1998	Ben-Haim et al.
5,795,303 A	8/1998	Swanson et al.
5,817,134 A	10/1998	Greenhut et al.
5,840,025 A	11/1998	Ben-Haim
5,848,972 A	12/1998	Triedman et al.
5,868,680 A	2/1999	Steiner et al.
5,954,665 A	9/1999	Ben-Haim
6,052,618 A	4/2000	Dahlke et al.
6,066,094 A	5/2000	Ben-Haim
6,115,628 A	9/2000	Stadler et al.
6,188,924 B1	2/2001	Swanson et al.
6,236,883 B1	5/2001	Ciaccio et al.
6,256,540 B1	7/2001	Panescu et al.
6,301,496 B1	10/2001	Reisfeld
6,360,121 B1	3/2002	Shoda
6,522,905 B2	2/2003	Desai
6,584,345 B2	6/2003	Govari
6,847,839 B2	1/2005	Ciaccio et al.
6,856,830 B2	2/2005	He
6,892,091 B1	5/2005	Ben-Haim et al.
6,920,350 B2	7/2005	Xue et al.
6,941,166 B2	9/2005	MacAdam et al.
6,959,212 B2	10/2005	Hsu et al.
6,975,900 B2	12/2005	Rudy et al.
6,978,168 B2	12/2005	Beatty et al.
7,016,719 B2	3/2006	Rudy et al.
7,043,292 B2	5/2006	Tarjan et al.
7,117,030 B2	10/2006	Berenfeld et al.
7,123,954 B2	10/2006	Narayan et al.
7,206,630 B1	4/2007	Tarler
7,245,962 B2	7/2007	Ciaccio et al.
7,263,397 B2	8/2007	Hauck et al.
7,283,865 B2	10/2007	Noren
7,289,843 B2	10/2007	Beatty et al.
7,328,063 B2	2/2008	Zhang et al.
7,505,810 B2	3/2009	Harlev et al.
7,515,954 B2	4/2009	Harlev et al.
7,751,882 B1	7/2010	Helland
7,761,142 B2	7/2010	Ghanem et al.
7,761,150 B2	7/2010	Ghanem et al.
7,907,994 B2	3/2011	Stolarski et al.
7,930,018 B2	4/2011	Harlev et al.
7,930,020 B2	4/2011	Zhang et al.
8,165,666 B1*	4/2012	Briggs et al. .... 600/515
8,165,671 B2	4/2012	Freeman et al.
8,175,702 B2	5/2012	Efimov et al.
8,521,266 B2	8/2013	Narayan et al.
8,594,777 B2*	11/2013	Briggs et al. .... 600/515
8,639,325 B2	1/2014	Efimov et al.

8,676,303 B2	3/2014	Narayan
8,700,140 B2	4/2014	Narayan et al.
2002/0010392 A1	1/2002	Desai
2003/0236466 A1	12/2003	Tarjan
2004/0073262 A1	4/2004	Lovett
2005/0148892 A1	7/2005	Desai
2005/0203502 A1	9/2005	Boveja et al.
2006/0084970 A1	4/2006	Beatty et al.
2006/0161206 A1	7/2006	Efimov et al.
2007/0055167 A1	3/2007	Bullinga
2007/0208260 A1	9/2007	Afonso
2007/0299351 A1	12/2007	Harlev et al.
2008/0097539 A1	4/2008	Belalcazar
2008/0109041 A1	5/2008	De Voir
2008/0114258 A1	5/2008	Zhang et al.
2009/0069704 A1	3/2009	MacAdam et al.
2009/0099468 A1	4/2009	Thiagalasingam et al.
2009/0112106 A1	4/2009	Zhang
2009/0112110 A1	4/2009	Zhang
2009/0112199 A1	4/2009	Zhang et al.
2009/0177071 A1	7/2009	Harlev et al.
2009/0177072 A1	7/2009	Harlev et al.
2009/0299424 A1	12/2009	Narayan
2010/0094274 A1	4/2010	Narayan
2010/0204592 A1	8/2010	Hatib et al.
2010/0217143 A1	8/2010	Whittington et al.
2010/0239627 A1	9/2010	Whitekettle et al.
2010/0298729 A1	11/2010	Zhang et al.
2010/0305456 A1	12/2010	Brauinard, II
2011/0087121 A1	4/2011	Zhang et al.
2011/0112425 A1	5/2011	Muhlsteff et al.
2011/0130801 A1	6/2011	Maskara et al.
2011/0196249 A1	8/2011	Staeuber et al.
2011/0251505 A1	10/2011	Narayan
2011/0282227 A1	11/2011	Zhang
2012/0232417 A1	9/2012	Zhang et al.
2013/0331718 A1	12/2012	Narayan et al.
2013/0006131 A1	1/2013	Narayan et al.
2013/0150740 A1	6/2013	Narayan et al.
2013/0150742 A1	6/2013	Briggs et al.
2013/0226016 A1	8/2013	Narayan et al.
2014/0066787 A1	3/2014	Narayan et al.
2014/0073981 A1	3/2014	Narayan et al.
2014/0114204 A1	4/2014	Narayan et al.
2014/0276152 A1	9/2014	Narayan et al.

## OTHER PUBLICATIONS

PCT/US2012/068639 International Preliminary Report on Patentability and Written Opinion, Jun. 10, 2013; 6 pages.

PCT/US/2014/029645 International Search Report and Written Opinion, Aug. 18, 2014, 17 pages.

PCT/US2012/068640 International Preliminary Report on Patentability and Written Opinion, Jun. 10, 2013; 5 pages.

PCT/US2014/029616 International Search Report and Written Opinion, Sep. 18, 2014; 9 pages.

Houben, R.P.M., et al., "Automatic mapping of human atrial fibrillation by template matching", *Heart Rhythm*, vol. 3, No. 10, Oct. 1, 2006, pp. 1221-1228.

Nademanee, Koonlawee, et al., "A new approach for catheter ablation of atrial fibrillation: mapping of the electrophysiologic substrate", *J. Amer.Coll.Cardiol.*, vol. 43, No. 11, Jun. 2, 2004, pp. 2044-2053.

Narayan, S.M., et al., "Dynamics factors preceding the initiation of atrial fibrillation in humans", *Heart Rhythm*, vol. 5, No. 6, Jun. 1, 2008, pp. S22-S25.

Ciaccio, Edward J. et al., "Development of Gradient Descent Adaptive Algorithms to Remove Common Mode Artifact for Improvement of Cardiovascular Signal Quality", *Annals of Biomedical Engineering*, vol. 35, No. 7, Jul. 2007, pp. 1146-1155.

Sornborger, Andrew, et al., "Extraction of Periodic Multivariate Signals: Mapping of Voltage-Dependent Dye Fluorescence in the Mouse Heart", *IEEE Transactions on Medical Imaging*, vol. 22, No. 12, Dec. 2003, pp. 1537-1549.

Sun, Yan, et al., "Characteristic wave detection in ECG signal using morphological transform", *BMC Cardiovascular Disorders*, vol. 5, No. 28, 2005.

(56)

**References Cited**

## OTHER PUBLICATIONS

Tai, Dean C.S., et al., "Correction of motion artifact in transmembrane voltage-sensitive fluorescent dye emission in hearts", *Am. J. Physiol. Heart Circ. Physiol.*, vol. 287, 2004, pp. H985-H993.

Lin, Y-J, et al., "Electrophysiological Characteristics and Catheter Ablation in Patients With Paroxysmal Right Atrial Fibrillation", *Circulation*, Sep. 20, 2005; 112(12): 1692-1700, EPub Sep. 12, 2005.

Houben, R.P.M., et al., "Processing of Intracardiac Electrograms in Atrial Fibrillation", *IEEE Engineering in Medicine and Biology Magazine*, 2006, Nov./Dec., pp. 40-51.

Saksena, S., et al., "Regional Endocardial Mapping of Spontaneous and Induced Atrial Fibrillation in Patients With Heart Disease and Refractory Atrial Fibrillation", *Am J Cardiol*, 1999; 84:880-889.

EP 12711553 Supplementary European Search Report, Sep. 4, 2013, 7 pages.

PCT/US2012/029935 International Search Report and Written Opinion, Nov. 8, 2012, 9 pages.

EP 09819953 Supplementary European Search Report, Feb. 7, 2012, 5 pages.

PCT/US2011/031468 International Preliminary Report on Patentability, Oct. 9, 2012, 8 pages.

PCT/US2011/031470 International Preliminary Report on Patentability, Oct. 9, 2012, 7 pages.

PCT/US2009/060178 International Preliminary Report on Patentability, Apr. 12, 2011, 10 pages.

Umapathy, K., et al. "Spatiotemporal Frequency Analysis of Ventricular Fibrillation in Explanted Human Hearts," *IEEE Transactions in Biomedical Engineering*, IEEE Service Center, Piscataway, NJ USA, vol. 56, No. 2, Feb. 1, 2009, pp. 328-335.

Kalifa, J, et al. "Mechanisms of wave fractionation at boundaries of high-frequency excitation in the posterior left atrium of the isolated sheep heart during atrial fibrillation," *Circulation*, vol. 113, No. 5, Feb. 7, 2006, pp. 626-633.

Yenn-Jiang L, et al. "Electrophysiological Mechanisms and Catheter Ablation of Complex Atrial Arrhythmias from Crista Terminalis: Insight from Three-Dimensional Noncontact Mapping," *Pacing and Clinical Electrophysiology*, vol. 27, No. 9, Sep. 1, 2004, pp. 1231-1239.

Supplementary European Search Report & European Search Opinion issued in EP 12779506.0, mailed Nov. 18, 2014, 8 pages.

\* cited by examiner

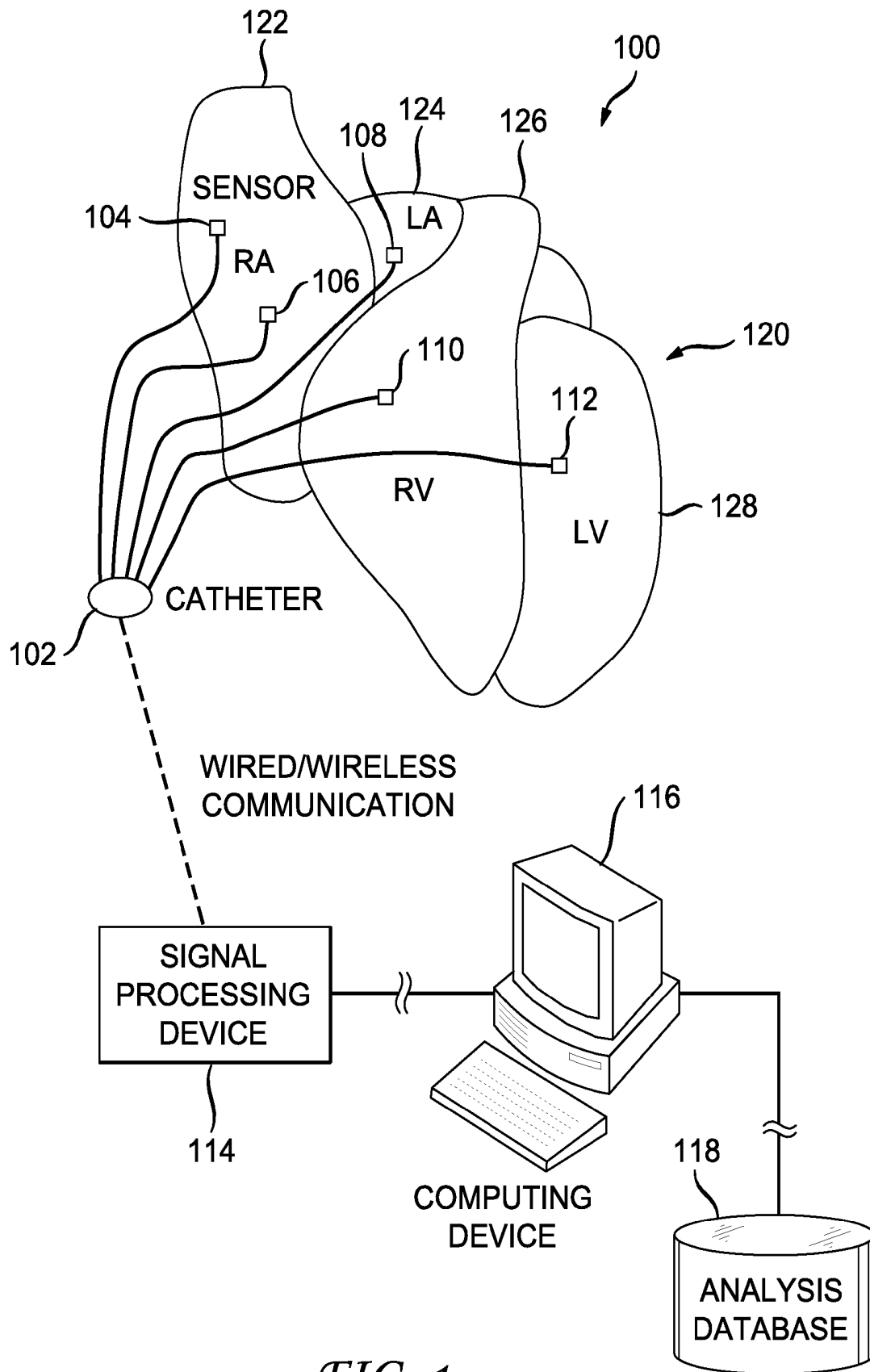

FIG. 1

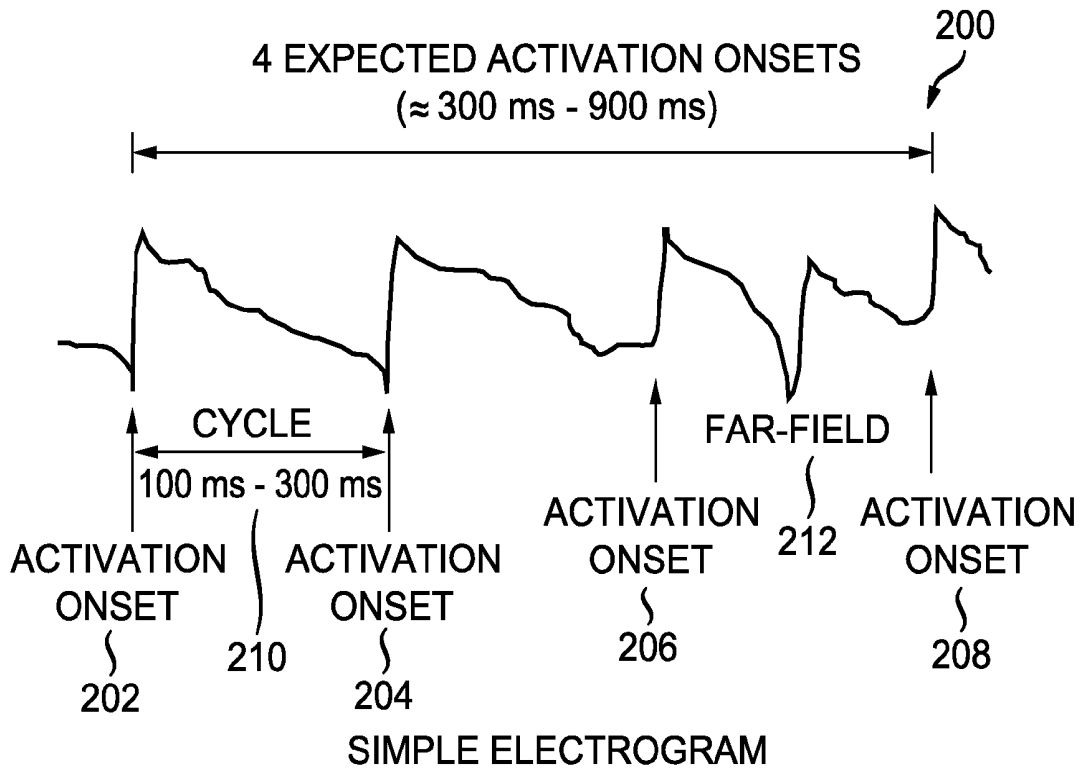

FIG. 2

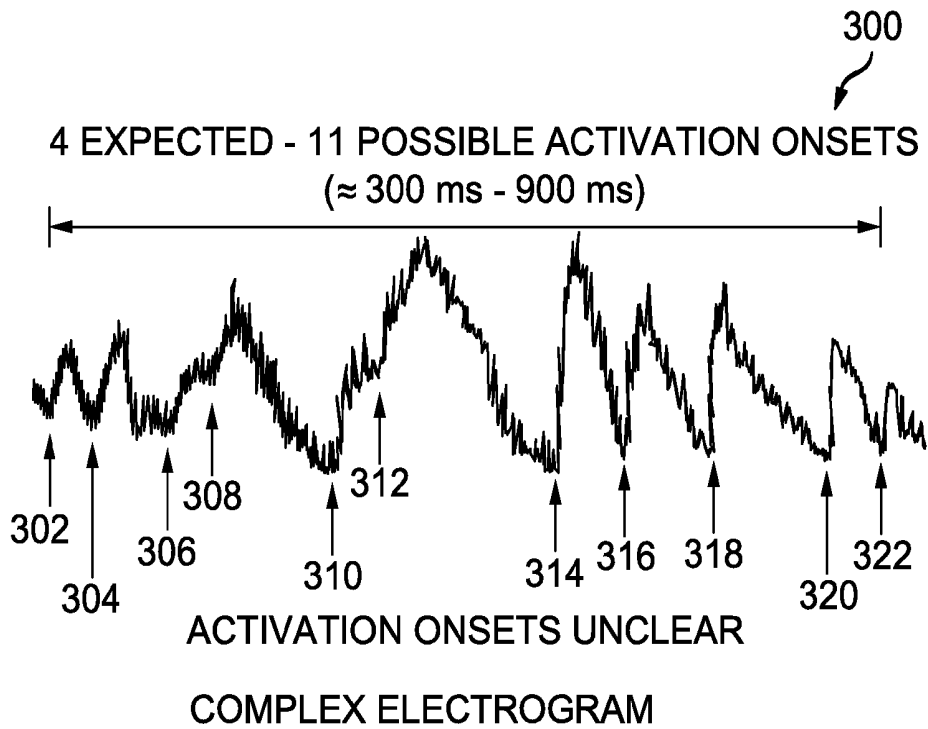
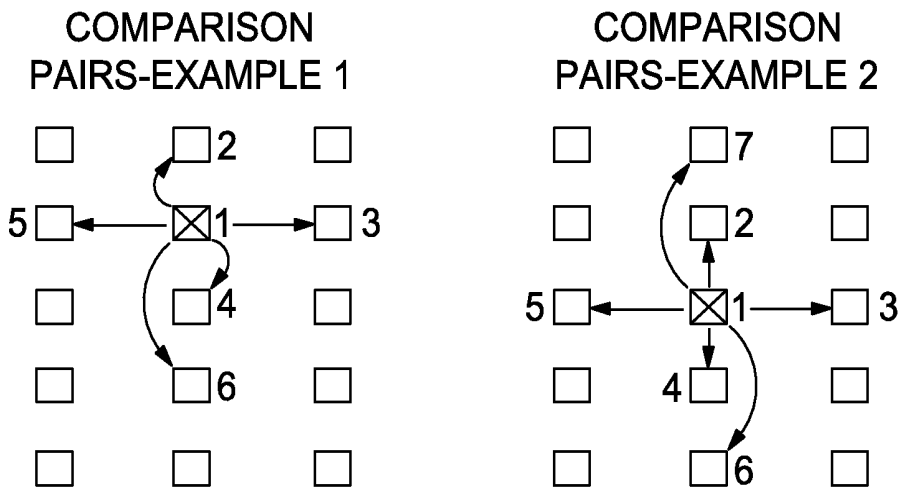
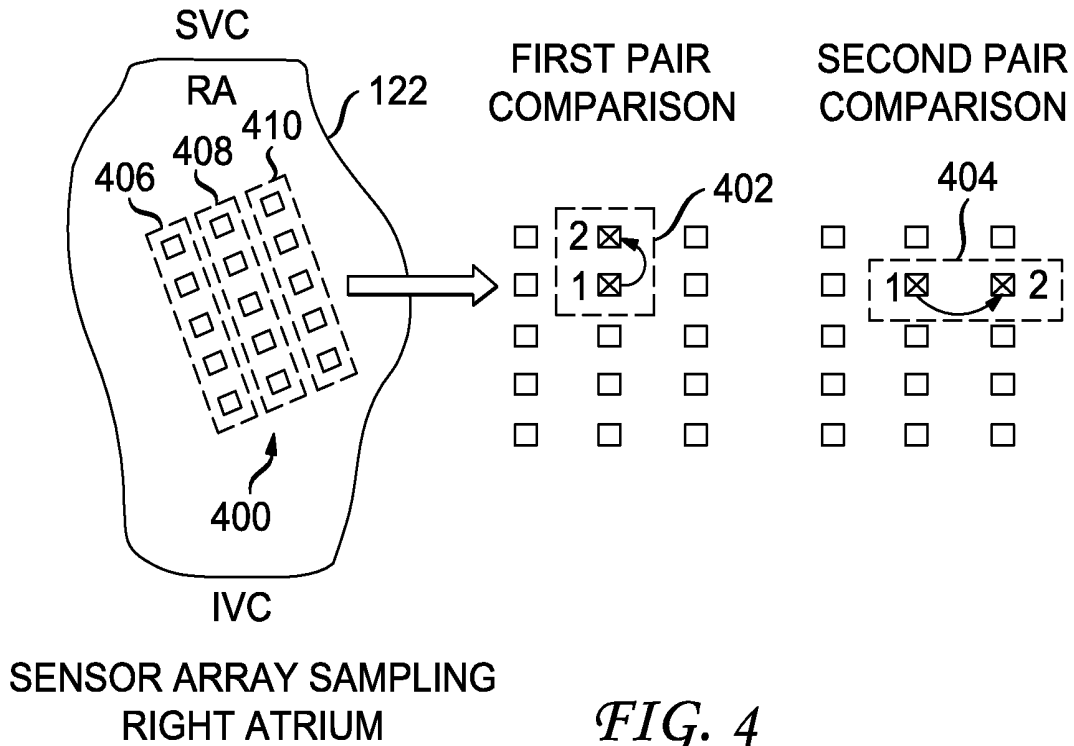
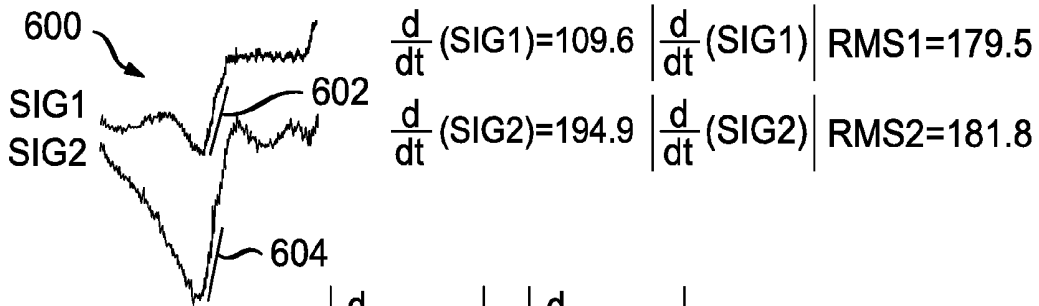

FIG. 3



*FIG. 5*

FAR-FIELD ACTIVATION  
(NOT SIGNIFICANTLY LOCAL)



$$\frac{d}{dt}(\text{SIG1}) = 109.6 \quad \left| \frac{d}{dt}(\text{SIG1}) \right| \text{RMS1} = 179.5$$

$$\frac{d}{dt}(\text{SIG2}) = 194.9 \quad \left| \frac{d}{dt}(\text{SIG2}) \right| \text{RMS2} = 181.8$$

$$\text{SIGNIFICANCE } (\delta) = \frac{\left| \frac{d}{dt}(\text{SIG1}) \right|}{\text{RMS1}} - \frac{\left| \frac{d}{dt}(\text{SIG2}) \right|}{\text{RMS2}} = \frac{109.6}{179.5} - \frac{194.9}{181.8} = -0.461$$

FIG. 6

BACKGROUND NOISE

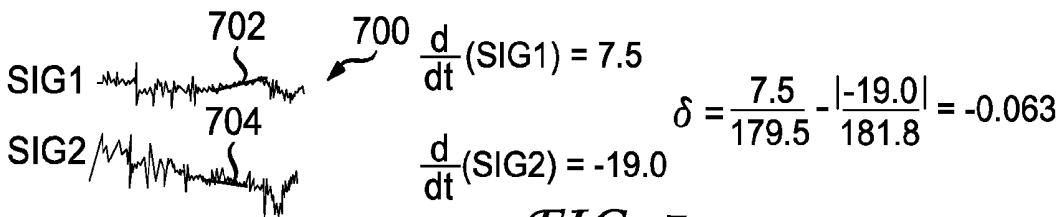

$$\frac{d}{dt}(\text{SIG1}) = 7.5$$

$$\frac{d}{dt}(\text{SIG2}) = -19.0$$

$$\delta = \frac{7.5}{179.5} - \frac{|-19.0|}{181.8} = -0.063$$

FIG. 7

LOCAL ACTIVATION ONSET

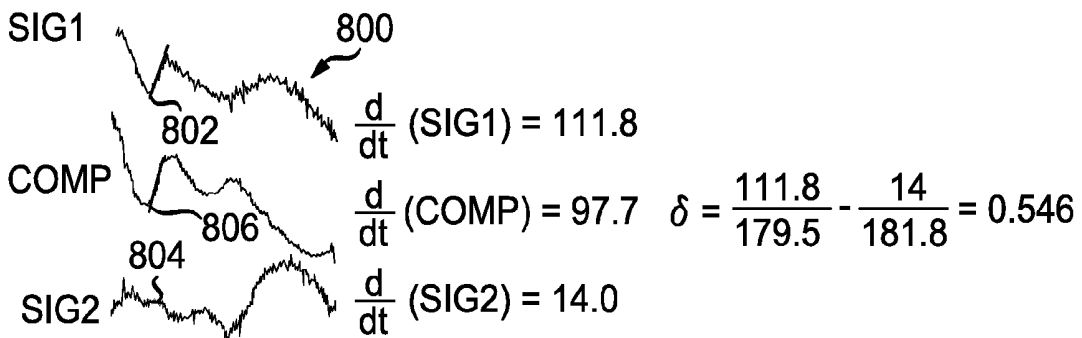

$$\frac{d}{dt}(\text{SIG1}) = 111.8$$

$$\frac{d}{dt}(\text{COMP}) = 97.7$$

$$\frac{d}{dt}(\text{SIG2}) = 14.0$$

$$\delta = \frac{111.8}{179.5} - \frac{14}{181.8} = 0.546$$

USING THE COMPOSITE:

$$\delta = \frac{\left| \frac{d}{dt}(\text{SIG2}) \right| - \left| \frac{d}{dt}(\text{COMP}) \right|}{\ln \left[ \left| \frac{d}{dt}(\text{SIG1}) - \frac{d}{dt}(\text{COMP}) \right| \right]} = \frac{|14 - 97.7|}{\ln [|111.8 - 97.7|]} = 31.63$$

FIG. 8

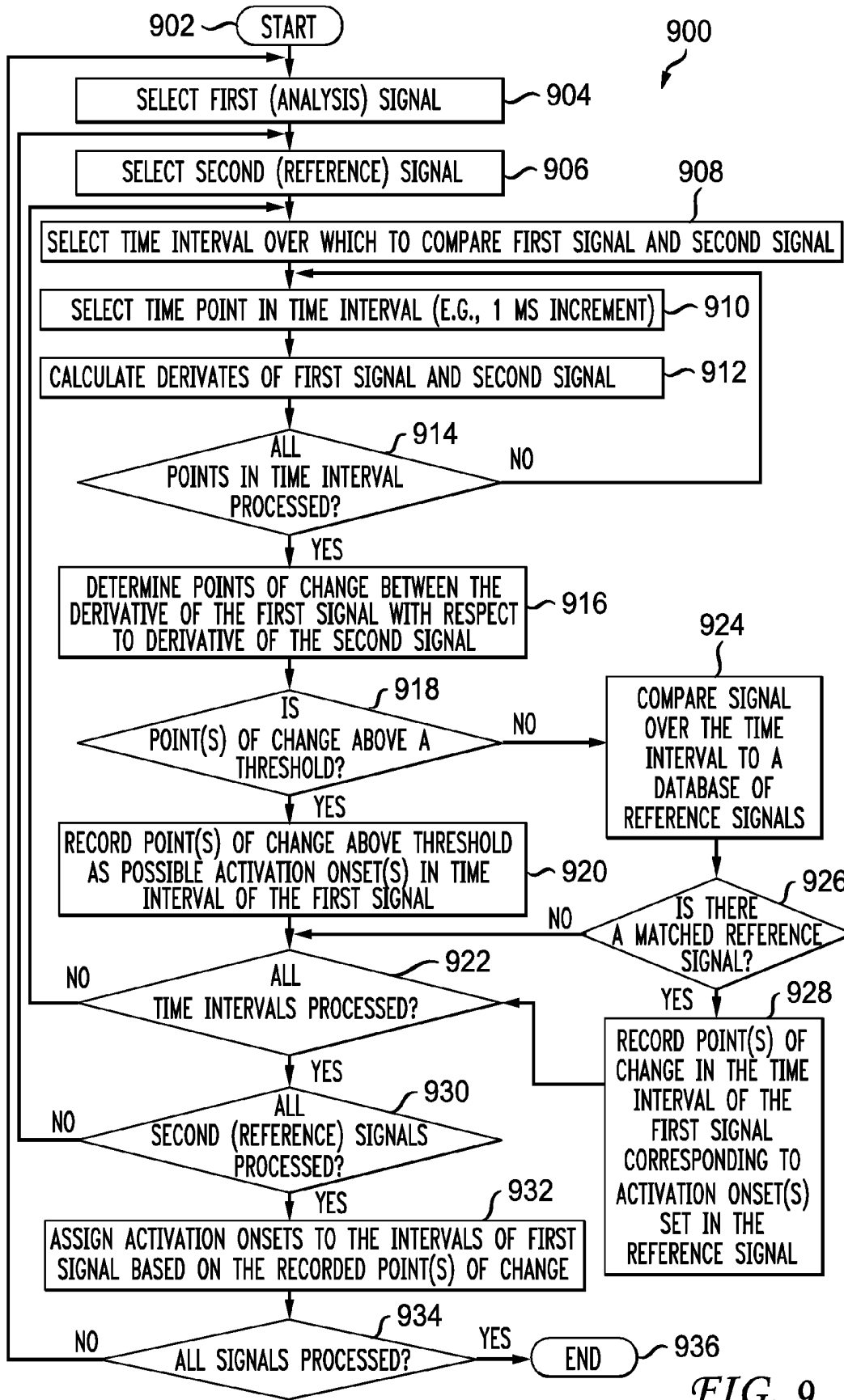

FIG. 9

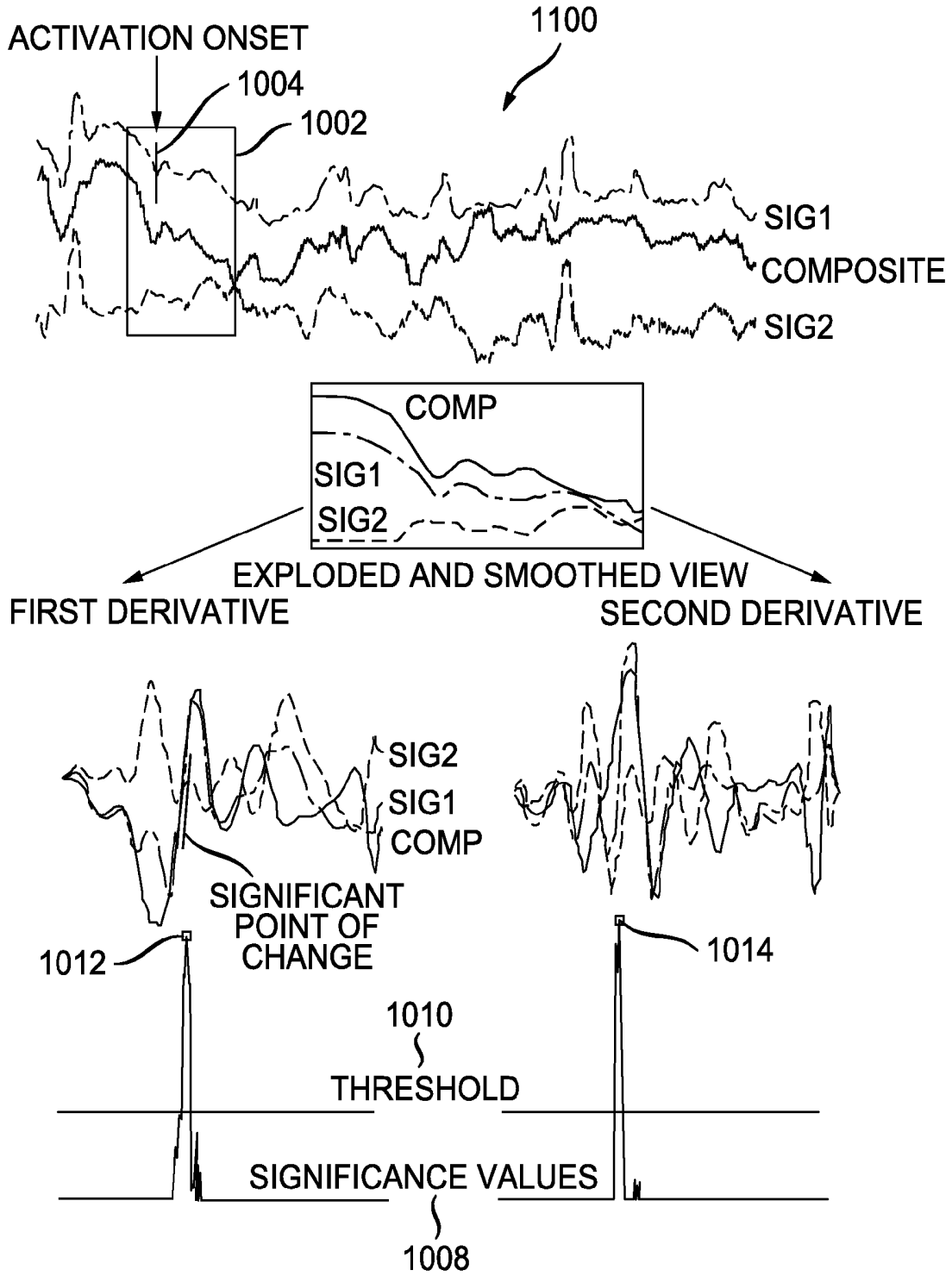

FIG. 10

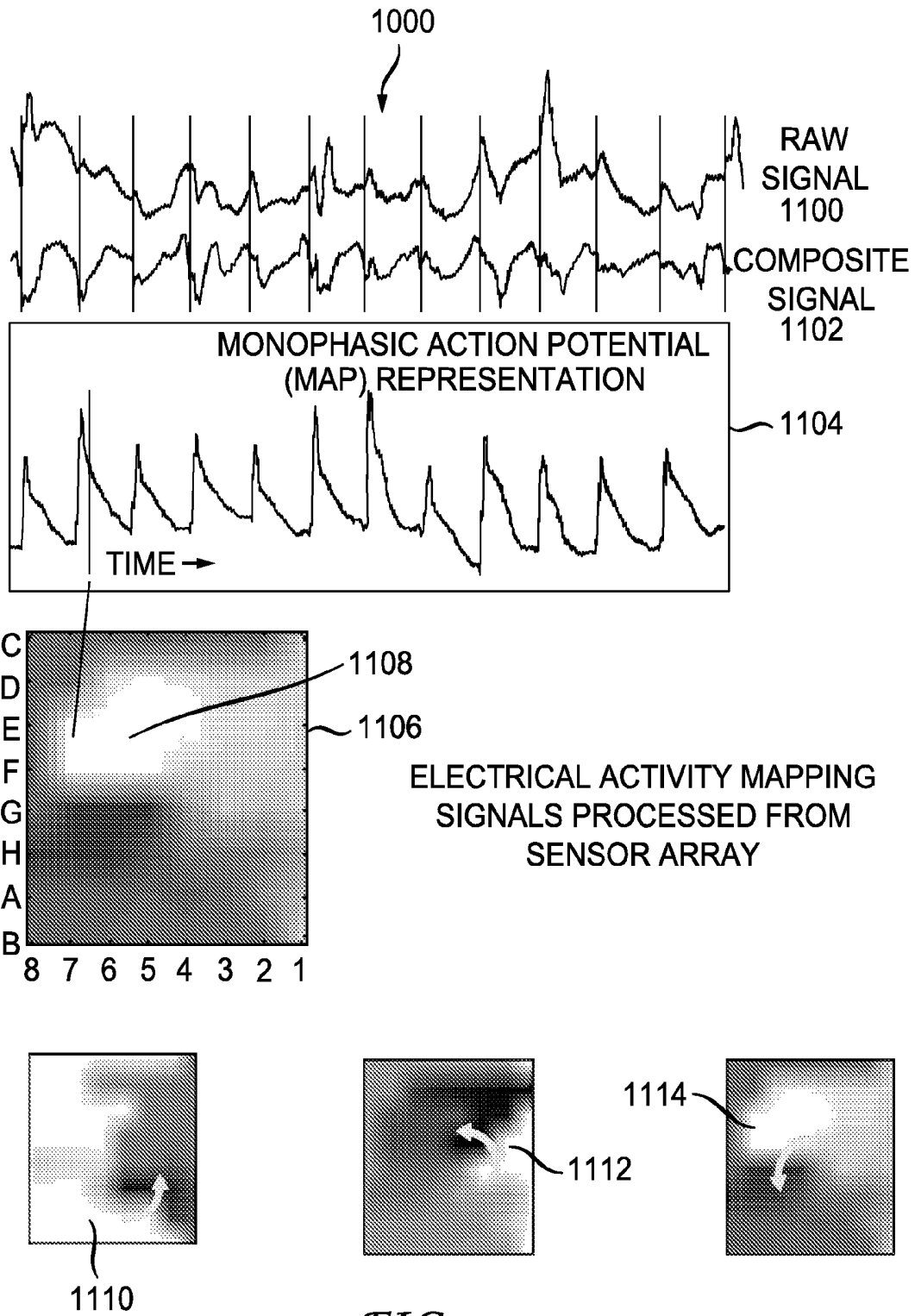
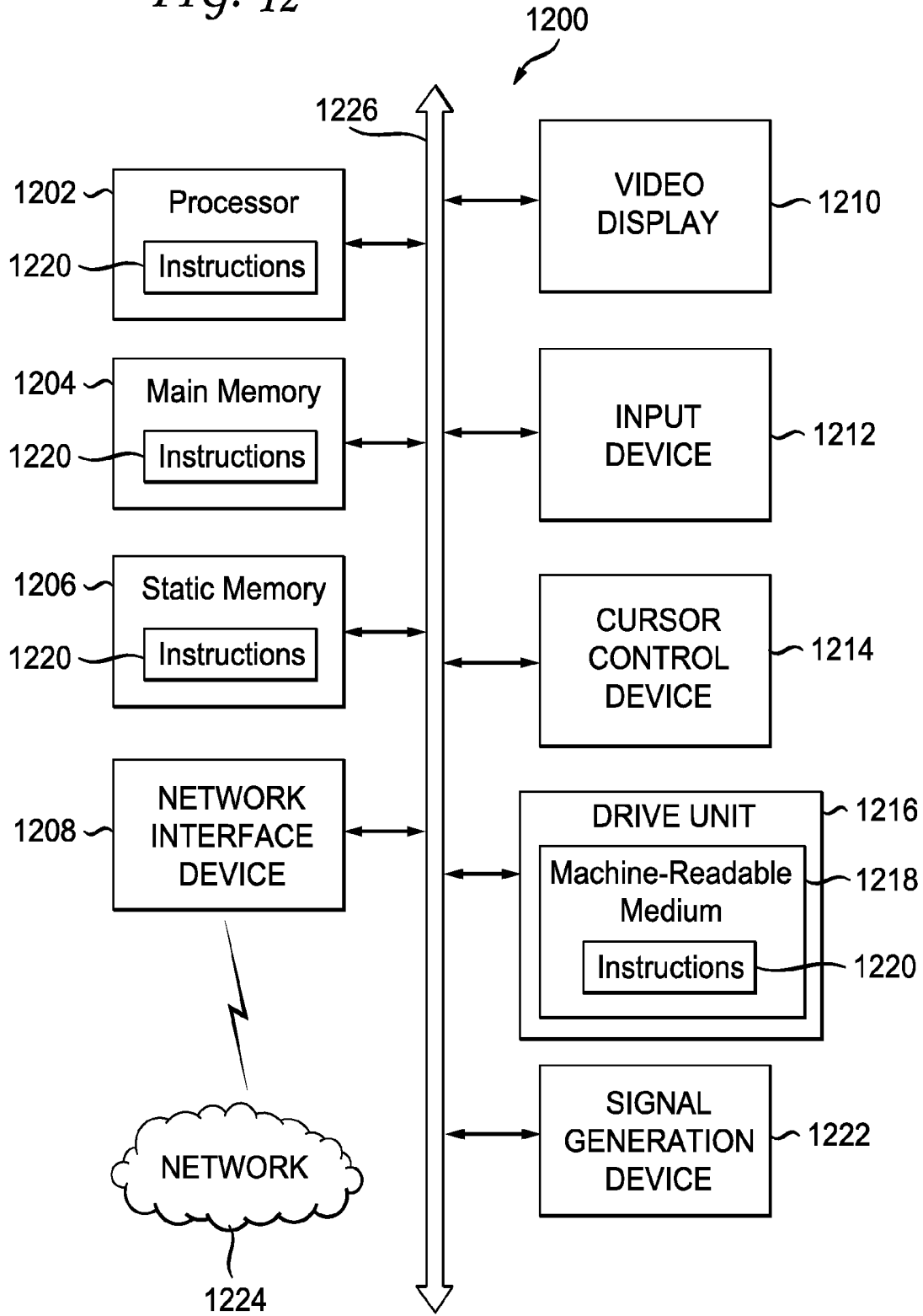

FIG. 11

FIG. 12



## SYSTEM AND METHOD FOR RECONSTRUCTING CARDIAC ACTIVATION INFORMATION

### RELATED APPLICATIONS

This application is a continuation of U.S. application Ser. No. 13/438,534 filed on Apr. 3, 2012, issued Nov. 26, 2013 as U.S. Pat. No. 8,594,777, which is a continuation of U.S. application Ser. No. 13/217,123 filed on Aug. 24, 2011, now U.S. Pat. No. 8,165,666, which claims priority to and benefit of U.S. Provisional Application No. 61/481,607 filed on May 2, 2011, all of which are incorporated herein by reference in their entireties.

### GOVERNMENT RIGHTS

This invention was made with government support under Grants R01 HL83359, HL83359-S1 and HL103800 awarded by the National Institutes of Health. The government has certain rights in the invention.

### BACKGROUND

#### (1) Field

The present application relates generally to heart rhythm disorders. More specifically, the present application is directed to a system and method for reconstructing cardiac activation information (activation onset) associated with heart rhythm disorders.

#### (2) Brief Discussion of Related Art

Heart (cardiac) rhythm disorders are common and represent significant causes of morbidity and death throughout the world. Malfunction of the electrical system in the heart represents a proximate cause of heart rhythm disorders. Heart rhythm disorders exist in many forms, of which the most complex and difficult to treat are atrial fibrillation (AF), ventricular tachycardia (VT) and ventricular fibrillation (VF). Other rhythm disorders are more simple to treat, but may also be clinically significant including atrial tachycardia (AT), supraventricular tachycardia (SVT), atrial flutter (AFL), supraventricular ectopic complexes/beats (SVE) and premature ventricular complexes/beats (PVC). While under normal conditions the sinus node keeps the heart in sinus rhythm, under certain conditions rapid activation of the normal sinus node can cause inappropriate sinus tachycardia or sinus node reentry, both of which also represent heart rhythm disorders.

Treatment of heart rhythm disorders—particularly complex rhythm disorders of AF, VF and polymorphic VT—can be very difficult. Pharmacologic therapy for complex rhythm disorder is not optimal, with poor efficacy and significant side effects. Ablation has been used increasingly in connection with heart rhythm disorders by maneuvering a sensor/probe to the heart through the blood vessels, or directly at surgery, and delivering energy to a location of the heart that harbors a cause of the heart rhythm disorder to mitigate and in some cases to eliminate the heart rhythm disorder. However, in complex rhythm disorders ablation is often difficult and ineffectual because tools that identify and locate a cause of the heart rhythm disorder are poor and hinder attempts to deliver energy to the correct region of the heart to eliminate the disorder.

Certain systems and methods are known for treating simple heart rhythm disorders. In a simple heart rhythm disorder (e.g., atrial tachycardia), consistent activation onset patterns from beat to beat can generally be traced back to an earliest location, which can be ablated to mitigate and in some cases

to eliminate the disorder. Even in simple heart rhythm disorders, such ablation of the cause of a heart rhythm disorder is challenging and experienced practitioners often require hours to ablate simple rhythm disorders with consistent beat-to-beat activation patterns, such as atrial tachycardia.

There are no known systems and methods that have been successful with respect to identifying causes for the complex rhythm disorders such as AF, VF or polymorphic VT. In a complex rhythm disorder, an earliest location of activation onsets cannot be identified because activation onset patterns change from beat to beat, and are “continuous” such that there is no identifiable earliest point (or start) or latest point (or end).

Diagnosing and treating heart rhythm disorders often involves the introduction of a catheter having a plurality of sensors/probes into the heart through the blood vessels of a patient. The sensors detect electric activity of the heart at sensor locations in the heart. The electric activity is generally processed into electrogram signals that represent the activation of the heart at the sensor locations.

In a simple heart rhythm disorder, the signal at each sensor location is generally consistent from beat to beat in timing and often in shape and number of its deflections, enabling identification of activation onsets at each sensor location. However, in a complex rhythm disorder, the signal at each sensor location from beat to beat may transition between one, several, and multiple deflections of various shapes. For instance, when a signal for a sensor location in AF includes 5, 7, 11 or more deflections, it is difficult if not impossible to identify which deflections in the signal are at or near the sensor location in the heart (i.e., local activation) versus a further removed location still sensed by the sensor in the heart (i.e., far-field activation) or simply noise from another part of the patient’s heart, other anatomic structures, movement or motion of the sensor relative to the heart or external electronic systems.

There are no known systems and methods that have been able to reconstruct cardiac activation information (onsets) in variously shaped signals associated with heart rhythm disorders, especially in complex rhythm disorders, to facilitate identification of a cause of the heart rhythm disorders and their elimination.

### SUMMARY

The present invention is applicable to reconstructing activation information of various rhythm disorders, including heart rhythm disorders, as well as other biological rhythm disorders, such as neurological seizures, esophageal spasms, bladder instability, irritable bowel syndrome, and other biological disorders for which biological activation information can be reconstructed to permit determination, diagnosis, and/or treatment of the cause or source of the disorders. It is particularly useful, however, in complex rhythm disorders which result in complex activation patterns, and especially useful in complex rhythm disorders of the heart, in order to find the cause(s) or source(s) of the disorders such that they can be treated with expediency.

Complex heart rhythm disorders typically result in activation patterns that are extremely difficult to decipher and the ability to determine accurate activation information of heartbeats in complex disorders has previously not been possible. Among the advantages of the present invention is the ability to reconstruct cardiac activation information such that a determination of the cause and/or source of the disorder can be determined and treated. Another advantage is that the present invention provides a system and method which can be

carried out rapidly while a sensing device—such as a catheter having sensors thereon—is used in or near the patient and can be followed by treatment of cardiac tissue to ameliorate the disorder and in many cases cure the disorder. Treatment may thus occur immediately upon computing the reconstructed cardiac information, since it will provide the location(s) of the cause or source of the disorder.

Prior systems and methods suffered from the inability to determine the source of heart rhythm disorders and consequently provided no means of targeting the source for meaningful and curative treatment. Additionally, prior systems and methods required numerous and complex steps of treatment and yet still failed to provide a means of reconstructing cardiac activation information sufficient to identify the cause(s) or source(s) of the heart rhythm disorder.

In contrast to prior systems and methods, the present invention provides a relatively few number of steps to reconstruct the activation information in order to determine the activation onset times at various sensor locations for a heartbeat amidst the virtually indiscernible activation patterns.

As used herein, reconstruction is a process of identifying activation onset time in a cardiac or biological signal at a sensor location distinct from nearby or adjacent sensor locations for one or more beats of a biological or cardiac rhythm disorder.

As used herein, activation onset time is a time point at which activation commences in a cell or tissue, as opposed to other time points during activation.

As used herein, activation is a process whereby a cell commences its operation from a quiescent (diastolic) state to an active (electrical) state.

In accordance with an embodiment or aspect, a system to process cardiac activation information is disclosed. The system includes at least one computing device. The computing device is configured to access a first cardiac signal and a second cardiac signal obtained from a patient. The computing device is also configured to process the first cardiac signal and the second cardiac signal to determine whether there is a point of change in the first cardiac signal at which a derivative of the first cardiac signal diverges with respect to a derivative of the second cardiac signal above a threshold. The computing device is further configured to assign an activation onset time in the first cardiac signal at the point of change to define a cardiac activation if the point of change is in the first cardiac signal. The point of change can be determined at about the same time point for both the first cardiac signal and the second cardiac signal.

The computing device can form a composite cardiac signal from the first cardiac signal and the second cardiac signal, and can determine ratio values at a plurality of points in the first cardiac signal. Each ratio value can represent a difference between the derivative of the second cardiac signal and a derivative of the composite cardiac signal to a difference between the derivative of the first cardiac signal and the derivative of the composite cardiac signal. The computing device can also select as the point of change in the first cardiac signal a point having a largest ratio value from the determined ratio values.

The computing device can match at least one characteristic of the first cardiac signal to at least one characteristic of a reference cardiac signal in a catalog of cardiac signals if there is no point of change in the first cardiac signal. Thereafter, the computing device can assign an activation onset time in the first cardiac signal as an onset time of the reference cardiac signal to define a cardiac activation in the first cardiac signal.

The computing device can iteratively access pairs of cardiac signals from a plurality of cardiac signals. Each pair can

include a first cardiac signal and different second cardiac signal. The computing device can process and assign for each of the pairs to define multiple cardiac activations in the first cardiac signal in each of the pairs. The computing device can further reconstruct a cardiac activation pattern based on assigned activation onset times of cardiac activations from the plurality of cardiac signals to indicate a source of a cardiac rhythm disorder. The computing device can also display the reconstructed cardiac activation pattern to facilitate treatment of cardiac tissue at the source to suppress, lessen or eliminate the cardiac rhythm disorder.

In accordance with another embodiment or aspect, a method of processing cardiac activation information is disclosed. The method includes accessing a first cardiac signal and a second cardiac signal obtained from a patient. The method also includes processing the first cardiac signal and the second cardiac signal to determine whether there is a point of change in the first cardiac signal at which a derivative of the first cardiac signal diverges with respect to a derivative of the second cardiac signal above a threshold. The method further includes assigning an activation onset time in the first cardiac signal at the point of change to define a cardiac activation if the point of change is in the first cardiac signal. The point of change can be determined at about the same time point for the first cardiac signal and the second cardiac signal.

The determination of the point of change in the method can include the following operations. A composite cardiac signal can be formed from the first cardiac signal and the second cardiac signal. Ratio values at a plurality of points in the first cardiac signal can be determined. Each ratio value can represent a difference between the derivative of the second cardiac signal and a derivative of the composite cardiac signal to a difference between derivative of the first cardiac signal and the derivative of the composite cardiac signal. A point having a largest ratio value from the determined ratio values can be selected as the point of change in the first cardiac signal.

If there is no point of change in the first cardiac signal, the method can include matching at least one characteristic of the first cardiac signal to at least one characteristic of a reference cardiac signal in a catalog of cardiac signals. Thereafter, an activation onset time of the reference cardiac signal can then be assigned as an activation onset time in the first cardiac signal to define a cardiac activation in the first cardiac signal.

The method of processing cardiac activation information can further include iteratively accessing pairs of cardiac signals from a plurality of cardiac signals. Each pair includes a first cardiac signal and different second cardiac signal. The operations of processing and assigning for each of the pairs can be performed to define multiple cardiac activations in the first cardiac signal in each of the pairs. Thereafter, a cardiac activation pattern can be reconstructed based on assigned activation onset times of cardiac activations from the plurality of cardiac signals to indicate a source of a cardiac rhythm disorder.

These and other purposes, goals and advantages of the present application will become apparent from the following detailed description read in connection with the accompanying drawings.

#### BRIEF DESCRIPTION OF THE DRAWINGS

Some embodiments or aspects are illustrated by way of example and not limitation in the figures of the accompanying drawings in which like numbers refer to like parts, and in which:

FIG. 1 illustrates an example cardiac activation reconstruction system;

FIG. 2 illustrates an example simple electrogram signal of a heart rhythm disorder from a sensor positioned at a sensor location in a heart illustrated in FIG. 1;

FIG. 3 illustrates an example complex electrogram signal of a heart rhythm disorder from a sensor positioned at a sensor location in a heart illustrated in FIG. 1;

FIG. 4 illustrates an example array of sensors of a catheter illustrated in FIG. 1 and an example selection of signals from the sensors to reconstruct cardiac activation information;

FIG. 5 illustrates example comparison pairs of signals from the sensors of the array illustrated in FIG. 4;

FIG. 6 is an illustration of an example signal pair comparison of analysis signal (SIG1) and reference signal (SIG2);

FIG. 7 is an illustration of another example signal pair comparison of analysis signal (SIG1) and reference signal (SIG2);

FIG. 8 is an illustration of a further example signal pair comparison of analysis signal (SIG1) and reference signal (SIG2) utilizing a composite signal;

FIG. 9 is a flowchart that illustrates an example method of reconstructing cardiac activation information associated with heart rhythm disorders;

FIG. 10 is an illustration of an example signal pair comparison of analysis signal (SIG1) and reference signal (SIG2) that can be processed in accordance with the method of FIG. 9 to reconstruct cardiac activation information;

FIG. 11 is an illustration of an example mapping of processed signals in accordance with FIGS. 1-10; and

FIG. 12 is a block diagram of an illustrative embodiment of a general computer system.

## DETAILED DESCRIPTION

A system and method for reconstructing cardiac activation information associated with heart rhythm disorders are disclosed herein. In the following description, for the purposes of explanation, numerous specific details are set forth in order to provide a thorough understanding of example embodiments or aspects. It will be evident, however, to one skilled in the art, that an example embodiment may be practiced without all of the disclosed specific details.

FIG. 1 illustrates an example cardiac activation reconstruction system 100. The example system 100 is configured to detect and reconstruct cardiac activation information collected/detected from a patient's heart in connection with a heart rhythm disorder. The heart includes a right atrium 122, left atrium 124, right ventricle 126 and left ventricle 128.

The example system 100 includes a catheter 102, signal processing device 114, computing device 116 and analysis database 118.

The catheter 102 is configured to detect cardiac activation information in the heart and to transmit the detected cardiac activation information to the signal processing device 114, either via a wireless or wired connection. The catheter includes a plurality of probes/sensors 104-112, which can be inserted into the heart through the patient's blood vessels.

In some embodiments or aspects, one or more of the sensors 104-112 are not inserted into the patient's heart. For example, some sensors may detect cardiac activation via the patient's surface (e.g., electrocardiogram) or remotely without contact with the patient (e.g., magnetocardiogram). As another example, some sensors may also derive cardiac activation information from cardiac motion of a non-electrical sensing device (e.g., echocardiogram). In various embodiments or aspects, these sensors can be used separately or in different combinations, and further these separate or different

combinations can also be used in combination with sensors inserted into the patient's heart.

The sensors 104-112, which are positioned at sensor locations in the heart under consideration, can detect cardiac activation information at the sensor locations and can further deliver energy to ablate the heart at the sensor locations. It is noted that the sensors 104-112 can also detect cardiac activation information from overlapping regions of the heart (e.g., right atrium 122 and left atrium 124).

The signal processing device 114 is configured to process (e.g., clarify and amplify) the cardiac activation information detected by the sensors 104-112 at the sensor locations into electrogram signals and to provide the processed cardiac signals to the computing device 116 for analysis or processing in accordance with methods disclosed herein. In processing the cardiac activation information from the sensors 104-112, the signal processing device 114 can subtract cardiac activation information from overlapping regions of the heart 120 to provide processed cardiac signals to the computing device 116 for analysis. While in some embodiments or aspects, the signal processing device 114 is configured to provide unipolar signals, in other embodiments or aspects, the signal processing device 114 can provide bipolar signals.

The computing device 116 is configured to receive (or access) cardiac signals from the signal processing device 114 and further configured to analyze or process the cardiac signals in accordance with methods, functions or logic disclosed herein to reconstruct cardiac activation information in the cardiac signals such that it is possible to locate a cause of the heart rhythm disorder and to eliminate the cause.

For example, the computing device 116 can process a first cardiac signal and a second cardiac signal from the received cardiac signals to determine whether there is a point of change in a derivative of the first cardiac signal with respect to a derivative of the second cardiac signal above a threshold. The computing device 116 can then assign an activation onset time in the first signal at the point of change to define cardiac activation indicating a beat in the first signal if it is determined that the point of change is above the threshold.

As another example, the computing device 116 can iteratively select pairs of cardiac signals from the received cardiac signals, each pair having a first cardiac signal and second cardiac signal. The computing device 116 can process and assign for each of the pairs in order to define multiple cardiac activations indicating beats for the first cardiac signal in each of the pairs. For example, the computing device 116 is configured to perform processing and assigning to define multiple cardiac activations indicating beats in the first cardiac signal. The computing device 116 can then reconstruct a cardiac activation pattern based on assigned activation onset times of cardiac activations from the received cardiac signals to indicate a source of a rhythm disorder. In some embodiments or aspects, the computing device 116 can also display the reconstructed cardiac activation pattern to facilitate treatment of cardiac tissue at the source to suppress, lessen or eliminate the cardiac rhythm disorder.

The analysis database 118 is configured to support or aid in the analysis of the signals by the computing device 116. In some embodiments or aspects, the analysis database 118 can store a catalog of reference signals and associated activations to enable the computing device 116 to determine an activation onset associated with a signal being considered (e.g., when point of change is below threshold during a time window), as will be described in greater detail herein.

FIG. 2 illustrates an example simple electrogram signal 200 of a heart rhythm disorder from a sensor positioned at a sensor location in the heart 120. For example, sensor 104 of

catheter **102** can be positioned at a sensor location in the right atrium **122**, as shown in FIG. **1**. As an example, the heart rhythm disorder can be a complex rhythm disorder AF, VF and polymorphic VT, or another heart rhythm disorder.

The example signal **200** is for a time period between about 300 ms and about 900 ms. During this time period, the signal **200** is expected to have four (4) local activation onsets **204-208**, e.g., those activation onsets that originate at or near (locally to) the sensor location in the heart **120** of sensor **104**. Specifically, based on established observations in heart rhythm disorders, cycle length between activation onsets of about 100 ms to about 300 ms can be expected for AF, and cycle length between activation onsets of about 180 ms to about 240 ms can be expected for complex ventricular arrhythmias. As an example, cycle length **210** of about 100 ms to about 300 is expected between activation onset **202** and activation onset **204**. In the example signal **200**, the activation onsets **204-208** are generally identifiable as having a small degree of baseline wander superposed in the local signal with few far-field artifacts that could be mistaken as local activity. Local activity in this example can be characterized by an activation onset with a sharp inflection point and high slope, followed by a period of gentle, low-deviation slope representing repolarization, typically lasting between about 100 ms and 250 ms.

In the example signal **200**, an example far-field deflection **212** is illustrated between location activation onset **206** and local activation onset **208**, e.g., an activation onset that originates at a location in the heart **120** that is different than the sensor location associated with the sensor **104**. Specifically, the heart **120** at the sensor location associated with sensor **104** cannot physiologically activate again after activation onset **206** in a shorter cycle than about 100 ms to about 300 ms because local tissue must undergo repolarization. Moreover, the deflection **212** cannot be local to the sensor location associated with the sensor **104** when the deflection **212** is also significantly present in signals collected by neighbor sensors in multiple directions to sensor **104**. For example, the far-field deflection **212** detected by sensor **104** can be associated with activation onset at a sensor location associated with sensor **106**.

FIG. **3** illustrates an example complex electrogram signal **300** of a heart rhythm disorder from a sensor positioned at a sensor location in the heart **120**. For example, sensor **106** of catheter **102** can be positioned at a sensor location in the right atrium **122**, as shown in FIG. **1**. As an example, the heart rhythm disorder can be a complex rhythm disorder AF, VF and polymorphic VT, or another heart rhythm disorder.

Similarly to example signal **200**, example signal **300** is for a time period between about 300 ms and about 900 ms. During this time period, the signal **300** is expected to have four (4) local activation onsets, e.g., activation onsets that originate locally to the sensor location in the heart **120** of sensor **106**. However, in the example signal **300** there are eleven (11) possible activation onsets **302-322**. Multiple deflections of short duration (shorter than shortest cycle length of about 100 ms) caused by the heart rhythm disorder makes the discernment of local activation onsets at the sensor location of sensor **104** as opposed to far-field activations or simply noise prohibitively difficult.

FIG. **4** illustrates an example array of sensors **400** of catheter **102** and an example selection of signals from the sensors to reconstruct cardiac activation information (e.g., activation onsets). The array **400** includes fifteen (15) example sensors for simplicity and clarity of the description. It is to be understood that the array **400** can include fewer or more sensors to

as may be determined to cover different portions of the heart **120**. In some embodiments or aspects, the array **400** can include **160** or more sensors.

The sensors of the array **400** are shown in example spatial arrangement with respect to the right atrium **122** of the heart **120**. Similarly, the array **400** can be spatially arranged in other chambers of the heart, e.g., left atrium, right ventricle, left ventricle, or for combinations of chambers including the endocardial or epicardial surfaces. In FIG. **4**, the spatial arrangement of electrodes in the array **400** is shown to be uniform and planar for simplicity and clarity of the description. However, the heart **120** is not a uniform or planar structure. Accordingly, the spatial arrangement of electrodes in the array **400** can be varied with respect to the shape of the heart **120** to improve detection of electric activity in the heart **120**.

In one example embodiment or aspect, catheter **102** of FIG. **1** can be a basket catheter with the example sensors of the array **400** disposed in spatial arrangements along splines **406-408** of the basket catheter **102**. Different catheters with various spatial arrangements of the sensors in the sensor array **400** can be used, such as spiral, radial spokes or other spatial arrangements.

Pairs of sensors (signals of sensors) in the array **400** are iteratively selected for processing as will be described in greater detail herein in order to reconstruct cardiac activation information (activation onsets) of the heart **120** in the right atrium **122**, or another chamber in which the array **400** may be disposed.

As illustrated at **402**, an analysis signal (**1**) is selected for processing. A reference signal (**2**)—a neighbor to the analysis signal (**1**)—is then selected to form a first pair that is processed to determine activation onsets in the analysis signal (**1**). Similarly, as illustrated at **404**, an analysis signal (**1**) is selected for processing. A reference signal (**2**)—another neighbor to the analysis signal (**1**)—is then selected to form a second pair that is processed to determine activation onsets in the analysis signal (**1**). The activation onsets from the first pair and the second pair of signals can be stored in memory of computing device **116** or database **118** of FIG. **1**. The neighboring sensors (signals) can but do not have to be adjacent, as will be described in greater detail below.

The selections and processing are repeated for the sensors of the array **400** (signals) that neighbor the analysis signal (**1**). The activation onsets in the analysis signal (**1**) for all pairs of signals can also be stored in memory of computing device **116** or database **118**. Thereafter, another analysis signal is selected and the selections and processing are repeated for that analysis signal. In this fashion, each of the plurality of analysis signals in array **400** is processed against its neighboring signals. The number of neighboring signals for a given analysis signal can be fewer or greater depending on the spatial arrangement of the sensors in the array **400**, the chamber of the heart analyzed and the heart rhythm disorder treated.

FIG. **5** illustrates example comparison pairs of signals from the sensors of the array **400** illustrated in FIG. **4**. Neighbor signals can include not only those signals that are immediately adjacent to the analysis signal but also those signals not adjacent to the analysis signal. Spatially separating the paired sensors can have the effect of spatially extending the area over which deflections are considered to be local activity. Local activity is therefore approximately defined by the separation of the paired sensors. As illustrated in example 1 of FIG. **5**, selected analysis signal (**1**) is processed against adjacent signals (**2**)-(5) and also against a non-adjacent signal (**6**). As further illustrated in example 2 of FIG. **5**, selected analysis signal (**1**) is processed against adjacent signals (**2**)-(5) and

also against a non-adjacent signals (6) and (7). While closest neighbor signals are preferred, neighbor signals in various spatial orientations with respect to the analysis signal can be used.

For each analysis signal, there could be a plurality of reference signals (e.g., four (4) reference signals or greater). A final activation onset in the analysis signal is determined with reference to or based on the combination of the reference signals' possible activation onsets. Specifically, the activation onsets determined from each pair can be referenced against each other to check for correspondence or association of activations in the analysis signal. An activation onset for the analysis signal is finalized based on the possible activation onsets of the referenced pairs of signals.

The final activation onset for the analysis signal can be determined in various ways. In one embodiment or aspect, the final activation onset for the analysis signal can be determined based on an average of the possible activation onsets from the various pairs of referenced signals. In another embodiment or aspect, the final activation onset for the analysis signal can be determined based on an average of the possible activation onsets from those pairs of signals in which a majority of the possible activation onsets are within a predetermined time interval of each other (e.g.,  $\pm 5$  ms). The time interval used can be chosen to be lower or higher. Alternatively, the final activation can also be determined by performing a "center-of-mass" calculation weighted by the significance value of each of the possible activation onsets in the majority, or by analysis of a predominant direction of activation onsets relative to sensor locations.

With reference to example 1 in FIG. 5, if an analysis signal has been determined to have possible activation onsets of 170 ms, 190 ms, 193 ms, 165 ms and 172 ms in connection with the five (5) reference signal pairs, respectively, then the final activation onset for the analysis signal can be determined to be  $(170+165+172)/3=169$  ms. The activation onsets of 190 ms and 193 ms that are outside the time interval can be discounted from the determination of the final activation onset for the analysis signal. The final activation onset determined for each signal can be saved in the database 118 of FIG. 1.

While in the forgoing examples for the sake of brevity and clarity, only one activation onset was determined for the analysis signal in connection with each reference signal, it should be understood that each signal (from a sensor of array 400) can represent multiple successive analysis intervals (e.g., activation cycles) as illustrated in FIG. 2, each of which can have an activation onset as determined based on the same time interval of multiple reference signals (neighboring sensors of array 400).

FIG. 6 is an illustration of an example signal pair comparison 600 of example analysis signal (SIG1) and example reference signal (SIG2). For example, the signals can be from comparison pair 402 (or comparison pair 404) illustrated in FIG. 4, or from any comparison pair illustrated in FIG. 5. It is noted that the signals are illustrative and occur during the same analysis interval. As noted herein, the signals can have multiple successive analysis intervals (e.g., activation cycles), as illustrated in FIG. 2.

The signals are processed at one or more successive time points (e.g., every millisecond, two milliseconds, or other time points) to determine whether there is a point of change in a derivative of the analysis signal with respect to a derivative of the reference signal above a threshold. The point of change can be determined from one or more of slope, amplitude, timing and shape for the first cardiac signal and the second cardiac signal. It is noted that in some embodiments or

aspects, processing of some time points can be omitted (e.g., every other time point or two of three time points). A first derivative (or second derivative can be used) is determined for each of the time points in the signals. A root mean squared is determined for each of the signals. For example, RMS1 and RMS2 are determined by taking a root mean squared of the derivatives for the entire signal of each of the signals (e.g., all activation cycles). RMS can be used to normalize the amplitude of the signals with respect to one another, such that amplitudes (e.g., voltage) of the deflections in the signals do not affect the processing of the signals as described below.

A time point (same time point or about the same time point) is successively selected from each of the signals (SIG1, SIG2) for consideration and processing. For each time point under consideration, a time increment 602, 604 in each signal starting at that time point can be considered. For example, a time increment of 10 ms can be used. Different time increments can be selected. A line which is pinned to the point under consideration in each signal and which provides the best fit to the time points in the time increment of each signal is determined. The determined lines represent the slopes (e.g., volts/ per second) of the signals for the selected time point. More specifically, the determined lines represent slopes of the signals at the selected time point for the same time increment (e.g., 10 ms). A significance value ( $\delta$ ) is determined with respect to the slopes.

The significance value can be determined by taking an absolute value of the first slope over its associated root mean squared value and subtracting an absolute value of the second slope over its associated root mean squared value. A determination is made as to whether the resulting ( $\delta$ )= $-0.461$  is above a significance threshold (e.g., 0.25). The significance threshold indicates that there is a potentially significant point of change (based on slopes) for the time point in the signals under consideration, e.g., that the derivatives diverge sufficiently from each other. In the example signal pair comparison 600, the significance value ( $\delta$ )= $-0.461$  is below the significance threshold of 0.25. The low significance value indicates that the deflection in SIG1 is far-field and not sufficiently local to a sensor location from which the signal originated, e.g., a sensor shown in FIG. 4. Accordingly, there is no potentially significant point of change in the example signal pair comparison 600.

As noted herein, the signals can have multiple successive analysis intervals (e.g., activation cycles), as illustrated in FIG. 2. In each analysis interval, it is possible to have zero, one or more potentially significant points of change as described above. The time point under consideration and the potentially significant point(s) of change can be recorded, such as in database 118.

FIG. 7 is an illustration of an example signal pair comparison 700 of example analysis signal (SIG1) and example reference signal (SIG2). Similarly, the signals can be from comparison pair 402 (or comparison pair 404) illustrated in FIG. 4, or from any comparison pair illustrated in FIG. 5. The signals are illustrative and occur during the same analysis interval. As noted herein, the signals can have multiple successive analysis intervals (e.g., activation cycles), as illustrated in FIG. 2.

The signals are processed at one or more successive time points to determine whether there is a point of change in a derivative of the analysis signal with respect to a derivative of the reference signal above a threshold. In some embodiments or aspects, processing of some time points can be omitted (e.g., every other time point or two of three time points). A first derivative (or second derivative) is determined for each of the time points in the signals. A root mean squared is further

determined for each of the signals. A time point (same time point or about the same time point) is successively selected from each of the signals (SIG1, SIG2) for consideration and processing. For each time point under consideration, a time increment **702, 704** (e.g., 10 ms) in each signal starting at that time point can be considered. A line which is pinned to the point under consideration in each signal and which provides the best fit to the time points in the time increment of each signal is determined. The determined lines represent the slopes (e.g., volts/per second) of the signals for the selected time point. More specifically, the determined lines represent the slopes at the selected time point for the same time increment. A significance value ( $\delta$ ) is determined with respect to the slopes.

The significance value can be determined by taking an absolute value of the first slope over its associated root mean squared value and subtracting an absolute value of the second slope over its associated root mean squared value. A determination is made as to whether the resulting ( $\delta$ )= $-0.063$  is above a significance threshold (e.g., 0.25). In the example signal pair comparison **700**, the significance value ( $\delta$ )= $-0.063$  is well below the significance threshold of 0.25. The low significance value indicates low amplitude noise. Accordingly, there is no potentially significant point of change in the example signal pair comparison **700**.

A noise level can be defined as fraction of the significance threshold or can be defined programmatically in various ways. For example, noise level can be one-tenth (0.025) of the significance threshold (0.25). A different fraction level can be selected. As another example, the noise level can be defined as a Gaussian standard deviation of a plurality of significance values. Other ways of defining the noise level are contemplated. It is noted that the significance threshold (e.g., 0.25) is higher than the noise level that can be associated with the analysis signal and reference signal in the example signal pair comparison **700**. Accordingly, a point of change at or below noise level can be associated with one or more signals from other regions of a heart, respiratory system, gastrointestinal tract, neurological system as well as electronic interference.

As noted herein, the signals can have multiple successive analysis intervals (e.g., activation cycles) and in each analysis interval, it is possible to have zero, one or more potentially significant points of change as described above. The time point under consideration and the potentially significant point(s) of change can be recorded, such as in database **118**.

FIG. **8** is an illustration of an example signal pair comparison **800** of example analysis signal (SIG1) and example reference signal (SIG2) utilizing a composite signal. As in the other examples, the signals can be from comparison pair **402** (or comparison pair **404**) illustrated in FIG. **4**, or from any comparison pair illustrated in FIG. **5**. The signals are illustrative and occur during the same analysis interval. As noted herein, the signals can have multiple successive analysis intervals (e.g., activation cycles), as illustrated in FIG. **2**.

The signals are processed at one or more successive time points to determine whether there is a point of change in a derivative of the analysis signal with respect to a derivative of the reference signal above a threshold. In some embodiments or aspects, processing of some time points can be omitted (e.g., every other time point or two of three time points). A first derivative (zero order derivative or second derivative) is determined for each of the time points in the signals. A root mean squared is further determined for each of the signals. A time point (same time point or about the same time point) is successively selected from each of the signals (SIG1, SIG2) for consideration and processing. For each time point under consideration, a time increment **802, 804** (e.g., 10 ms) in each

signal starting at that time point can be used. A line which is pinned to the point under consideration in each signal and which provides the best fit to the time points in the time increment of each signal is determined. The determined lines represent the slopes (e.g., volts/per second) of the signals for the selected time point. More specifically, the determined lines represent the slopes of the signals at the selected time point for same time increment. A significance value ( $\delta$ ) is determined with respect to the slopes.

In some embodiments or aspects, the significance value can be determined by taking an absolute value of the first slope over its associated root mean squared value and subtracting an absolute value of the second slope over its associated root mean squared value. A determination is made as to whether the resulting ( $\delta$ )= $0.546$  is above a significance threshold (e.g., 0.25). In the example signal pair comparison **800**, the significance value ( $\delta$ )= $0.546$  is determined to be above the significance threshold of 0.25.

Accordingly, there is a potentially significant point of change in the example signal pair comparison **800** at the time point under consideration. As noted herein, the signals can have multiple successive analysis intervals (e.g., activation cycles) and in each analysis interval, it is possible to have zero, one or more potentially significant points of change as described above. The time point under consideration and the potentially significant point(s) of change can be recorded, such as in database **118**.

In other embodiments or aspects, the significance value can be determined with respect to a composite signal. Specifically, a composite signal (COMP) is computed by subtracting SIG2 (reference signal) from SIG1 (analysis signal), e.g.,  $COMP = SIG2 - SIG1$ . The composite signal can represent a bipolar signal (COMP) of constituent unipolar signals (SIG1, SIG2). In alternate embodiments or aspects, the composite signal COMP can also be computed by adding signals SIG1 and SIG2. The signals in the signal pair comparison **800** are illustrative and occur during the same analysis interval. As noted herein, the signals can have multiple successive analysis intervals (e.g., activation cycles), as illustrated in FIG. **2**.

The signals SIG1, SIG2 are processed at one or more successive time points with respect to the composite signal COMP to determine whether there is a point of change in a derivative of the analysis signal with respect to a derivative of the reference signal above a threshold. A first derivative (or second derivative) is determined for each of the time points in the signals, SIG1, SIG2, COMP. A time point (same time point or about the same time point) is successively selected from each of the signals (SIG1, SIG2, COMP) for consideration and processing. For each time point under consideration, a time increment **802, 804, 806** (e.g., 10 ms) in each signal starting at that time point can be considered. A line which is pinned to the point under consideration in each signal and which provides the best fit to the time points in the time increment of each signal is determined. The determined lines represent the slopes (e.g., volts/per second) of the signals for the selected time point. More specifically, the determined lines represent the slopes of the signals at the selected time point for the same time increment. A significance value ( $\delta$ ) is determined with respect to the slopes.

In the embodiments or aspects employing the composite signal, the significance value ( $\delta$ ) can be determined by a ratio taking an absolute value of the second slope and subtracting an absolute value of the composite slope, and dividing by a logarithm of a result of an absolute value the first slope subtracting an absolute value of the composite slope. The resulting significance value for the time point under consideration is ( $\delta$ )= $31.63$ . Significance values can be computed for

all points under consideration. A significance threshold can be determined to be an average of the computed significance values ( $\delta$ ) plus a standard deviation. Thereafter, only those significance values ( $\delta$ ) that are above the significance threshold can be considered to be potentially significant points of change for the comparison pair **800**. For the example signals in the signal pair comparison **800** of FIG. **8**, the determined significance threshold can be 10. It is noted that the significance value(s) that is above the significance threshold generally extends substantially above the significance threshold. For example, a significance value ( $\delta$ )—having the largest ratio—can therefore be selected.

Accordingly, there is a potentially significant point of change in the example signal pair comparison **800** at the time point under consideration. As noted herein, the signals can have multiple successive analysis intervals (e.g., activation cycles) and in each analysis interval, it is possible to have zero, one or more potentially significant points of change as described above. The time point under consideration and the potentially significant point(s) of change can be recorded, such as in database **118**.

FIG. **9** is a flowchart that illustrates an example method **900** of reconstructing cardiac activation information (activation onset) associated with heart rhythm disorders. The example method **900** can be performed by the computing device **116** illustrated in FIG. **1**. More specifically, the example method **900** starts at operation **902** at which signals are received by the computing device **116** via signal processing device **114** from sensors disposed in the heart **120**. For example, signals can be received from sensors of the sensor array **400** disposed in the right atrium **122** of the heart **120**, as shown in FIGS. **1** and **4**. In some embodiments or aspects, at least a portion of the signals from the sensors can be recorded by signal processing device **114** and then provided to computing device **116**.

At operation **904**, a first signal (analysis signal) is selected. At operation **906**, a second signal (reference signal) is selected. Selection of the analysis signal and the reference signal can be performed as described in greater detail with reference to FIGS. **4** and **5**. In some embodiments or aspects, a root mean squared (RMS) can be determined for the first signal and for the second signal. At operation **908**, a time interval over which the first signal and the second signal are to be compared is selected. The time interval can be selected to be an activation cycle (e.g., 100 ms to 300 ms) as described in FIG. **2**. In some embodiments or aspects, the time interval can be determined by a dominant frequency analysis or other analysis of the average cycle length of the first (analysis) signal. A default time interval of 200 ms can be used if the time interval cannot be determined computationally. In other embodiments or aspects, the time interval can be selected manually, computationally by a different analysis method, from a database that catalogs such time intervals for patients of a certain age, gender and type of heart rhythm disorder, or defaulted to a value between about 100 ms and about 300 ms.

In some embodiments or aspects, a composite signal can be determined based on the selected first signal and the second signal, such as by subtracting or adding the signals as described with reference to FIG. **8**.

At operation **910**, a time point is selected for consideration in the selected time interval. The same or about the same time point is selected for consideration in each signal (e.g., first signal and second signal). At operation **912**, derivatives are calculated for a time increment (e.g., 10 ms) extending from the point of consideration in each signal. In those embodiments or aspects that use a composite signal, a derivative is also calculated for a time increment (e.g., 10 ms) extending from a time point of consideration in the composite signal.

The time point of consideration in the composite signal is the same or about the same as in the other signals (e.g., first signal and second signal).

At operation **914**, a determination is made as to whether all points in the selected time interval have been processed. If it is determined that all point in the selected time interval were processed, the method **900** continues at operation **916**. Alternatively, the method **900** performs operations **910**, **912** until all points in the selected time interval are determined to be processed at operation **914**.

At operation **916**, points of change between the derivatives of the first signal with respect to the derivatives of the second signal are determined in the time interval under consideration. For example, a significance value ( $\delta$ ) can be determined at each point of change as described with reference to FIGS. **6-8**.

At operation **918**, a determination is made as to whether there is a point(s) of change in the derivative of the first cardiac signal with respect to the derivative of the second cardiac signal above a threshold. For example, it can be determined whether the significance value ( $\delta$ ) at the point of change is above the threshold. In some embodiments or aspects that do not use a composite signal, the threshold can be 0.25 (or another value) as described with reference to FIGS. **6-8**, while in those embodiments or aspects that use a composite signal, the threshold can be computed as an average value plus a standard deviation of all points of change as described with reference to FIG. **8**.

If it is determined that there is a point(s) of change above the threshold, the method **900** continues at operation **920** where the significant point(s) of change is recorded (selected) as a possible activation onset(s) for the time interval under consideration in the first (analysis) signal. If however, it is determined that there is no point of change above the threshold (no significant point of change), the method **900** continues at operation **924** where the first signal is compared over the time interval to a catalog of reference signals. For example, the catalog of reference signals for heart rhythm disorders can be maintained in database **118**. At operation **926**, a determination is made as to whether there is a match to a reference signal in the database. The comparison can be based on at least one characteristic of the first signal to at least one characteristic of the reference signal, such as shape, slope, amplitude, frequency and/or timing. Other characteristics can be used together with or instead of the enumerated characteristics.

If there is no match to a reference signal at operation **926**, the method **900** continues at operation **922**. Alternatively, the method **900** continues at operation **928** where the point(s) of change in the time interval under consideration is recorded (selected), which would correspond to activation onset(s) in the reference signal that was matched.

At operation **922**, a determination is made as to whether all time intervals in the signals have been processed. If it is determined that all time intervals have not been processed, the method **900** continues to perform operations **908-922** to process subsequent time intervals until it is determined that all time intervals have been processed. The subsequent time interval can be determined from the point(s) of change that represents the possible activation onset at **920**. Specifically, if only one point of change (above the threshold) is recorded at **920**, then the next time interval (e.g., 100 ms to 300 ms) starts at the onset time associated with the point of change plus a half of a cycle length (e.g., 50 ms to 150 ms). If there are multiple points of change, then the onset time associated with the largest point of change (significance value) is used to determine the next time interval for operations **908-922**. It is

noted that the determination of the next time interval can be extended to consider significant points of change from all second (reference) signals for the same time interval under consideration. However, if it is determined that all time intervals have been processed at operation 922, the method 900 continues at operation 930.

At operation 930, a determination is made as to whether all second (reference) signals have been processed in association with the selected first (analysis signal). If it is determined that all second signals have not been processed, the method 900 continues to perform operations 906-930 until it is determined that all second (reference) signals have been processed for the first (analysis) signal. However, if it is determined that all second signals have been processed, the method 900 continues to operation 932.

At operation 932, an activation onset(s) is assigned in the first signal at the point(s) of change to define cardiac activation(s) indicating a beat(s) in the first signal if it is determined (at operation 918) that the point(s) of change is above the threshold. Similarly, at operation 932 an activation onset(s) can be assigned in the first signal at the point(s) of change to define cardiac activation(s) indicating a beat(s) in the first signal based on a matched reference signal (at operation 928). More specifically, activation onsets are assigned to the time intervals of the first signal based on the recorded (or significant) point(s) of change of the first signal with reference to the second signal(s). That is, an activation onset is assigned to each time interval in the first (analysis) signal based possible activation onset(s) associated with the significant point(s) of change in the same time interval of the second (reference) signal(s). As described with reference to FIG. 5, the activation onset for the time interval of the first (analysis) signal can be determined based on an average of the activation onsets with reference to the second (reference) signals. In another embodiment or aspect, the activation onset for the time interval of the first signal can be determined based on an average of activation onsets with reference to those second signals in which a majority of activation onsets are within a predetermined time interval of each other (e.g.,  $\pm 5$  ms). The assigned onset can be recorded for each interval in the first (analysis) signal such as in database 118.

At operation 934, a determination is made as to whether all signals have been processed or analyzed as first (analysis) signals against second (reference) signals. If it is determined that all signals have not been processed, then the method 900 continues to perform operations 904-932 until all signals have been processed. Alternatively, if it is determined that all signals have been processed, the method 900 ends at operation 936.

At the conclusion of the method 900, signals collected from the heart 120 have been reconstructed with cardiac activation information (activation onsets) such that a cause of the heart rhythm disorder can be determined. More specifically, unipolar electrograms or monophasic action potentials (MAPs) can be mapped to the reconstructed activation onsets of the signals to show unipolar or MAP sequences or representations for the signals. An activation map or pattern can be constructed from these unipolar voltage or MAP voltage representations of the signals to locate the cause of the heart rhythm disorder. An example MAP representation and example activation map are illustrated in FIG. 11.

FIG. 10 is an illustration of an example signal pair comparison 1000 of analysis signal (SIG1) and reference signal (SIG2) that can be processed in accordance with method 900 of FIG. 9 to assign an activation onset 1004. As illustrated in comparison 1000, a time interval 1002 (e.g., 100 ms-300 ms) is selected for comparison and processing. In some example

embodiments or aspects, the signals in the time interval (SIG1, SIG2, COMP) are smoothed, such as via median filter. Significance values ( $\delta$ ) are determined for the points of changes in the signals' first or second derivative, as described herein with reference to FIGS. 1-9. As illustrated in signal pair comparison 1000, point of change 1012 in SIG1 that is above threshold 1010 is assigned as the activation onset 1004 for the time interval 1002 in SIG1 based on the first derivative. Alternatively, point of change 1014 in SIG1 that is above threshold 1010 is assigned as the activation onset 1004 for the time interval 1002 in SIG1 based on the second derivative. Subsequent time intervals are selected and activation onsets are assigned as described herein with reference to FIGS. 1-9 until the analysis signal (SIG1) is processed.

FIG. 11 is an illustration of an example mapping 1100 of processed signals in accordance with FIGS. 1-10. Raw signal 1100 represents a signal that is processed to assign activation onsets (vertical lines) as described herein. For reference purposes, a composite signal 1102 is shown, which results from the raw (analysis) signal 1100 and another (reference) signal (not shown). A monophasic action potential (MAP) voltage representation is generated from for each processed signal 1100. Multiple signals are processed as described herein and MAPs generated based on the processed signals. The electrical activity of all MAPs is mapped in a sequence of example activation mappings 1106 to show activation onsets 1108, 1110, 1112 and 1114 at each time interval, respectively. These mappings can be displayed by computing device 116. Although only four mapping are shown for illustrative purposes, there can be fewer or greater number of mappings 1106 based on the time intervals represented in the signals.

As shown by the arrows in the example mappings 1106 (e.g., activation onsets 1108-1114), the electrical activity indicates a rotational activation pattern of activation onsets (rotor) in the heart rhythm disorder. At least a portion of the area of the heart 120 indicated by the rotational activation pattern indicated by the arrows in FIG. 11 can be treated to eliminate the cause of the heart rhythm disorder, and therefore the heart rhythm disorder itself. Such treatment may be delivered by ablation using various energy sources (including but not limited to radiofrequency, cryoenergy, microwave, and ultrasound), gene therapy, stem cell therapy, pacing stimulation, drug or other therapy. It is noted that the MAP representation and activation map are examples to illustrate a rotational activation pattern. Other activation patterns can result from different example signals collected by the sensors from the heart 120.

FIG. 12 is a block diagram of an illustrative embodiment of a general computer system 1200. The computer system 1200 can be the signal processing device 114 and the computing device 116 of FIG. 1. The computer system 1200 can include a set of instructions that can be executed to cause the computer system 12800 to perform any one or more of the methods or computer based functions disclosed herein. The computer system 1200, or any portion thereof, may operate as a standalone device or may be connected, e.g., using a network or other connection, to other computer systems or peripheral devices. For example, the computer system 1200 may be operatively connected to signal processing device 114 and analysis database 118.

The computer system 1200 may also be implemented as or incorporated into various devices, such as a personal computer (PC), a tablet PC, a personal digital assistant (PDA), a mobile device, a palmtop computer, a laptop computer, a desktop computer, a communications device, a control system, a web appliance, or any other machine capable of executing a set of instructions (sequentially or otherwise) that

specify actions to be taken by that machine. Further, while a single computer system **1200** is illustrated, the term “system” shall also be taken to include any collection of systems or sub-systems that individually or jointly execute a set, or multiple sets, of instructions to perform one or more computer functions.

As illustrated in FIG. **12**, the computer system **1200** may include a processor **1202**, e.g., a central processing unit (CPU), a graphics-processing unit (GPU), or both. Moreover, the computer system **1200** may include a main memory **1204** and a static memory **1206** that can communicate with each other via a bus **1226**. As shown, the computer system **1200** may further include a video display unit **1210**, such as a liquid crystal display (LCD), an organic light emitting diode (OLED), a flat panel display, a solid state display, or a cathode ray tube (CRT). Additionally, the computer system **1200** may include an input device **1212**, such as a keyboard, and a cursor control device **1214**, such as a mouse. The computer system **1200** can also include a disk drive unit **1216**, a signal generation device **1222**, such as a speaker or remote control, and a network interface device **1208**.

In a particular embodiment or aspect, as depicted in FIG. **12**, the disk drive unit **1216** may include a computer-readable medium **1218** in which one or more sets of instructions **1220**, e.g., software, can be embedded. Further, the instructions **1220** may embody one or more of the methods or logic as described herein. In a particular embodiment or aspect, the instructions **1220** may reside completely, or at least partially, within the main memory **1204**, the static memory **1206**, and/or within the processor **1202** during execution by the computer system **1200**. The main memory **1204** and the processor **1202** also may include computer-readable media.

In an alternative embodiment or aspect, dedicated hardware implementations, such as application specific integrated circuits, programmable logic arrays and other hardware devices, can be constructed to implement one or more of the methods described herein. Applications that may include the apparatus and systems of various embodiments or aspects can broadly include a variety of electronic and computer systems. One or more embodiments or aspects described herein may implement functions using two or more specific interconnected hardware modules or devices with related control and data signals that can be communicated between and through the modules, or as portions of an application-specific integrated circuit. Accordingly, the present system encompasses software, firmware, and hardware implementations.

In accordance with various embodiments or aspects, the methods described herein may be implemented by software programs tangibly embodied in a processor-readable medium and may be executed by a processor. Further, in an exemplary, non-limited embodiment or aspect, implementations can include distributed processing, component/object distributed processing, and parallel processing. Alternatively, virtual computer system processing can be constructed to implement one or more of the methods or functionality as described herein.

It is also contemplated that a computer-readable medium includes instructions **1220** or receives and executes instructions **1220** responsive to a propagated signal, so that a device connected to a network **1224** can communicate voice, video or data over the network **1224**. Further, the instructions **1220** may be transmitted or received over the network **1224** via the network interface device **1208**.

While the computer-readable medium is shown to be a single medium, the term “computer-readable medium” includes a single medium or multiple media, such as a centralized or distributed database, and/or associated caches and

servers that store one or more sets of instructions. The term “computer-readable medium” shall also include any medium that is capable of storing, encoding or carrying a set of instructions for execution by a processor or that cause a computer system to perform any one or more of the methods or operations disclosed herein.

In a particular non-limiting, example embodiment or aspect, the computer-readable medium can include a solid-state memory, such as a memory card or other package, which houses one or more non-volatile read-only memories. Further, the computer-readable medium can be a random access memory or other volatile re-writable memory. Additionally, the computer-readable medium can include a magneto-optical or optical medium, such as a disk or tapes or other storage device to capture carrier wave signals, such as a signal communicated over a transmission medium. A digital file attachment to an e-mail or other self-contained information archive or set of archives may be considered a distribution medium that is equivalent to a tangible storage medium. Accordingly, any one or more of a computer-readable medium or a distribution medium and other equivalents and successor media, in which data or instructions may be stored, are included herein.

In accordance with various embodiments or aspects, the methods described herein may be implemented as one or more software programs running on a computer processor. Dedicated hardware implementations including, but not limited to, application specific integrated circuits, programmable logic arrays, and other hardware devices can likewise be constructed to implement the methods described herein. Furthermore, alternative software implementations including, but not limited to, distributed processing or component/object distributed processing, parallel processing, or virtual machine processing can also be constructed to implement the methods described herein.

It should also be noted that software that implements the disclosed methods may optionally be stored on a tangible storage medium, such as: a magnetic medium, such as a disk or tape; a magneto-optical or optical medium, such as a disk; or a solid state medium, such as a memory card or other package that houses one or more read-only (non-volatile) memories, random access memories, or other re-writable (volatile) memories. The software may also utilize a signal containing computer instructions. A digital file attachment to e-mail or other self-contained information archive or set of archives is considered a distribution medium equivalent to a tangible storage medium. Accordingly, a tangible storage medium or distribution medium as listed herein, and other equivalents and successor media, in which the software implementations herein may be stored, are included herein.

Thus, system and method to reconstruct cardiac activation information have been described. Although specific example embodiments or aspects have been described, it will be evident that various modifications and changes may be made to these embodiments or aspects without departing from the broader scope of the invention. Accordingly, the specification and drawings are to be regarded in an illustrative rather than a restrictive sense. The accompanying drawings that form a part hereof, show by way of illustration, and not of limitation, specific embodiments or aspects in which the subject matter may be practiced. The embodiments or aspects illustrated are described in sufficient detail to enable those skilled in the art to practice the teachings disclosed herein. Other embodiments or aspects may be utilized and derived therefrom, such that structural and logical substitutions and changes may be made without departing from the scope of this disclosure. This Detailed Description, therefore, is not to be taken in a limiting sense, and the scope of various embodiments or

aspects is defined only by the appended claims, along with the full range of equivalents to which such claims are entitled.

Such embodiments or aspects of the inventive subject matter may be referred to herein, individually and/or collectively, by the term “invention” merely for convenience and without intending to voluntarily limit the scope of this application to any single invention or inventive concept if more than one is in fact disclosed. Thus, although specific embodiments or aspects have been illustrated and described herein, it should be appreciated that any arrangement calculated to achieve the same purpose may be substituted for the specific embodiments or aspects shown. This disclosure is intended to cover any and all adaptations or variations of various embodiments or aspects. Combinations of the above embodiments or aspects, and other embodiments or aspects not specifically described herein, will be apparent to those of skill in the art upon reviewing the above description.

The Abstract is provided to comply with 37 C.F.R. §1.72(b) and will allow the reader to quickly ascertain the nature and gist of the technical disclosure. It is submitted with the understanding that it will not be used to interpret or limit the scope or meaning of the claims.

In the foregoing description of the embodiments or aspects, various features are grouped together in a single embodiment for the purpose of streamlining the disclosure. This method of disclosure is not to be interpreted as reflecting that the claimed embodiments or aspects have more features than are expressly recited in each claim. Rather, as the following claims reflect, inventive subject matter lies in less than all features of a single disclosed embodiment or aspect. Thus the following claims are hereby incorporated into the Detailed Description, with each claim standing on its own as a separate example embodiment or aspect. It is contemplated that various embodiments or aspects described herein can be combined or grouped in different combinations that are not expressly noted in the Detailed Description. Moreover, it is further contemplated that claims covering such different combinations can similarly stand on their own as separate example embodiments or aspects, which can be incorporated into the Detailed Description.

The invention claimed is:

1. A method of processing cardiac activation information, the method comprising:

accessing a first cardiac signal and a second cardiac signal obtained from a patient;

processing the first cardiac signal and the second cardiac signal to determine whether there is a point of change in the first cardiac signal at which a derivative of the first cardiac signal diverges with respect to a derivative of the second cardiac signal above a threshold; and

assigning an activation onset time in the first cardiac signal at the point of change to define a cardiac activation if the point of change is in the first cardiac signal.

2. The method of claim 1, wherein the derivative of the first cardiac signal and the derivative of the second cardiac signal are selected from the group consisting of a zero order derivative, a first order derivative, a second order derivative, a higher order derivative, and combinations thereof.

3. The method of claim 1, wherein the derivative of the first cardiac signal and the derivative of the second cardiac signal are zero order derivatives.

4. The method of claim 1, wherein the derivative of the first cardiac signal and the derivative of the second cardiac signal are first order derivatives.

5. The method of claim 1, wherein the derivative of the first cardiac signal and the derivative of the second cardiac signal are second order derivatives.

6. The method of claim 1, further comprising obtaining the first cardiac signal and the second cardiac signal from the patient using a first sensor and a second sensor, respectively.

7. The method of claim 6, wherein the first cardiac signal and the second cardiac signal are obtained contemporaneously from the patient.

8. The method of claim 1, wherein the point of change is determined at about the same time point for the first cardiac signal and the second cardiac signal.

9. The method of claim 1, wherein the point of change is determined from one or more of slope, amplitude, timing and shape for the first cardiac signal and the second cardiac signal.

10. The method of claim 1, wherein determination of the point of change comprises:

forming a composite cardiac signal from the first cardiac signal and the second cardiac signal;

determining ratio values at a plurality of points in the first cardiac signal, each ratio value representing a difference between the derivative of the second cardiac signal and a derivative of the composite cardiac signal to a difference between derivative of the first cardiac signal and the derivative of the composite cardiac signal; and

selecting as the point of change in the first cardiac signal a point having a largest ratio value from the determined ratio values.

11. The method of claim 1, wherein the threshold is higher than a noise level associated with the first cardiac signal and the second cardiac signal.

12. The method of claim 11, wherein a point of change at or below the noise level is associated with one or more signals from a heart, respiratory system, gastrointestinal tract, neurological system and electronic interference.

13. The method of claim 1, further comprising:

matching at least one characteristic of the first cardiac signal to at least one characteristic of a reference cardiac signal in a catalog of cardiac signals if the point of change is not in the first cardiac signal; and

assigning an activation onset time in the first cardiac signal as an activation onset time of the reference cardiac signal to define a cardiac activation in the first cardiac signal.

14. The method of claim 1, further comprising performing accessing, processing and assigning to define multiple cardiac activations in the first cardiac signal.

15. The method of claim 1, further comprising iteratively accessing the first cardiac signal and the second cardiac signal from a plurality of cardiac signals.

16. The method of claim 1, further comprising:

iteratively accessing pairs of cardiac signals from a plurality of cardiac signals, each pair having a first cardiac signal and different second cardiac signal;

performing processing and assigning for each of the pairs to define multiple cardiac activations in the first cardiac signal in each of the pairs; and

reconstructing a cardiac activation pattern based on assigned activation onset times of cardiac activations from the plurality of cardiac signals to indicate a source of a cardiac rhythm disorder.

17. The method of claim 16, further comprising displaying the cardiac activation pattern as reconstructed to facilitate treatment of cardiac tissue at the source to treat the cardiac rhythm disorder.

18. A system to process cardiac activation information, the system comprising:

at least one computing device to:

access a first cardiac signal and a second cardiac signal obtained from a patient;

21

process the first cardiac signal and the second cardiac signal to determine whether there is a point of change in the first cardiac signal at which a derivative of the first cardiac signal diverges with respect to a derivative of the second cardiac signal above a threshold; and

assign an activation onset time in the first cardiac signal at the point of change to define a cardiac activation if the point of change is in the first cardiac signal.

19. The system of claim 18, wherein the derivative of the first cardiac signal and the derivative of the second cardiac signal are one of a zero order derivative, a first order derivative, a second order derivative, and a higher order derivative, and combinations thereof.

20. The system of claim 18, wherein the derivative of the first cardiac signal and the derivative of the second cardiac signal are zero order derivatives.

21. The system of claim 18, wherein the derivative of the first cardiac signal and the derivative of the second cardiac signal are first order derivatives.

22. The system of claim 18, wherein the derivative of the first cardiac signal and the derivative of the second cardiac signal are second order derivatives.

23. The system of claim 18, further comprising a computer readable medium comprising instructions, which when executed by the at least one computing device, cause the at least one computing device to access, process and assign.

24. The system of claim 18, wherein the point of change is determined at about the same time point for both the first cardiac signal and the second cardiac signal.

25. The system of claim 18, wherein the point of change is determined from one or more of slope, amplitude, timing and shape for the first cardiac signal and the second cardiac signal.

26. The system of claim 18, wherein the at least one computing device is further to:

form a composite cardiac signal from the first cardiac signal and the second cardiac signal;

determine ratio values at a plurality of points in the first cardiac signal, each ratio value representing a difference between the derivative of the second cardiac signal and a derivative of the composite cardiac signal to a difference between the derivative of the first cardiac signal and the derivative of the composite cardiac signal; and

22

select as the point of change in the first cardiac signal a point having a largest ratio value from the determined ratio values.

27. The system of claim 18, wherein the at least one computing device is further to:

match at least one characteristic of the first cardiac signal to at least one characteristic of a reference cardiac signal in a catalog of cardiac signals if the point of change is not in the first cardiac signal; and

assign an activation onset time in the first cardiac signal as an onset time of the reference cardiac signal to define a cardiac activation in the first cardiac signal.

28. The system of claim 18, wherein the at least one computing device is further to access, process and assign to define multiple cardiac activations in the first cardiac signal.

29. The system of claim 18, wherein the at least one computing device is further to iteratively access the first cardiac signal and the second cardiac signal from a plurality of obtained cardiac signals.

30. The system of claim 18, further comprising a catheter with at least a first sensor and a second sensor to obtain from the patient the first cardiac signal and the second cardiac signal, respectively.

31. The system of claim 30, wherein the first cardiac signal and the second cardiac signal are obtained contemporaneously from the patient.

32. The system of claim 18, wherein the at least one computing device is further to:

iteratively access pairs of cardiac signals from a plurality of cardiac signals obtained from the patient, each pair having a first cardiac signal and different second cardiac signal;

process and assign for each of the pairs to define multiple cardiac activations in the first cardiac signal in each of the pairs;

reconstruct a cardiac activation pattern based on assigned activation onset times of cardiac activations from the plurality of cardiac signals to indicate a source of a cardiac rhythm disorder.

33. The system of claim 32, wherein the at least one computing device is further to display the cardiac activation pattern as reconstructed to facilitate treatment of cardiac tissue at the source to treat the cardiac rhythm disorder.

\* \* \* \* \*

专利名称(译)	用于重建心脏激动信息的系统和方法		
公开(公告)号	<a href="#">US9055876</a>	公开(公告)日	2015-06-16
申请号	US14/074619	申请日	2013-11-07
[标]申请(专利权)人(译)	托佩拉公司 加利福尼亚大学董事会		
申请(专利权)人(译)	TOPERA INC. 加利福尼亚大学董事会		
当前申请(专利权)人(译)	加利福尼亚大学董事会 TOPERA INC. 美洲的美国为代表的退伍军人事务署		
[标]发明人	NARAYAN SANJIV BRIGGS CAREY ROBERT		
发明人	NARAYAN, SANJIV BRIGGS, CAREY ROBERT		
IPC分类号	A61B3/12 A61B5/0464 A61B5/00 A61B5/0205 A61B5/046 A61B5/042 A61B5/04 A61B5/0452		
CPC分类号	A61B5/04011 A61B5/0422 A61B5/0452 A61B5/7239 A61B5/0205 A61B5/04012 A61B5/046 A61B5/0464 A61B5/7203 A61B2562/046 A61B5/02405 A61B5/0255 A61B5/7217 A61B5/7246 A61B5/7278 A61B5/7282 A61B5/742 A61B5/0002 A61B5/0036 A61B5/4836 A61B5/6852 A61B5/743 A61B18/02 A61B18/12 A61B18/18 A61B2018/00577		
优先权	61/481607 2011-05-02 US		
其他公开文献	US20140066787A1		
外部链接	<a href="#">Espacenet</a> <a href="#">USPTO</a>		

摘要(译)

公开了处理心脏激动信息的示例系统和方法。该方法包括访问从患者获得的第一心脏信号和第二心脏信号。处理第一心脏信号和第二心脏信号以确定第一心脏信号中是否存在第一心脏信号的变化点，其中第一心脏信号的导数相对于高于阈值的第二心脏信号的导数发散。如果变化点在第一心脏信号中，则在变化点处的第一心脏信号中分配激活开始时间以定义心脏激动。

