



US 20150351556A1

(19) **United States**  
(12) **Patent Application Publication**  
**Franceschetti et al.**

(10) **Pub. No.: US 2015/0351556 A1**  
(43) **Pub. Date: Dec. 10, 2015**

(54) **BED DEVICE SYSTEM AND METHODS**

*A61B 5/00* (2006.01)

(71) Applicant: **Morphy Inc.**, San Francisco, CA (US)

*A61B 5/08* (2006.01)

*A61B 5/01* (2006.01)

(72) Inventors: **Matteo Franceschetti**, San Francisco, CA (US); **Massimo Andreasi Bassi**, San Francisco, CA (US)

*A61B 5/11* (2006.01)

*A47G 9/02* (2006.01)

*A61B 5/0205* (2006.01)

(21) Appl. No.: **14/732,646**

(52) **U.S. Cl.**

CPC ..... *A47C 21/048* (2013.01); *A47G 9/0238*

(2013.01); *A47C 21/044* (2013.01); *H05B*

*1/0272* (2013.01); *A61B 5/0205* (2013.01);

*A61B 5/08* (2013.01); *A61B 5/01* (2013.01);

*A61B 5/11* (2013.01); *A61B 5/4812* (2013.01)

(22) Filed: **Jun. 5, 2015**

**Related U.S. Application Data**

(60) Provisional application No. 62/008,480, filed on Jun. 5, 2014, provisional application No. 62/024,945, filed on Jul. 15, 2014, provisional application No. 62/159,177, filed on May 8, 2015, provisional application No. 62/161,142, filed on May 13, 2015.

(57)

**ABSTRACT**

Introduced are a bed device system and methods for: gathering human biological signals, such as heart rate, breathing rate, or temperature; analyzing the gathered human biological signals; and controlling the bed device system, e.g., a temperature of the bed device, based on the analysis.

**Publication Classification**

(51) **Int. Cl.**

*A47C 21/04* (2006.01)

*H05B 1/02* (2006.01)

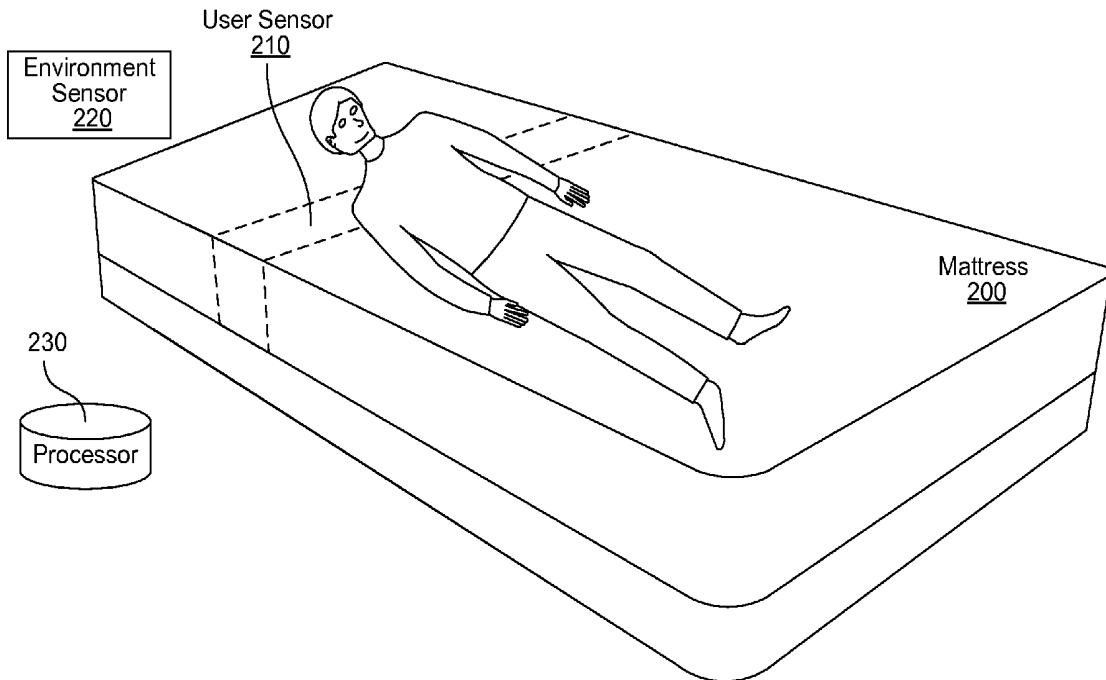

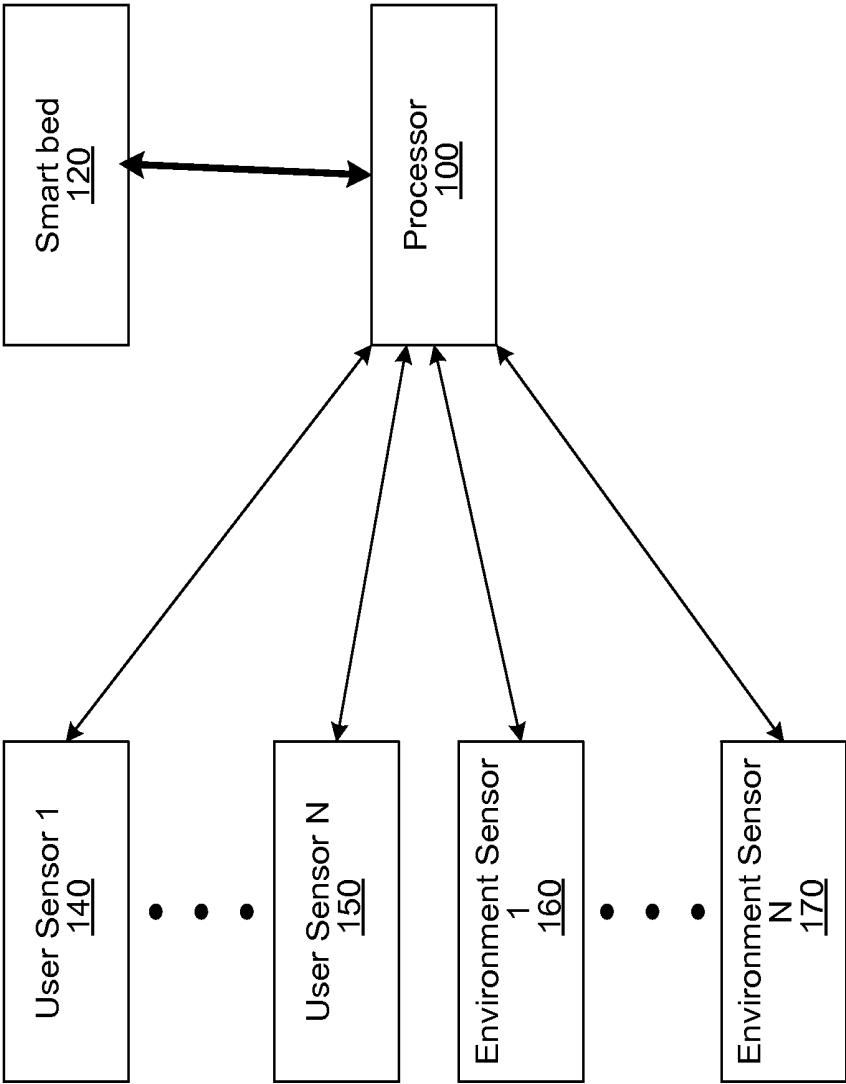

**FIG. 1**

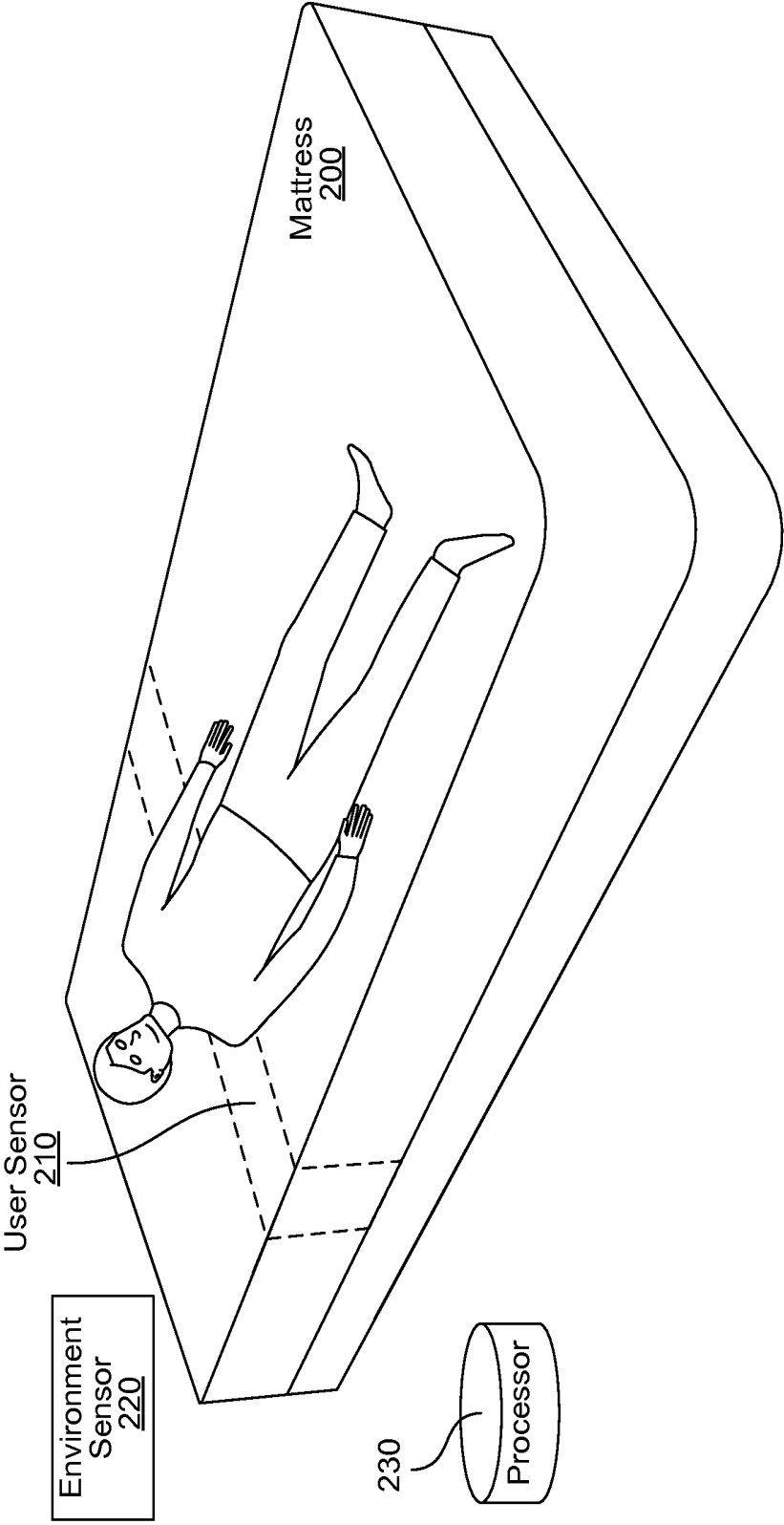
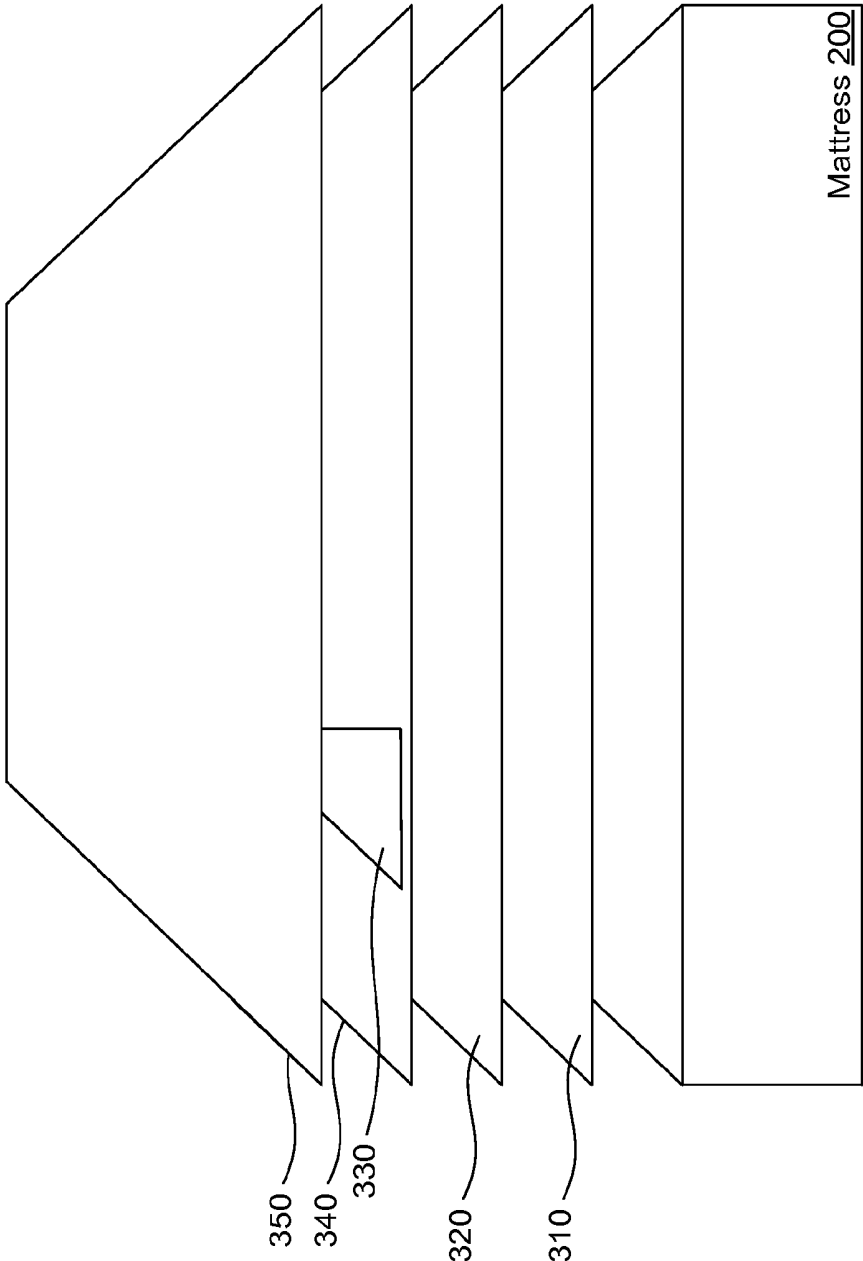
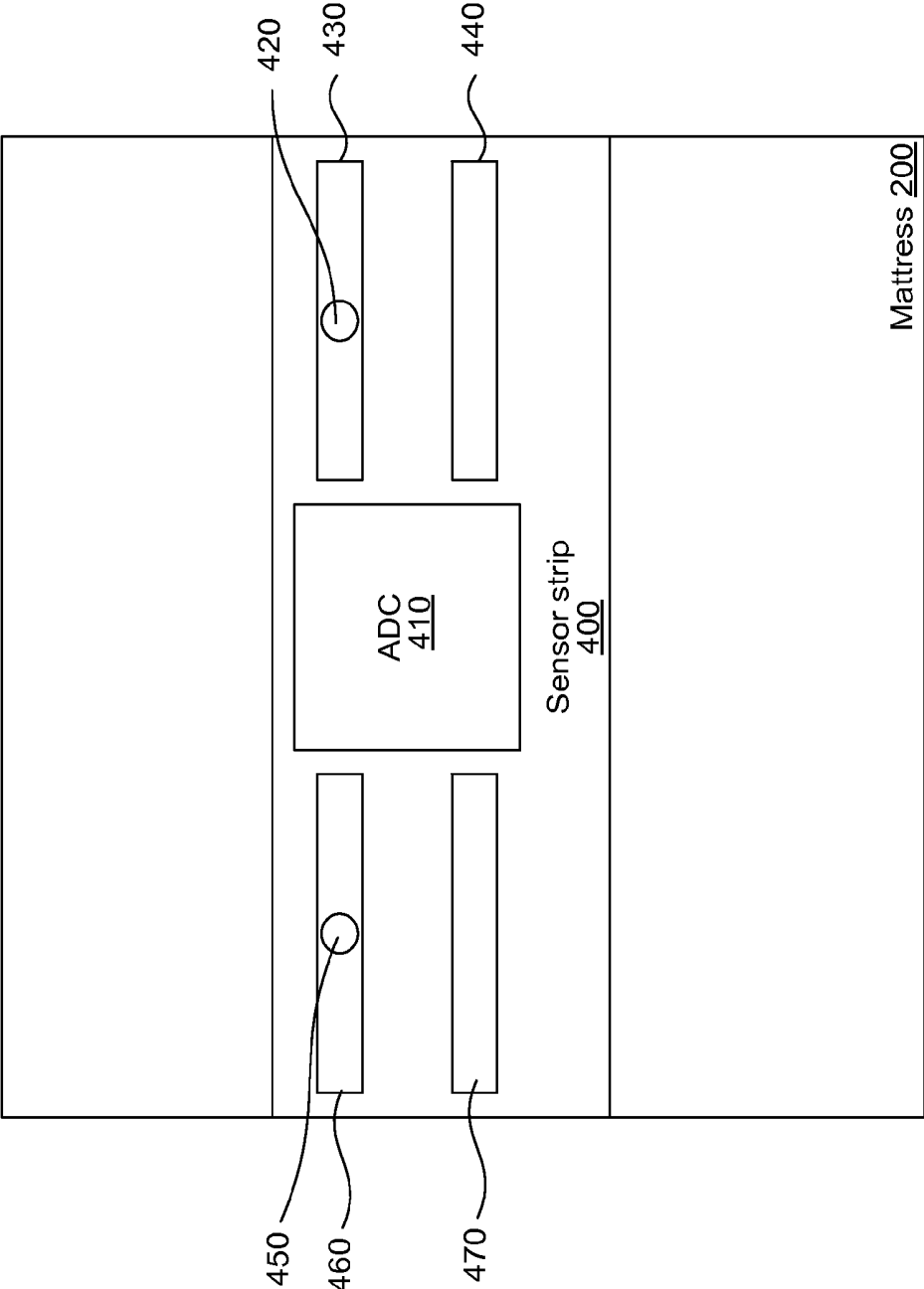

FIG. 2



**FIG. 3**



**FIG. 4**

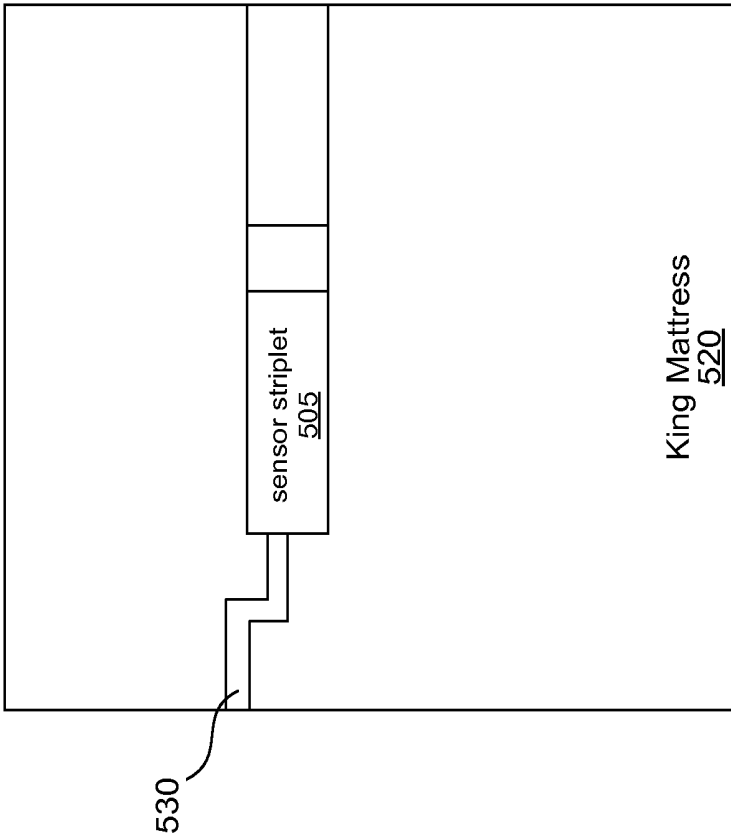

**FIG. 5B**

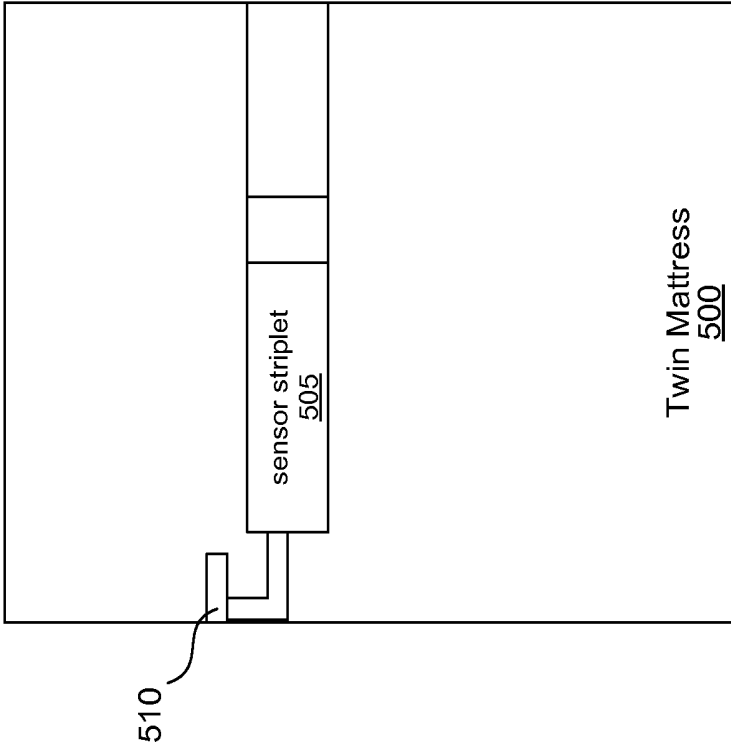

**FIG. 5A**

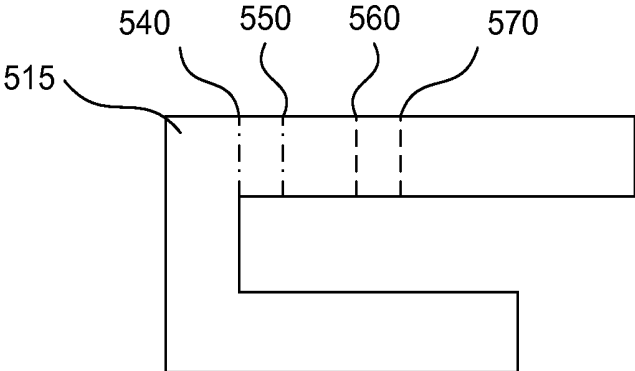

**FIG. 5C**

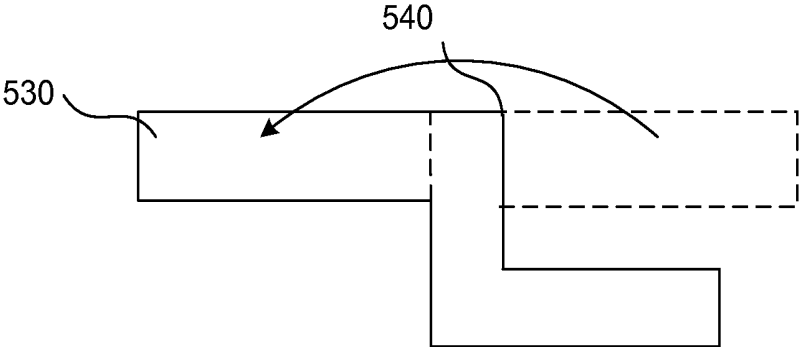

**FIG. 5D**

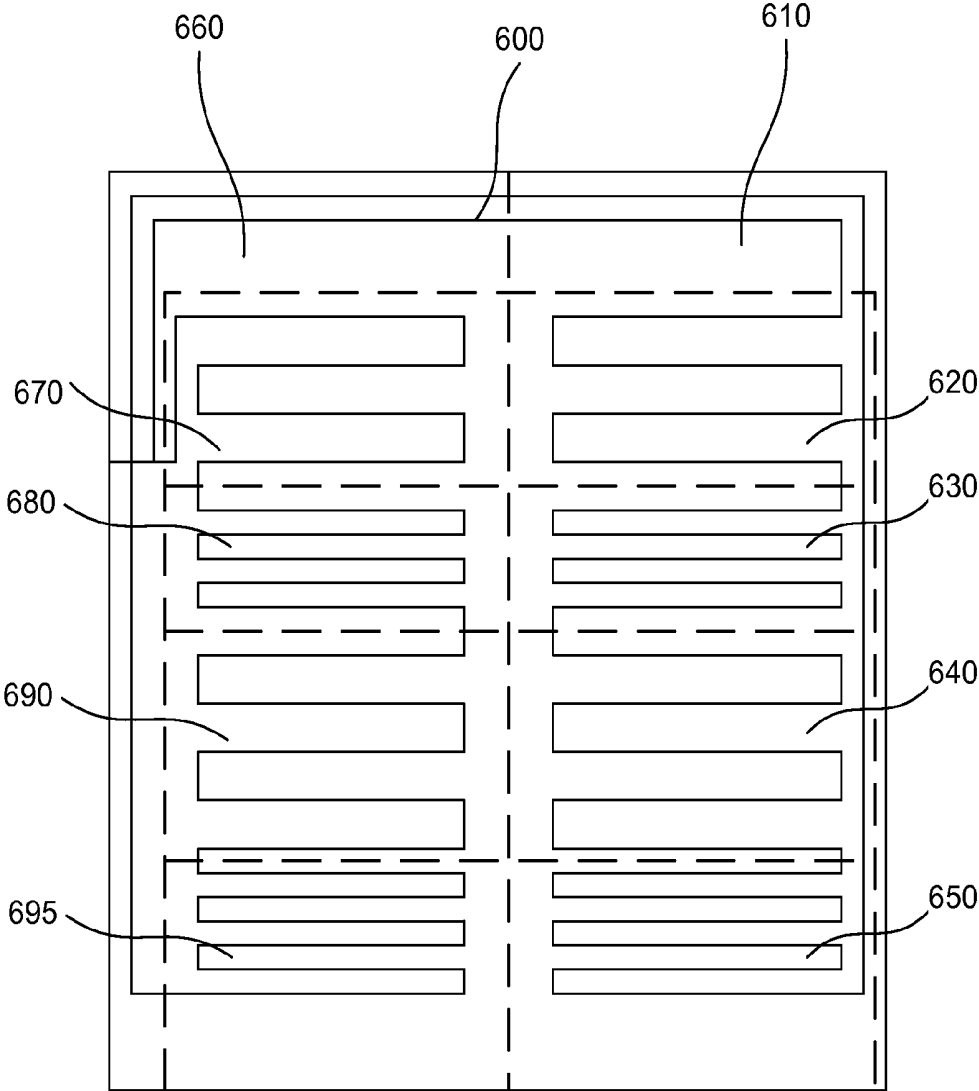

**FIG. 6A**

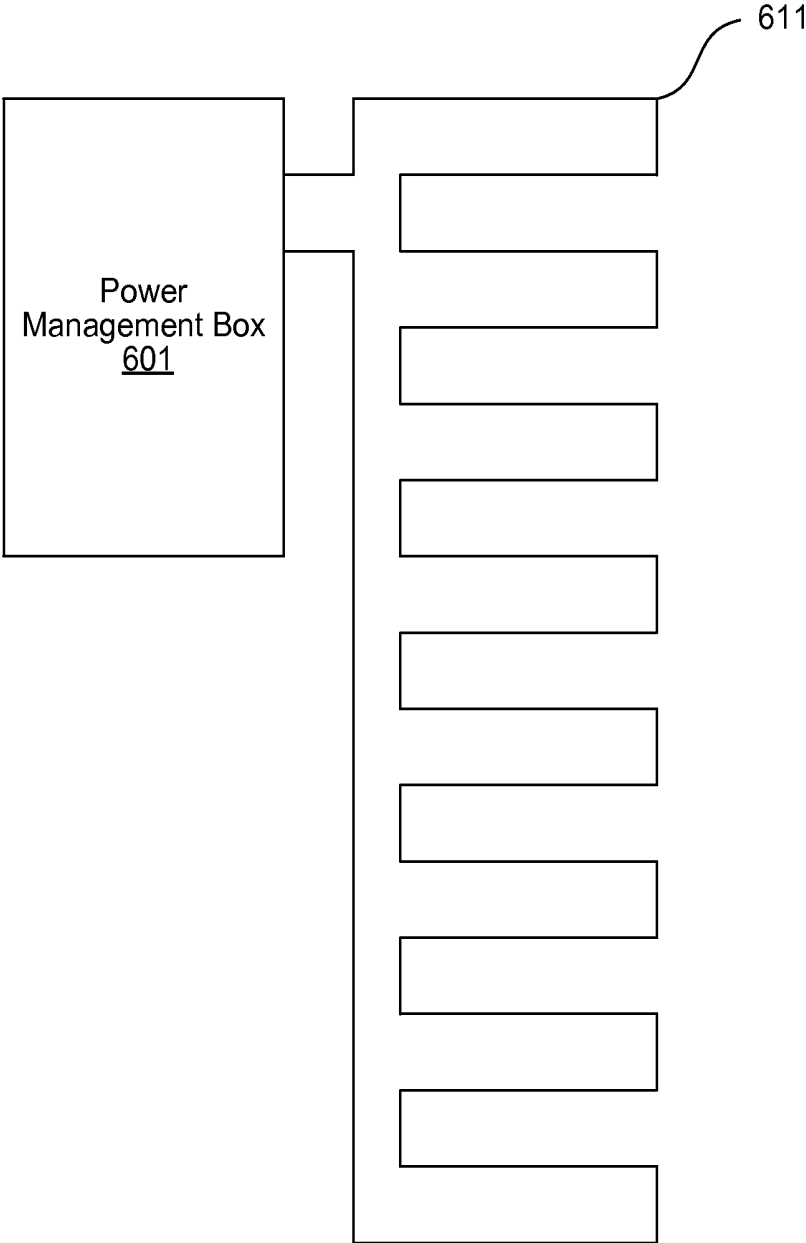

**FIG. 6B**

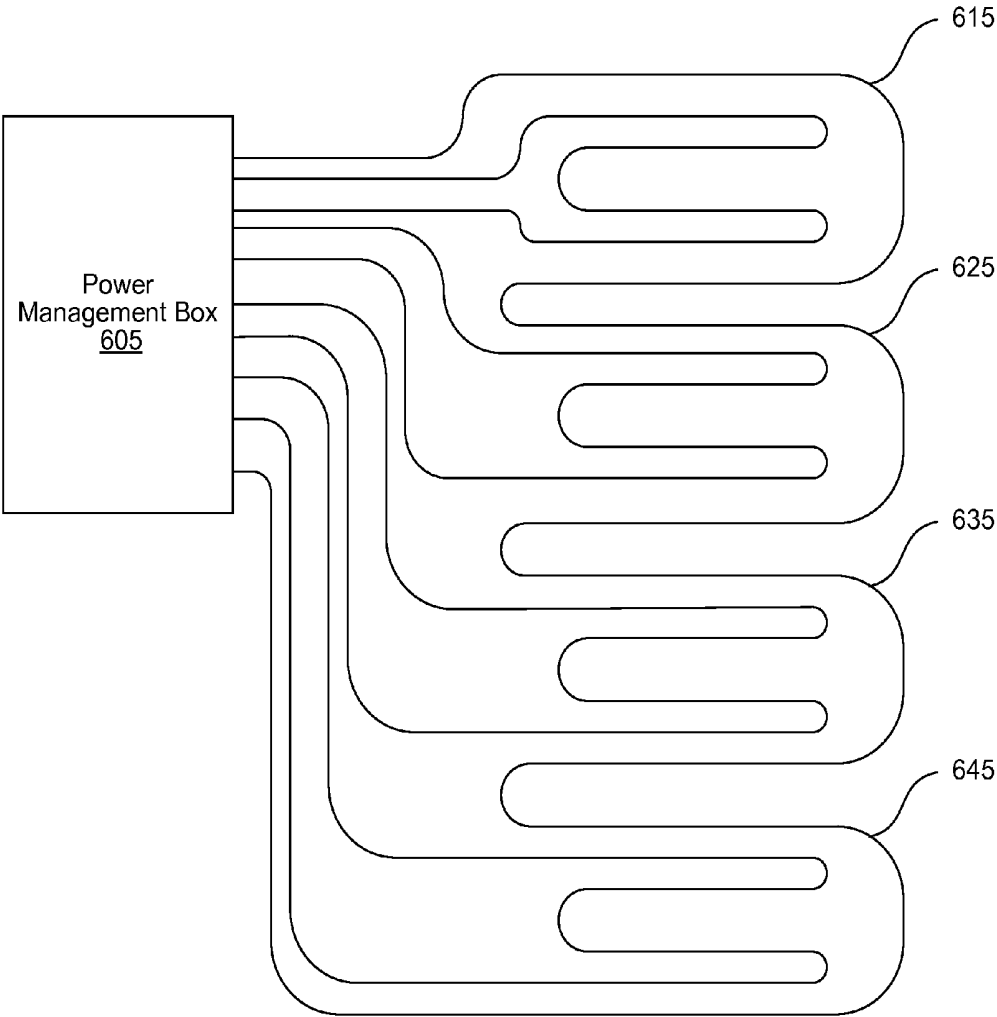

**FIG. 6C**

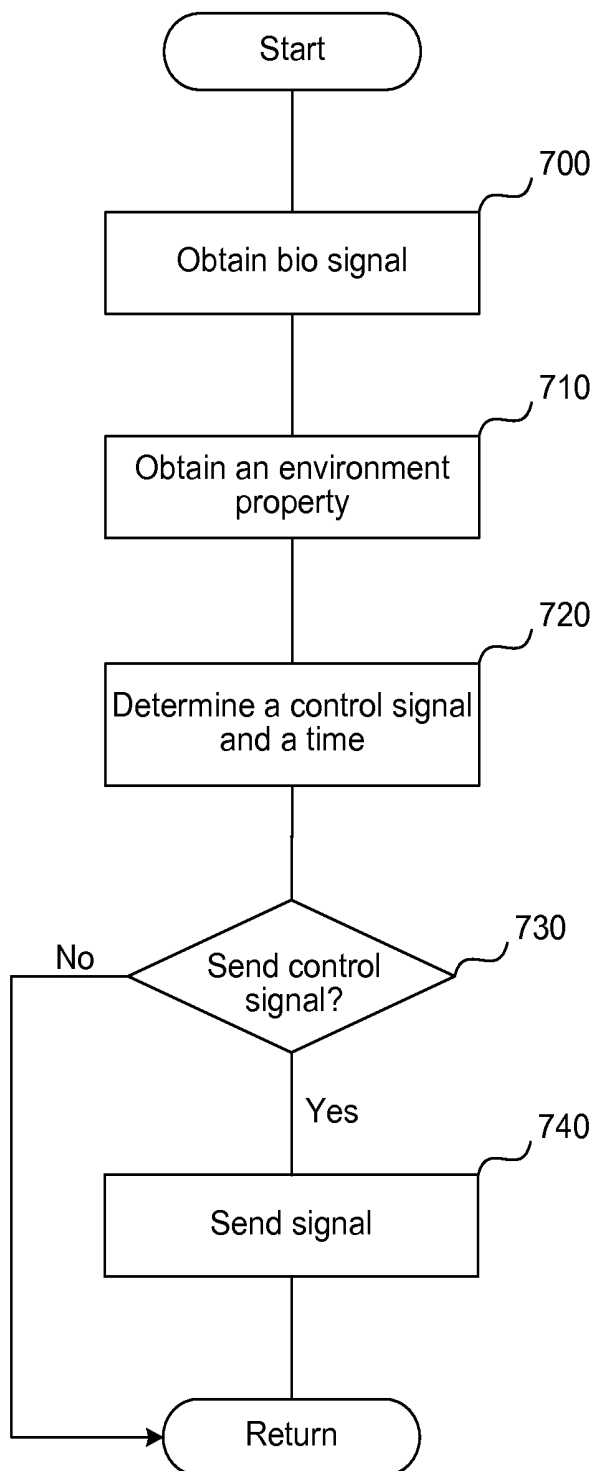

**FIG. 7**

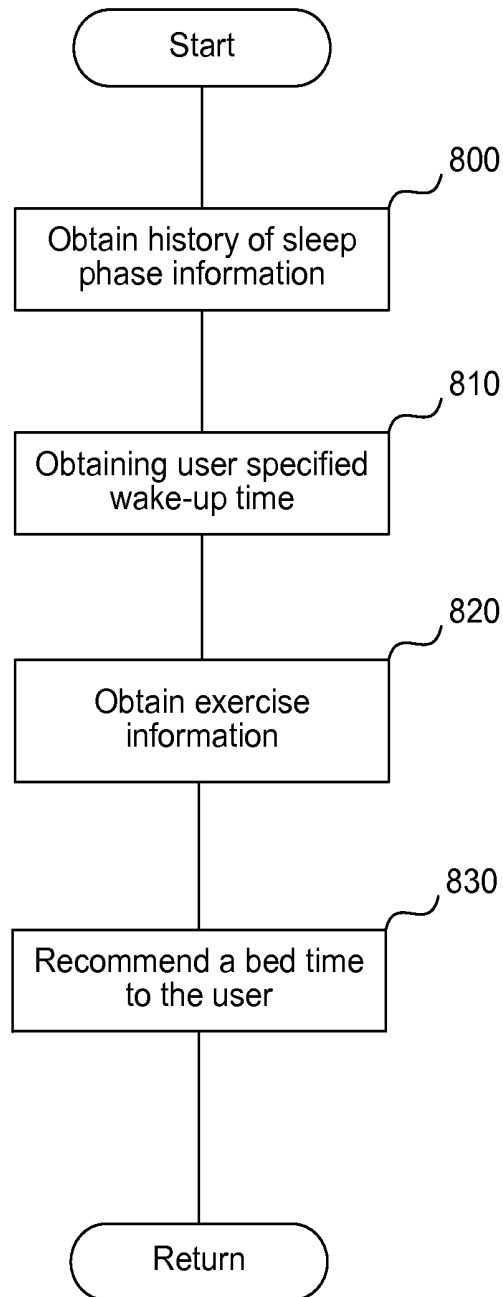

**FIG. 8**

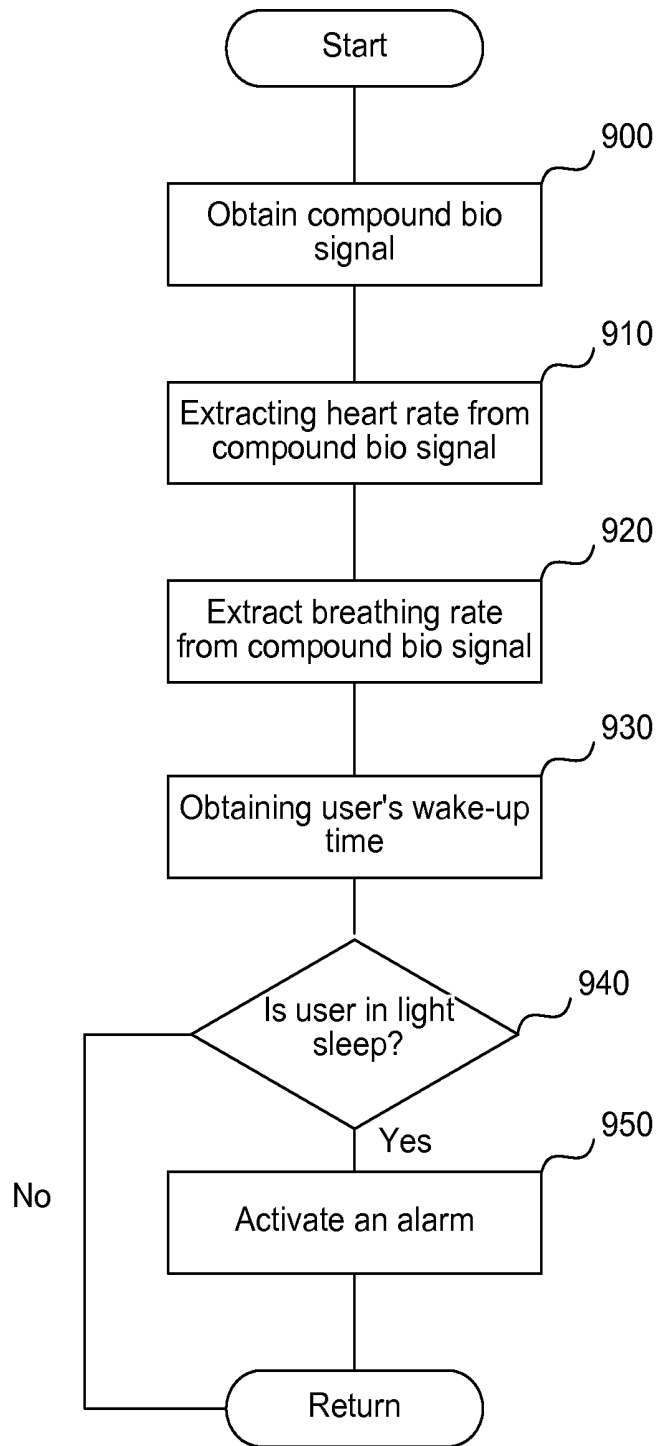

**FIG. 9**

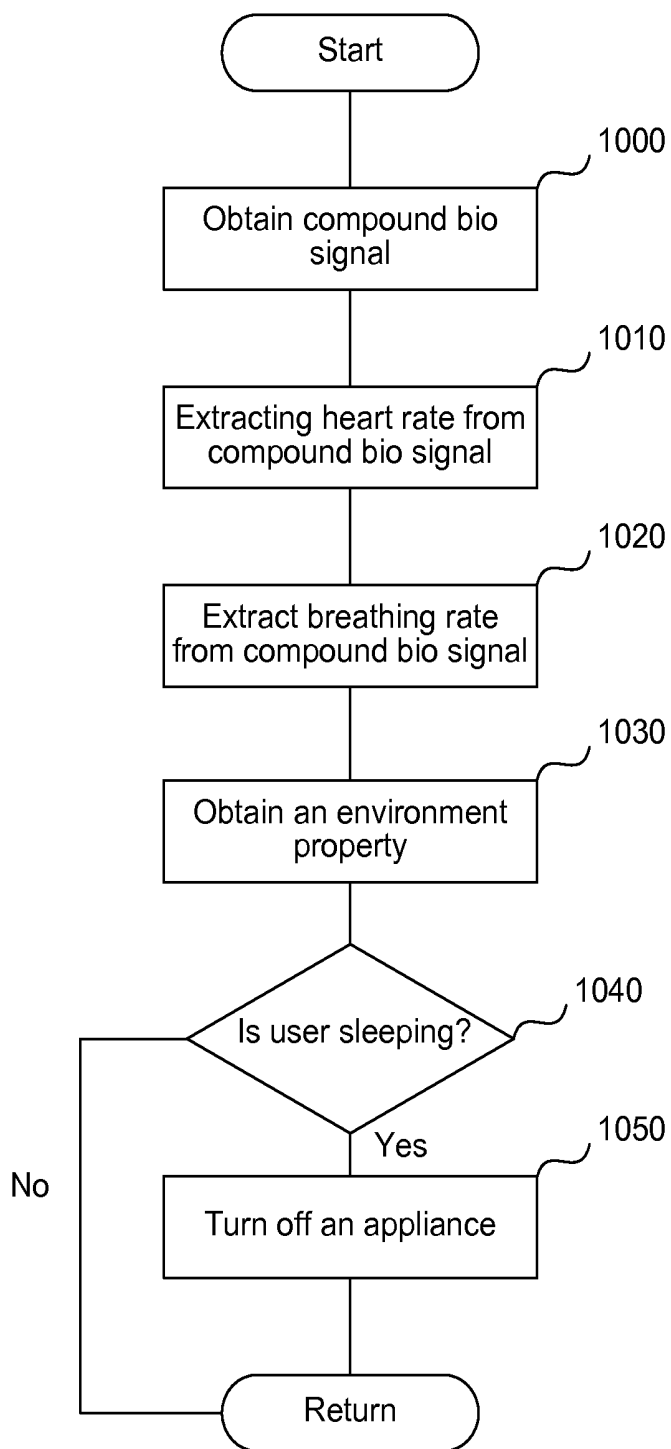

**FIG. 10**

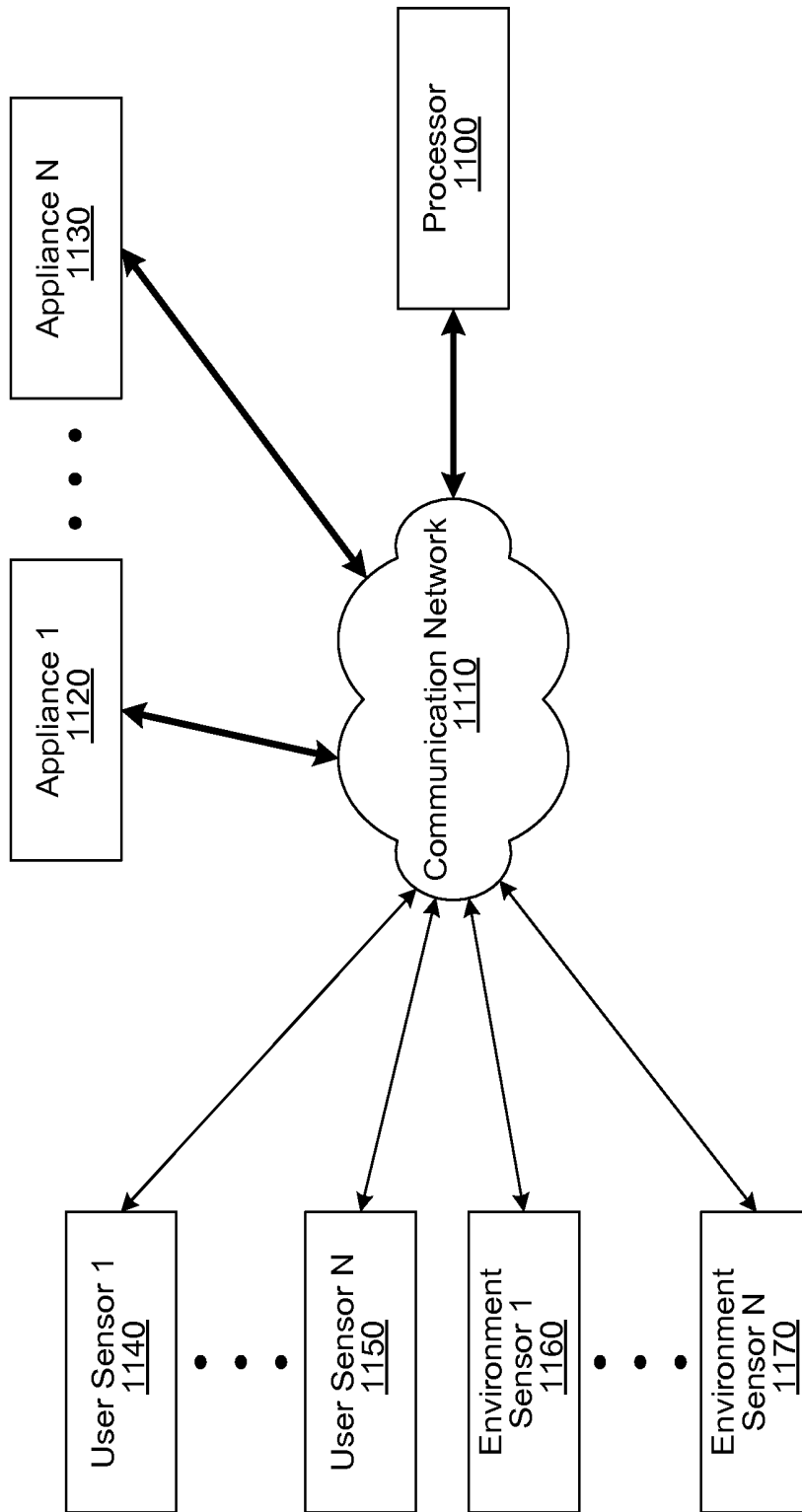

**FIG. 11**

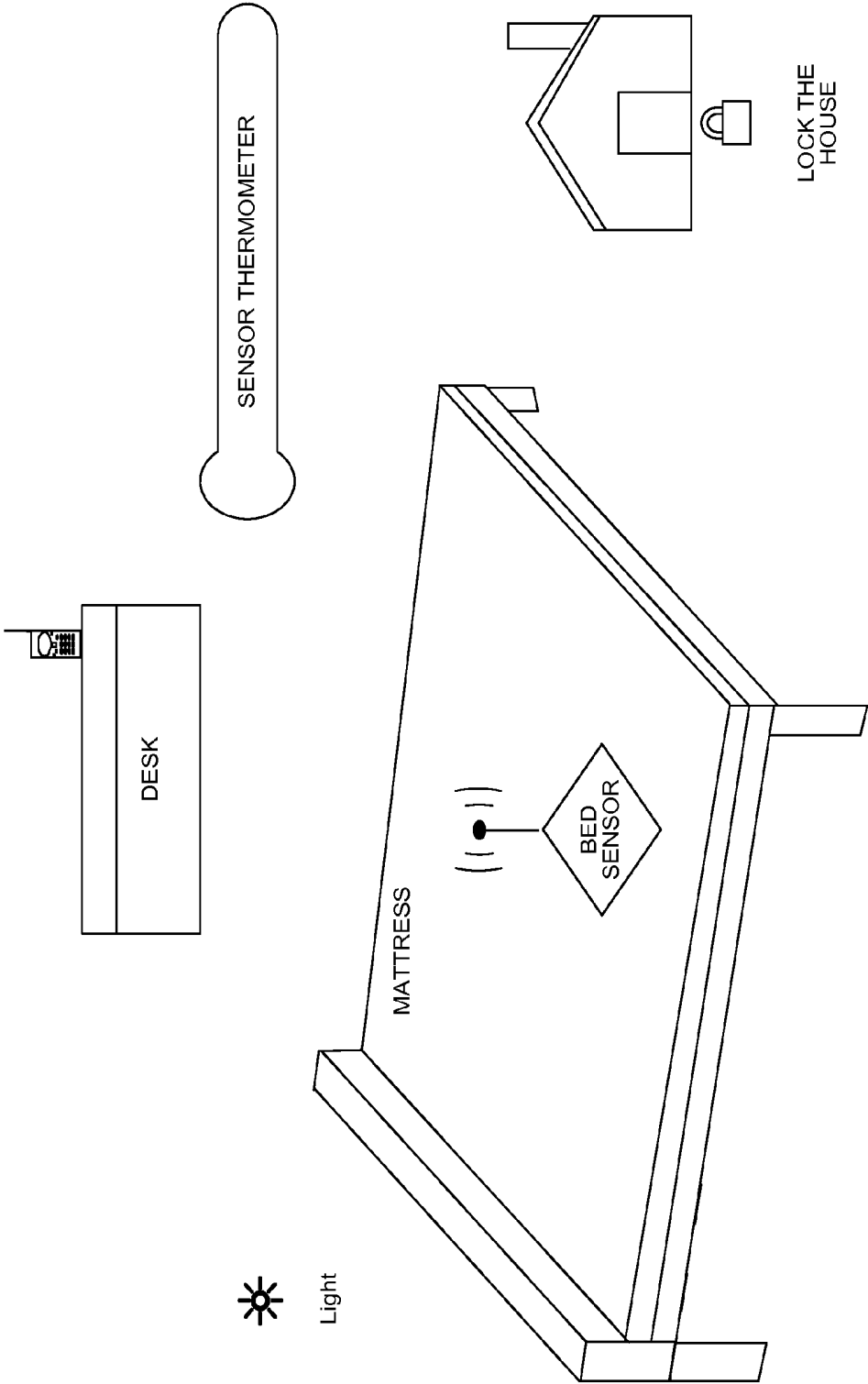

**FIG. 12**

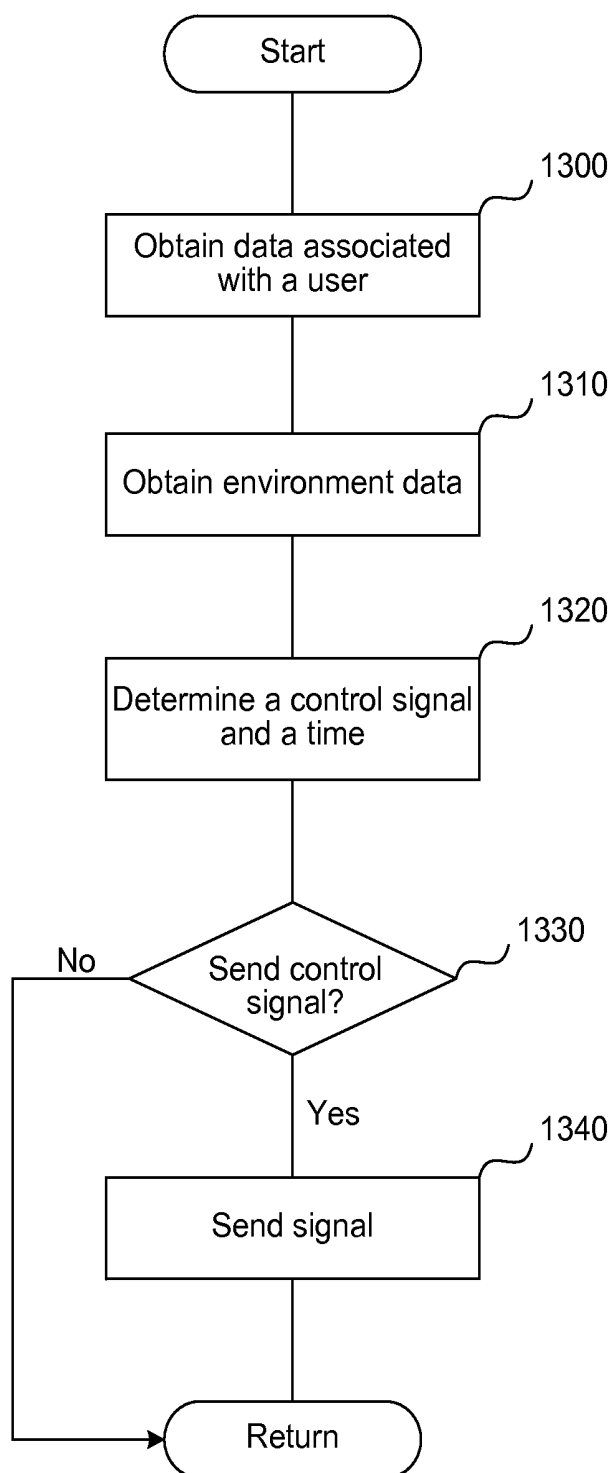

**FIG. 13**

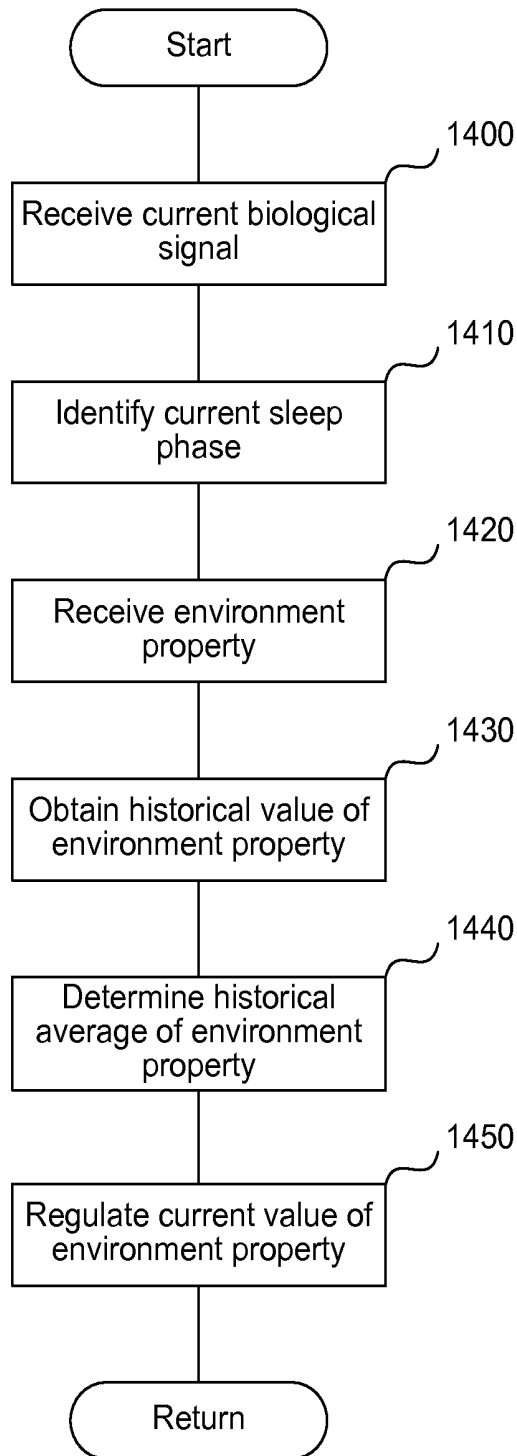

**FIG. 14**

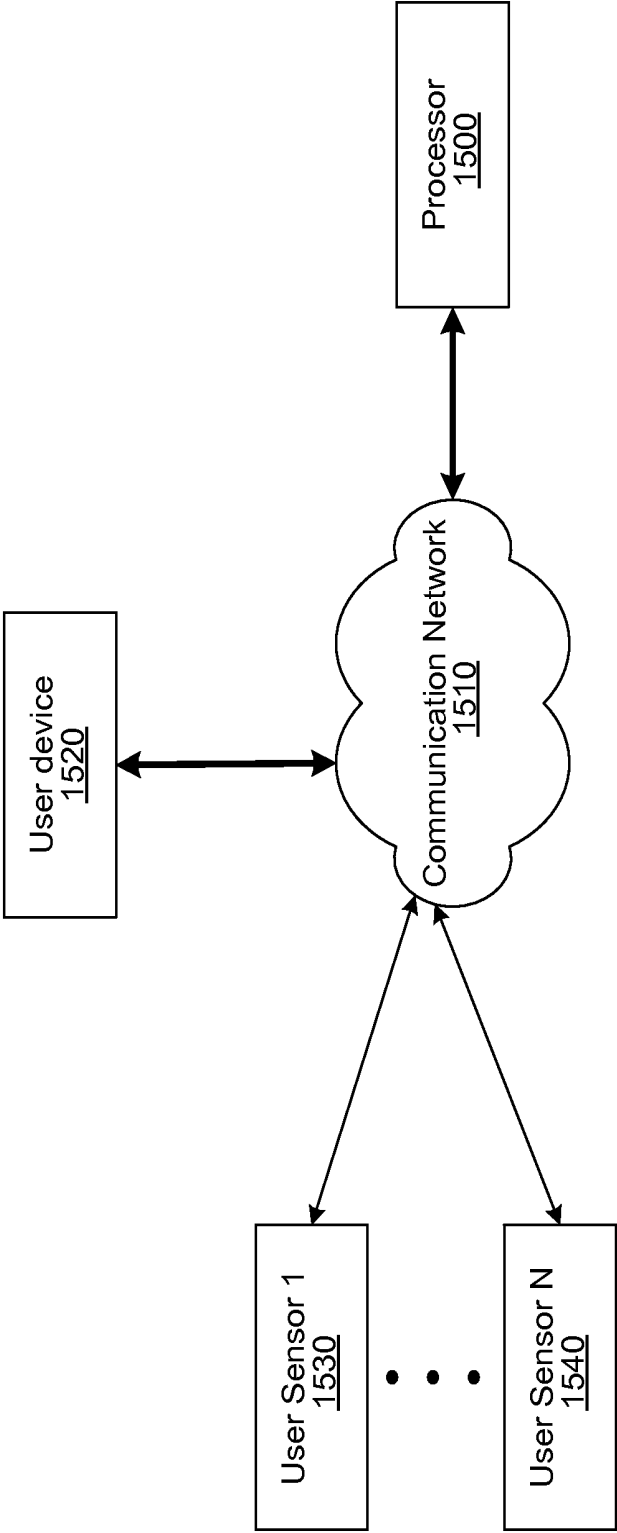

**FIG. 15**

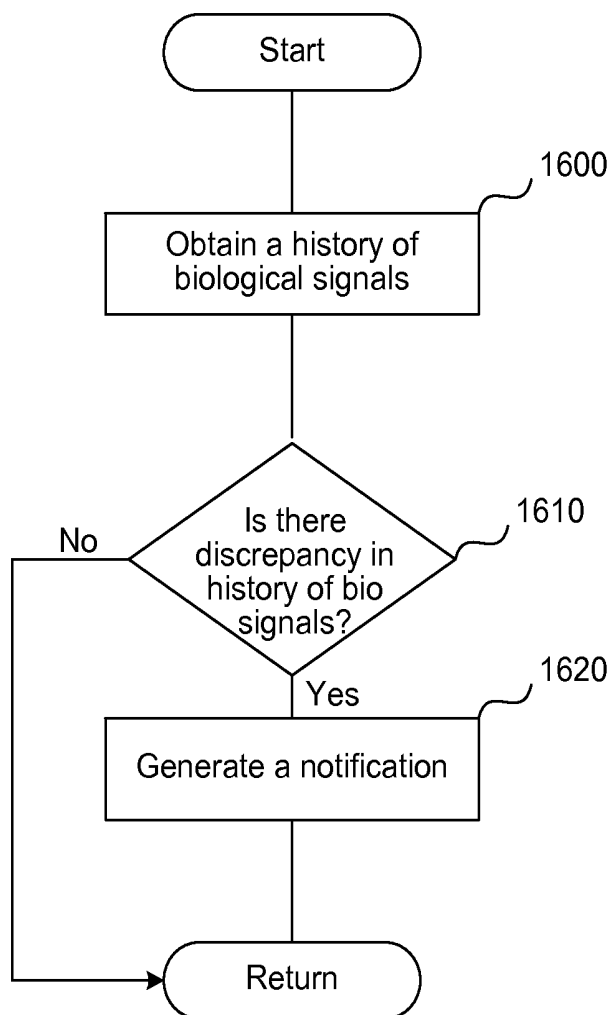

**FIG. 16**

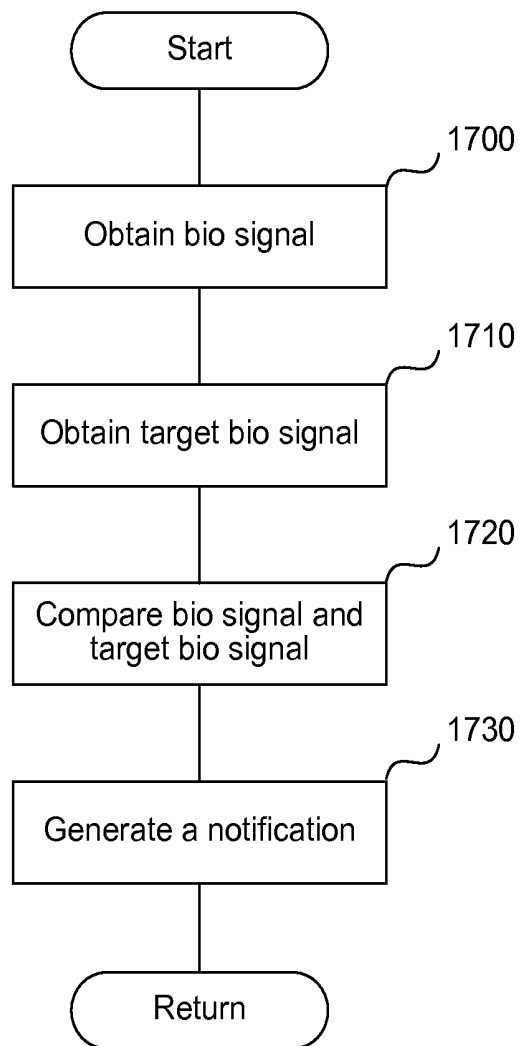

**FIG. 17**

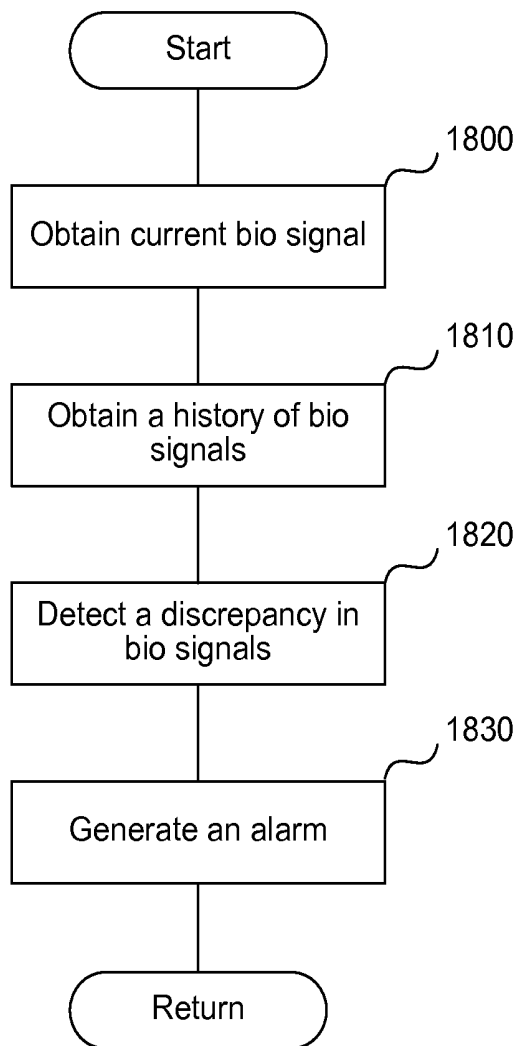

**FIG. 18**

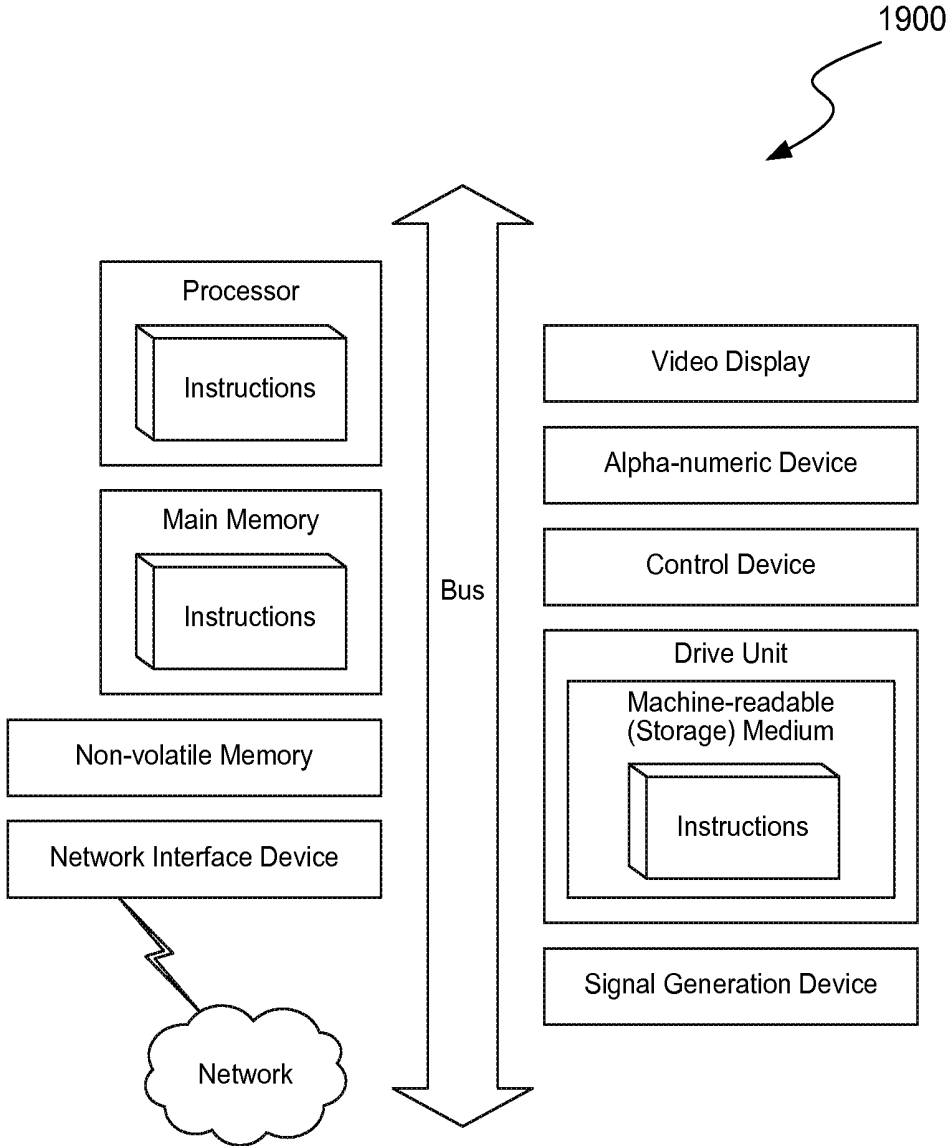

FIG. 19

## BED DEVICE SYSTEM AND METHODS

### CROSS-REFERENCE TO RELATED APPLICATIONS

[0001] This application claims priority to the following U.S. provisional patent applications: U.S. provisional patent application Ser. No. 62/008,480, filed Jun. 5, 2014; U.S. provisional patent application Ser. No. 62/024,945, filed Jul. 15, 2014; U.S. provisional patent application Ser. No. 62/159,177, filed May 8, 2015; and U.S. provisional patent application Ser. No. 62/161,142, filed May 13, 2015; which applications are incorporated herein in their entirety and by this reference thereto.

### TECHNICAL FIELD

[0002] Various embodiments relate generally to home automation devices, and human biological signal gathering and analysis.

### BACKGROUND

[0003] According to current scientific research into sleep, there are two major stages of sleep: rapid eye movement (“REM”) sleep, and non-REM sleep. First comes non-REM sleep, followed by a shorter period of REM sleep, and then the cycle starts over again.

[0004] There are three stages of non-REM sleep. Each stage can last from 5 to 15 minutes. A person goes through all three stages before reaching REM sleep.

[0005] In stage one, a person’s eyes are closed, but the person is easily woken up. This stage may last for 5 to 10 minutes.

[0006] In stage two, a person is in light sleep. A person’s heart rate slows and the person’s body temperature drops. The person’s body is getting ready for deep sleep.

[0007] Stage three is the deep sleep stage. A person is harder to rouse during this stage, and if the person was woken up, the person would feel disoriented for a few minutes. During the deep stages of non-REM sleep, the body repairs and regrows tissues, builds bone and muscle, and strengthens the immune system.

[0008] REM sleep happens 90 minutes after a person falls asleep. Dreams typically happen during REM sleep. The first period of REM typically lasts 10 minutes. Each of later REM stages gets longer, and the final one may last up to an hour. A person’s heart rate and breathing quickens. A person can have intense dreams during REM sleep, since the brain is more active. REM sleep affects learning of certain mental skills.

[0009] Even in today’s technological age, supporting healthy sleep is relegated to the technology of the past such as an electric blanket, a heated pad, or a bed warmer. The most advanced of these technologies, an electric blanket, is a blanket with an integrated electrical heating device which can be placed above the top bed sheet or below the bottom bed sheet. The electric blanket may be used to pre-heat the bed before use or to keep the occupant warm while in bed. However, turning on the electric blanket requires the user to remember to manually turn on the blanket, and then manually turn it on. Further, the electric blanket provides no additional functionality besides warming the bed.

### SUMMARY

[0010] Introduced are a bed device system and methods for: gathering human biological signals, such as heart rate, breath-

ing rate, or temperature; analyzing the gathered human biological signals; and controlling the bed device system based on the analysis.

[0011] In one embodiment of the invention, one or more user sensors, associated with a piece of furniture, such as a bed, measure the bio signals associated with a user, such as the heart rate associated with said user or breathing rate associated with said user. One or more environment sensors measure the environment property such as temperature, humidity, light, or sound. Based on the bio signals associated with said user and environment properties received, the system determines the time at which to send an instruction to an appliance to turn on or to turn off. In one embodiment, the appliance is a bed device, capable of heating or cooling the user’s bed. In another embodiment, the appliance is a thermostat, a light, a coffee machine, or a humidifier.

[0012] In another embodiment of the invention, based on the heart rate, temperature, and breathing rate, associated with a user, the system determines the sleep phase associated with said user. Based on the sleep phase and the user-specified wake-up time, the system determines a time to wake up the user, so that the user does not feel tired or disoriented when woken up.

### BRIEF DESCRIPTION OF THE DRAWINGS

[0013] These and other objects, features and characteristics of the present embodiments will become more apparent to those skilled in the art from a study of the following detailed description in conjunction with the appended claims and drawings, all of which form a part of this specification. While the accompanying drawings include illustrations of various embodiments, the drawings are not intended to limit the claimed subject matter.

[0014] FIG. 1 is a diagram of a bed device, according to one embodiment.

[0015] FIG. 2 illustrates an example of a bed device, according to one embodiment.

[0016] FIG. 3 illustrates an example of layers comprising a bed pad device, according to one embodiment.

[0017] FIG. 4 illustrates a user sensor placed on a sensor strip, according to one embodiment.

[0018] FIGS. 5A, 5B, 5C, and 5D show different configurations of a sensor strip, to fit different size mattresses, according to one embodiment.

[0019] FIG. 6A illustrates the division of the heating coil into zones and subzones, according to one embodiment.

[0020] FIGS. 6B and 6C illustrate the independent control of the different subzones, according to one embodiment.

[0021] FIG. 7 is a flowchart of the process for deciding when to heat or cool the bed device, according to one embodiment.

[0022] FIG. 8 is a flowchart of the process for recommending a bed time to a user, according to one embodiment.

[0023] FIG. 9 is a flowchart of the process for activating the user’s alarm, according to one embodiment.

[0024] FIG. 10 is a flowchart of the process for turning off an appliance, according to one embodiment.

[0025] FIG. 11 is a diagram of a system capable of automating the control of the home appliances, according to one embodiment.

[0026] FIG. 12 is an illustration of the system capable of controlling an appliance and a home, according to one embodiment.

[0027] FIG. 13 is a flowchart of the process for controlling an appliance, according to one embodiment.

[0028] FIG. 14 is a flowchart of the process for controlling an appliance, according to another embodiment.

[0029] FIG. 15 is a diagram of a system for monitoring biological signals associated with a user, and providing notifications or alarms, according to one embodiment.

[0030] FIG. 16 is a flowchart of a process for generating a notification based on a history of biological signals associated with a user, according to one embodiment.

[0031] FIG. 17 is a flowchart of a process for generating a comparison between a biological signal associated with a user and a target biological signal, according to one embodiment.

[0032] FIG. 18 is a flowchart of a process for detecting the onset of a disease, according to one embodiment.

[0033] FIG. 19 is a diagrammatic representation of a machine in the example form of a computer system within which a set of instructions, for causing the machine to perform any one or more of the methodologies or modules discussed herein, may be executed.

#### DETAILED DESCRIPTION

[0034] Examples of a method, apparatus, and computer program for automating the control of home appliances and improving the sleep environment are disclosed below. In the following description, for the purposes of explanation, numerous specific details are set forth in order to provide a thorough understanding of the embodiments of the invention. One skilled in the art will recognize that the embodiments of the invention may be practiced without these specific details or with an equivalent arrangement. In other instances, well-known structures and devices are shown in block diagram form in order to avoid unnecessarily obscuring the embodiments of the invention.

#### TERMINOLOGY

[0035] Brief definitions of terms, abbreviations, and phrases used throughout this application are given below.

[0036] In this specification, the term “biological signal” and “bio signal” are synonyms, and are used interchangeably.

[0037] Reference in this specification to “sleep phase” means light sleep, deep sleep, or REM sleep. Light sleep comprises stage one and stage two, non-REM sleep.

[0038] Reference in this specification to “one embodiment” or “an embodiment” means that a particular feature, structure, or characteristic described in connection with the embodiment is included in at least one embodiment of the disclosure. The appearances of the phrase “in one embodiment” in various places in the specification are not necessarily all referring to the same embodiment, nor are separate or alternative embodiments mutually exclusive of other embodiments. Moreover, various features are described that may be exhibited by some embodiments and not by others. Similarly, various requirements are described that may be requirements for some embodiments but not others.

[0039] Unless the context clearly requires otherwise, throughout the description and the claims, the words “comprise,” “comprising,” and the like are to be construed in an inclusive sense, as opposed to an exclusive or exhaustive sense; that is to say, in the sense of “including, but not limited to.” As used herein, the terms “connected,” “coupled,” or any variant thereof, means any connection or coupling, either

direct or indirect, between two or more elements. The coupling or connection between the elements can be physical, logical, or a combination thereof. For example, two devices may be coupled directly, or via one or more intermediary channels or devices. As another example, devices may be coupled in such a way that information can be passed there between, while not sharing any physical connection with one another. Additionally, the words “herein,” “above,” “below,” and words of similar import, when used in this application, shall refer to this application as a whole and not to any particular portions of this application. Where the context permits, words in the Detailed Description using the singular or plural number may also include the plural or singular number respectively. The word “or,” in reference to a list of two or more items, covers all of the following interpretations of the word: any of the items in the list, all of the items in the list, and any combination of the items in the list.

[0040] If the specification states a component or feature “may,” “can,” “could,” or “might” be included or have a characteristic, that particular component or feature is not required to be included or have the characteristic.

[0041] The term “module” refers broadly to software, hardware, or firmware components (or any combination thereof). Modules are typically functional components that can generate useful data or another output using specified input(s). A module may or may not be self-contained. An application program (also called an “application”) may include one or more modules, or a module may include one or more application programs.

[0042] The terminology used in the Detailed Description is intended to be interpreted in its broadest reasonable manner, even though it is being used in conjunction with certain examples. The terms used in this specification generally have their ordinary meanings in the art, within the context of the disclosure, and in the specific context where each term is used. For convenience, certain terms may be highlighted, for example using capitalization, italics, and/or quotation marks. The use of highlighting has no influence on the scope and meaning of a term; the scope and meaning of a term is the same, in the same context, whether or not it is highlighted. It will be appreciated that the same element can be described in more than one way.

[0043] Consequently, alternative language and synonyms may be used for any one or more of the terms discussed herein, but special significance is not to be placed upon whether or not a term is elaborated or discussed herein. A recital of one or more synonyms does not exclude the use of other synonyms. The use of examples anywhere in this specification, including examples of any terms discussed herein, is illustrative only and is not intended to further limit the scope and meaning of the disclosure or of any exemplified term. Likewise, the disclosure is not limited to various embodiments given in this specification.

#### Bed Device

[0044] FIG. 1 is a diagram of a bed device, according to one embodiment. Any number of user sensors 140, 150 monitor the bio signals associated with a user, such as the heart rate, the breathing rate, the temperature, motion, or presence, associated with said user. Any number of environment sensors 160, 170 monitor environment properties, such as temperature, sound, light, or humidity. The user sensors 140, 150 and the environment sensors 160, 170 communicate their measurements to the processor 100. The environment sensors

**160, 170**, measure the properties of the environment that the environment sensors **160, 170** are associated with. In one embodiment, the environment sensors **160, 170** are placed next to the bed. The processor **100** determines, based on the bio signals associated with said user, historical bio signals associated with said user, user-specified preferences, exercise data associated with said user, or the environment properties received, a control signal, and a time to send said control signal to a bed device **120**.

[0045] FIG. 2 illustrates an example of the bed device of FIG. 1, according to one embodiment. A user sensor **210**, associated with a mattress **200** of the bed device **120**, monitors bio signals associated with a user sleeping on the mattress **200**. The user sensor **210** can be built into the mattress **200**, or can be part of a bed pad device. Alternatively, the user sensor **210** can be a part of any other piece of furniture, such as a rocking chair, a couch, an armchair etc. The user sensor **210** comprises a temperature sensor, or a piezo sensor. The environment sensor **220** measures environment properties such as temperature, sound, light or humidity. According to one embodiment, the environment sensor **220** is associated with the environment surrounding the mattress **200**. The user sensor **210** and the environment sensor **220** communicate the measured environment properties to the processor **230**. In some embodiments, the processor **230** can be similar to the processor **100** of FIG. 1. A processor **230** can be connected to the user sensor **210**, or the environment sensor **220** by a computer bus, such as an I2C bus. Also, the processor **230** can be connected to the user sensor **210**, or the environment sensor **220** by a communication network. By way of example, the communication network connecting the processor **230** to the user sensor **210**, or the environment sensor **220** includes one or more networks such as a data network, a wireless network, a telephony network, or any combination thereof. The data network may be any local area network (LAN), metropolitan area network (MAN), wide area network (WAN), a public data network (e.g., the Internet), short range wireless network, or any other suitable packet-switched network, such as a commercially owned, proprietary packet-switched network, e.g., a proprietary cable or fiber-optic network, and the like, or any combination thereof. In addition, the wireless network may be, for example, a cellular network and may employ various technologies including enhanced data rates for global evolution (EDGE), general packet radio service (GPRS), global system for mobile communications (GSM), Internet protocol multimedia subsystem (IMS), universal mobile telecommunications system (UMTS), etc., as well as any other suitable wireless medium, e.g., worldwide interoperability for microwave access (WiMAX), Long Term Evolution (LTE) networks, code division multiple access (CDMA), wideband code division multiple access (WCDMA), wireless fidelity (WiFi), wireless LAN (WLAN), Bluetooth®, Internet Protocol (IP) data casting, satellite, mobile ad-hoc network (MANET), and the like, or any combination thereof.

[0046] The processor **230** is any type of microcontroller, or any processor in a mobile terminal, fixed terminal, or portable terminal including a mobile handset, station, unit, device, multimedia computer, multimedia tablet, Internet node, cloud computer, communicator, desktop computer, laptop computer, notebook computer, netbook computer, tablet computer, personal communication system (PCS) device, personal navigation device, personal digital assistants (PDAs), audio/video player, digital camera/camcorder, positioning

device, television receiver, radio broadcast receiver, electronic book device, game device, the accessories and peripherals of these devices, or any combination thereof.

[0047] FIG. 3 illustrates an example of layers comprising the bed pad device of FIG. 1, according to one embodiment. In some embodiments, the bed pad device **120** is a pad that can be placed on top of the mattress. Bed pad device **120** comprises a number of layers. A top layer **350** comprises fabric. A layer **340** comprises batting, and a sensor strip **330**. A layer **320** comprises coils for cooling or heating the bed device. A layer **310** comprises waterproof material.

[0048] FIG. 4 illustrates a user sensor **420, 440, 450, 470** placed on a sensor strip **400**, according to one embodiment. In some embodiments, the user sensors **420, 440, 450, 470** can be similar to or part of the user sensor **210** of FIG. 2. Sensors **470** and **440** comprise a piezo sensor, which can measure a bio signal associated with a user, such as the heart rate and the breathing rate. Sensors **450** and **420** comprise a temperature sensor. According to one embodiment, sensors **450**, and **470** measure the bio signals associated with one user, while sensors **420, 440** measure the bio signals associated with another user. Analog-to-digital converter **410** converts the analog sensor signals into digital signals to be communicated to a processor. Computer bus **430** and **460**, such as the I2C bus, communicates the digitized bio signals to a processor.

[0049] FIGS. 5A and 5B show different configurations of the sensor strip, to fit different size mattresses, according to one embodiment. FIGS. 5C and 5D show how such different configurations of the sensor strip can be achieved. Specifically, sensor strip **400** comprises a computer bus **510, 530**, and a sensor triplet **505**. The computer bus **510, 530** can be bent at predetermined locations **540, 550, 560, 570**. Bending the computer bus **515** at location **540** produces the maximum total length of the computer bus **530**. Computer bus **530** combined with a sensor triplet **505**, fits a king size mattress **520**. Bending the computer bus **515** at location **570** produces the smallest total length of the computer bus, **510**. Computer bus **510** combined with a sensor triplet **505**, fits a twin size mattress **500**. Bending the computer bus **515** at location **560**, enables the sensor strip **400** to fit a full-size bed. Bending the computer bus **515** at location **550** enables the sensor strip **400** to fit a queen-size bed. In some embodiments, twin mattress **500**, or king mattress **520** can be similar to the mattress **200** of FIG. 2.

[0050] FIG. 6A illustrates the division of the heating coil **600** into zones and subzones, according to one embodiment. Specifically, the heating coil **600** is divided into two zones **660** and **610**, each corresponding to one user of the bed. Each zone **660** and **610** can be heated or cooled independently of the other zone in response to the user's needs. To achieve independent heating of the two zones **660** and **610**, the power supply associated with the heating coil **600** is divided into two zones, each power supply zone corresponding to a single user zone **660, 610**. Further, each zone **660** and **610** is further subdivided into subzones. Zone **660** is divided into subzones **670, 680, 690**, and **695**. Zone **610** is divided into subzones **620, 630, 640**, and **650**. The distribution of coils in each subzone is configured so that the subzone is uniformly heated. However, the subzones may differ among themselves in the density of coils. For example, the data associated with said user subzone **670** has lower density of coils than subzone **680**. This will result in subzone **670** having lower temperature than subzone **680**, when the coils are heated. Similarly, when the coils are used for cooling, subzones **670** will have higher

temperature than subzone 680. According to one embodiment, subzones 680 and 630 with highest coil density correspond to the user's lower back; and subzones 695 and 650 with highest coil density correspond to user's feet. According to one embodiment, even if the users switch sides of the bed, the system will correctly identify which user is sleeping in which zone by identifying the user based on any of the following signals alone, or in combination: heart rate, breathing rate, body motion, or body temperature associated with said user.

[0051] In another embodiment, the power supply associated with the heating coil 600 is divided into a plurality of zones, each power supply zone corresponding to a subzone 620, 630, 640, 650, 670, 680, 690, 695. The user can control the temperature of each subzone 620, 630, 640, 650, 670, 680, 690, 695 independently. Further, each user can independently specify the temperature preferences for each of the subzones. Even if the users switch sides of the bed, the system will correctly identify the user, and the preferences associated with the user by identifying the user based on any of the following signals alone, or in combination: heart rate, breathing rate, body motion, or body temperature associated with said user.

[0052] FIGS. 6B and 6C illustrate the independent control of the different subzones in each zone 610, 660, according to one embodiment. Set of uniform coils 611, connected to power management box 601, uniformly heats or cools the bed. Another set of coils, targeting specific areas of the body such as the neck, the back, the legs, or the feet, is layered on top of the uniform coils 611. Subzone 615 heats or cools the neck. Subzone 625 heats or cools the back. Subzone 635 heats or cools the legs, and subzone 645 heats or cools the feet. Power is distributed to the coils via duty cycling of the power supply 605. Contiguous sets of coils can be heated or cooled at different levels by assigning the power supply duty cycle to each set of coils. The user can control the temperature of each subzone independently.

[0053] FIG. 7 is a flowchart of the process for deciding when to heat or cool the bed device, according to one embodiment. At block 700, the process obtains a biological signal associated with a user, such as presence in bed, motion, breathing rate, heart rate, or a temperature. The process obtains said biological signal from a sensor associated with a user. Further, at block 710, the process obtains environment property, such as the amount of ambient light and the bed temperature. The process obtains environment property from and environment sensor associated with the bed device. If the user is in bed, the bed temperature is low, and the ambient light is low, the process sends a control signal to the bed device. The control signal comprises an instruction to heat the bed device to the average nightly temperature associated with said user. According to another embodiment, the control signal comprises an instruction to heat the bed device to a user-specified temperature. Similarly, if the user is in bed, the bed temperature is high, and the ambient light is low, the process sends a control signal to the bed device to cool the bed device to the average nightly temperature associated with said user. According to another embodiment, the control signal comprises an instruction to cool the bed device to a user-specified temperature.

[0054] In another embodiment, in addition to obtaining the biological signal associated with said user, and the environment property, the process obtains a history of biological signals associated with said user. The history of biological

signals can be stored in a database associated with the bed device, or in a database associated with a user. The history of biological signals comprises the average bedtime the user went to sleep for each day of the week; that is, the history of biological signals comprises the average bedtime associated with said user on Monday, the average bedtime associated with said user on Tuesday, etc. For a given day of the week, the process determines the average bedtime associated with said user for that day of the week, and sends the control signal to the bed device, allowing enough time for the bed to reach the desired temperature, before the average bedtime associated with said user. The control signal comprises an instruction to heat, or cool the bed to a desired temperature. The desired temperature may be automatically determined, such as by averaging the historical nightly temperature associated with a user, or the desired temperature may be specified by the user.

#### Bio Signal Processing

[0055] The technology disclosed here categorizes the sleep phase associated with a user as light sleep, deep sleep, or REM sleep. Light sleep comprises stage one and stage two sleep. The technology performs the categorization based on the breathing rate associated with said user, heart rate associated with said user, motion associated with said user, and body temperature associated with said user. Generally, when said user is awake the breathing is erratic. When the user is sleeping, the breathing becomes regular. The transition between being awake and sleeping is quick, and lasts less than 1 minute.

[0056] FIG. 8 is a flowchart of the process for recommending a bed time to the user, according to one embodiment. At block 800, the process obtains a history of sleep phase information associated with said user. The history of sleep phase information comprises an amount of time the user spent in each of the sleep phases, light sleep, deep sleep, or REM sleep. The history of sleep phase information can be stored in a database associated with the user. Based on this information, the process determines how much light sleep, deep sleep, and REM sleep, the user needs on average every day. In another embodiment, the history of sleep phase information comprises the average bedtime associated with said user for each day of the week (e.g. the average bedtime associated with said user on Monday, the average bedtime associated with said user on Tuesday, etc.). At block 810, the process obtains user-specified wake-up time, such as the alarm setting associated with said user. At block 820, the process obtains exercise information associated with said user, such as the distance the user ran that day, the amount of time the user exercised in the gym, or the amount of calories the user burned that day. According to one embodiment, the process obtains said exercise information from a user phone, a wearable device, a fitbit bracelet, or a database storing said exercise information. Based on all this information, at block 830, the process recommends a bedtime to the user. For example, if the user has not been getting enough deep and REM sleep in the last few days, the process recommends an earlier bedtime to the user. Also, if the user has exercised more than the average daily exercise, the process recommends an earlier bedtime to the user.

[0057] FIG. 9 is a flowchart of the process for activating a user's alarm, according to one embodiment. At block 900, the process obtains the compound bio signal associated with said user. The compound bio signal associated with said user

comprises the heart rate associated with said user, and the breathing rate associated with said user. According to one embodiment, the process obtains the compound bio signal from a sensor associated with said user. At block **910**, the process extracts the heart rate signal from the compound bio signal. For example, the process extracts the heart rate signal associated with said user by performing low-pass filtering on the compound bio signal. Also, at block **920**, the process extracts the breathing rate signal from the compound bio signal. For example, the process extracts the breathing rate by performing bandpass filtering on the compound bio signal. The breathing rate signal includes breath duration, pauses between breaths, as well as breaths per minute. At block **930**, the process obtains user's wake-up time, such as the alarm setting associated with said user. Based on the heart rate signal and the breathing rate signal, the process determines the sleep phase associated with said user, and if the user is in light sleep, and current time is at most one hour before the alarm time, at block **940**, the process activates an alarm. Waking up the user during the deep sleep or REM sleep is detrimental to the user's health because the user will feel disoriented, groggy, and will suffer from impaired memory. Consequently, at block **950**, the process activates an alarm, when the user is in light sleep and when the current time is at most one hour before the user specified wake-up time.

**[0058]** FIG. 10 is a flowchart of the process for turning off an appliance, according to one embodiment. At block **1000**, the process obtains the compound bio signal associated with said user. The compound bio signal comprises the heart rate associated with said user, and the breathing rate associated with said user. According to one embodiment, the process obtains the compound bio signal from a sensor associated with said user. At block **1010**, the process extracts the heart rate signal from the compound bio signal by, for example, performing low-pass filtering on the compound bio signal. Also, at block **1020**, the process extracts the breathing rate signal from the compound bio signal by, for example, performing bandpass filtering on the compound bio signal. At block **1030**, the process obtains an environment property, comprising temperature, humidity, light, sound from an environment sensor associated with said user sensor. Based on the environment property and the sleep state associated with said user, at block **1040**, the process determines whether the user is sleeping. If the user is sleeping, the process, at block **1050**, turns an appliance off. For example, if the user is asleep and the environment temperature is above the average nightly temperature, the process turns off the thermostat. Further, if the user is asleep and the lights are on, the process turns off the lights. Similarly, if the user is asleep and the TV is on, the process turns off the TV.

#### Smart Home

**[0059]** FIG. 11 is a diagram of a system capable of automating the control of the home appliances, according to one embodiment. Any number of user sensors **1140**, **1150** monitor biological signals associated with said user, such as temperature, motion, presence, heart rate, or breathing rate. Any number of environment sensors **1160**, **1170** monitor environment properties, such as temperature, sound, light, or humidity. According to one embodiment, the environment sensors **1160**, **1170** are placed next to a bed. The user sensors **1140**, **1150** and the environment sensors **1160**, **1170** communicate their measurements to the processor **1100**. The processor **1100** determines, based on the current biological signals asso-

ciated with said user, historical biological signals associated with said user, user-specified preferences, exercise data associated with said user, and the environment properties received, a control signal, and a time to send said control signal to an appliance **1120**, **1130**.

**[0060]** The processor **1100** is any type of microcontroller, or any processor in a mobile terminal, fixed terminal, or portable terminal including a mobile handset, station, unit, device, multimedia computer, multimedia tablet, Internet node, cloud computer, communicator, desktop computer, laptop computer, notebook computer, netbook computer, tablet computer, personal communication system (PCS) device, personal navigation device, personal digital assistants (PDAs), audio/video player, digital camera/camcorder, positioning device, television receiver, radio broadcast receiver, electronic book device, game device, the accessories and peripherals of these devices, or any combination thereof.

**[0061]** The processor **1100** can be connected to the user sensor **1140**, **1150**, or the environment sensor **1160**, **1170** by a computer bus, such as an I2C bus. Also, the processor **1100** can be connected to the user sensor **1140**, **1150**, or environment sensor **1160**, **1170** by a communication network **1110**. By way of example, the communication network **1110** connecting the processor **1100** to the user sensor **1140**, **1150**, or the environment sensor **1160**, **1170** includes one or more networks such as a data network, a wireless network, a telephony network, or any combination thereof. The data network may be any local area network (LAN), metropolitan area network (MAN), wide area network (WAN), a public data network (e.g., the Internet), short range wireless network, or any other suitable packet-switched network, such as a commercially owned, proprietary packet-switched network, e.g., a proprietary cable or fiber-optic network, and the like, or any combination thereof. In addition, the wireless network may be, for example, a cellular network and may employ various technologies including enhanced data rates for global evolution (EDGE), general packet radio service (GPRS), global system for mobile communications (GSM), Internet protocol multimedia subsystem (IMS), universal mobile telecommunications system (UMTS), etc., as well as any other suitable wireless medium, e.g., worldwide interoperability for microwave access (WiMAX), Long Term Evolution (LTE) networks, code division multiple access (CDMA), wideband code division multiple access (WCDMA), wireless fidelity (WiFi), wireless LAN (WLAN), Bluetooth®, Internet Protocol (IP) data casting, satellite, mobile ad-hoc network (MANET), and the like, or any combination thereof.

**[0062]** FIG. 12 is an illustration of the system capable of controlling an appliance and a home, according to one embodiment. The appliances, that the system disclosed here can control, comprise an alarm, a coffee machine, a lock, a thermostat, a bed device, a humidifier, or a light. For example, the system detects that the user has fallen asleep, the system sends a control signal to the lights to turn off, to the locks to engage, and to the thermostat to lower the temperature. According to another example, if the system detects that the user has woken up and it is morning, the system sends a control signal to the coffee machine to start making coffee.

**[0063]** FIG. 13 is a flowchart of the process for controlling an appliance, according to one embodiment. In one embodiment, at block **1300**, the process obtains history of biological signals, such as at what time does the user go to bed on a particular day of the week (e.g. the average bedtime associ-

ated with said user on Monday, the average bedtime associated with said user on Tuesday etc.). The history of biological signals can be stored in a database associated with the user, or in a database associated with the bed device. In another embodiment, at block **1300**, the process also obtains user specified preferences, such as the preferred bed temperature associated with said user. Based on the history of biological signals and user-specified preferences, the process, at block **1320**, determines a control signal, and a time to send said control signal to an appliance. At block **1330**, the process determines whether to send a control signal to an appliance. For example, if the current time is within half an hour of average bedtime associated with said user on that particular day of the week, the process, at block **1340**, sends a control signal to an appliance. For example, the control signal comprises an instruction to turn on the bed device, and the user specified bed temperature. Alternatively, the bed temperature is determined automatically, such as by calculating the average nightly bed temperature associated with a user.

**[0064]** According to another embodiment, at block **1300**, the process obtains a current biological signal associated with a user from a sensor associated with said user. At block **1310**, the process also obtains environment data, such as the ambient light, from an environment sensor associated with a bed device. Based on the current biological signal, the process identifies whether the user is asleep. If the user is asleep and the lights are on, the process sends an instruction to turn off the lights. In another embodiment, if the user is asleep, the lights are off, and the ambient light is high, the process sends an instruction to the blinds to shut. In another embodiment, if the user is asleep, the process sends an instruction to the locks to engage.

**[0065]** In another embodiment, the process, at block **1300**, obtains history of biological signals, such as at what time the user goes to bed on a particular day of the week (e.g. the average bedtime associated with said user on Monday, the average bedtime associated with said user on Tuesday etc.). The history of biological signals can be stored in a database associated with the bed device, or in a database associated with a user. Alternatively, the user may specify a bedtime for the user for each day of the week. Further, the process obtains the exercise data associated with said user, such as the number of hours the user spent exercising, or the heart rate associated with said user during exercising. According to one embodiment, the process obtains the exercise data from a user phone, a wearable device, fitbit bracelet, or a database associated with said user. Based on the average bedtime for that day of the week, and the exercise data during the day, the process, at block **1320**, determines the expected bedtime associated with said user that night. The process then sends an instruction to the bed device to heat to a desired temperature, before the expected bedtime. The desired temperature can be specified by the user, or can be determined automatically, based on the average nightly temperature associated with said user.

**[0066]** FIG. **14** is a flowchart of the process for controlling an appliance, according to another embodiment. The process, at block **1400**, receives current biological signal associated with said user, such as the heart rate, breathing rate, presence, motion, or temperature, associated with said user. Based on the current biological signal, the process, at block **1410**, identifies current sleep phase, such as light sleep, deep sleep, or REM sleep. The process, at block **1420** also receives a current environment property value, such as the temperature, the humidity, the light, or the sound. The process, at block **1430**,

accesses a database, which stores historical values associated with the environment property and the current sleep phase. That is, the database associates each sleep phase with an average historical value of the different environment properties. The database maybe associated with the bed device, maybe associated with the user, or maybe associated with a remote server. The process, at block **1440**, then calculates a new average of the environment property based on the current value of the environment property and the historical value of the environment property, and assigns the new average to the current sleep phase in the database. If there is a mismatch between the current value of the environment property, and the historical average, the process, at block **1450**, regulates the current value to match the historical average. For example, the environment property can be the temperature associated with the bed device. The database stores the average bed temperature corresponding to each of the sleep phase, light sleep, deep sleep, REM sleep. If the current bed temperature is below the historical average, the process sends a control signal to increase the temperature of the bed to match the historical average.

#### Monitoring of Biological Signals

**[0067]** Biological signals associated with a person, such as a heart rate or a breathing rate, indicate said person's state of health. Changes in the biological signals can indicate an immediate onset of a disease, or a long-term trend that increases the risk of a disease associated with said person. Monitoring the biological signals for such changes can predict the onset of a disease, can enable calling for help when the onset of the disease is immediate, or can provide advice to the person if the person is exposed to a higher risk of the disease in the long-term.

**[0068]** FIG. **15** is a diagram of a system for monitoring biological signals associated with a user, and providing notifications or alarms, according to one embodiment. Any number of user sensors **1530**, **1540** monitor bio signals associated with said user, such as temperature, motion, presence, heart rate, or breathing rate. The user sensors **1530**, **1540** communicate their measurements to the processor **1500**. The processor **1500** determines, based on the bio signals associated with said user, historical biological signals associated with said user, or user-specified preferences whether to send a notification or an alarm to a user device **1520**. In some embodiments, the user device **1520** and the processor **1500** can be the same device.

**[0069]** The user device **1520** is any type of a mobile terminal, fixed terminal, or portable terminal including a mobile handset, station, unit, device, multimedia computer, multimedia tablet, Internet node, communicator, desktop computer, laptop computer, notebook computer, netbook computer, tablet computer, personal communication system (PCS) device, personal navigation device, personal digital assistants (PDAs), audio/video player, digital camera/camcorder, positioning device, television receiver, radio broadcast receiver, electronic book device, game device, the accessories and peripherals of these devices, or any combination thereof.

**[0070]** The processor **1500** is any type of microcontroller, or any processor in a mobile terminal, fixed terminal, or portable terminal including a mobile handset, station, unit, device, multimedia computer, multimedia tablet, Internet node, cloud computer, communicator, desktop computer, laptop computer, notebook computer, netbook computer, tablet computer, personal communication system (PCS) device,

personal navigation device, personal digital assistants (PDAs), audio/video player, digital camera/camcorder, positioning device, television receiver, radio broadcast receiver, electronic book device, game device, the accessories and peripherals of these devices, or any combination thereof.

[0071] The processor 1500 can be connected to the user sensor 1530, 1540 by a computer bus, such as an I2C bus. Also, the processor 1500 can be connected to the user sensor 1530, 1540 by a communication network 1510. By way of example, the communication network 1510 connecting the processor 1500 to the user sensor 1530, 1540 includes one or more networks such as a data network, a wireless network, a telephony network, or any combination thereof. The data network may be any local area network (LAN), metropolitan area network (MAN), wide area network (WAN), a public data network (e.g., the Internet), short range wireless network, or any other suitable packet-switched network, such as a commercially owned, proprietary packet-switched network, e.g., a proprietary cable or fiber-optic network, and the like, or any combination thereof. In addition, the wireless network may be, for example, a cellular network and may employ various technologies including enhanced data rates for global evolution (EDGE), general packet radio service (GPRS), global system for mobile communications (GSM), Internet protocol multimedia subsystem (IMS), universal mobile telecommunications system (UMTS), etc., as well as any other suitable wireless medium, e.g., worldwide interoperability for microwave access (WiMAX), Long Term Evolution (LTE) networks, code division multiple access (CDMA), wideband code division multiple access (WCDMA), wireless fidelity (WiFi), wireless LAN (WLAN), Bluetooth®, Internet Protocol (IP) data casting, satellite, mobile ad-hoc network (MANET), and the like, or any combination thereof.

[0072] FIG. 16 is a flowchart of a process for generating a notification based on a history of biological signals associated with a user, according to one embodiment. The process, at block 1600, obtains a history of biological signals, such as the presence history, motion history, breathing rate history, or heart rate history, associated with said user. The history of biological signals can be stored in a database associated with a user. At block 1610, the process determines if there is an irregularity in the history of biological signals within a timeframe. If there is an irregularity, at block 1620, the process generates a notification to the user. The timeframe can be specified by the user, or can be automatically determined based on the type of irregularity. For example, the heart rate associated with said user goes up within a one day timeframe when the user is sick. According to one embodiment, the process detects an irregularity, specifically, that a daily heart rate associated with said user is higher than normal. Consequently, the process warns the user that the user may be getting sick. According to another embodiment, the process detects an irregularity, such as that an elderly user is spending at least 10% more time in bed per day over the last several days, than the historical average. The process generates a notification to the elderly user, or to the elderly user's caretaker, such as how much more time the elderly user is spending in bed. In another embodiment, the process detects an irregularity such as an increase in resting heart rate, by more than 15 beats per minute, over a ten-year period. Such an increase in the resting heart rate doubles the likelihood that the user will die from a heart disease, compared to those

people whose heart rates remained stable. Consequently, the process warns the user that the user is at risk of a heart disease.

[0073] FIG. 17 is a flowchart of a process for generating a comparison between a biological signal associated with a user and a target biological signal, according to one embodiment. The process, at block 1700, obtains a current biological signal associated with a user, such as presence, motion, breathing rate, temperature, or heart rate, associated with said user. The process obtains said current biological signal from a sensor associated with said user. The process, at block 1710, then obtains a target biological signal, such as a user-specified biological signal, a biological signal associated with a healthy user, or a biological signal associated with an athlete. According to one embodiment, the process obtains said target biological signal from a user, or a database storing biological signals. The process, at block 1720, compares current bio signal associated with said user and target bio signal, and generates a notification based on the comparison 1730. The comparison of the current bio signal associated with said user and target bio signal comprises detecting a higher frequency in the current biological signal than in the target biological signal, detecting a lower frequency in the current biological signal than in the target biological signal, detecting higher amplitude in the current biological signal than in the target biological signal, or detecting lower amplitude in the current biological signal than in the target biological signal.

[0074] According to one embodiment, the process of FIG. 17 can be used to detect if an infant has a higher risk of sudden infant death syndrome ("SIDS"). In SIDS victims less than one month of age, heart rate is higher than in healthy infants of same age, during all sleep phases. SIDS victims greater than one month of age show higher heart rates during REM sleep phase. In case of monitoring an infant for a risk of SIDS, the process obtains the current bio signal associated with the sleeping infant, and a target biological signal associated with the heart rate of a healthy infant, where the heart rate is at the high end of a healthy heart rate spectrum. The process obtains the current bio signal from a user sensor associated with the sleeping infant. The process obtains said target biological signal from a database of biological signals. If the frequency of the biological signal of the infant exceeds the target biological signal, the process generates a notification to the infant's caretaker, that the infant is at higher risk of SIDS.

[0075] According to another embodiment, the process of FIG. 17 can be used in fitness training. A normal resting heart rate for adults ranges from 60 to 100 beats per minute. Generally, a lower heart rate at rest implies more efficient heart function and better cardiovascular fitness. For example, a well-trained athlete might have a normal resting heart rate closer to 40 beats per minute. Thus, a user may specify a target rest heart rate of 40 beats per minute. The process FIG. 17 generates a comparison between the actual bio signal associated with said user and the target bio signal 1720, and based on the comparison, the process generates a notification whether the user has reached his target, or whether the user needs to exercise more 1730.

[0076] FIG. 18 is a flowchart of a process for detecting the onset of a disease, according to one embodiment. The process, at block 1800, obtains the current bio signal associated with a user, such as presence, motion, temperature, breathing rate, or heart rate, associated with said user. The process obtains the current bio signal from a sensor associated with said user. Further, the process, at block 1810, obtains a history of bio signals associated with said user from a database. The

history of bio signals comprises the bio signals associated with said user, accumulated over time. The history of biological signals can be stored in a database associated with a user. The process, at block 1820, then detects a discrepancy between the current bio signal and the history of bio signals, where the discrepancy is indicative of an onset of a disease. The process, at block 1830, then generates an alarm to the user's caretaker. The discrepancy between the current bio signal and the history of bio signals comprises a higher frequency in the current bio signal than in the history of bio signals, or a lower frequency in the current bio signal than in the history of bio signals.

[0077] According to one embodiment, the process of FIG. 18 can be used to detect an onset of an epileptic seizure. A healthy person has a normal heart rate between 60 and 100 beats per minute. During epileptic seizures, the median heart rate associated with said person exceeds 100 beats per minute. The process of FIG. 18 detects that the heart rate associated with said user exceeds the normal heart rate range associated with said user. The process then generates an alarm to the user's caretaker that the user is having an epileptic seizure. Although rare, epileptic seizures can cause the median heart rate associated with a person to drop below 40 beats per minute. Similarly, the process of FIG. 18 detects if the current heart rate is below the normal heart rate range associated with said user. The process then generates an alarm to the user's caretaker that the user is having an epileptic seizure.

[0078] FIG. 19 is a diagrammatic representation of a machine in the example form of a computer system 1900 within which a set of instructions, for causing the machine to perform any one or more of the methodologies or modules discussed herein, may be executed.

[0079] In the example of FIG. 19, the computer system 1900 includes a processor, memory, non-volatile memory, and an interface device. Various common components (e.g., cache memory) are omitted for illustrative simplicity. The computer system 1900 is intended to illustrate a hardware device on which any of the components described in the example of FIGS. 1-18 (and any other components described in this specification) can be implemented. The computer system 1900 can be of any applicable known or convenient type. The components of the computer system 1900 can be coupled together via a bus or through some other known or convenient device.

[0080] This disclosure contemplates the computer system 1900 taking any suitable physical form. As example and not by way of limitation, computer system 1900 may be an embedded computer system, a system-on-chip (SOC), a single-board computer system (SBC) (such as, for example, a computer-on-module (COM) or system-on-module (SOM)), a desktop computer system, a laptop or notebook computer system, an interactive kiosk, a mainframe, a mesh of computer systems, a mobile telephone, a personal digital assistant (PDA), a server, or a combination of two or more of these. Where appropriate, computer system 1900 may include one or more computer systems 1900; be unitary or distributed; span multiple locations; span multiple machines; or reside in a cloud, which may include one or more cloud components in one or more networks. Where appropriate, one or more computer systems 1900 may perform without substantial spatial or temporal limitation one or more steps of one or more methods described or illustrated herein. As an example and not by way of limitation, one or more computer systems 1900

may perform in real time or in batch mode one or more steps of one or more methods described or illustrated herein. One or more computer systems 1900 may perform at different times or at different locations one or more steps of one or more methods described or illustrated herein, where appropriate.

[0081] The processor may be, for example, a conventional microprocessor such as an Intel Pentium microprocessor or Motorola power PC microprocessor. One of skill in the relevant art will recognize that the terms "machine-readable (storage) medium" or "computer-readable (storage) medium" include any type of device that is accessible by the processor.

[0082] The memory is coupled to the processor by, for example, a bus. The memory can include, by way of example but not limitation, random access memory (RAM), such as dynamic RAM (DRAM) and static RAM (SRAM). The memory can be local, remote, or distributed.

[0083] The bus also couples the processor to the non-volatile memory and drive unit. The non-volatile memory is often a magnetic floppy or hard disk, a magnetic-optical disk, an optical disk, a read-only memory (ROM), such as a CD-ROM, EPROM, or EEPROM, a magnetic or optical card, or another form of storage for large amounts of data. Some of this data is often written, by a direct memory access process, into memory during execution of software in the computer 1900. The non-volatile storage can be local, remote, or distributed. The non-volatile memory is optional because systems can be created with all applicable data available in memory. A typical computer system will usually include at least a processor, memory, and a device (e.g., a bus) coupling the memory to the processor.

[0084] Software is typically stored in the non-volatile memory and/or the drive unit. Indeed, storing an entire large program in memory may not even be possible. Nevertheless, it should be understood that for software to run, if necessary, it is moved to a computer readable location appropriate for processing, and for illustrative purposes, that location is referred to as the memory in this paper. Even when software is moved to the memory for execution, the processor will typically make use of hardware registers to store values associated with the software, and local cache that, ideally, serves to speed up execution. As used herein, a software program is assumed to be stored at any known or convenient location (from non-volatile storage to hardware registers) when the software program is referred to as "implemented in a computer-readable medium." A processor is considered to be "configured to execute a program" when at least one value associated with the program is stored in a register readable by the processor.

[0085] The bus also couples the processor to the network interface device. The interface can include one or more of a modem or network interface. It will be appreciated that a modem or network interface can be considered to be part of the computer system 1900. The interface can include an analog modem, isdn modem, cable modem, token ring interface, satellite transmission interface (e.g. "direct PC"), or other interfaces for coupling a computer system to other computer systems. The interface can include one or more input and/or output devices. The I/O devices can include, by way of example but not limitation, a keyboard, a mouse or other pointing device, disk drives, printers, a scanner, and other input and/or output devices, including a display device. The display device can include, by way of example but not limitation, a cathode ray tube (CRT), liquid crystal display

(LCD), or some other applicable known or convenient display device. For simplicity, it is assumed that controllers of any devices not depicted in the example of FIG. 9 reside in the interface.

**[0086]** In operation, the computer system 1900 can be controlled by operating system software that includes a file management system, such as a disk operating system. One example of operating system software with associated file management system software is the family of operating systems known as Windows® from Microsoft Corporation of Redmond, Wash., and their associated file management systems. Another example of operating system software with its associated file management system software is the Linux™ operating system and its associated file management system. The file management system is typically stored in the non-volatile memory and/or drive unit and causes the processor to execute the various acts required by the operating system to input and output data and to store data in the memory, including storing files on the non-volatile memory and/or drive unit.

**[0087]** Some portions of the detailed description may be presented in terms of algorithms and symbolic representations of operations on data bits within a computer memory. These algorithmic descriptions and representations are the means used by those skilled in the data processing arts to most effectively convey the substance of their work to others skilled in the art. An algorithm is here, and generally, conceived to be a self-consistent sequence of operations leading to a desired result. The operations are those requiring physical manipulations of physical quantities. Usually, though not necessarily, these quantities take the form of electrical or magnetic signals capable of being stored, transferred, combined, compared, and otherwise manipulated. It has proven convenient at times, principally for reasons of common usage, to refer to these signals as bits, values, elements, symbols, characters, terms, numbers, or the like.

**[0088]** It should be borne in mind, however, that all of these and similar terms are to be associated with the appropriate physical quantities and are merely convenient labels applied to these quantities. Unless specifically stated otherwise as apparent from the following discussion, it is appreciated that throughout the description, discussions utilizing terms such as “processing” or “computing” or “calculating” or “determining” or “displaying” or “generating” or the like, refer to the action and processes of a computer system, or similar electronic computing device, that manipulates and transforms data represented as physical (electronic) quantities within the computer system’s registers and memories into other data similarly represented as physical quantities within the computer system memories or registers or other such information storage, transmission or display devices.

**[0089]** The algorithms and displays presented herein are not inherently related to any particular computer or other apparatus. Various general purpose systems may be used with programs in accordance with the teachings herein, or it may prove convenient to construct more specialized apparatus to perform the methods of some embodiments. The required structure for a variety of these systems will appear from the description below. In addition, the techniques are not described with reference to any particular programming language, and various embodiments may thus be implemented using a variety of programming languages.

**[0090]** In alternative embodiments, the machine operates as a standalone device or may be connected (e.g., networked) to other machines. In a networked deployment, the machine

may operate in the capacity of a server or a client machine in a client-server network environment, or as a peer machine in a peer-to-peer (or distributed) network environment.

**[0091]** The machine may be a server computer, a client computer, a personal computer (PC), a tablet PC, a laptop computer, a set-top box (STB), a personal digital assistant (PDA), a cellular telephone, an iPhone, a Blackberry, a processor, a telephone, a web appliance, a network router, switch or bridge, or any machine capable of executing a set of instructions (sequential or otherwise) that specify actions to be taken by that machine.

**[0092]** While the machine-readable medium or machine-readable storage medium is shown in an exemplary embodiment to be a single medium, the term “machine-readable medium” and “machine-readable storage medium” should be taken to include a single medium or multiple media (e.g., a centralized or distributed database, and/or associated caches and servers) that store the one or more sets of instructions. The term “machine-readable medium” and “machine-readable storage medium” shall also be taken to include any medium that is capable of storing, encoding or carrying a set of instructions for execution by the machine and that cause the machine to perform any one or more of the methodologies or modules of the presently disclosed technique and innovation.

**[0093]** In general, the routines executed to implement the embodiments of the disclosure, may be implemented as part of an operating system or a specific application, component, program, object, module or sequence of instructions referred to as “computer programs.” The computer programs typically comprise one or more instructions set at various times in various memory and storage devices in a computer, and that, when read and executed by one or more processing units or processors in a computer, cause the computer to perform operations to execute elements involving the various aspects of the disclosure.

**[0094]** Moreover, while embodiments have been described in the context of fully functioning computers and computer systems, those skilled in the art will appreciate that the various embodiments are capable of being distributed as a program product in a variety of forms, and that the disclosure applies equally regardless of the particular type of machine or computer-readable media used to actually effect the distribution.

**[0095]** Further examples of machine-readable storage media, machine-readable media, or computer-readable (storage) media include but are not limited to recordable type media such as volatile and non-volatile memory devices, floppy and other removable disks, hard disk drives, optical disks (e.g., Compact Disk Read-Only Memory (CD ROMS), Digital Versatile Disks, (DVDs), etc.), among others, and transmission type media such as digital and analog communication links.

**[0096]** In some circumstances, operation of a memory device, such as a change in state from a binary one to a binary zero or vice-versa, for example, may comprise a transformation, such as a physical transformation. With particular types of memory devices, such a physical transformation may comprise a physical transformation of an article to a different state or thing. For example, but without limitation, for some types of memory devices, a change in state may involve an accumulation and storage of charge or a release of stored charge. Likewise, in other memory devices, a change of state may comprise a physical change or transformation in magnetic

orientation or a physical change or transformation in molecular structure, such as from crystalline to amorphous or vice versa. The foregoing is not intended to be an exhaustive list of all examples on page in which a change in state for a binary one to a binary zero or vice-versa in a memory device may comprise a transformation, such as a physical transformation. Rather, the foregoing is intended as illustrative examples.

**[0097]** A storage medium typically may be non-transitory or comprise a non-transitory device. In this context, a non-transitory storage medium may include a device that is tangible, meaning that the device has a concrete physical form, although the device may change its physical state. Thus, for example, non-transitory refers to a device remaining tangible despite this change in state.

#### REMARKS

**[0098]** In many of the embodiments disclosed in this application, the technology is capable of allowing multiple different users to use the same piece of furniture equipped with the presently disclosed technology. For example, different people can sleep in the same bed. In addition, two different users can switch the side of the bed that they sleep on, and the technology disclosed here will correctly identify which user is sleeping on which side of the bed. The technology identifies the users based on any of the following signals alone or in combination: heart rate, breathing rate, body motion, or body temperature associated with each user.

**[0099]** The foregoing description of various embodiments of the claimed subject matter has been provided for the purposes of illustration and description. It is not intended to be exhaustive or to limit the claimed subject matter to the precise forms disclosed. Many modifications and variations will be apparent to one skilled in the art. Embodiments were chosen and described in order to best describe the principles of the invention and its practical applications, thereby enabling others skilled in the relevant art to understand the claimed subject matter, the various embodiments, and the various modifications that are suited to the particular uses contemplated.

**[0100]** While embodiments have been described in the context of fully functioning computers and computer systems, those skilled in the art will appreciate that the various embodiments are capable of being distributed as a program product in a variety of forms, and that the disclosure applies equally regardless of the particular type of machine or computer-readable media used to actually effect the distribution.

**[0101]** Although the above Detailed Description describes certain embodiments and the best mode contemplated, no matter how detailed the above appears in text, the embodiments can be practiced in many ways. Details of the systems and methods may vary considerably in their implementation details, while still being encompassed by the specification. As noted above, particular terminology used when describing certain features or aspects of various embodiments should not be taken to imply that the terminology is being redefined herein to be restricted to any specific characteristics, features, or aspects of the invention with which that terminology is associated. In general, the terms used in the following claims should not be construed to limit the invention to the specific embodiments disclosed in the specification, unless those terms are explicitly defined herein. Accordingly, the actual scope of the invention encompasses not only the disclosed embodiments, but also all equivalent ways of practicing or implementing the embodiments under the claims.

**[0102]** The language used in the specification has been principally selected for readability and instructional purposes, and it may not have been selected to delineate or circumscribe the inventive subject matter. It is therefore intended that the scope of the invention be limited not by this Detailed Description, but rather by any claims that issue on an application based hereon. Accordingly, the disclosure of various embodiments is intended to be illustrative, but not limiting, of the scope of the embodiments, which is set forth in the following claims.

1. A bed system for automatically heating a mattress comprising:

a bed pad device configured to receive an instruction to heat said mattress to a specified temperature, said bed pad device comprising a mattress cover, said mattress cover further comprising:

a sensor strip, wherein said sensor strip comprises a user sensor configured to measure a biological signal associated with a user, wherein said biological signal comprises a heart rate associated with said user, and a breathing rate associated with said user; and

a coil configured to heat said mattress; and

an environment sensor, configured to measure an environment property, wherein said environment property comprises a temperature, a humidity, a light intensity, or a sound; and

a computer processor communicatively coupled to said bed pad device and said environment sensor, said computer processor configured to:

determine, based on said biological signal associated with said user and said environment property, a control signal, and a time to send said control signal; and send said control signal at said time to said bed pad device.

2. The bed system of claim 1, wherein said computer processor determines presence associated with said user, and motion associated with said user, based on said biological signal associated with said user.

3. The bed system of claim 1, wherein said computer processor is configured to receive an input from said user, and wherein said computer processor is configured to determine at least one of said control signal, or said time, based on said input from said user.

4. The bed system of claim 1, further comprising: a fabric, a batting, or a waterproof material.

5. The bed system of claim 1, wherein said time comprises an average bedtime associated with said user.

6. The bed system of claim 1, wherein said control signal comprises an instruction to heat said coil to a high temperature, wherein said high temperature comprises an average high temperature associated with said user.

7. A bed system comprising:

a user sensor configured to measure a biological signal associated with a user; and

an environment sensor, configured to measure an environment property; and

a bed device configured to receive a control signal; and

a computer processor communicatively coupled to said user sensor and said environment sensor, and further communicatively coupled to said bed device, said computer processor configured to:

- determine, based on said biological signal associated with said user and said environment property, the control signal, and a time to send said control signal to said bed device; and
- send said control signal at said time to said bed device.
- 8.** The bed system of claim **7**, wherein said bed device comprises a coil.
- 9.** The bed system of claim **8** further comprising: a fabric, a batting, or a waterproof material.
- 10.** The bed system of claim **9**, wherein said batting comprises a sensor strip, wherein said sensor strip comprises said user sensor and a computer bus.
- 11.** The bed system of claim **7**, wherein said time comprises an average daily bedtime associated with said user.
- 12.** The bed system of claim **7**, wherein said biological signal corresponds to at least one of: a presence associated with said user, a motion associated with said user, a temperature associated with said user, a breathing rate associated with said user, or a heart rate associated with said user.
- 13.** The bed system of claim **7**, wherein said user sensor comprises at least one of a piezo sensor, or a temperature sensor.
- 14.** The bed system of claim **7**, wherein said control signal comprises an instruction to heat said bed device to a high temperature, wherein said high temperature is determined based on said biological signal associated with said user.
- 15.** The bed system of claim **7**, wherein said control signal comprises an instruction to cool said bed device to a low temperature, wherein said low temperature is determined based on said biological signal associated with said user.
- 16.** The bed system of claim **7**, wherein said environment property comprises temperature, humidity, light, or sound.
- 17.** The bed system of claim **7**, wherein said computer processor is configured to receive input from said user, whereby said computer processor, based on said input from said user, determines said time to send said control signal to said bed device.
- 18.** A system comprising:  
 a user sensor configured to measure a biological signal associated with a user; and  
 an environment sensor, configured to measure an environment property; and  
 a transceiver communicatively coupled to said user sensor and said environment sensor, said transceiver configured to transmit said biological signal associated with said user and said environment property, and further said transceiver configured to receive a control signal; and  
 a bed device, communicatively coupled to said transceiver, wherein said bed device is configured to respond to said control signal.
- 19.** The system of claim **18**, wherein said biological signal associated with said user corresponds to at least one of a temperature associated with said user, a presence associated with said user, a motion associated with said user, a breathing rate associated with said user, or a heart rate associated with said user.
- 20.** The system of claim **18**, wherein said environment property comprises a temperature, a humidity, a light intensity, or a sound.
- 21.** The system of claim **18**, wherein said control signal comprises an instruction to heat said bed device to a high temperature, wherein said high temperature comprises an average high temperature associated with said user.
- 22.** The system of claim **18**, wherein said control signal comprises an instruction to cool said bed device to a low temperature, wherein said low temperature comprises an average low temperature associated with said user.
- 23.** A method comprising:  
 obtaining a biological signal associated with a user from a sensor;  
 obtaining a history of biological signals associated with said user from a database associated with said user;  
 obtaining an environment property from an environment sensor associated with a bed device;  
 determining, based on said biological signal associated with said user, said history of biological signals associated with said user, and said environment property, a control signal, and a time to send said control signal to said bed device; and  
 sending said control signal at said time to said bed device.
- 24.** The method of claim **23**, wherein obtaining said history of biological signals comprises:  
 obtaining a plurality of average bedtimes associated with said user, wherein said plurality of average bedtimes comprises average bedtime on one or more days of a week.
- 25.** The method of claim **23**, wherein obtaining said biological signal comprises:  
 obtaining at least one of: a presence associated with said user, a motion associated with said user, a breathing rate associated with said user, a temperature associated with said user, or a heart rate associated with said user.
- 26.** The method of claim **23**, wherein sending said control signal comprises:  
 sending an instruction to heat said bed device to a high temperature, wherein said high temperature comprises an average high temperature associated with said user.
- 27.** The method of claim **23**, wherein sending said control signal comprises:  
 sending an instruction to cool said bed device to a low temperature, wherein said low temperature comprises an average low temperature associated with said user.
- 28.** The method of claim **23**, wherein obtaining said environment property comprises:  
 obtaining a temperature, a humidity, a light intensity, or a sound.
- 29.** The method of claim **23**, wherein determining said time to send said control signal to said bed device comprises calculating an average daily bedtime associated with said user.

专利名称(译)	床装置系统和方法		
公开(公告)号	<a href="#">US20150351556A1</a>	公开(公告)日	2015-12-10
申请号	US14/732646	申请日	2015-06-05
[标]申请(专利权)人(译)	MORPHY		
申请(专利权)人(译)	MORPHY INC.		
当前申请(专利权)人(译)	MORPHY INC.		
[标]发明人	FRANCESCHETTI MATTEO BASSI MASSIMO ANDREASI		
发明人	FRANCESCHETTI, MATTEO BASSI, MASSIMO ANDREASI		
IPC分类号	A47C21/04 H05B1/02 A61B5/00 A61B5/08 A61B5/01 A61B5/11 A47G9/02 A61B5/0205		
CPC分类号	A47C21/048 A47G9/0238 A47C21/044 H05B1/0272 A61B5/4812 A61B5/08 A61B5/01 A61B5/11 A61B5/0205		
优先权	62/008480 2014-06-05 US 62/024945 2014-07-15 US 62/159177 2015-05-08 US 62/161142 2015-05-13 US		
外部链接	<a href="#">Espacenet</a> <a href="#">USPTO</a>		

摘要(译)

介绍了一种床装置系统和方法，用于：收集人体生物信号，例如心率，呼吸速率或温度；分析收集的人体生物信号；基于分析控制床装置系统，例如床装置的温度。

