



US 20090149927A1

(19) **United States**  
(12) **Patent Application Publication**  
**Kneuer et al.**

(10) **Pub. No.: US 2009/0149927 A1**  
(43) **Pub. Date: Jun. 11, 2009**

(54) **METHOD AND APPARATUS FOR CONTROLLING A WARMING THERAPY DEVICE**

(22) Filed: **Nov. 14, 2008**

**Related U.S. Application Data**

(75) Inventors: **Harald Kneuer**, Ambler, PA (US); **Thorsten Waloschek**, Flemington, NJ (US); **Peter Medico**, Breinigsville, PA (US); **John Richards**, Warrington, PA (US); **Ines Poggensee**, Heilshoop (DE); **Nancy Files**, Perkasio, PA (US); **Philip Moehring**, Luebeck (DE)

(60) Provisional application No. 61/005,510, filed on Dec. 5, 2007.

**Publication Classification**

(51) **Int. Cl.**  
*A61F 7/00* (2006.01)  
*A61B 5/01* (2006.01)  
*A61B 5/00* (2006.01)  
*G06F 3/041* (2006.01)

(52) **U.S. Cl.** ..... **607/96; 600/301; 345/173**

Correspondence Address:  
**IP GROUP OF DLA PIPER US LLP (DMI)**  
**ONE LIBERTY PLACE, 1650 MARKET STREET, SUITE 4900**  
**PHILADELPHIA, PA 19103 (US)**

(57) **ABSTRACT**

An apparatus and method for controlling a warming therapy device (e.g., incubator, warmer, etc.) is described. In one exemplary embodiment, the apparatus includes a Graphical User Interface (GUI) coupled to the warming therapy device for monitoring patient medical information, and for controlling various aspects of the warming therapy device accordingly.

(73) Assignee: **Draeger Medical Systems, Inc.**, Telford, PA (US)

(21) Appl. No.: **12/271,225**

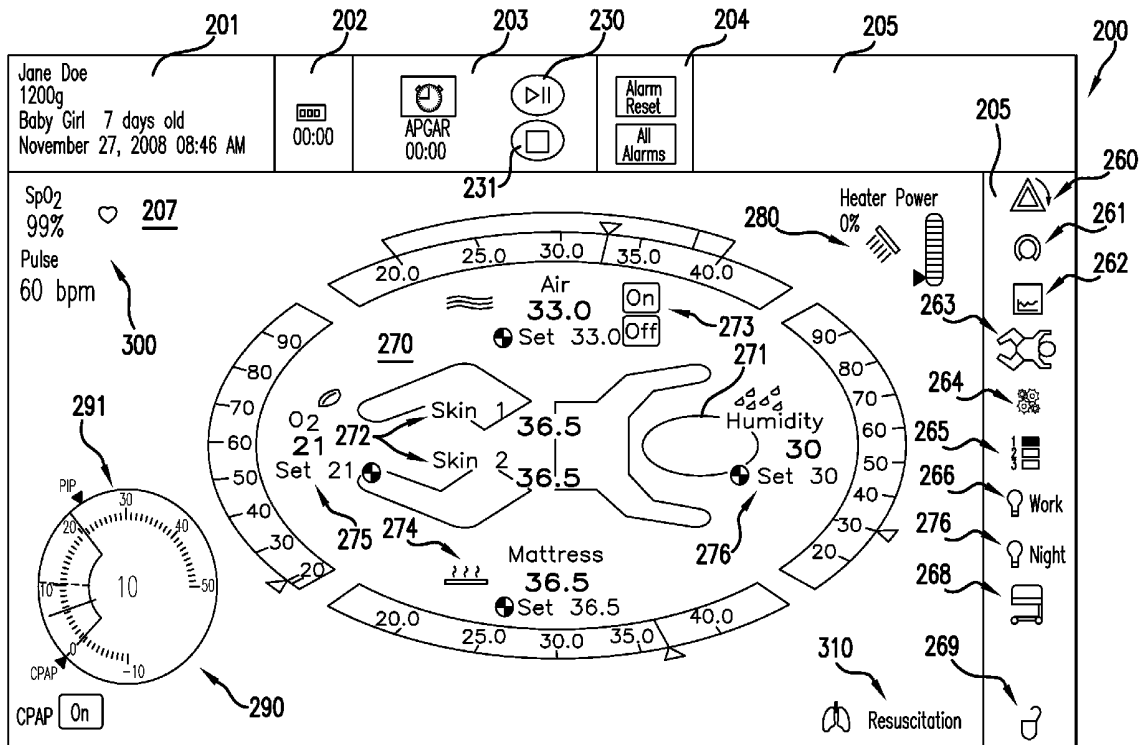

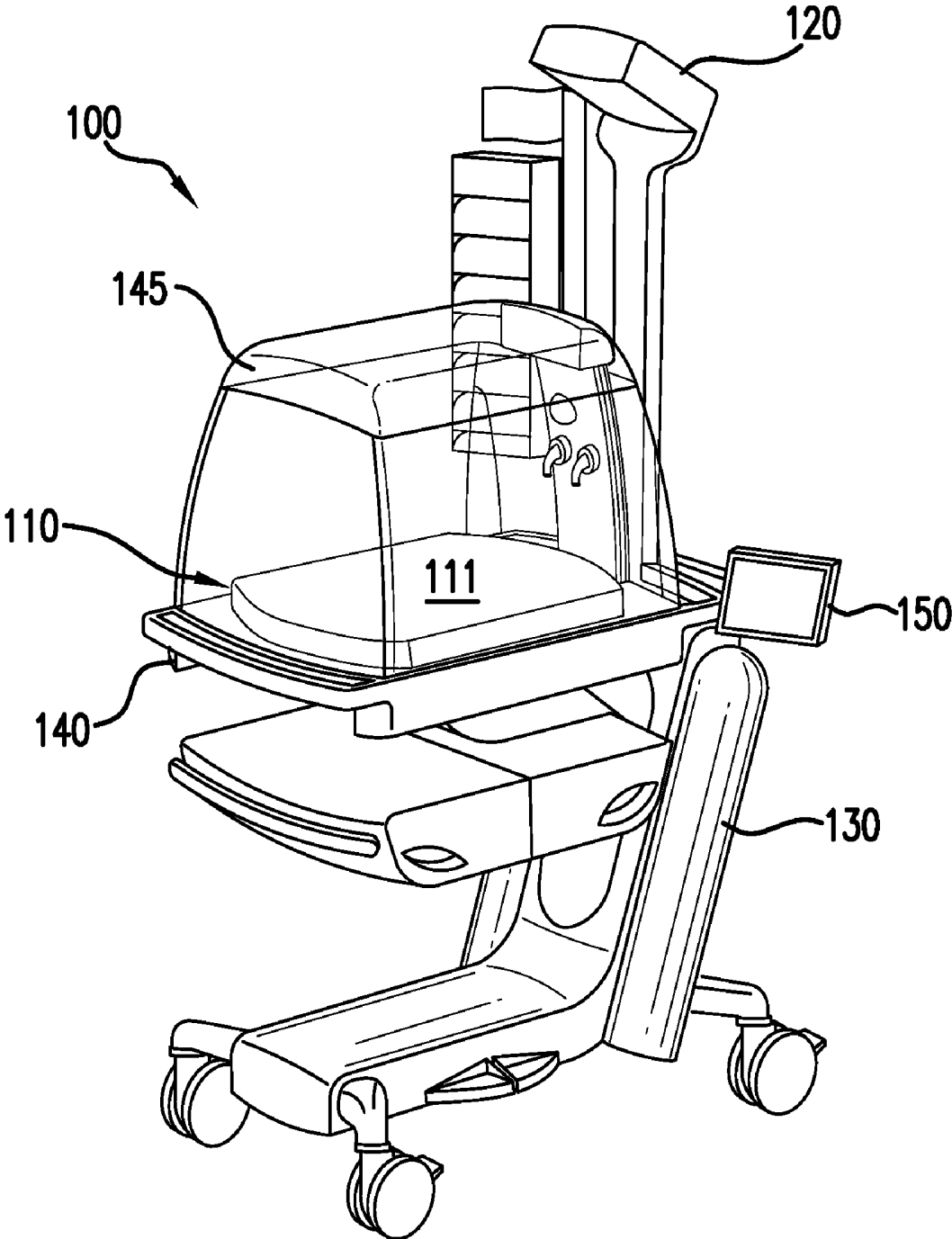

FIG. 1

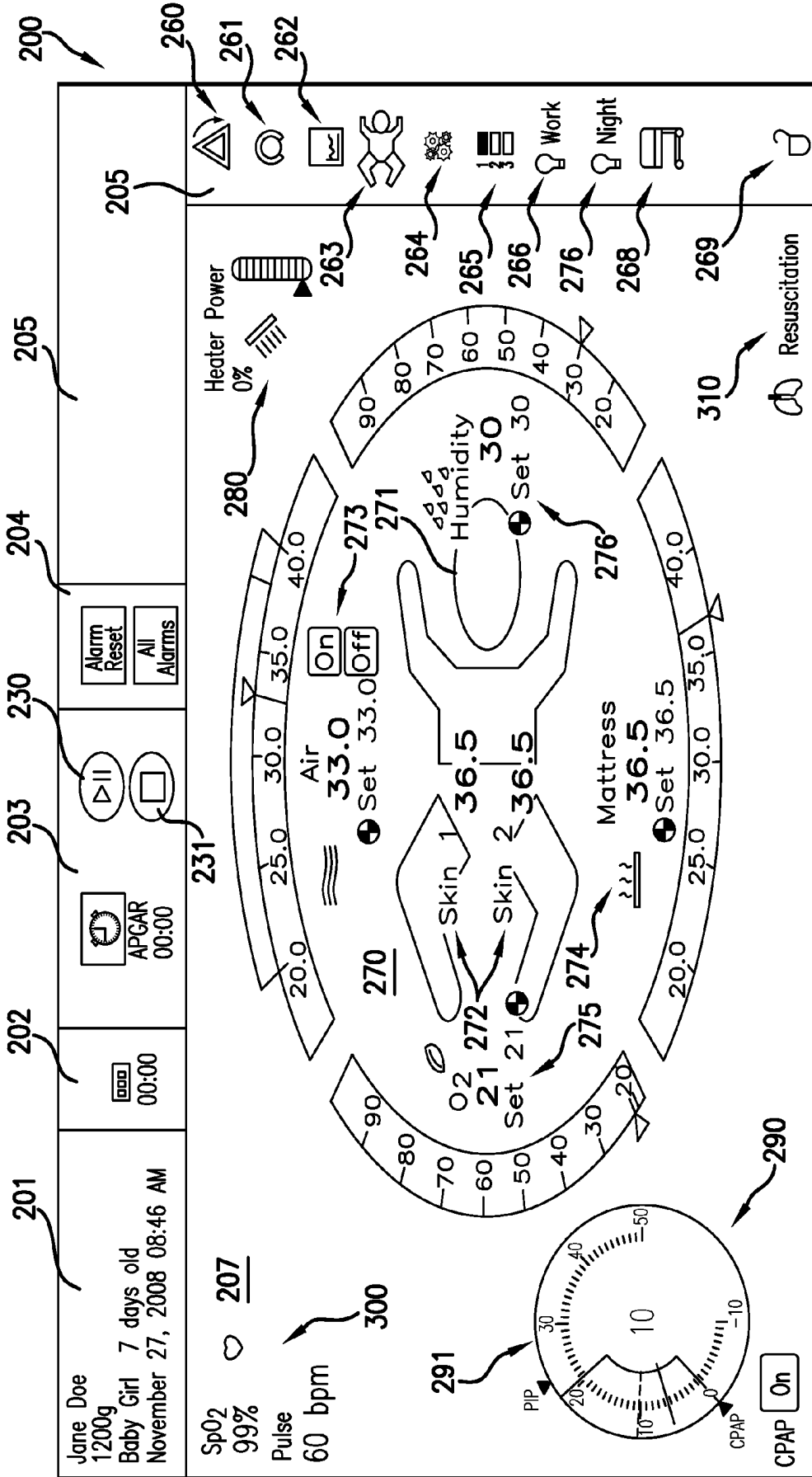

FIG.2

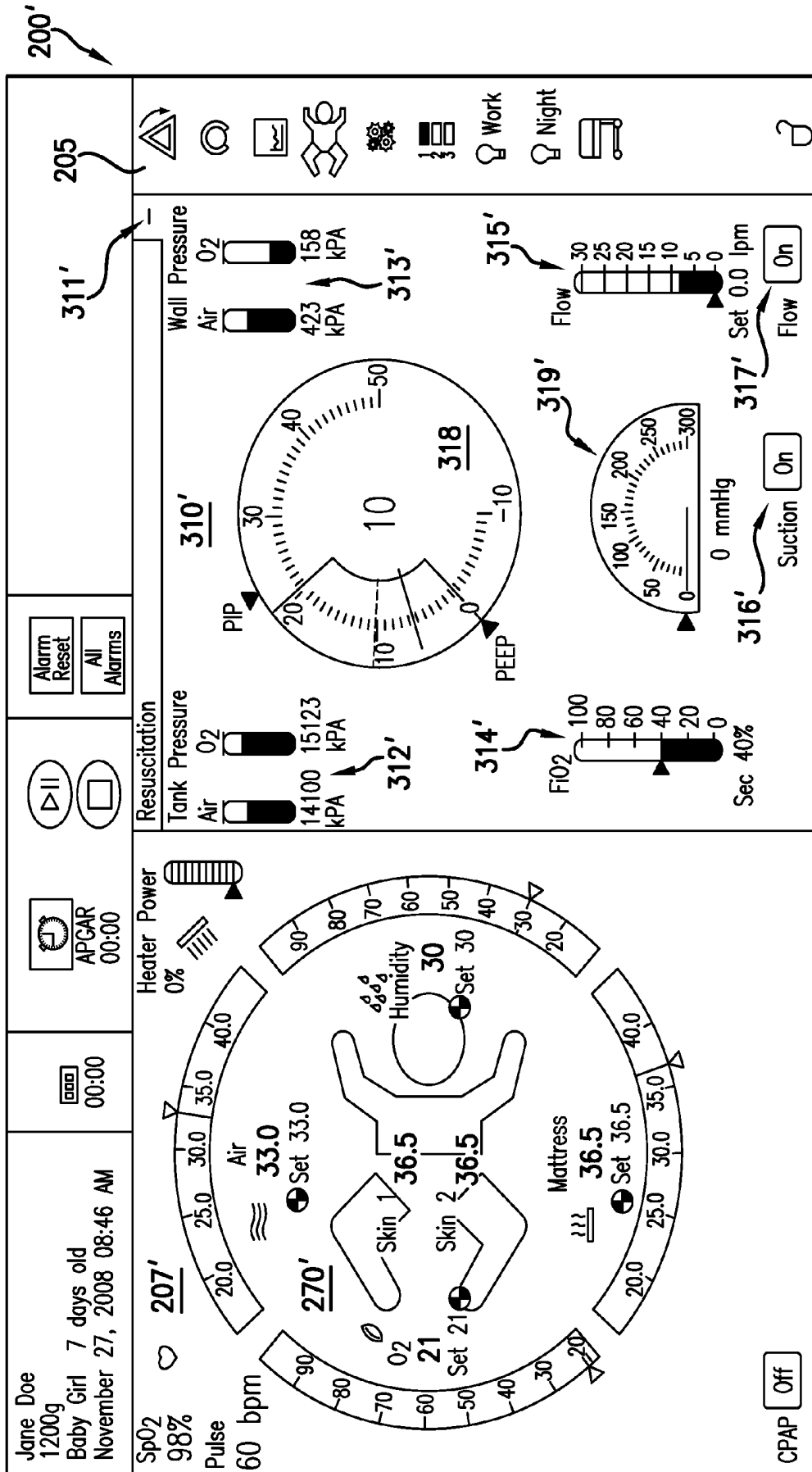

FIG.3

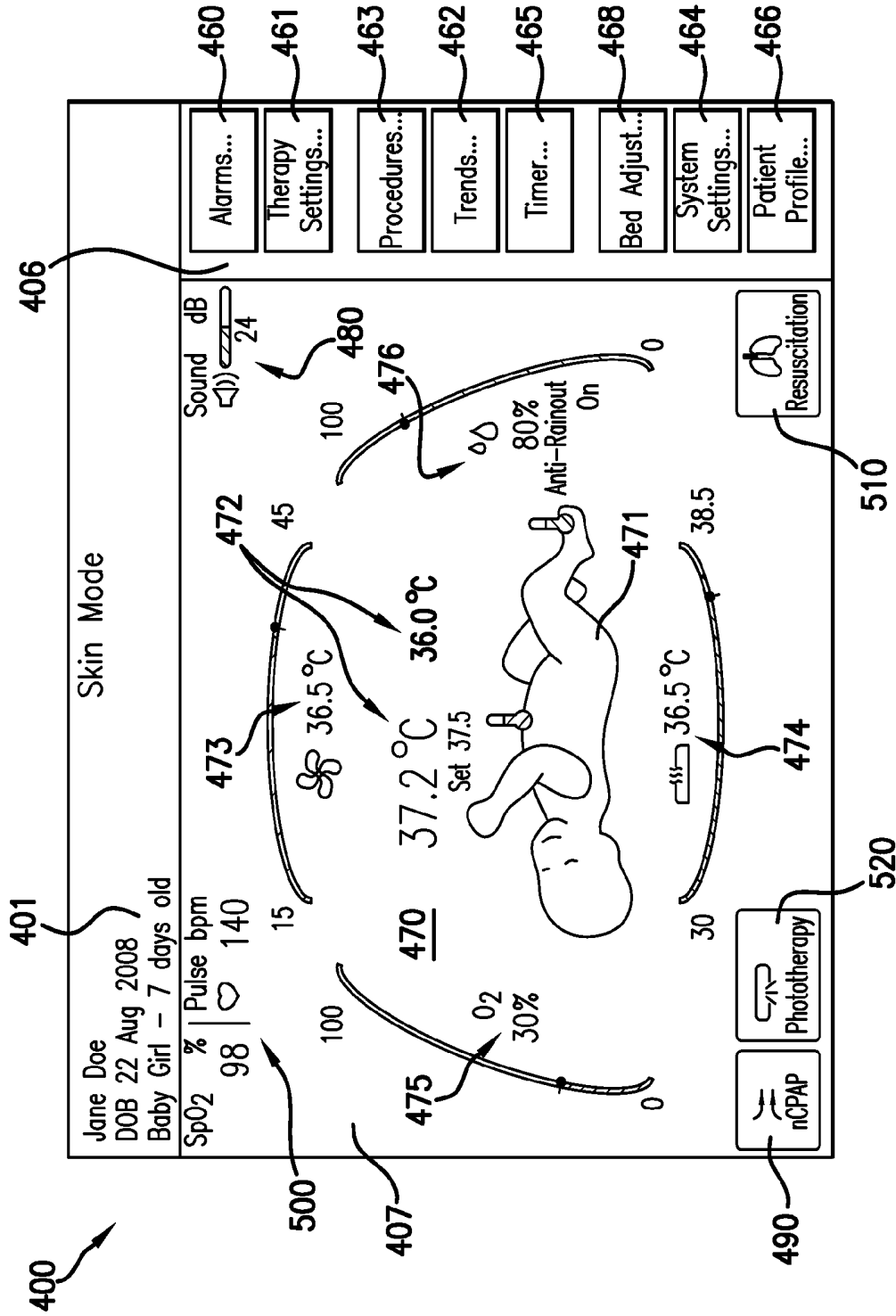
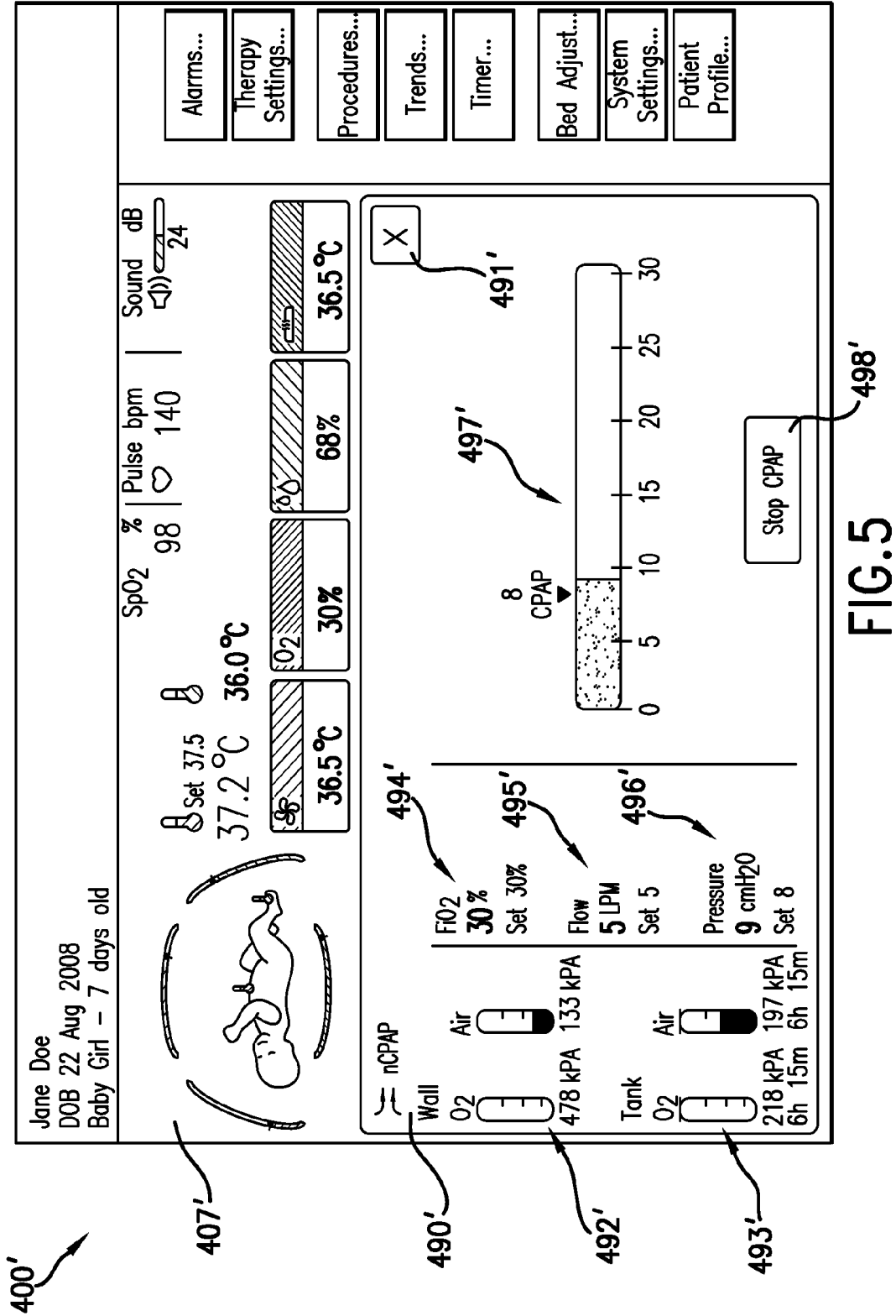

FIG. 4



**FIG. 5**





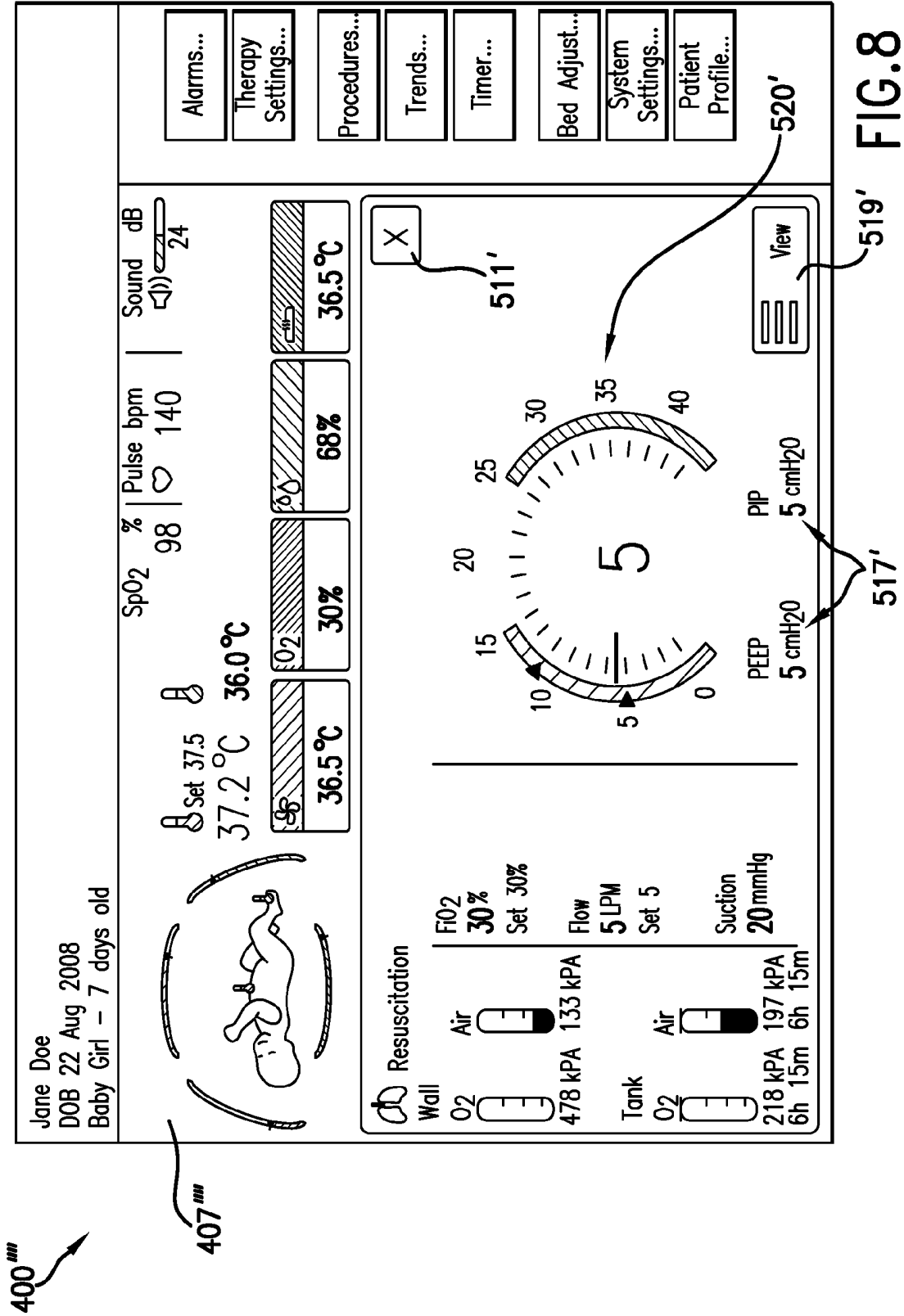

FIG. 8

## METHOD AND APPARATUS FOR CONTROLLING A WARMING THERAPY DEVICE

### CROSS REFERENCE TO RELATED APPLICATIONS

[0001] This application claims priority to U.S. Provisional Patent Application No. 61/005,510, filed Dec. 5, 2007, the entire contents of which are incorporated by reference, as if fully set forth herein.

### FIELD OF THE INVENTION

[0002] The present invention relates generally to a method and apparatus for controlling a warming therapy device (e.g., incubator, warmer, etc.). More particularly, the present invention relates to a method and apparatus for monitoring the conditions of a medical patient disposed on a warming therapy device, and controlling various aspects of the warming therapy device associated therewith.

### BACKGROUND OF THE INVENTION

[0003] Infant care units, such as warming therapy devices (e.g., incubators, warmers, etc.) that includes various systems for controlling the temperature and humidity to facilitate the development of a premature infant, are known. Such devices conventionally include an infant support surface for supporting an infant, as well as means of protecting the infant, such as a hood or canopy which covers the infant support surface.

[0004] In some cases, conventional warming therapy devices include control panels for monitoring the status of the infant, and for controlling various aspects of the device (e.g., temperature, air flow, humidity, etc.). Such control panels typically comprise an Light Emitting Diode (LED) or Liquid Crystal Display (LCD) type displays, which convey only alphanumeric information (e.g., temperature values, humidity values), and are often time not intuitive to first time users. Conventional control panels for warming therapy devices do not include detailed display monitors (such as computer-type displays), touch-screen displays, or other features common in the field of computers.

[0005] Accordingly, there is presently a need for an apparatus for monitoring and controlling a warming therapy device which is intuitive and suitable for an infant patient environment.

### SUMMARY OF THE INVENTION

[0006] An exemplary embodiment Of the present invention comprises an apparatus including a warming therapy device and at least one monitor coupled to the warming therapy device for displaying information related to a medical patient, wherein the monitor operates to display at least one medical patient temperature level, and at least one resuscitation indicator on a single display screen.

[0007] An exemplary embodiment of the present invention also comprises a touch screen apparatus including a first display portion for displaying a first set of information related to a medical patient, a second display portion for displaying menu information, and a third display portion for displaying a second set of information related to a medical patient.

[0008] An exemplary embodiment of the present invention also comprises a method for monitoring a medical patient, including, displaying a first set of information related to a medical patient on a first portion of a computer monitor,

displaying menu information on a second portion of a computer monitor, and displaying a second set of information related to a medical patient on a third portion of a computer monitor.

[0009] An exemplary embodiment of the present invention also comprises a computer system including at least one monitor, at least one processor, and at least one memory coupled to the at least one processor, wherein the at least one memory includes at least one program stored thereon, the at least one program being capable of performing the steps of displaying a first set of information related to a medical patient on a first portion of the at least one monitor, displaying menu information on a second portion of the at least one monitor, and displaying a second set of information related to a medical patient on a third portion of the at least one monitor.

[0010] An exemplary embodiment of the present invention also comprises a computer readable medium having embodied therein a computer program for processing by a machine, the computer program including a first code segment for displaying a first set of information related to a medical patient on a first portion of a computer monitor, a second code segment for displaying menu information on a second portion of the computer monitor, and a third code segment for displaying a second set of information related to a medical patient on a third portion of the computer monitor.

[0011] An exemplary embodiment of the present invention also comprises a computer monitor apparatus including a first display portion for displaying an image representative of a medical patient, a second display portion for displaying a first set of information related to a medical patient, wherein the second display portion comprises a substantially circular display which substantially surrounds the first display portion.

[0012] An exemplary embodiment of the present invention also comprises an apparatus including a warming therapy device, and at least one monitor coupled to the warming therapy device for displaying information related to a medical patient, wherein the monitor operates to display at least one medical patient temperature level, and at least one CPAP indicator on a single display screen.

### BRIEF DESCRIPTION OF THE DRAWINGS

[0013] FIG. 1 is perspective view of a warming therapy device according to a first exemplary embodiment of the present invention.

[0014] FIG. 2 is front view of a computer monitor associated with the warming therapy device shown in FIG. 1, showing a touch screen Graphical User Interface (GUI) according to a first exemplary embodiment of the present invention.

[0015] FIG. 3 is an alternative front view of the GUI of FIG. 2, showing the resuscitation portion expanded.

[0016] FIG. 4 is front view of a computer monitor associated with the warming therapy device shown in FIG. 1, showing a touch screen Graphical User Interface (GUI) according to a second exemplary embodiment of the present invention.

[0017] FIG. 5 is an alternative front view of the GUI of FIG. 4, showing the nCPAP portion expanded.

[0018] FIG. 6 is an alternative front view of the GUI of FIG. 4, showing the nCPAP portion expanded.

[0019] FIG. 7 is an alternative front view of the GUI of FIG. 4, showing the resuscitation portion expanded.

[0020] FIG. 8 is an alternative front view of the GUI of FIG. 4, showing the resuscitation portion expanded.

#### DETAILED DESCRIPTION

[0021] The present invention relates generally to a method and apparatus for controlling a warming therapy device (e.g., incubator, warmer, etc.), and in particular to an interface for displaying various conditions of a medical patient disposed on the warming therapy device, and for permitting-control of various medical monitors and devices. As described below, the interface may comprise a touch screen Graphical User Interface (GUI) in certain exemplary embodiments.

[0022] The GUI presents a completely new holistic approach to the control and monitoring of an infant patient disposed on or in the warming therapy device. In certain exemplary embodiments, the GUI may comprise a full-color touch screen display which allows for customization of the displayed information according to the user's needs. For example the arrangement of data on the GUI may follow the current medical application, which can include, but is not limited to, processes such as thermo-regulation (i.e., temperature control), thermo-monitoring (i.e., temperature monitoring), phototherapy, respiratory support, resuscitation, noise control, audio stimulation, weighing, etc. Short and long-term trends may also be displayed on the GUI, and combined for further analysis. The GUI may also include a series of alarms, as well as an alarm log, which may be combined with the short and long-term trend information for analysis, and future prevention of similar events.

[0023] The GUI is intended to represent a patient and the patient's environment on the GUI, and to place the measured values and indicators relating to the patient and the patient's environment at locations on the GUI that correspond to their physical location. For example, a mattress temperature value may be represented on a bottom portion of the GUI (under the representation of the patient), which corresponds to the location of the mattress in the warming therapy device relative to the patient. One goal of the present invention is to make the use of the GUI more intuitive to first time users, and more effective to repeat users. Another goal is to make the GUI better suited for an infant patient environment (e.g., Neonatal Intensive Care Unit (NICU)) in that its appearance is less foreign (and less threatening) to visiting parents, while still remaining effective and professional.

[0024] The following abbreviations are used herein, and are defined as follows:

[0025] bpm—beats per minute, unit for pulse rate.

[0026] CPAP—Continuous Positive Airway Pressure; used to keep airways open.

[0027] FiO<sub>2</sub>—Fractional Inspired O<sub>2</sub> concentration.

[0028] GUI—Graphical User Interface.

[0029] KPa—KiloPascals, Unit of pressure (1 KPa=0.145038 PSI).

[0030] LPM—Liters Per Minute, Unit of gas flow.

[0031] MIB—Medical Information Bus.

[0032] nCPAP—Nasal CPAP.

[0033] NICU—Neonatal Intensive Care Unit.

[0034] PEEP—Positive End Expiratory Pressure; pressure applied to the patient airway during expiration.

[0035] PIP—Peak Inspiratory Pressure; the pressure limit of the gas possible to deliver.

[0036] PSI—Pounds per Square inch; unit of gas pressure (1 PSI=6.8947 KPa).

[0037] Trendelenburg—a position in which a patient's body is laid flat on the back with the head lower than the pelvis.

[0038] FIG. 1 shows a warming therapy device (e.g., incubator, warmer, etc.) 100 according to a first exemplary embodiment of the present invention. The warming therapy device 100 includes a radiant heater head 120, a patient support assembly 130, and a mattress tray assembly 140. The mattress tray assembly 140 may also include a hood 145, and a mattress tray 110, with a mattress 111 disposed therein. Additionally, the warming therapy device 100 may include at least one computer monitor 150 for displaying various information associated with a patient disposed on the warming therapy device. The computer monitor may be coupled to the patient support assembly 130 of the warming therapy device 100 in either a wired or wireless manner. If the computer monitor 150 is wirelessly coupled to the patient support assembly 130, a caregiver can remove the monitor from the assembly and move around with it within a wireless coverage zone. In such an embodiment, the monitor 150 would preferably include a rechargeable internal battery which would provide power during wireless use. Similarly, the patient support assembly 130 would preferably include a charging unit for the internal battery, to charge the monitor 150 when it is stationed on the assembly. Although the computer monitor 150 is shown as being coupled to the patient support assembly 130 in FIG. 1, those of ordinary skill in the art will realize that the computer monitor may be coupled to any suitable portion of the warming therapy device 100, or may be coupled to a separate unit entirely, without departing from the scope of the present invention.

[0039] FIG. 2 shows a Graphical User Interface (GUI) 200 according to a first exemplary embodiment of the present invention which may be displayed on the monitor 150 discussed above. In the first exemplary embodiment, the GUI 200 comprises a 'touch screen' (as is known in the art) which is capable of receiving input from a user (e.g., caregiver) by the user touching various portions of a monitor (e.g., monitor 150) associated with the GUI. The GUI 200 includes a patient information portion 201, which can display various personal information associated with the patient, such as name, weight, sex, and age. The patient information portion 201 can also display the current date and time for reference purposes. The GUI 200 also includes a battery indicator portion 202 which shows the charge level of the internal battery. The battery indicator portion 202 is important when the caregiver is operating the monitor 150 wirelessly (as described above), as it indicates when the monitor must be placed back on the patient support assembly for recharge.

[0040] The GUI 200 also includes an APGAR portion 203 for assisting the caregiver in performing an APGAR examination. The APGAR portion 203 includes a timer which may be started or stopped by selection of the 'play/pause' radio button, and which may be reset by selection of the 'reset' radio button 231. Preferably, an audible alarm sounds at 1, 5 and 10 minute intervals during the APGAR examination.

[0041] The GUI 200 also includes an alarm control portion 204 for controlling various alarms. The alarm control portion 204 includes an 'Alarm Reset' radio button 240, which, when selected, resets all the alarms controlled from the GUI 200. The alarm control portion 204 includes an 'All Alarms' radio button 241, which, when selected, displays an additional dialog box or window (not shown) with a description of all the alarms controlled from the GUI 200. The GUI 200 also

includes an alarm display portion **205** for displaying an indicator of one or more alarms. For example, if the patient's FiO<sub>2</sub> is low, the alarm display portion **205** will display the text "FiO<sub>2</sub> Low" and so forth.

**[0042]** The GUI **200** also includes a main menu portion **206** for allowing the caregiver to perform various functions. The main menu portion **206** includes an Alarm icon **260**, a Therapy Settings icon **261**, a Trends/Review icon **262**, a Procedures icon **263**, a System Setup icon **264**, a View icon **265**, a Work Light icon **266**, a Night Light icon **267**, a Bed Adjustment icon **268**, and a Screen Lock icon **269**. Although not shown in FIG. 2, the main menu portion **206** may include additional icons for performing additional functions, such as, a Hood icon for opening and closing the hood **145**, a Tilt icon for tilting the mattress tray assembly **140**, and a Help icon for accessing help information for the GUI.

**[0043]** If the caregiver selects the Alarm icon **260**, a separate dialog box or window is displayed (not shown) which allows the caregiver to manipulate the alarm settings (e.g., which alarms are active, audio options, etc.). This dialog box (and all the other dialog boxes described below) may be configured to disappear or be removed from the GUI **200** if there is no activity in the GUI for a certain period of time (e.g., 5 seconds). Controls available from the Alarm dialog box may include radio buttons, softkeys or other equivalent means for controlling various alarms related to conditions such as patient temperature, mattress temperature, oxygen levels, humidity levels, etc. The Alarm dialog box may also permit the disabling of all alarms, the display of all current alarms and alarm levels, the display of historical alarms and alarm levels and alarm volume controls.

**[0044]** If the caregiver selects the Therapy Settings icon **261**, a separate dialog box or window is displayed (not shown) which allows the caregiver to manipulate the therapy settings (e.g., mattress heating, heated air circulation, resuscitation settings, etc.). Controls available from the Therapy Settings dialog box may include radio buttons, softkeys or other equivalent means for controlling temperature, air flow and humidity within the warming therapy device, mattress temperature, radiant heater temperature, oxygen levels, resuscitation processes, and nCPAP processes. The Therapy Settings dialog box may also permit the enabling or disabling of a Kangaroo Mode®, wherein a parent or caregiver removes the medical patient from the warming therapy device but remains in close proximity.

**[0045]** If the caregiver selects the Trends/Review icon **262**, a separate dialog box or window is displayed (not shown) which allows the caregiver to manipulate the trends and review settings (e.g., select trends to monitor, display trends, display current values, etc.). Controls available from the Trends/Review dialog box may include radio buttons, softkeys or other equivalent means for displaying various trends.

**[0046]** If the caregiver selects the Procedures icon **263**, a separate dialog box or window is displayed (not shown) which allows the caregiver to manipulate the procedures settings (e.g., weight measurements, phototherapy procedures, etc.). Controls available from the Procedures dialog box may include radio buttons, softkeys or other equivalent means for performing various procedures such as weighing, the patient, performing phototherapy on the patient (to reduce or eliminate bilirubin), and performing audio stimulation (e.g., playing music or soothing sounds for the patient). The Procedures dialog box may also permit the setting of various timers for the above-referenced procedures.

**[0047]** If the caregiver selects the System Setup icon **264**, a separate dialog box or window is displayed (not shown) which allows the caregiver to manipulate the system settings (e.g., screen settings, trend settings, view settings, color settings, alarm settings, etc.). Controls available from the System Setup dialog box may include radio buttons, softkeys or other equivalent means for controlling current date and time, language, display brightness, display and editing of patient demographic information, enabling or disabling APGAR displays and controls, setting of units of measurement (e.g., ounces, pounds, kilograms, etc.), enabling or disabling locking of the touch screen, and enabling or disabling tilt and height adjustment controls. The System Setup dialog box may also permit control of trend default levels (e.g., for display in the Trends/Review dialog box), default views (e.g., for display in the View dialog box), default alarms and levels (e.g., for display in the Alarm dialog box), and default therapies and levels (e.g., for display in the Therapy Settings dialog box). The System Setup dialog box may also permit the assignment of various colors to different parameters, to make on-screen identification easier. For example, the caregiver may assign the color red to a patient temperature display, and the color blue to an oxygen level display. The System Setup dialog box may also permit the saving of data to an external data storage medium (e.g., Universal Serial Bus (USB) Drive, or the like), and the loading of data from an external data storage medium. The System Setup dialog box may also permit calibration of the oxygen sensors.

**[0048]** If the caregiver selects the View icon **265**, the view setting is changed. Each time the user select the View icon **265**, the view setting is changed as between three (3) different views. These views may comprise: (1) a Portrait View (7.2-8.4 inches wide by 9.6-11.2 inches high), (2) a Landscape View (9.6-11.2 inches wide by 7.2-8.4 inches high), and (3) a Split Screen View (two screens side by side with each being 4.5 inches wide by 3.25 inches high). In this manner, the caregiver can selection the View icon **265** multiple times to cycle through the various view settings. The Split Screen View allows the caregiver to display the main display portion **207** (described below), along with a resuscitation display portion **350**, discussed below (See FIG. 3). It will be noted that the various available views may be set initially by a manufacturer or hospital administrator, thus eliminating the need for the caregiver to configure the display prior to operation.

**[0049]** If the caregiver selects the Work Light icon **266**, the work light (not shown) associated with the warming therapy device **100** is switched 'on' and 'off.' For example, if the work light is 'on' when the caregiver selects the Work Light icon **266**, the light will be turned 'off.' Similarly, if the work light is 'off' when the caregiver selects the Work Light icon **266**, the light will be turned 'on.'

**[0050]** If the caregiver selects the Night Light icon **267**, the night light (not shown) associated with the warming therapy device **100** is switched 'on' and 'off.' For example, if the night light is 'on' when the caregiver selects the Night Light icon **266**, the light will be turned 'off.' Similarly, if the night light is 'off' when the caregiver selects the Night Light icon **266**, the light will be turned 'on.'

**[0051]** If the caregiver selects the Bed Adjustment icon **268**, a separate dialog box or window is displayed (not shown) which allows the caregiver to manipulate the configuration

settings for the warming therapy device (e.g., change the height of the mattress tray assembly 140, tilt the mattress tray assembly, etc.).

[0052] If the caregiver selects the Screen lock icon 269, the screen lock for the GUI 200 is switched 'on' and 'off.' For example, if the screen lock is 'on' when the caregiver selects the Screen Lock icon 269, the lock will be turned 'off.' Similarly, if the screen lock is 'off' when the caregiver selects the Screen lock icon 269, the lock will be turned 'on.' A graphical indicator (a lock with an open or closed clasp in FIG. 2) shows whether the screen is in the 'locked' or 'unlocked' state. When the screen lock is 'on' all controls on the GUI 200 (except the Screen Lock icon 269, as well as any other vital radio buttons, displays or icons) are either hidden or disabled.

[0053] The GUI 200 also includes a main display portion 207 which includes various displays and radio buttons. For example, the main display portion 207 includes a patient monitoring portion 270 which can display information such as: (1) oxygen levels, (2) patient temperature, (3) air temperature, (4) humidity, and (5) mattress temperature. The patient monitoring portion 270 is preferably laid out in a circular or oval pattern as shown in FIG. 2, where various gauges form the periphery of the circle or oval. The gauges around the periphery of the oval pattern show graphical representations of various values, such as air temperature (upper middle), mattress temperature (lower middle), humidity (right side) and oxygen level (left side). Next to each gauge is a numeric representation of the corresponding value. At the center of the oval pattern is a depiction of an infant patient 271, as well as one or more indicators 272 related to one or more probes coupled to the patient (e.g., Skin 1, Skin 2). The references "Skin 1" and "Skin 2" on the patient monitoring portion 270 correspond to probes which are coupled to the skin of the patient to measure temperature. In the exemplary GUI 200 shown in FIG. 2, the skin temperature reading for both probes is 36.5° C. (97.7° F.). Although the temperature reading is shown in FIG. 2 as being in Celsius, the caregiver can configure the format of the temperature displayed by the GUI 200 to Fahrenheit, Kelvin, or any other suitable measure. Preferably, the "Skin 1" probe is the primary temperature probe for the patient, and the indicator 272 associated therewith will read zero (0) if the associated probe is not coupled to the patient's skin. The "Skin 2" probe is a secondary probe that may be selectively displayed on the GUI 200. For example, if the probe associated with the "Skin 2" reference is not coupled to the patient, the "Skin 2" reference may not be displayed on the GUI 200.

[0054] The main display portion 207 also includes an air temperature portion 273 which includes "On" and "Off" radio buttons for selectively circulating heated air under the hood 145. The air temperature portion 273 also includes a radio button (e.g., "Set 33.0") for setting the temperature of the circulated air, and a display showing the actual temperature of the air inside the hood 145. As shown in FIG. 2, the air temperature has been set to a temperature of 33.0° C. (91.3° F.), and the actual temperature under the hood 145 is also 33.0° C. (91.3° F.). The air temperature may be measured by a temperature sensor, or equivalent means known in the art, which is coupled to the monitor 150. The air temperature portion 273 also includes a graphical indicator (represented by three wavy lines in FIG. 2) which indicates that air is currently being circulated.

[0055] The main display portion 207 also includes a mattress temperature portion 274 which includes a radio button

(e.g., "Set 36.5") for setting the temperature of a heated mattress, and a display showing the actual temperature at the mattress. As shown in FIG. 2, the mattress temperature has been set to a temperature of 36.5° C. (97.7° F.), and the actual temperature at the mattress is also 36.5° C. (97.7° F.). The mattress temperature may be measured by a temperature sensor, or equivalent means known in the art, which is coupled to the monitor 150. The mattress temperature portion 274 also includes a graphical indicator (represented by an oval with several wavy lines emanating upward therefrom in FIG. 2) which indicates that heated mattress is currently active.

[0056] The main display portion 207 also includes an oxygen level portion 275 which includes a radio button (e.g., "Set 21") for setting the oxygen level, and a display showing the actual oxygen level inside the hood 145. As shown in FIG. 2, the oxygen level has been set to a level of 21, and the actual oxygen level inside the hood 145 is also 21. The oxygen level inside the hood 145 may be measured by an oxygen sensor, or equivalent means known in the art, which is coupled to the monitor 150. The oxygen level portion 275 also includes a graphical indicator (represented by a leaf in FIG. 2) which indicates that oxygen is being supplied to the patient under the hood 145.

[0057] Finally, the main display portion 207 includes a humidity level portion 276 which includes a radio button (e.g., "Set 30") for setting the humidity level, and a display showing the actual humidity level inside the hood 145. As shown in FIG. 2, the humidity level has been set to a level of 30, and the actual humidity level inside the hood 145 is also 30. The humidity level inside the hood 145 may be measured by a humidity sensor, or equivalent means known in the art, which is coupled to the monitor 150. The humidity level portion 276 also includes a graphical indicator (represented by raindrops in FIG. 2) which indicates that the humidity control system is enabled.

[0058] The main display portion 207 of the GUI 200 also includes a heater power portion 280, a CPAP portion 290, a heart rate portion 300, and a resuscitation portion 310, which will be described below.

[0059] The heater power portion 280 includes a radio button in the shape of a thermometer with a (triangular) indicator along one side, and a display showing the heater power (e.g., 25%, 50%, 100%, etc.). The caregiver may touch the radio button to change the power level of the radiant heater head 120. For example, if the caregiver moves the triangular indicator halfway up the thermometer, the radiant heater head 120 will be at approximately 50% power. The heater power portion 280 also includes a graphical indicator (represented by an oval with several straight lines emanating therefrom in FIG. 2) which indicates that the radiant heater head 120 is enabled.

[0060] The CPAP portion 290 includes an "On/Off" radio button for selectively displaying a CPAP meter 291. The CPAP meter 291 displays the CPAP level and the PIP level, and may be used for monitoring airway pressure as is known in the art. The ability to display gauges, levels and values associated with CPAP processes on the GUI 200 substantially eliminates the need for one or more separate analog display gauges and meters, as is the case in many conventional warming therapy devices. This, in turn, allows a significant reduction in the overall space requirements for the devices.

[0061] The heart rate portion 300 includes an oxygen saturation (SpO<sub>2</sub>) display and a pulse display. The oxygen satu-

ration display shows the oxygen saturation of the patient's blood in percentage, and the pulse display shows the patient's pulse in beats per minute (bpm). The oxygen saturation and pulse levels of the patient may be measured by either or both of the "Skin 1" and "Skin 2" probes discussed above, or by other means known to those of ordinary skill in the art. The heart rate portion 300 also includes a graphical indicator (represented by a heart in FIG. 2) which indicates that the pulse and oxygenation levels of the patient are presently being monitored.

[0062] The resuscitation portion 310 is minimized in FIG. 2, and thus no information is shown. Additional information can be shown if the caregiver selects the "Resuscitation" radio button in the resuscitation portion 310, and expands the resuscitation portion. FIG. 3 shows the resuscitation portion 310 expanded, and further details thereon are discussed below.

[0063] FIG. 3 shows an alternative view of the GUI 200 which will be referenced as GUI 200'. In particular, FIG. 3 shows the Split Screen View discussed above. The GUI 200' includes many of the same elements as the GUI 200, and like reference numerals denote like elements. One difference is that the main display portion 207' is about half the size of the main display portion 207 shown in FIG. 2, which results in the patient monitoring portion 270' being more circular than oval. The other difference is the presence of the resuscitation portion 310' as part of the main display portion 207'. In particular, the resuscitation portion 310' has been expanded from the minimized position shown in FIG. 2. This may be accomplished by the caregiver touching the resuscitation portion 310 shown in FIG. 2. The resuscitation portion 310' may be minimized again (to the position shown in FIG. 2) by selecting of the 'minus' radio button 311' (the "-" button in FIG. 3). Another difference is that the CPAP portion 290 of the main display portion 207 is not shown in the main display portion 207' shown in FIG. 3. This is because the CPAP portion is alternatively displayed in the resuscitation portion 310', and thus the CPAP portion "On/Off" radio button has been switched to the "Off" position by default.

[0064] The resuscitation portion 310' includes a tank pressure display 312', a wall pressure display 313', a FiO2 display 314', and a flow display 315'. The resuscitation portion 310' also includes a suction "On/Off" radio button 316', and a flow "On/Off" radio button 317'. The resuscitation portion 310' also includes a CPAP meter 318' and a blood pressure meter 319'. The tank pressure display 312' displays the pressure for one or more gas tanks (e.g., Air and Oxygen) in kilopascals (kPa). The wall pressure display 313' displays the wall pressure for one or more gas tanks (e.g., Air and Oxygen) in kilopascals (kPa). The FiO2 display 314' displays the FiO2 concentration as a percentage (e.g., 40% as shown in FIG. 3). The flow display 315' displays the gas flow rate in liters per minute (lpm). As noted above with regard to the CPAP portion 290, the ability to display gauges, levels and values associated with resuscitation processes on the GUI 200' substantially eliminates the need for one or more separate analog display gauges and meters, as is the case in many conventional warming therapy devices. This, in turn, allows a significant reduction in the overall space requirements for the devices.

[0065] FIG. 4 shows a Graphical User Interface (GUI) 400 according to a second exemplary embodiment of the present invention which may be displayed on the monitor 150 discussed above. The GUI 400 is similar to the GUI 200 discussed above, and like reference numerals denote like elements. In the second exemplary embodiment, the GUI 400

comprises a 'touch screen' (as is known in the art) which is capable of receiving input from a user (e.g., caregiver) by the user touching various portions of a monitor (e.g., monitor 150) associated with the GUI.

[0066] The GUI 400 includes a patient information portion 401, which can display various personal information associated with the patient, such as name, weight, sex, and age. Although not shown, the patient information portion 401 can also display the current date and time for reference purposes, and a battery level indicator.

[0067] The GUI 400 also includes a main menu portion 406 for allowing the caregiver to perform various functions. The main menu portion 406 includes an Alarm icon 460, a Therapy Settings icon 461, a Trends/Review icon 462, a Procedures icon 463, a System Setup icon 464, a Timer icon 465 (that allows a user to configure a general purpose timer), a Bed Adjustment icon 468, and a Patient Profile icon 466 (that allows a user to enter Admit, Discharge and/or Transfer information pertaining to the patient). Although not shown in FIG. 4, the main menu portion 206 may include additional icons for performing additional functions, such as, a Hood icon for opening and closing the hood 145, a Tilt icon for tilting the mattress tray assembly 140, and a Help icon for accessing help information for the GUI.

[0068] If the caregiver selects the Alarm icon 460, a separate dialog box or window is displayed (not shown) which allows the caregiver to manipulate the alarm settings (e.g., which alarms are active, audio options, etc.). This dialog box (and all the other dialog boxes described below) may be configured to disappear or be removed from the GUI 200 if there is no activity in the GUI for a certain period of time (e.g., 5 seconds). Controls available from the Alarm dialog box may include radio buttons, softkeys or other equivalent means for controlling various alarms related to conditions such as patient temperature, mattress temperature, oxygen levels, humidity levels, etc. The Alarm dialog box may also permit the disabling of all alarms, the display of all current alarms and alarm levels, the display of historical alarms and alarm levels and alarm volume controls.

[0069] If the caregiver selects the Therapy Settings icon 461, a separate dialog box or window is displayed (not shown) which allows the caregiver to manipulate the therapy settings (e.g., mattress heating, heated air circulation, resuscitation settings, etc.). Controls available from the Therapy Settings dialog box may include radio buttons, softkeys or other equivalent means for controlling temperature, air flow and humidity within the warming therapy device, mattress temperature, radiant heater temperature, oxygen levels, resuscitation processes, and nCPAP processes. The Therapy Settings dialog box may also permit the enabling or disabling of a Kangaroo Mode®, wherein a parent or caregiver removes the medical patient from the warming therapy device but remains in close proximity.

[0070] If the caregiver selects the Trends/Review icon 462, a separate dialog box or window is displayed (not shown) which allows the caregiver to manipulate the trends and review settings (e.g., select trends to monitor, display trends, display current values, etc.). Controls available from the Trends/Review dialog box may include radio buttons, softkeys or other equivalent means for displaying various trends.

[0071] If the caregiver selects the Procedures icon 463, a separate dialog box or window is displayed (not shown) which allows the caregiver to manipulate the procedures settings (e.g., weight measurements, phototherapy procedures,

etc.). Controls available from the Procedures dialog box may include radio buttons, softkeys or other equivalent means for performing various procedures such as weighing the patient, performing phototherapy on the patient (to reduce or eliminate bilirubin), and performing audio stimulation (e.g., playing music or soothing sounds for the patient). The Procedures dialog box may also permit the setting of various timers for the above-referenced procedures.

**[0072]** If the caregiver selects the System Setup icon **464**, a separate dialog box or window is displayed (not shown) which allows the caregiver to manipulate the system settings (e.g., screen settings, trend settings, view settings, color settings, alarm settings, etc.). Controls available from the System Setup dialog box may include radio buttons, softkeys or other equivalent means for controlling current date and time, language, display brightness, display and editing of patient demographic information, enabling or disabling APGAR displays and controls, setting of units of measurement (e.g., ounces, pounds, kilograms, etc.), enabling or disabling locking of the touch screen, and enabling or disabling tilt and height adjustment controls. The System Setup dialog box may also permit control of trend default levels (e.g., for display in the Trends/Review dialog box), default views (e.g., for display in the View dialog box), default alarms and levels (e.g., for display in the Alarm dialog box), and default therapies and levels (e.g., for display in the Therapy Settings dialog box). The System Setup dialog box may also permit the assignment of various colors to different parameters, to make on-screen identification easier. For example, the caregiver may assign the color red to a patient temperature display, and the color blue to an oxygen level display. The System Setup dialog box may also permit the saving of data to an external data storage medium (e.g., Universal Serial Bus (USB) Drive, or the like), and the loading of data from an external data storage medium. The System Setup dialog box may also permit calibration of the oxygen sensors.

**[0073]** If the caregiver selects the Timer icon **465**, a separate dialog box or window is displayed (not shown) which allows the caregiver to configure and engage a general purpose timer. Controls available from the System Setup dialog box may include radio buttons, softkeys or other equivalent means for entering a start time for the countdown timer, starting the timer, and stopping the timer. For various applications, such as 'Kangaroo Care' (i.e., wherein a parent or caregiver removes the medical patient from the warming therapy device but remains in close proximity), APGAR assessment, resuscitation, feeding, etc. it is necessary to closely monitor the time when the activity was started. Depending on the user's preference, the timer may comprise a countdown timer or a timer starting at zero (0) and counting up.

**[0074]** If the caregiver selects the Patient Profile icon **466**, a separate dialog box or window is displayed (not shown) which allows the caregiver to enter Admit, Discharge and/or Transfer information pertaining to the patient. Controls available from the System Setup dialog box may include radio buttons, softkeys or other equivalent means for entering patient name, age, gender, race, birth date, etc.

**[0075]** If the caregiver selects the Bed Adjustment icon **468**, a separate dialog box or window is displayed (not shown) which allows the caregiver to manipulate the configuration settings for the warming therapy device (e.g., change the height of the mattress tray assembly **140**, tilt the mattress tray assembly, etc.). Controls available from the System Setup

dialog box may include radio buttons, softkeys or other equivalent means for adjusting bed height and tilt, and adjusting hood height and tilt.

**[0076]** The GUI **400** also includes a main display portion **407** which includes various displays and radio buttons. For example, the main display portion **407** includes a patient monitoring portion **470** which can display information such as: (1) oxygen levels, (2) patient temperature, (3) air temperature, (4) humidity, and (5) mattress temperature. The patient monitoring portion **470** is preferably laid out in a circular or oval pattern as shown in FIG. 4, where various gauges form the periphery of the circle or oval. The gauges around the periphery of the oval pattern show graphical representations of various values, such as air temperature (upper middle), mattress temperature (lower middle), humidity (right side) and oxygen level (left side). Next to each gauge is a numeric representation of the corresponding value. At the center of the oval pattern is a depiction of an infant patient **471**, as well as one or more patient temperature indicators **472**. The temperature indicators **472** indicate the temperature at different portions of the patient, such as for example, the torso and the feet. In the exemplary GUI **400** shown in FIG. 4, the temperature reading for the torso region is 37.2° C. (98.96° F.), and the temperature reading for the feet region is 36.0° C. (96.8° F.). Although the temperature reading is shown in FIG. 4 as being in Celsius, the caregiver can configure the format of the temperature displayed by the GUI **400** to Fahrenheit, Kelvin, or any other suitable measure.

**[0077]** The main display portion **407** also includes an air temperature portion **473** which includes a display showing the actual temperature of the air inside the hood of the warming therapy device (e.g., hood **145** in device **100** shown in FIG. 1). The air temperature may be measured by a temperature sensor, or equivalent means known in the art, which is coupled to the monitor **150**. The air temperature portion **473** may also include a graphical indicator (represented by fan blades in FIG. 4) which indicates whether air is currently being circulated.

**[0078]** The main display portion **407** also includes a mattress temperature portion **474** which includes a display showing the actual temperature at the mattress (e.g., mattress **111** in FIG. 1). As shown in FIG. 4, the actual temperature at the mattress is 36.5° C. (97.7° F.). The mattress temperature may be measured by a temperature sensor, or equivalent means known in the art, which is coupled to the monitor **150**. The mattress temperature portion **474** may also include a graphical indicator (represented by a rectangle with several wavy lines emanating upward therefrom in FIG. 4) which indicates whether heating of the mattress is currently occurring.

**[0079]** The main display portion **407** also includes an oxygen level portion **475** which includes a display showing the actual oxygen level inside the warming therapy device (e.g., hood **145** in device **100** shown in FIG. 1). As shown in FIG. 4, the measured oxygen level is 30%. The oxygen level may be measured by an oxygen sensor, or equivalent means known in the art, which is coupled to the monitor **150**. The oxygen level portion **475** may also include a graphical indicator (not shown) which indicates that oxygen is being supplied to the patient.

**[0080]** Finally, the main display portion **407** includes a humidity level portion **476** which includes a display showing the actual humidity level inside the warming therapy device (e.g., hood **145** in device **100** shown in FIG. 1). As shown in FIG. 4, the measured humidity level is 80%. The humidity

level may be measured by a humidity sensor, or equivalent means known in the art, which is coupled to the monitor 150. The humidity level portion 476 may also include a graphical indicator (represented by raindrops in FIG. 4) which indicates that the humidity control system is enabled. The humidity level portion 476 of the main display portion 407 may also include a radio button, softkey or other equivalent means for selecting a "Condensation Management" or "Anti-Rainout" protocol. When the protocol is engaged or 'on' (as shown in FIG. 4), the humidity within the hood is controlled so as to substantially prevent condensation from forming. For example, when the humidity level is set at high levels, such as ninety-five percent (95%) relative humidity, there is a high likelihood (depending on the room temperature) that condensation inside the walls of the warming therapy device will be so intense that the infant patient inside the incubator cannot be seen from the outside. Additionally, high humidity levels and interior condensation 'swamp' the inside of the warming therapy device, and increase the risk of infection. The protocol operates to substantially prevent such an occurrence.

[0081] The main display portion 407 of the GUI 400 also includes a volume control portion 480, a nCPAP portion 490, a heart rate portion 500, a resuscitation portion 510, and a phototherapy portion 520, which will be described below.

[0082] The volume control portion 480 includes a display showing the current volume level (e.g., 24). The caregiver may touch the volume control portion to change the volume level, or mute the volume level. For example, the caregiver may slide their finger across the volume control portion 480 from left to right to raise the volume level, and from right to left to lower the volume level. The volume control portion 480 also includes a graphical indicator (represented by a speaker with sound waves emanating therefrom in FIG. 4) which indicates whether sound is enabled. If sound is not enabled (or if sound has been muted), this graphical indicator may take the form of a speaker with a line through it, as is well known in the art.

[0083] The nCPAP portion 490 includes a radio button for selectively displaying additional nCPAP information. For example, selection of the radio button may expand the nCPAP portion 490, and correspondingly minimize other portions of the GUI 400, as shown in FIGS. 5 and 6. Further details of the nCPAP portion 490 are provided below.

[0084] The heart rate portion 500 includes an oxygen saturation (SpO<sub>2</sub>) display and a pulse display. The oxygen saturation display shows the oxygen saturation of the patient's blood in percentage, and the pulse display shows the patient's pulse in beats per minute (bpm). The oxygen saturation and pulse levels of the patient may be measured by means known to those of ordinary skill in the art. The heart rate portion 500 also includes a graphical indicator (represented by a heart in FIG. 4) which indicates that the pulse and oxygenation levels of the patient are presently being monitored.

[0085] The resuscitation portion 510 includes a radio button for selectively displaying additional resuscitation information. For example, selection of the radio button may expand the resuscitation portion 510, and correspondingly minimize other portions of the GUI 400, as shown in FIGS. 7 and 8. Further details of the resuscitation portion 510 are provided below.

[0086] The phototherapy portion 520 includes a radio button for selectively displaying additional phototherapy information. For example, selection of the radio button may expand the phototherapy portion 520, and correspondingly minimize other portions of the GUI 400 (not shown, but

similar to the displays shown in FIGS. 5-8). Further details of the phototherapy portion 520 are provided below.

[0087] FIG. 5 shows a first alternative view of the GUI 400 which will be referenced as GUI 400'. The GUI 400' includes many of the same elements as the GUI 400, and like reference numerals denote like elements. One difference is that the main display portion 407' is about half the size of the main display portion 407 shown in FIG. 4. The other difference is the enlarged nCPAP portion 490'. As noted above, enlargement of the nCPAP portion 490' may be accomplished by the caregiver touching the nCPAP portion 490 shown in FIG. 4. The nCPAP portion 490' may be minimized again (to the position shown in FIG. 4) by selection of the 'X' radio button 491' in FIG. 5. When enlarged as shown in FIG. 5, the nCPAP portion 490' includes wall oxygen and air supply pressure monitors 492', tank oxygen and air supply pressure monitors 493'. The nCPAP portion 490' also includes a FiO<sub>2</sub> portion 494', a flow portion 495', and a pressure portion 496'. Also shown is a CPAP level indicator 497', and a 'Stop CPAP' radio button 498'. The FiO<sub>2</sub> portion 494' allows the user to adjust the FiO<sub>2</sub> set point, the flow portion 495' allows the user to adjust the flow set point, and the pressure portion 496' allows the user to adjust the pressure set point. Similarly, the CPAP level indicator 497' allows the user to adjust the CPAP set point, and the 'Stop CPAP' radio button 498' toggles CPAP between 'on' and 'off' states. The ability to display gauges, levels and values associated with CPAP processes on the GUI 400' substantially eliminates the need for one or more separate analog display gauges and meters, as is the case in many conventional warming therapy devices. This, in turn, allows a significant reduction in the overall space requirements for the devices.

[0088] FIG. 6 shows a second alternative view of the GUI 400 which will be referenced as GUI 400". The GUI 400" includes many of the same elements as the GUI 400, and like reference numerals denote like elements. One difference is that the main display portion 407" is slightly smaller than the main display portion 407 shown in FIG. 4. The other difference is the enlarged nCPAP portion 490". As noted above, enlargement of the nCPAP portion 490" may be accomplished by the caregiver touching the nCPAP portion 490 shown in FIG. 4. Tile version of the nCPAP portion 490" shown in FIG. 6 is displayed when nCPAP therapy is initiated in FIG. 5, and then nCPAP information is minimized by selecting the 'X' radio button shown in the upper right hand corner of the nCPAP portion 490' in FIG. 5.

[0089] FIG. 7 shows a third alternative view of the GUI 400 which will be referenced as GUI 400"". The GUI 400"" includes many of the same elements as the GUI 400, and like reference numerals denote like elements. One difference is that the main display portion 407"" is about half the size of the main display portion 407 shown in FIG. 4. The other difference is the enlarged resuscitation portion 510'. As noted above, enlargement of the resuscitation portion 510' may be accomplished by the caregiver touching the resuscitation portion 510 shown in FIG. 4. The resuscitation portion 510' may be minimized again (to the position shown in FIG. 4) by selection of the 'X' radio button 511' in FIG. 7. When enlarged as shown in FIG. 7, the resuscitation portion 510' includes wall oxygen and air monitors 512', tank oxygen and air monitors 513'. The resuscitation portion 510' also includes a FiO<sub>2</sub> portion 514', a flow portion 515', and a suction portion 516'. Also shown are resuscitation level indicators 517', a 'Start Resuscitation' radio button 518', and a 'View' radio

button **519'**. The FiO<sub>2</sub> portion **514'** allows the user to adjust the FiO<sub>2</sub> set point, the flow portion **515'** allows the user to adjust the flow set point, and the suction portion **516'** allows the user to toggle suction between 'on' and 'off' states. Similarly, the PEEP and PIP resuscitation level indicators **517'** allow the user to adjust the PEEP and PIP set points, and the 'Start Resuscitation' radio button **518'** allows the user to toggle resuscitation between 'on' and 'off' states. The 'View' radio button **519'** permits the view shown on the GUI **400'** to be changed between different formats. As discussed above, exemplary views may include: (1) a Portrait View (7.2-8.4 inches wide by 9.6-11.2 inches high), (2) a Landscape View (9.6-11.2 inches wide by 7.2-8.4 inches high), and (3) a Split Screen View (two screens side by side with each being 4.5 inches wide by 3.25 inches high). The ability to display gauges, levels and values associated with resuscitation processes on the GUI **400''** substantially eliminates the need for one or more separate analog display gauges and meters, as is the case in many conventional warming therapy devices. This, in turn, allows a significant reduction in the overall space requirements for the devices.

[0090] FIG. 8 shows a fourth alternative view of the GUI **400'** which will be referenced as GUI **400'''**. The GUI **400'''** includes many of the same elements as the GUI **400'** and like reference numerals denote like elements. One difference between the GUI **400''** shown in FIG. 7 and the GUI **400'''** shown in FIG. 8 is the presence of a resuscitation display **520'**. As noted above, the resuscitation display **520'** may be presented to the caregiver when the caregiver selects the 'Start Resuscitation' radio button **518'** shown in FIG. 7. The resuscitation display **520'** may include a circular dial including visual indicators showing the PEEP and PIP levels displayed by the resuscitation level indicators **517'**.

[0091] Although exemplary embodiments of the present invention have been described above for use in procedures involving infants, those of ordinary skill in the art will realize that the exemplary embodiments of the present invention may be used for other types of operations and procedures, including for children and adults.

[0092] Although the invention has been described in terms of exemplary embodiments, it is not limited thereto. Rather, the appended claims should be construed broadly to include other variants and embodiments of the invention which may be made by those skilled in the art without departing from the scope and range of equivalents of the invention. This disclosure is intended to cover any adaptations or variations of the embodiments discussed herein.

What is claimed is:

1. An apparatus comprising:
  - a warming therapy device; and
  - at least one monitor coupled to the warming therapy device for displaying information related to a medical patient, wherein said monitor operates to display at least one medical patient temperature level, and at least one resuscitation indicator on a single display screen.
2. The apparatus of claim 1, wherein the monitor operates to further display at least one oxygen level on the single display screen.
3. The apparatus of claim 1, wherein the monitor operates to further display at least one humidity level, at least one air circulation level, and at least one mattress temperature level on the single display screen.

4. The apparatus of claim 1, wherein the monitor operates to further display at least one CPAP indicator on the single display screen.

5. The apparatus of claim 1, wherein the at least one resuscitation indicator may be expanded on the single screen to show detailed resuscitation information.

6. The apparatus of claim 1, wherein the at least one CPAP indicator may be expanded on the single screen to show detailed CPAP information.

7. The apparatus of claim 1, wherein the at least one monitor is removably coupled to the warming therapy device.

8. A touch screen apparatus comprising:

- a first display portion for displaying a first set of information related to a medical patient;
- a second display portion for displaying menu information; and,
- a third display portion for displaying a second set of information related to a medical patient.

9. The touch screen apparatus of claim 8, wherein the first display portion displays medical patient name information.

10. The touch screen apparatus of claim 8, wherein the second display portion displays medical patient temperature information.

11. The touch screen apparatus of claim 8, wherein the second display portion displays oxygen level information.

12. The touch screen apparatus of claim 8, wherein the second display portion displays humidity information.

13. The touch screen apparatus of claim 8, further comprising a fourth display portion for displaying CPAP information.

14. The touch screen apparatus of claim 8, further comprising a fourth display portion for displaying resuscitation information.

15. The touch screen apparatus of claim 8, wherein the third display portion comprises a first information portion comprising a substantially circular display, and a second information portion comprising an image representative of a medical patient, wherein the second information portion is disposed substantially centrally within the first information portion.

16. The touch screen apparatus of claim 15, wherein the first information portion displays at least one oxygen level, at least one humidity level, at least one air circulation level, and at least one mattress temperature level.

17. A method for monitoring a medical patient, the method comprising:

- displaying a first set of information related to a medical patient on a first portion of a computer monitor;
- displaying menu information on a second portion of a computer monitor; and,
- displaying a second set of information related to a medical patient on a third portion of a computer monitor.

18. The method of claim 17, wherein the step of displaying a first set of information related to a medical patient on a first portion of a computer monitor comprises displaying medical patient name information.

19. The method of claim 17, wherein the step of displaying a second set of information related to a medical patient on a third portion of a computer monitor comprises displaying medical patient temperature information.

20. A computer system comprising:

- at least one monitor;
- at least one processor; and,
- at least one memory coupled to the at least one processor;

wherein the at least one memory includes at least one program stored thereon, said at least one program being capable of performing the following steps:

displaying a first set of information related to a medical patient on a first portion of the at least one monitor;  
displaying menu information on a second portion of the at least one monitor; and,  
displaying a second set of information related to a medical patient on a third portion of the at least one monitor.

**21.** The computer system of claim **20**, wherein the step of displaying a second set of information related to a medical patient comprises displaying one or more type of information selected from the group consisting of: CPAP information, resuscitation information, heart rate information, patient temperature information, mattress temperature information, oxygen level information and humidity level information.

**22.** A computer readable medium having embodied therein a computer program for processing by a machine, the computer program comprising:

a first code segment for displaying a first set of information related to a medical patient on a first portion of a computer monitor;  
a second code segment for displaying menu information on a second portion of the computer monitor; and,  
a third code segment for displaying a second set of information related to a medical patient on a third portion of the computer monitor.

**23.** A computer monitor apparatus comprising:

a first display portion for displaying an image representative of a medical patient;  
a second display portion for displaying a first set of information related to a medical patient, wherein the second display portion comprises a substantially circular display which substantially surrounds the first display portion.

**24.** The computer monitor apparatus of claim **23**, wherein the second display portion displays air circulation informa-

tion, humidity information, mattress temperature information and oxygen level information.

**25.** The computer monitor apparatus of claim **24**, wherein the second display portion displays at least one gauge associated with each of the air circulation information, humidity information, mattress temperature information and oxygen level information.

**26.** The computer monitor apparatus of claim **23**, further comprising:

a third display portion for displaying menu information; and,  
a fourth display portion for displaying a second set of information related to the medical patient.

**27.** An apparatus comprising:

a warming therapy device; and,  
at least one monitor coupled to the warming therapy device for displaying information related to a medical patient, wherein said monitor operates to display at least one medical patient temperature level, and at least one CPAP indicator on a single display screen.

**28.** A control system for a warming therapy device comprising:

at least one monitor; and,  
at least one processor coupled to the at least one monitor, wherein the at least one processor includes at least one first output for transmitting medical information relating to a medical patient to the at least one monitor, said medical information being displayed on a first portion of the monitor, and

wherein the at least one processor includes at least one second output for transmitting resuscitation information relating to a medical patient to the at least one monitor, said resuscitation information being displayed on a second portion of the monitor.

\* \* \* \* \*

专利名称(译)	用于控制加温治疗装置的方法和设备		
公开(公告)号	<a href="#">US20090149927A1</a>	公开(公告)日	2009-06-11
申请号	US12/271225	申请日	2008-11-14
[标]申请(专利权)人(译)	德雷格医疗系统股份有限公司		
申请(专利权)人(译)	德尔格医疗系统公司.		
当前申请(专利权)人(译)	德尔格医疗系统公司.		
[标]发明人	KNEUER HARALD WALOSCHEK THORSTEN MEDICO PETER RICHARDS JOHN POGGENSEE INES FILES NANCY MOEHRING PHILIP		
发明人	KNEUER, HARALD WALOSCHEK, THORSTEN MEDICO, PETER RICHARDS, JOHN POGGENSEE, INES FILES, NANCY MOEHRING, PHILIP		
IPC分类号	A61F7/00 A61B5/01 A61B5/00 G06F3/041		
CPC分类号	A61B5/01 A61G2203/46 A61B5/145 A61B19/56 A61F7/00 A61F2007/0095 A61F2007/0096 A61G11/00 G05D23/00 G06F3/0484 A61B5/7445 A61H31/00 A61M16/0057 A61G11/008 A61G11/002 A61B5/0205 A61B34/25		
优先权	61/005510 2007-12-05 US		
其他公开文献	US8442843		
外部链接	<a href="#">Espacenet</a> <a href="#">USPTO</a>		

摘要(译)

描述了一种用于控制加热治疗装置（例如，培养箱，加热器等）的装置和方法。在一个示例性实施例中，该装置包括耦合到加温治疗设备的图形用户交错（GUI），用于监控患者医疗信息，并相应地控制加温治疗设备的各个方面。

