



US009532724B2

(12) **United States Patent**
Grunwald

(10) **Patent No.:** **US 9,532,724 B2**
(45) **Date of Patent:** **Jan. 3, 2017**

(54) **APPARATUS AND METHOD FOR CATHETER NAVIGATION USING ENDOVASCULAR ENERGY MAPPING**

(75) Inventor: **Sorin Grunwald**, Paris (FR)
(73) Assignee: **Bard Access Systems, Inc.**, Salt Lake City, UT (US)

(*) Notice: Subject to any disclaimer, the term of this patent is extended or adjusted under 35 U.S.C. 154(b) by 970 days.

(21) Appl. No.: **13/240,171**

(22) Filed: **Sep. 22, 2011**

(65) **Prior Publication Data**
US 2012/0059270 A1 Mar. 8, 2012

Related U.S. Application Data
(63) Continuation-in-part of application No. 13/019,939, filed on Feb. 2, 2011, now Pat. No. 9,125,578, which is
(Continued)

(51) **Int. Cl.**
A61B 5/04 (2006.01)
A61B 5/00 (2006.01)
(Continued)

(52) **U.S. Cl.**
CPC **A61B 5/04017** (2013.01); **A61B 5/0006** (2013.01); **A61B 5/042** (2013.01);
(Continued)

(58) **Field of Classification Search**
CPC ... A61B 5/0006; A61B 5/04017; A61B 5/042; A61B 5/0452; A61B 5/06; A61B 5/061; A61B 5/065; A61B 5/066
(Continued)

(56) **References Cited**

U.S. PATENT DOCUMENTS

3,133,244 A 5/1964 Wojtulewicz
3,297,020 A 1/1967 Mathiesen
(Continued)

FOREIGN PATENT DOCUMENTS

AU 642647 11/1990
AU 1860597 B2 6/1999
(Continued)

OTHER PUBLICATIONS

U.S. Appl. No. 12/893,916, filed Sep. 29, 2010 Non-Final Office Action dated Sep. 25, 2014.

(Continued)

Primary Examiner — Tammie K Heller

(74) *Attorney, Agent, or Firm* — Rutan & Tucker, LLP

(57) **ABSTRACT**

Devices and methods obtain and use endovascular electrograms in a number of clinical applications and settings. In one embodiment, a method for locating an indwelling medical device within a vasculature of a patient includes identifying an endovascular ECG waveform complex from an endovascular ECG signal associated with the indwelling medical device, then calculating an absolute value of the energy of the endovascular ECG waveform complex over a predetermined segment thereof. A position of the medical device within the vasculature is then determined by observation of the absolute value of the energy of the predetermined segment of the endovascular ECG waveform complex.

13 Claims, 46 Drawing Sheets

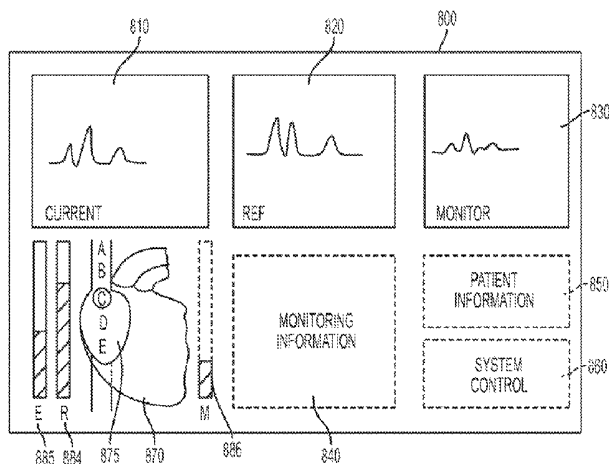

Related U.S. Application Data

a continuation-in-part of application No. 12/854,083, filed on Aug. 10, 2010, now Pat. No. 9,445,734, which is a continuation-in-part of application No. 12/815,331, filed on Jun. 14, 2010, now Pat. No. 9,339,206.

(60) Provisional application No. 61/344,732, filed on Sep. 23, 2010, provisional application No. 61/282,397, filed on Feb. 2, 2010, provisional application No. 61/272,025, filed on Aug. 10, 2009, provisional application No. 61/213,474, filed on Jun. 12, 2009.

(51) **Int. Cl.**

- A61B 5/042* (2006.01)
- A61B 5/0452* (2006.01)
- A61B 5/06* (2006.01)
- A61M 25/00* (2006.01)
- A61M 25/01* (2006.01)
- A61M 25/09* (2006.01)

(52) **U.S. Cl.**

- CPC *A61B 5/0452* (2013.01); *A61B 5/06* (2013.01); *A61B 5/7203* (2013.01); *A61B 2034/2046* (2016.02); *A61M 25/003* (2013.01); *A61M 25/0026* (2013.01); *A61M 25/0102* (2013.01); *A61M 25/0147* (2013.01); *A61M 25/0194* (2013.01); *A61M 2025/09116* (2013.01)

(58) **Field of Classification Search**

USPC 600/517, 521, 523
See application file for complete search history.

(56) **References Cited**

U.S. PATENT DOCUMENTS

3,625,200 A	12/1971	Muller	4,565,201 A	1/1986	Lass
3,674,014 A	7/1972	Tillander et al.	4,572,198 A	2/1986	Codrington
3,817,241 A	6/1974	Grausz	4,577,634 A	3/1986	Gessman
3,847,157 A	11/1974	Caillouette et al.	4,582,067 A	4/1986	Silverstein et al.
3,868,565 A	2/1975	Kuipers	4,587,975 A	5/1986	Salo et al.
3,896,373 A	7/1975	Zelby	4,588,394 A	5/1986	Schulte et al.
3,902,501 A	9/1975	Citron et al.	4,593,687 A	6/1986	Gray
3,986,373 A	10/1976	Goodlaxson	4,595,012 A	6/1986	Webler et al.
3,995,623 A	12/1976	Blake et al.	4,601,706 A	7/1986	Aillon
4,003,369 A	1/1977	Heilman et al.	4,608,989 A	9/1986	Drue
4,063,561 A	12/1977	McKenna	4,608,992 A	9/1986	Hakim et al.
4,072,146 A	2/1978	Howes	4,619,247 A	10/1986	Inoue et al.
4,114,601 A	9/1978	Abels	4,622,644 A	11/1986	Hansen
4,149,535 A	4/1979	Volder et al.	4,644,960 A	2/1987	Johans
4,173,228 A	11/1979	Steenwyk et al.	4,652,820 A	3/1987	Maresca
4,175,566 A	11/1979	Millar	4,660,571 A	4/1987	Hess et al.
4,181,120 A	1/1980	Kunii et al.	4,665,925 A	5/1987	Millar
4,224,949 A	9/1980	Scott et al.	4,667,230 A	5/1987	Arakawa et al.
4,244,362 A	1/1981	Anderson	4,674,518 A	6/1987	Salo
4,289,139 A	9/1981	Enjoji et al.	4,676,249 A	6/1987	Arenas et al.
4,317,078 A	2/1982	Weed et al.	4,681,106 A	7/1987	Kensey et al.
4,327,722 A	5/1982	Groshong et al.	4,681,117 A	7/1987	Brodman et al.
4,327,723 A	5/1982	Frankhouser	4,688,578 A	8/1987	Takano et al.
4,362,166 A	12/1982	Furler et al.	4,692,148 A	9/1987	Kantrowitz et al.
4,365,639 A	12/1982	Goldreyer	4,697,595 A	10/1987	Breyer et al.
4,380,237 A	4/1983	Newbower	4,700,997 A	10/1987	Strand
4,407,294 A	10/1983	Vilkomerson	4,706,681 A	11/1987	Breyer et al.
4,417,886 A	11/1983	Frankhouser et al.	4,710,708 A	12/1987	Rorden et al.
4,429,693 A	2/1984	Blake et al.	4,733,669 A	3/1988	Segal
4,431,005 A	2/1984	McCormick	4,737,794 A	4/1988	Jones
4,431,214 A	2/1984	Buffington	4,741,356 A	5/1988	Letzo et al.
4,445,501 A	5/1984	Bresler	4,742,356 A	5/1988	Kuipers
4,459,854 A	7/1984	Richardson et al.	4,753,247 A	6/1988	Kirsner et al.
4,469,106 A	9/1984	Harui	4,770,185 A	9/1988	Silverstein et al.
4,483,343 A	11/1984	Beyer et al.	4,771,788 A	9/1988	Millar
4,491,137 A	1/1985	Jingu	4,781,685 A	11/1988	Lehmann et al.
			4,784,646 A	11/1988	Feingold
			4,787,070 A	11/1988	Suzuki et al.
			4,787,396 A	11/1988	Pidorenko
			4,790,809 A	12/1988	Kuntz
			4,793,361 A	12/1988	DuFault
			4,794,930 A	1/1989	Machida et al.
			4,796,632 A	1/1989	Boyd et al.
			4,798,588 A	1/1989	Aillon
			4,798,598 A	1/1989	Bonello et al.
			4,809,681 A	3/1989	Kantrowitz et al.
			4,809,713 A	3/1989	Grayzel
			4,813,729 A	3/1989	Speckhart
			4,821,731 A	4/1989	Martinelli et al.
			4,836,214 A	6/1989	Sramek
			4,840,182 A	6/1989	Carlson
			4,840,622 A	6/1989	Hardy
			4,841,977 A	6/1989	Griffith et al.
			4,849,692 A	7/1989	Blood
			4,850,358 A	7/1989	Millar
			4,852,580 A	8/1989	Wood
			4,856,317 A	8/1989	Pidorenko et al.
			4,856,529 A	8/1989	Segal
			4,860,757 A	8/1989	Lynch et al.
			4,867,169 A	9/1989	Machida et al.
			4,869,263 A	9/1989	Segal et al.
			4,869,718 A	9/1989	Brader
			4,873,987 A	10/1989	Djordjevich et al.
			4,887,606 A	12/1989	Yock et al.
			4,887,615 A	12/1989	Taylor
			4,889,128 A	12/1989	Millar
			4,899,756 A	2/1990	Sonek
			4,901,725 A	2/1990	Nappholz et al.
			4,905,698 A	3/1990	Strohl, Jr. et al.
			4,911,173 A	3/1990	Terwilliger
			4,911,174 A	3/1990	Pederson et al.
			4,917,669 A	4/1990	Bonaldo
			4,924,870 A	5/1990	Wlodarczyk et al.
			4,943,770 A	7/1990	Ashley-Rollman et al.
			4,945,305 A	7/1990	Blood
			4,947,852 A	8/1990	Nassi et al.
			4,957,110 A	9/1990	Vogel et al.
			4,957,111 A	9/1990	Millar
			4,961,433 A	10/1990	Christian

(56)

References Cited

U.S. PATENT DOCUMENTS

4,966,148 A	10/1990	Millar	5,274,551 A	12/1993	Corby, Jr.
4,967,753 A	11/1990	Haase et al.	5,275,053 A	1/1994	Wlodarczyk et al.
4,977,886 A	12/1990	Takehana et al.	5,279,129 A	1/1994	Ito
4,989,608 A	2/1991	Ratner	5,279,607 A	1/1994	Schentag et al.
4,989,610 A	2/1991	Patton et al.	5,280,786 A	1/1994	Wlodarczyk et al.
4,995,396 A	2/1991	Inaba et al.	5,287,331 A	2/1994	Schindel et al.
4,998,916 A	3/1991	Hammerslag et al.	5,289,373 A	2/1994	Zarge et al.
5,004,456 A	4/1991	Botterbusch et al.	5,292,342 A	3/1994	Nelson et al.
5,005,592 A	4/1991	Cartmell	5,307,072 A	4/1994	Jones, Jr.
5,016,173 A	5/1991	Kenet et al.	5,311,871 A	5/1994	Yock
5,025,799 A	6/1991	Wilson	5,313,949 A	5/1994	Yock
5,029,585 A	7/1991	Lieber et al.	5,318,025 A	6/1994	Dumoulin et al.
5,040,548 A	8/1991	Yock	5,325,860 A	7/1994	Seward et al.
5,042,486 A	8/1991	Pfeiler et al.	5,325,873 A	7/1994	Hirschi et al.
5,045,071 A	9/1991	McCormick et al.	5,330,496 A	7/1994	Alferness
5,046,497 A	9/1991	Millar	5,331,966 A	7/1994	Bennett et al.
5,050,607 A	9/1991	Bradley et al.	5,333,614 A	8/1994	Feiring
5,057,095 A	10/1991	Fabian	5,337,678 A	8/1994	Grout et al.
5,058,583 A	10/1991	Geddes et al.	5,341,807 A	8/1994	Nardella
5,058,595 A	10/1991	Kern	5,343,865 A	9/1994	Gardineer et al.
5,067,489 A	11/1991	Lind	5,345,940 A	9/1994	Seward et al.
5,076,278 A	12/1991	Vilkomerson et al.	5,348,020 A	9/1994	Hutson
5,078,140 A	1/1992	Kwoh	5,350,352 A	9/1994	Buchholtz et al.
5,078,148 A	1/1992	Nassi et al.	5,357,961 A	10/1994	Fields et al.
5,078,149 A	1/1992	Katsumata et al.	5,365,935 A	11/1994	Righter et al.
5,078,678 A	1/1992	Katims	5,366,443 A	11/1994	Eggers et al.
5,078,714 A	1/1992	Katims	5,368,048 A	11/1994	Stoy et al.
5,084,022 A	1/1992	Claude	5,375,596 A	12/1994	Twiss et al.
5,092,341 A	3/1992	Kelen	5,376,083 A	12/1994	Mische
5,099,845 A	3/1992	Besz et al.	5,377,678 A	1/1995	Dumoulin et al.
5,099,850 A	3/1992	Matsui et al.	5,385,053 A	1/1995	Wlodarczyk et al.
5,100,387 A	3/1992	Ng	5,385,146 A	1/1995	Goldreyer
5,105,829 A	4/1992	Fabian et al.	5,391,199 A	2/1995	Ben-Haim
5,109,862 A	5/1992	Kelen et al.	5,394,876 A	3/1995	Ma
5,114,401 A	5/1992	Stuart et al.	5,394,877 A	3/1995	Orr et al.
5,121,750 A	6/1992	Katims	5,395,366 A	3/1995	D'Andrea et al.
5,125,410 A	6/1992	Misono et al.	5,398,683 A	3/1995	Edwards et al.
5,134,370 A	7/1992	Jefferts et al.	5,398,691 A	3/1995	Martin et al.
5,144,955 A	9/1992	O'Hara	5,411,485 A	5/1995	Tennican et al.
5,156,151 A	10/1992	Imran	5,413,107 A	5/1995	Oakley et al.
5,158,086 A	10/1992	Brown et al.	5,417,208 A	5/1995	Winkler
5,160,342 A	11/1992	Reger et al.	5,422,478 A	6/1995	Wlodarczyk et al.
5,161,536 A	11/1992	Vilkomerson et al.	5,423,334 A	6/1995	Jordan
5,174,295 A	12/1992	Christian et al.	5,423,877 A	6/1995	Mackey
5,174,299 A	12/1992	Nelson	5,425,367 A	6/1995	Shapiro et al.
5,184,601 A	2/1993	Putman	5,425,370 A	6/1995	Vilkomerson
5,190,045 A	3/1993	Frazin	5,425,382 A	6/1995	Golden et al.
5,202,985 A	4/1993	Goyal	5,427,114 A	6/1995	Colliver et al.
5,205,830 A	4/1993	Dassa et al.	5,429,132 A	7/1995	Guy et al.
5,211,165 A	5/1993	Dumoulin et al.	5,429,617 A	7/1995	Hammersmark et al.
5,211,636 A	5/1993	Mische	5,431,641 A	7/1995	Grozinger et al.
5,212,988 A	5/1993	White et al.	5,433,729 A	7/1995	Adams et al.
5,214,615 A	5/1993	Bauer et al.	5,437,276 A	8/1995	Takada et al.
5,217,026 A	6/1993	Stoy et al.	5,437,277 A	8/1995	Dumoulin et al.
5,220,924 A	6/1993	Frazin	5,438,873 A	8/1995	Wlodarczyk et al.
5,233,994 A	8/1993	Shmulewitz	5,443,066 A	8/1995	Dumoulin et al.
5,235,987 A	8/1993	Wolfe	5,443,489 A	8/1995	Ben-Haim
5,239,464 A	8/1993	Blair et al.	5,445,150 A	8/1995	Dumoulin et al.
5,240,004 A	8/1993	Walinsky et al.	5,445,166 A	8/1995	Taylor
5,243,995 A	9/1993	Maier	5,450,846 A	9/1995	Goldreyer
5,246,007 A	9/1993	Frisbie et al.	5,453,575 A	9/1995	O'Donnell et al.
5,246,426 A	9/1993	Lewis et al.	5,453,576 A	9/1995	Krivitski
5,247,171 A	9/1993	Wlodarczyk et al.	5,456,256 A	10/1995	Schneider
5,251,635 A	10/1993	Dumoulin et al.	5,456,718 A	10/1995	Szymaitis
5,255,680 A	10/1993	Darrow et al.	5,464,016 A	11/1995	Nicholas et al.
5,257,636 A	11/1993	White	5,474,065 A	12/1995	Meathrel et al.
5,257,979 A	11/1993	Jagpal	5,476,090 A	12/1995	Kishi
5,261,409 A	11/1993	Dardel	5,480,422 A	1/1996	Ben-Haim
5,265,610 A	11/1993	Darrow et al.	5,487,729 A	1/1996	Avellanet et al.
5,265,614 A	11/1993	Hayakawa et al.	5,490,522 A	2/1996	Dardel
5,267,569 A	12/1993	Lienhard	5,492,538 A	2/1996	Johlin, Jr.
5,270,810 A	12/1993	Nishimura	5,494,038 A	2/1996	Wang et al.
5,271,404 A	12/1993	Corl et al.	5,500,011 A	3/1996	Desai
5,273,025 A	12/1993	Sakiyama et al.	5,500,012 A	3/1996	Brucker et al.
5,273,042 A	12/1993	Lynch et al.	5,505,205 A	4/1996	Solomon et al.
			5,509,822 A	4/1996	Negus et al.
			5,513,637 A	5/1996	Twiss et al.
			5,515,160 A	5/1996	Schulz et al.
			5,515,853 A	5/1996	Smith et al.

(56)

References Cited

U.S. PATENT DOCUMENTS

5,517,989 A	5/1996	Frisbie et al.	5,733,323 A	3/1998	Buck et al.
5,522,878 A	6/1996	Montecalvo et al.	5,738,096 A	4/1998	Ben-Haim
5,522,880 A	6/1996	Barone et al.	5,740,808 A	4/1998	Panescu et al.
5,526,812 A	6/1996	Dumoulin et al.	5,742,394 A	4/1998	Hansen
5,531,664 A	7/1996	Adachi et al.	5,744,953 A	4/1998	Hansen
5,536,248 A	7/1996	Weaver et al.	5,748,767 A	5/1998	Raab
5,540,230 A	7/1996	Vilkomerson	5,749,835 A	5/1998	Glantz
5,540,681 A	7/1996	Strul et al.	5,749,938 A	5/1998	Coombs
5,542,938 A	8/1996	Avellanet et al.	5,751,785 A	5/1998	Moorman et al.
5,546,949 A	8/1996	Frazin et al.	5,752,513 A	5/1998	Acker et al.
5,546,951 A	8/1996	Ben-Haim	5,758,650 A	6/1998	Miller et al.
5,555,618 A	9/1996	Winkler	5,762,064 A	6/1998	Polvani
5,558,091 A	9/1996	Acker et al.	5,767,669 A	6/1998	Hansen et al.
5,568,809 A	10/1996	Ben-haim	5,767,960 A	6/1998	Orman et al.
D375,450 S	11/1996	Bidwell et al.	5,769,786 A	6/1998	Wiegel
5,570,671 A	11/1996	Hickey	5,769,843 A	6/1998	Abela et al.
5,575,291 A	11/1996	Hayakawa et al.	5,769,881 A	6/1998	Schroepffel et al.
5,588,442 A	12/1996	Scovil et al.	5,771,896 A	6/1998	Sliwa, Jr. et al.
5,592,939 A	1/1997	Martinelli	5,775,322 A	7/1998	Silverstein et al.
5,598,846 A	2/1997	Peszynski	5,775,332 A	7/1998	Goldman
5,599,299 A	2/1997	Weaver et al.	5,776,064 A	7/1998	Kalfas et al.
5,600,330 A	2/1997	Blood	5,776,080 A	7/1998	Thome et al.
5,603,333 A	2/1997	Konings	5,779,638 A	7/1998	Vesely et al.
5,610,967 A	3/1997	Moorman et al.	5,782,767 A	7/1998	Pretlow, III
5,617,866 A	4/1997	Marian, Jr.	5,782,773 A	7/1998	Kuo et al.
5,622,169 A	4/1997	Golden et al.	5,785,657 A	7/1998	Breyer et al.
5,622,170 A	4/1997	Schulz	5,792,055 A	8/1998	McKinnon et al.
5,622,184 A	4/1997	Ashby et al.	5,795,297 A	8/1998	Daigle
5,623,931 A	4/1997	Wung et al.	5,795,298 A	8/1998	Vesely et al.
5,624,430 A	4/1997	Eton et al.	5,795,632 A	8/1998	Buchalter
5,626,554 A	5/1997	Ryaby et al.	5,797,849 A	8/1998	Vesely et al.
5,626,870 A	5/1997	Monshipouri et al.	5,800,352 A	9/1998	Ferre et al.
5,630,419 A	5/1997	Ranalletta	5,800,410 A	9/1998	Gawreluk
5,638,819 A	6/1997	Manwaring et al.	5,800,497 A	9/1998	Bakels et al.
5,644,612 A	7/1997	Moorman et al.	5,803,089 A	9/1998	Ferre et al.
5,645,065 A	7/1997	Shapiro et al.	5,810,733 A	9/1998	Van Creveld et al.
5,651,047 A	7/1997	Moorman et al.	RE35,924 E	10/1998	Winkler
5,654,864 A	8/1997	Ritter et al.	5,817,022 A	10/1998	Vesely
D383,968 S	9/1997	Bidwell et al.	5,817,024 A	10/1998	Ogle et al.
5,662,115 A	9/1997	Torp et al.	5,820,549 A	10/1998	Marian, Jr.
5,665,103 A	9/1997	Lafontaine et al.	5,824,031 A	10/1998	Cookston et al.
5,665,477 A	9/1997	Meathrel et al.	5,827,192 A	10/1998	Gopakumaran et al.
5,666,473 A	9/1997	Wallace	5,829,444 A	11/1998	Ferre et al.
5,666,958 A	9/1997	Rothenberg et al.	5,830,145 A	11/1998	Tenhoff
5,669,383 A	9/1997	Johnson	5,831,260 A	11/1998	Hansen
5,669,388 A	9/1997	Vilkomerson	5,833,608 A	11/1998	Acker
5,676,159 A	10/1997	Navis	5,833,622 A	11/1998	Meathrel et al.
5,676,673 A	10/1997	Ferre et al.	5,835,561 A	11/1998	Moorman et al.
5,682,890 A	11/1997	Kormos et al.	5,836,882 A	11/1998	Frazin
5,691,898 A	11/1997	Rosenberg et al.	5,836,990 A	11/1998	Li
5,694,945 A	12/1997	Ben-Haim	5,840,024 A	11/1998	Taniguchi et al.
5,695,479 A	12/1997	Jagpal	5,840,025 A	11/1998	Ben-Haim
5,697,377 A	12/1997	Wittkampf	5,840,030 A	11/1998	Ferek-Petric et al.
5,699,801 A	12/1997	Atalar et al.	5,840,031 A	11/1998	Crowley
5,700,889 A	12/1997	Blair	5,842,986 A	12/1998	Avrin et al.
5,701,898 A	12/1997	Adam et al.	5,842,998 A	12/1998	Gopakumaran et al.
5,702,433 A	12/1997	Taylor et al.	5,843,076 A	12/1998	Webster, Jr. et al.
5,711,299 A	1/1998	Manwaring et al.	5,843,153 A	12/1998	Johnston et al.
5,713,362 A	2/1998	Vilkomerson	5,844,140 A	12/1998	Seale
5,713,363 A	2/1998	Seward et al.	5,846,198 A	12/1998	Killmann
5,713,858 A	2/1998	Heruth et al.	5,855,553 A	1/1999	Tajima et al.
5,713,946 A	2/1998	Ben-Haim	5,859,893 A	1/1999	Moorman et al.
5,715,817 A	2/1998	Stevens-Wright et al.	5,865,748 A	2/1999	Co et al.
5,716,389 A	2/1998	Walinsky et al.	5,868,673 A	2/1999	Vesely
5,718,241 A	2/1998	Ben-Haim et al.	5,873,822 A	2/1999	Ferre et al.
D391,838 S	3/1998	Bidwell et al.	5,876,328 A	3/1999	Fox et al.
5,722,412 A	3/1998	Pflugrath et al.	5,879,297 A	3/1999	Haynor et al.
5,727,550 A	3/1998	Montecalvo	5,893,363 A	4/1999	Little et al.
5,727,552 A	3/1998	Ryan	5,897,495 A	4/1999	Aida et al.
5,727,553 A	3/1998	Saad	5,899,860 A	5/1999	Pfeiffer et al.
5,729,055 A	3/1998	Manning	5,902,238 A	5/1999	Golden et al.
5,729,129 A	3/1998	Acker	5,907,487 A	5/1999	Rosenberg et al.
5,729,584 A	3/1998	Moorman et al.	5,908,385 A	6/1999	Chechelski et al.
5,730,129 A	3/1998	Darrow et al.	5,910,113 A	6/1999	Pruter
5,731,996 A	3/1998	Gilbert	5,910,120 A	6/1999	Kim et al.
			5,913,820 A	6/1999	Bladen et al.
			5,913,830 A	6/1999	Miles
			5,919,141 A	7/1999	Money et al.
			5,919,170 A	7/1999	Woessner

(56)

References Cited

U.S. PATENT DOCUMENTS

5,928,145	A	7/1999	Ocali et al.	6,148,823	A	11/2000	Hastings
5,929,607	A	7/1999	Rosenberg et al.	6,152,933	A	11/2000	Werp et al.
5,931,788	A	8/1999	Keen et al.	6,157,853	A	12/2000	Blume et al.
5,931,818	A	8/1999	Werp et al.	6,165,144	A	12/2000	Talish et al.
5,931,863	A	8/1999	Griffin, III et al.	6,165,977	A	12/2000	Mochly-Rosen
5,941,858	A	8/1999	Johnson	6,166,496	A	12/2000	Lys et al.
5,941,889	A	8/1999	Cermak	6,166,806	A	12/2000	Tjin
5,941,904	A	8/1999	Johnston et al.	6,167,765	B1	1/2001	Weitzel
5,944,022	A	8/1999	Nardella et al.	6,172,499	B1	1/2001	Ashe
5,944,023	A	8/1999	Johnson et al.	6,173,199	B1	1/2001	Gabriel
5,951,598	A	9/1999	Bishay et al.	6,173,715	B1	1/2001	Sinanan et al.
5,953,683	A	9/1999	Hansen et al.	6,175,756	B1	1/2001	Ferre et al.
5,957,857	A	9/1999	Hartley	6,176,829	B1	1/2001	Vilkomerson
5,961,923	A	10/1999	Nova et al.	6,187,744	B1	2/2001	Rooney
5,967,978	A	10/1999	Littmann et al.	6,190,370	B1	2/2001	Tsui
5,967,980	A	10/1999	Ferre et al.	6,191,136	B1	2/2001	Marban
5,967,991	A	10/1999	Gardineer et al.	6,193,743	B1	2/2001	Brayton et al.
5,969,722	A	10/1999	Palm	6,197,001	B1	3/2001	Wilson et al.
5,971,933	A	10/1999	Gopakumaran et al.	6,200,305	B1	3/2001	Berthiaume et al.
5,978,705	A	11/1999	KenKnight et al.	6,203,499	B1	3/2001	Imling et al.
5,983,126	A	11/1999	Wittkamp	6,208,884	B1	3/2001	Kumar et al.
5,984,908	A	11/1999	Davis et al.	6,211,626	B1	4/2001	Lys et al.
5,991,693	A	11/1999	Zalewski	6,211,666	B1	4/2001	Acker
5,997,473	A	12/1999	Taniguchi et al.	6,212,426	B1	4/2001	Swanson
5,997,481	A	12/1999	Adams et al.	6,216,027	B1	4/2001	Willis et al.
6,006,123	A	12/1999	Nguyen et al.	6,216,028	B1	4/2001	Haynor et al.
6,011,988	A	1/2000	Lynch et al.	6,216,029	B1	4/2001	Paltieli
6,014,473	A	1/2000	Hossack et al.	6,223,087	B1	4/2001	Williams
6,014,580	A	1/2000	Blume et al.	6,226,547	B1	5/2001	Lockhart et al.
6,015,414	A	1/2000	Werp et al.	6,230,042	B1	5/2001	Slettenmark
6,017,496	A	1/2000	Nova et al.	6,230,046	B1	5/2001	Crane et al.
6,019,724	A	2/2000	Gronningsaeter et al.	6,231,518	B1	5/2001	Grabek et al.
6,019,725	A	2/2000	Vesely et al.	6,233,476	B1	5/2001	Strommer et al.
6,022,342	A	2/2000	Mukherjee	6,233,994	B1	5/2001	Roy et al.
6,023,638	A	2/2000	Swanson	6,236,883	B1	5/2001	Ciaccio et al.
6,026,312	A	2/2000	Shemwell et al.	6,238,344	B1	5/2001	Gamelsky et al.
6,031,765	A	2/2000	Lee et al.	6,241,673	B1	6/2001	Williams
6,032,070	A	2/2000	Flock et al.	6,246,231	B1	6/2001	Ashe
6,039,694	A	3/2000	Larson et al.	6,246,898	B1	6/2001	Vesely et al.
6,050,718	A	4/2000	Schena et al.	6,248,072	B1	6/2001	Murkin
6,052,610	A	4/2000	Koch	6,248,074	B1	6/2001	Ohno et al.
6,052,618	A	4/2000	Dahlke et al.	6,248,075	B1	6/2001	McGee et al.
D424,693	S	5/2000	Pruter	6,253,770	B1	7/2001	Acker et al.
6,059,718	A	5/2000	Taniguchi et al.	6,258,035	B1	7/2001	Hoeksel et al.
6,064,905	A	5/2000	Webster, Jr. et al.	6,259,941	B1	7/2001	Chia et al.
6,066,094	A	5/2000	Ben-Haim	6,261,231	B1	7/2001	Damphousse et al.
6,068,599	A	5/2000	Saito et al.	6,263,230	B1	7/2001	Haynor et al.
6,073,043	A	6/2000	Schneider	6,266,550	B1	7/2001	Selmon et al.
6,074,367	A	6/2000	Hubbell	6,266,551	B1	7/2001	Osadchy et al.
6,075,442	A	6/2000	Welch	6,266,552	B1	7/2001	Slettenmark
6,076,007	A	6/2000	England et al.	6,266,563	B1	7/2001	KenKnight et al.
6,081,737	A	6/2000	Shah	6,270,493	B1	8/2001	Lalonde et al.
6,082,366	A	7/2000	Andra et al.	6,271,833	B1	8/2001	Rosenberg et al.
6,083,170	A	7/2000	Ben-Haim	6,272,371	B1	8/2001	Shlomo
6,099,524	A	8/2000	Lipson et al.	6,272,374	B1	8/2001	Flock et al.
6,100,026	A	8/2000	Nova et al.	6,275,258	B1	8/2001	Chim
6,102,044	A	8/2000	Naidyhorski	6,275,724	B1	8/2001	Dickinson et al.
6,107,699	A	8/2000	Swanson	6,277,077	B1	8/2001	Brisken et al.
6,112,111	A	8/2000	Glantz	6,284,459	B1	9/2001	Nova et al.
6,112,115	A	8/2000	Feldman et al.	6,285,898	B1	9/2001	Ben-Haim
6,113,504	A	9/2000	Kuesters	6,287,260	B1	9/2001	Hascoet et al.
6,115,624	A	9/2000	Lewis et al.	6,288,704	B1	9/2001	Flack et al.
6,120,445	A	9/2000	Grunwald	6,292,678	B1	9/2001	Hall et al.
6,122,538	A	9/2000	Sliva, Jr. et al.	6,292,680	B1	9/2001	Somogyi et al.
6,128,174	A	10/2000	Ritter et al.	6,292,901	B1	9/2001	Lys et al.
6,129,668	A	10/2000	Haynor et al.	6,293,955	B1	9/2001	Houser et al.
6,132,378	A	10/2000	Marino	6,296,604	B1	10/2001	Garibaldi et al.
6,132,379	A	10/2000	Patacsil et al.	6,298,261	B1	10/2001	Rex
6,135,961	A	10/2000	Pflugrath et al.	6,304,768	B1	10/2001	Blume et al.
6,136,274	A	10/2000	Nova et al.	6,306,097	B1	10/2001	Park et al.
6,138,681	A	10/2000	Chen et al.	6,306,105	B1	10/2001	Rooney et al.
6,139,496	A	10/2000	Chen et al.	6,311,082	B1	10/2001	Creighton, IV et al.
6,139,502	A	10/2000	Fredriksen	6,315,709	B1	11/2001	Garibaldi et al.
6,139,540	A	10/2000	Rost et al.	6,315,727	B1	11/2001	Coleman et al.
6,144,300	A	11/2000	Dames et al.	6,319,668	B1	11/2001	Nova et al.
				6,323,769	B1	11/2001	Dames et al.
				6,323,770	B1	11/2001	Dames et al.
				6,324,416	B1	11/2001	Seibert
				6,325,540	B1	12/2001	Lounsberry et al.

(56)

References Cited

U.S. PATENT DOCUMENTS

6,325,762	B1	12/2001	Tjin	6,505,062	B1	1/2003	Ritter et al.
6,329,139	B1	12/2001	Nova et al.	6,506,159	B2	1/2003	Hascoet et al.
6,329,916	B1	12/2001	Dames et al.	6,507,751	B2	1/2003	Blume et al.
6,330,467	B1	12/2001	Creighton, IV et al.	6,508,802	B1	1/2003	Rosengart et al.
6,332,089	B1	12/2001	Acker et al.	6,511,413	B2	1/2003	Landesberg
6,332,874	B1	12/2001	Eliassen et al.	6,512,958	B1	1/2003	Swoyer et al.
6,340,588	B1	1/2002	Nova et al.	6,514,226	B1	2/2003	Levin et al.
6,340,868	B1	1/2002	Lys et al.	6,514,249	B1	2/2003	Maguire et al.
6,341,231	B1	1/2002	Ferre et al.	6,515,657	B1	2/2003	Zanelli
6,346,081	B1	2/2002	Vilkomerson	6,516,212	B1	2/2003	Bladen et al.
6,348,911	B1	2/2002	Rosenberg et al.	6,516,231	B1	2/2003	Flammang
6,350,160	B1	2/2002	Feuersanger et al.	6,516,807	B1	2/2003	Panescu et al.
6,352,363	B1	3/2002	Munger et al.	6,517,520	B2	2/2003	Chang et al.
6,354,999	B1	3/2002	Dgany et al.	6,522,906	B1	2/2003	Salisbury, Jr. et al.
6,355,026	B1	3/2002	Mick	6,522,907	B1	2/2003	Bladen et al.
6,356,791	B1	3/2002	Westlund et al.	6,522,909	B1	2/2003	Garibaldi et al.
6,360,123	B1	3/2002	Kimchi et al.	6,524,303	B1	2/2003	Garibaldi
6,361,499	B1	3/2002	Bates et al.	6,528,954	B1	3/2003	Lys et al.
6,364,823	B1	4/2002	Garibaldi et al.	6,528,991	B2	3/2003	Ashe
6,364,839	B1	4/2002	Little et al.	6,529,761	B2	3/2003	Creighton, IV et al.
6,366,804	B1	4/2002	Mejia	6,529,766	B1	3/2003	Guendel
6,368,285	B1	4/2002	Osadchy et al.	6,534,982	B1	3/2003	Jakab
6,370,411	B1	4/2002	Osadchy et al.	6,535,625	B1	3/2003	Chang et al.
6,373,240	B1	4/2002	Govari	6,537,192	B1	3/2003	Elliott et al.
6,373,388	B1	4/2002	Dames et al.	6,537,196	B1	3/2003	Creighton, IV et al.
6,374,134	B1	4/2002	Bladen et al.	6,538,634	B1	3/2003	Chui et al.
6,374,670	B1	4/2002	Spelman et al.	6,540,699	B1	4/2003	Smith et al.
6,375,606	B1	4/2002	Garibaldi et al.	6,542,766	B2	4/2003	Hall et al.
6,375,639	B1	4/2002	Duplessie et al.	6,544,251	B1	4/2003	Crawford
6,377,857	B1	4/2002	Brayton et al.	6,545,678	B1	4/2003	Ohazama
6,379,302	B1	4/2002	Kessman et al.	6,546,270	B1	4/2003	Goldin et al.
6,379,303	B1	4/2002	Seitz et al.	6,546,279	B1	4/2003	Bova et al.
6,379,307	B1	4/2002	Filly et al.	6,546,787	B1	4/2003	Schiller et al.
6,381,485	B1	4/2002	Hunter et al.	6,552,841	B1	4/2003	Lasser et al.
6,385,472	B1	5/2002	Hall et al.	6,556,858	B1	4/2003	Zeman
6,385,476	B1	5/2002	Osadchy et al.	6,562,019	B1	5/2003	Sell
6,398,736	B1	6/2002	Seward	6,564,087	B1	5/2003	Pitris et al.
6,398,738	B1	6/2002	Millar	6,569,101	B2	5/2003	Quistgaard et al.
6,401,723	B1	6/2002	Garibaldi et al.	6,569,103	B2	5/2003	Hoeksel et al.
6,406,422	B1	6/2002	Landesberg	6,569,160	B1	5/2003	Goldin et al.
6,406,442	B1	6/2002	McFann et al.	6,569,862	B1	5/2003	Marban
6,412,978	B1	7/2002	Watanabe et al.	6,571,004	B1	5/2003	Florent et al.
6,412,980	B1	7/2002	Lounsberry et al.	6,574,518	B1	6/2003	Lounsberry et al.
6,417,839	B1	7/2002	Odell	6,575,908	B2	6/2003	Barnes et al.
6,418,332	B1	7/2002	Mastrototaro et al.	6,577,080	B2	6/2003	Lys et al.
6,418,335	B2	7/2002	Avrin et al.	6,577,896	B2	6/2003	Werner et al.
6,423,002	B1	7/2002	Hossack	6,584,343	B1	6/2003	Ransbury et al.
6,423,050	B1	7/2002	Twardowski	6,593,754	B1	7/2003	Steber et al.
6,427,079	B1	7/2002	Schneider et al.	6,593,884	B1	7/2003	Gilboa et al.
6,428,551	B1	8/2002	Hall et al.	6,597,943	B2	7/2003	Taha et al.
6,430,315	B1	8/2002	Makram-Ebeid	6,599,249	B1	7/2003	Nordgren et al.
6,432,069	B1	8/2002	Godo et al.	6,607,488	B1	8/2003	Jackson et al.
6,438,411	B1	8/2002	Guttman et al.	6,610,058	B2	8/2003	Flores
6,442,416	B1	8/2002	Schultz	6,611,141	B1	8/2003	Schulz et al.
6,445,943	B1	9/2002	Ferre et al.	6,615,071	B1	9/2003	Casscells, III et al.
6,456,874	B1	9/2002	Hafer et al.	6,615,155	B2	9/2003	Gilboa
6,459,919	B1	10/2002	Lys et al.	6,616,610	B2	9/2003	Steininger et al.
6,463,121	B1	10/2002	Milnes	6,618,612	B1	9/2003	Acker et al.
6,466,815	B1	10/2002	Saito et al.	6,626,832	B1	9/2003	Paltieli et al.
6,471,656	B1	10/2002	Shalman et al.	6,626,834	B2	9/2003	Dunne et al.
6,471,658	B1	10/2002	Daniels et al.	6,626,902	B1	9/2003	Kucharczyk et al.
6,471,700	B1	10/2002	Burbank et al.	6,630,879	B1	10/2003	Creighton, IV et al.
6,473,167	B1	10/2002	Odell	6,635,027	B1	10/2003	Cragg et al.
6,474,341	B1	11/2002	Hunter et al.	6,645,148	B2	11/2003	Nguyen-Dinh et al.
6,475,152	B1	11/2002	Kelly, Jr. et al.	6,648,875	B2	11/2003	Simpson et al.
6,475,223	B1	11/2002	Werp et al.	6,649,914	B1	11/2003	Moorman et al.
6,477,402	B1	11/2002	Lynch et al.	6,652,505	B1	11/2003	Tsugita
6,484,118	B1	11/2002	Govari et al.	6,652,506	B2	11/2003	Bowe et al.
6,487,916	B1	12/2002	Gomm et al.	6,660,024	B1	12/2003	Flaherty et al.
6,491,671	B1	12/2002	Larson, III et al.	6,662,034	B2	12/2003	Segner et al.
6,493,573	B1	12/2002	Martinelli et al.	6,663,661	B2	12/2003	Boneau
6,494,832	B1	12/2002	Feldman et al.	6,666,828	B2	12/2003	Greco et al.
6,496,715	B1	12/2002	Lee et al.	6,672,308	B1	1/2004	Gaspari
6,498,944	B1	12/2002	Ben-Haim et al.	6,677,752	B1	1/2004	Creighton, IV et al.
6,500,141	B1	12/2002	Irion et al.	6,679,857	B1	1/2004	Bastia et al.
				6,684,176	B2	1/2004	Willins et al.
				6,685,644	B2	2/2004	Seo
				6,687,531	B1	2/2004	Ferre et al.
				6,689,119	B1	2/2004	Di Caprio et al.

(56)

References Cited

U.S. PATENT DOCUMENTS

6,690,963	B2	2/2004	Ben-Haim et al.	6,976,962	B2	12/2005	Bullis
6,690,964	B2	2/2004	Bieger et al.	6,976,987	B2	12/2005	Flores
6,690,968	B2	2/2004	Mejia	6,980,843	B2	12/2005	Eng et al.
6,694,167	B1	2/2004	Ferre et al.	6,980,852	B2	12/2005	Jersey-Willuhn et al.
6,695,786	B2	2/2004	Wang et al.	6,980,921	B2	12/2005	Anderson et al.
6,701,179	B1	3/2004	Martinelli et al.	6,986,739	B2	1/2006	Warren et al.
6,701,918	B2	3/2004	Fariss et al.	6,986,744	B1	1/2006	Krivitski
6,702,804	B1	3/2004	Ritter et al.	6,999,821	B2	2/2006	Jenney et al.
6,704,590	B2	3/2004	Haldeman	7,001,355	B2	2/2006	Nunomura et al.
6,709,390	B1	3/2004	Marie Pop	7,008,418	B2	3/2006	Hall et al.
6,711,429	B1	3/2004	Gilboa et al.	7,010,338	B2	3/2006	Ritter et al.
6,711,431	B2	3/2004	Sarin et al.	7,015,393	B2	3/2006	Weiner et al.
6,719,699	B2	4/2004	Smith	7,017,584	B2	3/2006	Garibaldi et al.
6,719,724	B1	4/2004	Walker et al.	7,019,610	B2	3/2006	Creighton, IV et al.
6,719,756	B1	4/2004	Muntermann	7,020,512	B2	3/2006	Ritter et al.
6,720,745	B2	4/2004	Lys et al.	D518,574	S	4/2006	Chaggares
6,733,458	B1	5/2004	Steins et al.	7,022,075	B2	4/2006	Grunwald et al.
6,733,511	B2	5/2004	Hall et al.	7,022,082	B2	4/2006	Sonek
6,736,782	B2	5/2004	Pfeiffer et al.	7,026,927	B2	4/2006	Wright et al.
6,738,656	B1	5/2004	Ferre et al.	7,027,634	B2	4/2006	Odell
6,740,103	B2	5/2004	Hall et al.	7,028,387	B1	4/2006	Huynh et al.
6,743,177	B2	6/2004	Ito et al.	7,029,446	B2	4/2006	Wendelken et al.
6,754,596	B2	6/2004	Ashe	7,033,603	B2	4/2006	Nelson et al.
6,755,789	B2	6/2004	Stringer et al.	D520,139	S	5/2006	Chaggares
6,755,816	B2	6/2004	Ritter et al.	D520,140	S	5/2006	Chaggares
6,755,822	B2	6/2004	Reu et al.	7,038,398	B1	5/2006	Lys et al.
6,757,557	B1	6/2004	Bladen et al.	7,038,657	B2	5/2006	Rosenberg et al.
6,763,261	B2	7/2004	Casscells, III et al.	7,043,293	B1	5/2006	Baura
6,764,449	B2	7/2004	Lee et al.	7,048,733	B2	5/2006	Hartley et al.
6,768,496	B2	7/2004	Bieger et al.	7,054,228	B1	5/2006	Hickling
6,772,001	B2	8/2004	Maschke et al.	7,065,403	B1	6/2006	Mouchawar et al.
6,774,624	B2	8/2004	Anderson et al.	7,066,914	B2	6/2006	Andersen
6,783,536	B2	8/2004	Vilmsmeier et al.	7,066,924	B1	6/2006	Garibaldi et al.
6,784,660	B2	8/2004	Ashe	7,069,072	B2	6/2006	Jansen et al.
6,785,571	B2	8/2004	Glossop et al.	D525,363	S	7/2006	Chaggares
6,786,219	B2	9/2004	Garibaldi et al.	7,070,565	B2	7/2006	Vaezy et al.
6,786,870	B2	9/2004	Miyaki et al.	7,072,704	B2	7/2006	Bucholz
6,788,967	B2	9/2004	Ben-Haim et al.	7,082,325	B2	7/2006	Hashimshony et al.
6,794,667	B2	9/2004	Noshi	7,090,639	B2	8/2006	Govari
6,799,066	B2	9/2004	Steines et al.	7,096,059	B2	8/2006	Geddes et al.
6,815,651	B2	11/2004	Odell	7,096,148	B2	8/2006	Anderson et al.
6,816,266	B2	11/2004	Varshneya et al.	7,096,870	B2	8/2006	Lamprich et al.
6,817,364	B2	11/2004	Garibaldi	7,098,907	B2	8/2006	Houston et al.
6,834,201	B2	12/2004	Gillies et al.	7,103,205	B2	9/2006	Wang et al.
6,844,713	B2	1/2005	Steber et al.	7,104,980	B1	9/2006	Laherty et al.
6,845,142	B2	1/2005	Ohishi	7,106,043	B1	9/2006	Da Silva et al.
6,856,823	B2	2/2005	Ashe	7,106,431	B2	9/2006	Odell
6,860,422	B2	3/2005	Hull et al.	7,106,479	B2	9/2006	Roy et al.
6,862,467	B2	3/2005	Moore et al.	7,107,105	B2	9/2006	Bjorklund et al.
6,869,390	B2	3/2005	Elliott et al.	7,112,197	B2	9/2006	Hartley et al.
6,875,179	B2	4/2005	Ferguson et al.	7,128,734	B1	10/2006	Wilson et al.
6,879,160	B2	4/2005	Jakab	7,132,804	B2	11/2006	Lys et al.
6,887,206	B2	5/2005	Hoeksel et al.	7,137,976	B2	11/2006	Ritter et al.
6,889,091	B2	5/2005	Hine et al.	7,141,019	B2	11/2006	Pearlman
6,895,268	B1	5/2005	Rahn et al.	7,141,812	B2	11/2006	Appleby et al.
6,902,528	B1	6/2005	Garibaldi et al.	7,142,905	B2	11/2006	Slayton et al.
6,905,469	B2	6/2005	Hascoet et al.	7,148,970	B2	12/2006	de Boer
6,908,433	B1	6/2005	Pruter	7,153,291	B2	12/2006	Bierman
6,911,026	B1	6/2005	Hall et al.	7,161,453	B2	1/2007	Creighton, IV
6,923,782	B2	8/2005	O'Mahony et al.	7,162,291	B1	1/2007	Nachaliel
6,926,673	B2	8/2005	Roberts et al.	7,167,738	B2	1/2007	Schweikard et al.
6,926,674	B2	8/2005	Tenerz et al.	7,169,107	B2	1/2007	Jersey-Willuhn et al.
6,934,575	B2	8/2005	Ferre et al.	7,169,109	B2	1/2007	Jansen et al.
6,936,010	B2	8/2005	Fang et al.	7,174,201	B2	2/2007	Govari et al.
6,939,313	B2	9/2005	Saadat et al.	7,175,646	B2	2/2007	Brenneman et al.
6,940,379	B2	9/2005	Creighton	7,180,252	B2	2/2007	Lys et al.
6,941,166	B2	9/2005	MacAdam et al.	7,184,820	B2	2/2007	Jersey-Willuhn et al.
6,947,788	B2	9/2005	Gilboa et al.	7,189,198	B2	3/2007	Harburn et al.
6,950,689	B1	9/2005	Willis et al.	7,189,205	B2	3/2007	McMorrow et al.
6,953,754	B2	10/2005	Machida et al.	7,189,208	B1	3/2007	Beatty et al.
6,958,677	B1	10/2005	Carter	7,190,819	B2	3/2007	Viswanathan
6,959,214	B2	10/2005	Pape et al.	7,194,295	B2	3/2007	Vilmsmeier
6,962,566	B2	11/2005	Quistgaard et al.	7,204,798	B2	4/2007	Zdeblick et al.
6,968,846	B2	11/2005	Viswanathan	7,206,064	B2	4/2007	Rogers et al.
6,975,197	B2	12/2005	Creighton, IV	7,207,941	B2	4/2007	Sharf
				7,211,082	B2	5/2007	Hall et al.
				7,214,191	B2	5/2007	Stringer et al.
				7,215,326	B2	5/2007	Rosenberg
				7,221,104	B2	5/2007	Lys et al.

(56)

References Cited

U.S. PATENT DOCUMENTS

7,223,256 B2	5/2007	Bierman	7,774,055 B1	8/2010	Min
7,229,400 B2	6/2007	Elliott et al.	7,794,407 B2	9/2010	Rothenberg
7,231,243 B2	6/2007	Tearney et al.	7,798,970 B2	9/2010	Lo et al.
7,236,157 B2	6/2007	Schena et al.	7,819,810 B2	10/2010	Stringer et al.
7,236,816 B2	6/2007	Kumar et al.	7,828,528 B2	11/2010	Estes et al.
7,236,820 B2	6/2007	Mabary et al.	7,831,294 B2	11/2010	Viswanathan
7,237,313 B2	7/2007	Skujins et al.	7,833,168 B2	11/2010	Taylor et al.
7,241,267 B2	7/2007	Furia	7,833,214 B2	11/2010	Wilson et al.
7,244,234 B2	7/2007	Ridley et al.	D629,526 S	12/2010	Ladwig et al.
7,248,032 B1	7/2007	Hular et al.	D629,527 S	12/2010	Crunkilton
7,248,914 B2	7/2007	Hastings et al.	7,846,157 B2	12/2010	Kozel
7,252,633 B2	8/2007	Obata et al.	7,850,613 B2	12/2010	Stribling
7,264,584 B2	9/2007	Ritter et al.	D630,756 S	1/2011	Kitayama
7,270,662 B2	9/2007	Visram et al.	D630,757 S	1/2011	Kitayama
7,276,044 B2	10/2007	Ferry et al.	7,869,854 B2	1/2011	Shachar et al.
7,286,034 B2	10/2007	Creighton	7,873,402 B2	1/2011	Shachar
7,291,146 B2	11/2007	Steinke et al.	7,909,815 B2	3/2011	Whitmore, III et al.
7,297,140 B2	11/2007	Orlu et al.	7,931,596 B2	4/2011	Rachlin et al.
7,300,430 B2	11/2007	Wilson et al.	7,947,040 B2	5/2011	Davies et al.
7,302,288 B1	11/2007	Schellenberg	7,976,469 B2	7/2011	Bonde et al.
7,308,296 B2	12/2007	Lys et al.	7,976,518 B2	7/2011	Shaughnessy et al.
7,310,150 B2	12/2007	Guillermo et al.	7,981,038 B2	7/2011	Kanade et al.
7,311,702 B2	12/2007	Tallarida et al.	7,988,633 B2	8/2011	Hossack et al.
7,321,228 B2	1/2008	Govari	8,016,814 B2	9/2011	Blakstvedt et al.
7,326,241 B2	2/2008	Jang	8,046,052 B2	10/2011	Verard et al.
7,327,872 B2	2/2008	Vaillant et al.	8,057,394 B2	11/2011	Dala-Krishna
7,342,058 B2	3/2008	Peppmoller et al.	8,060,185 B2	11/2011	Hunter et al.
7,349,732 B1	3/2008	Kil et al.	8,078,274 B2	12/2011	Kassab
7,355,716 B2	4/2008	de Boer et al.	8,078,279 B2	12/2011	Dennis et al.
7,360,427 B2	4/2008	Drinkwater et al.	8,082,032 B2	12/2011	Kassab et al.
7,366,376 B2	4/2008	Shishkov et al.	8,088,072 B2	1/2012	Munrow et al.
7,366,562 B2	4/2008	Dukesherer et al.	8,090,430 B2	1/2012	Makower et al.
7,366,563 B2	4/2008	Kleen et al.	8,099,161 B2	1/2012	Kassab
7,373,271 B1	5/2008	Schneider	8,114,143 B2	2/2012	Kassab et al.
7,381,204 B2	6/2008	Wilson et al.	8,118,743 B2	2/2012	Park et al.
7,382,949 B2	6/2008	Bouma et al.	8,123,691 B2	2/2012	Mine et al.
7,384,407 B2	6/2008	Rodriguez et al.	8,133,698 B2	3/2012	Silver
7,418,169 B2	8/2008	Tearney et al.	8,142,417 B2	3/2012	Pajunk et al.
7,447,408 B2	11/2008	Bouma et al.	8,150,522 B2	4/2012	Echaz et al.
7,452,331 B1	11/2008	Pruter	8,152,724 B2	4/2012	Ridley et al.
7,452,358 B2	11/2008	Stern et al.	8,204,582 B2	6/2012	Zantos et al.
7,454,244 B2	11/2008	Kassab et al.	8,214,018 B2	7/2012	Markowitz et al.
D585,556 S	1/2009	Kosaku	8,221,402 B2	7/2012	Francischelli et al.
7,479,141 B2	1/2009	Kleen et al.	8,240,211 B2	8/2012	Zeitner et al.
7,519,424 B2	4/2009	Dennis et al.	8,241,274 B2	8/2012	Keogh et al.
7,529,584 B2	5/2009	Laske et al.	8,244,339 B2	8/2012	Shen et al.
7,534,223 B2	5/2009	Boutillette et al.	8,255,035 B2	8/2012	Cao et al.
7,538,859 B2	5/2009	Tearney et al.	8,260,395 B2	9/2012	Markowitz et al.
7,543,239 B2	6/2009	Viswanathan et al.	8,262,577 B2	9/2012	Munrow et al.
7,546,158 B2	6/2009	Allison et al.	8,298,149 B2	10/2012	Hastings et al.
7,547,282 B2	6/2009	Lo et al.	8,303,502 B2	11/2012	Washburn et al.
7,551,293 B2	6/2009	Yelin et al.	8,303,505 B2	11/2012	Webler et al.
D603,050 S	10/2009	Chen	8,326,419 B2	12/2012	Rosenberg et al.
7,599,730 B2	10/2009	Hunter et al.	8,340,751 B2	12/2012	Markowitz et al.
7,606,615 B2	10/2009	Makower et al.	8,369,922 B2	2/2013	Paul et al.
7,616,992 B2	11/2009	Dennis et al.	8,388,541 B2	3/2013	Messery et al.
7,627,376 B2	12/2009	Dennis et al.	8,388,546 B2	3/2013	Rothenberg
7,635,336 B1	12/2009	Pruter	8,391,956 B2	3/2013	Zellers et al.
7,637,163 B2	12/2009	Fetzer et al.	8,401,616 B2	3/2013	Verard et al.
7,640,053 B2	12/2009	Verin	8,409,103 B2	4/2013	Grunwald et al.
7,651,469 B2	1/2010	Osborne et al.	8,425,425 B2	4/2013	Hagy et al.
7,652,080 B2	1/2010	Peppmoller et al.	8,437,833 B2	5/2013	Silverstein
7,660,623 B2	2/2010	Hunter et al.	8,439,873 B1	5/2013	Donovan
7,665,893 B2	2/2010	Buchalter	8,442,621 B2	5/2013	Gorek et al.
7,668,583 B2	2/2010	Fegert et al.	8,447,384 B2	5/2013	Xu et al.
7,697,972 B2	4/2010	Verard et al.	D684,265 S	6/2013	Cadera
7,699,782 B2	4/2010	Angelsen et al.	8,456,182 B2	6/2013	Bar-Tal et al.
7,699,829 B2	4/2010	Harris et al.	8,478,382 B2	7/2013	Burnside et al.
7,715,925 B2	5/2010	Hafer et al.	8,485,980 B2	7/2013	Sinderby et al.
7,727,192 B2	6/2010	Tokumoto et al.	8,494,608 B2	7/2013	Markowitz et al.
7,729,743 B2	6/2010	Sabczynski et al.	8,496,592 B2	7/2013	Ridley et al.
7,751,865 B2	7/2010	Jacob et al.	8,504,139 B2	8/2013	Jacobsen et al.
7,766,839 B2	8/2010	Rogers et al.	8,512,256 B2	8/2013	Rothenberg
7,771,437 B2	8/2010	Hogg et al.	8,527,036 B2	9/2013	Jalde et al.
7,774,051 B2	8/2010	Voth	8,538,509 B2 *	9/2013	Harlev et al. 600/509
			8,644,907 B2	2/2014	Hartmann et al.
			8,734,440 B2	5/2014	Wu
			8,774,907 B2	7/2014	Rothenberg
			8,781,555 B2	7/2014	Burnside et al.

(56)

References Cited

U.S. PATENT DOCUMENTS

8,784,336	B2	7/2014	Bown et al.	2004/0092962	A1	5/2004	Thornton et al.
8,801,693	B2	8/2014	He et al.	2004/0097803	A1	5/2004	Panescu
8,849,382	B2	9/2014	Cox et al.	2004/0097804	A1	5/2004	Sobe
8,858,455	B2	10/2014	Rothenberg	2004/0097805	A1	5/2004	Verard et al.
8,934,961	B2	1/2015	Lakin et al.	2004/0097806	A1	5/2004	Hunter et al.
8,971,994	B2	3/2015	Burnside et al.	2004/0116809	A1	6/2004	Chow et al.
9,125,578	B2	9/2015	Grunwald	2004/0127805	A1	7/2004	MacAdam et al.
9,339,206	B2	5/2016	Grunwald	2004/0131998	A1	7/2004	Marom et al.
9,456,766	B2	10/2016	Cox et al.	2004/0133111	A1	7/2004	Szczech et al.
2002/0010392	A1	1/2002	Desai	2004/0133130	A1	7/2004	Ferry et al.
2002/0019447	A1	2/2002	Renn et al.	2004/0135069	A1	7/2004	Odell
2002/0022777	A1	2/2002	Crieghton et al.	2004/0138557	A1	7/2004	Le et al.
2002/0032391	A1	3/2002	McFann et al.	2004/0138564	A1	7/2004	Hwang et al.
2002/0049488	A1	4/2002	Boneau	2004/0138570	A1	7/2004	Nita et al.
2002/0055680	A1	5/2002	Miele et al.	2004/0147837	A1	7/2004	Macaulay et al.
2002/0082559	A1	6/2002	Chang et al.	2004/0150963	A1	8/2004	Holmberg et al.
2002/0113555	A1	8/2002	Lys et al.	2004/0152972	A1	8/2004	Hunter
2002/0123679	A1	9/2002	Dominguez	2004/0155609	A1	8/2004	Lys et al.
2002/0128554	A1	9/2002	Seward	2004/0158140	A1	8/2004	Fuimaono et al.
2002/0129952	A1	9/2002	Matsudate et al.	2004/0171924	A1	9/2004	Mire et al.
2002/0133079	A1	9/2002	Sandhu	2004/0176688	A1	9/2004	Haldeman
2002/0156363	A1	10/2002	Hunter et al.	2004/0186461	A1	9/2004	DiMatteo
2002/0156376	A1	10/2002	Wang et al.	2004/0199069	A1	10/2004	Connelly et al.
2002/0165448	A1	11/2002	Ben-Haim et al.	2004/0210289	A1	10/2004	Wang et al.
2002/0165534	A1	11/2002	Hayzelden et al.	2004/0225233	A1	11/2004	Frankowski et al.
2002/0165537	A1	11/2002	Kelley et al.	2004/0230131	A1	11/2004	Kassab et al.
2002/0198568	A1	12/2002	Hafer et al.	2004/0230271	A1	11/2004	Wang et al.
2003/0009132	A1	1/2003	Schwartz et al.	2004/0234453	A1	11/2004	Smith
2003/0011359	A1	1/2003	Ashe	2004/0243018	A1	12/2004	Organ et al.
2003/0013966	A1	1/2003	Barnes et al.	2004/0243116	A1	12/2004	Joye et al.
2003/0013986	A1	1/2003	Saadat	2004/0243118	A1	12/2004	Ayers et al.
2003/0036696	A1	2/2003	Willis et al.	2004/0253365	A1	12/2004	Warren et al.
2003/0040671	A1	2/2003	Somogyi et al.	2004/0254470	A1	12/2004	Drinkwater et al.
2003/0040743	A1	2/2003	Cosman et al.	2004/0254495	A1	12/2004	Mabary et al.
2003/0072805	A1	4/2003	Miyazawa et al.	2004/0260174	A1	12/2004	Keene
2003/0073901	A1	4/2003	Simon et al.	2004/0267086	A1	12/2004	Anstadt et al.
2003/0076281	A1	4/2003	Morgan et al.	2005/0004450	A1	1/2005	Ben-Haim et al.
2003/0083698	A1	5/2003	Whitehurst et al.	2005/0021019	A1	1/2005	Hashimshony et al.
2003/0088195	A1	5/2003	Vardi et al.	2005/0033150	A1	2/2005	Takahashi et al.
2003/0100849	A1	5/2003	Jang	2005/0038355	A1	2/2005	Gellman et al.
2003/0114742	A1	6/2003	Lewkowicz et al.	2005/0043640	A1	2/2005	Chang
2003/0114777	A1	6/2003	Griffin et al.	2005/0049486	A1	3/2005	Urquhart et al.
2003/0120150	A1	6/2003	Govari	2005/0049510	A1	3/2005	Haldeman et al.
2003/0120154	A1	6/2003	Sauer et al.	2005/0063194	A1	3/2005	Lys et al.
2003/0139661	A1	7/2003	Kimchy et al.	2005/0070788	A1	3/2005	Wilson et al.
2003/0149328	A1	8/2003	Elliott et al.	2005/0075561	A1	4/2005	Golden
2003/0149368	A1	8/2003	Hennemann et al.	2005/0085716	A1	4/2005	Hamm et al.
2003/0152290	A1	8/2003	Odell	2005/0085718	A1	4/2005	Shahidi
2003/0160721	A1	8/2003	Gilboa et al.	2005/0085720	A1	4/2005	Jacob et al.
2003/0163037	A1	8/2003	Bladen et al.	2005/0090746	A1	4/2005	Ohtake
2003/0163142	A1	8/2003	Paltiel et al.	2005/0101868	A1	5/2005	Ridley et al.
2003/0171691	A1	9/2003	Casscells et al.	2005/0101869	A1	5/2005	Burba et al.
2003/0173953	A1	9/2003	Ashe	2005/0105081	A1	5/2005	Odell
2003/0181892	A1	9/2003	Pajunk et al.	2005/0105101	A1	5/2005	Duling et al.
2003/0184544	A1	10/2003	Prudent	2005/0112135	A1	5/2005	Cormier et al.
2003/0191392	A1	10/2003	Haldeman	2005/0113669	A1	5/2005	Helfer et al.
2003/0191460	A1	10/2003	Hobbs et al.	2005/0113676	A1	5/2005	Weiner et al.
2003/0195420	A1	10/2003	Mendlein et al.	2005/0113700	A1	5/2005	Yanagihara et al.
2003/0199746	A1	10/2003	Fuimaono et al.	2005/0113873	A1	5/2005	Weiner et al.
2003/0208142	A1	11/2003	Boudewijn et al.	2005/0113874	A1	5/2005	Connelly et al.
2003/0216639	A1	11/2003	Gilboa et al.	2005/0113876	A1	5/2005	Weiner et al.
2003/0220557	A1	11/2003	Cleary et al.	2005/0148836	A1	7/2005	Kleen et al.
2003/0220578	A1	11/2003	Ho et al.	2005/0148902	A1	7/2005	Minar et al.
2003/0229298	A1	12/2003	Iwami et al.	2005/0149002	A1	7/2005	Wang et al.
2003/0233042	A1	12/2003	Ashe	2005/0151489	A1	7/2005	Lys et al.
2003/0236445	A1	12/2003	Couvillon	2005/0154308	A1	7/2005	Quistgaard et al.
2004/0010189	A1	1/2004	van Sloun et al.	2005/0159644	A1	7/2005	Takano
2004/0015070	A1	1/2004	Liang et al.	2005/0159790	A1	7/2005	Shalev
2004/0024301	A1	2/2004	Hockett et al.	2005/0165301	A1	7/2005	Smith et al.
2004/0030319	A1	2/2004	Korkor et al.	2005/0165313	A1	7/2005	Byron et al.
2004/0054278	A1	3/2004	Kimchy et al.	2005/0175665	A1	8/2005	Hunter et al.
2004/0059237	A1	3/2004	Narayan et al.	2005/0175703	A1	8/2005	Hunter et al.
2004/0082916	A1	4/2004	Jenkins	2005/0178395	A1	8/2005	Hunter et al.
2004/0087877	A1	5/2004	Besz et al.	2005/0178396	A1	8/2005	Hunter et al.
2004/0088136	A1	5/2004	Ashe	2005/0182295	A1	8/2005	Soper et al.
				2005/0197674	A1	9/2005	McCabe et al.
				2005/0203368	A1	9/2005	Verin
				2005/0203396	A1	9/2005	Angelsen et al.
				2005/0205081	A1	9/2005	Barker et al.

(56)

References Cited

U.S. PATENT DOCUMENTS

2005/0215901	A1	9/2005	Anderson et al.	2007/0208255	A1	9/2007	Ridley et al.
2005/0215945	A1	9/2005	Harris et al.	2007/0219453	A1	9/2007	Kremliovskiy et al.
2005/0222532	A1	10/2005	Bertolero et al.	2007/0225589	A1	9/2007	Viswanathan
2005/0240102	A1	10/2005	Rachlin et al.	2007/0225610	A1	9/2007	Mickley et al.
2005/0245811	A1	11/2005	Scheffler	2007/0232882	A1	10/2007	Glossop et al.
2005/0256398	A1	11/2005	Hastings et al.	2007/0232896	A1	10/2007	Gilboa et al.
2005/0256451	A1	11/2005	Adams et al.	2007/0238984	A1	10/2007	Maschke et al.
2005/0256521	A1	11/2005	Kozel	2007/0239018	A1	10/2007	Fetzer et al.
2005/0256541	A1	11/2005	Stypulkowski	2007/0244413	A1	10/2007	Biggins
2005/0283210	A1	12/2005	Blischak et al.	2007/0247454	A1	10/2007	Rahn et al.
2005/0283216	A1	12/2005	Pyles	2007/0249911	A1	10/2007	Simon
2005/0288586	A1	12/2005	Ferek-Petric	2007/0255270	A1	11/2007	Carney
2006/0009759	A1	1/2006	Christian et al.	2007/0265526	A1	11/2007	Govari et al.
2006/0015003	A1	1/2006	Moaddes et al.	2007/0280974	A1	12/2007	Son et al.
2006/0025677	A1	2/2006	Verard et al.	2007/0282196	A1	12/2007	Birk et al.
2006/0025697	A1	2/2006	Kurzweil et al.	2007/0282197	A1	12/2007	Bill et al.
2006/0058633	A1	3/2006	Hoshino et al.	2007/0299352	A1	12/2007	Harlev et al.
2006/0068074	A1	3/2006	Stefandl	2007/0299353	A1	12/2007	Harlev et al.
2006/0084867	A1	4/2006	Tremblay et al.	2008/0004652	A1	1/2008	Abboud et al.
2006/0106306	A1	5/2006	Essner et al.	2008/0008745	A1	1/2008	Stinchcomb et al.
2006/0116571	A1	6/2006	Maschke et al.	2008/0009720	A1	1/2008	Schefelker et al.
2006/0116576	A1	6/2006	McGee et al.	2008/0015442	A1	1/2008	Watson et al.
2006/0116578	A1	6/2006	Grunwald et al.	2008/0027320	A1	1/2008	Bolorforosh et al.
2006/0122514	A1	6/2006	Byrd et al.	2008/0033283	A1	2/2008	Dellaca et al.
2006/0142656	A1	6/2006	Malackowski et al.	2008/0033316	A1	2/2008	Kassab et al.
2006/0149134	A1	7/2006	Soper et al.	2008/0033350	A1	2/2008	Wilson et al.
2006/0173251	A1	8/2006	Govari et al.	2008/0045908	A1	2/2008	Gould et al.
2006/0173329	A1	8/2006	Irioka et al.	2008/0051626	A1	2/2008	Sato et al.
2006/0173407	A1	8/2006	Shaughnessy et al.	2008/0077158	A1	3/2008	Haider et al.
2006/0176242	A1	8/2006	Jaramaz et al.	2008/0081958	A1	4/2008	Denison et al.
2006/0184074	A1	8/2006	Vaezy et al.	2008/0082136	A1	4/2008	Gaudiani
2006/0206037	A1	9/2006	Braxton	2008/0097232	A1	4/2008	Rothenberg
2006/0211944	A1	9/2006	Mauge et al.	2008/0108949	A1	5/2008	Beasley et al.
2006/0217655	A1	9/2006	Vitullo et al.	2008/0114095	A1	5/2008	Peppmoller et al.
2006/0224188	A1	10/2006	Libbus et al.	2008/0125772	A1	5/2008	Stone et al.
2006/0247746	A1	11/2006	Danek et al.	2008/0139944	A1	6/2008	Weymer et al.
2006/0258895	A1	11/2006	Maschke	2008/0146939	A1	6/2008	McMorrow et al.
2006/0276867	A1	12/2006	Viswanathan	2008/0146940	A1	6/2008	Jenkins et al.
2007/0010753	A1	1/2007	MacAdam	2008/0146942	A1	6/2008	Dala-Krishna
2007/0016007	A1	1/2007	Govari et al.	2008/0154100	A1	6/2008	Thalmeier et al.
2007/0016013	A1	1/2007	Camus	2008/0166453	A1	7/2008	Steele et al.
2007/0016068	A1	1/2007	Grunwald et al.	2008/0171934	A1	7/2008	Greenan et al.
2007/0016069	A1	1/2007	Grunwald et al.	2008/0183075	A1	7/2008	Govari et al.
2007/0016070	A1	1/2007	Grunwald et al.	2008/0188830	A1	8/2008	Rosenblatt et al.
2007/0016072	A1	1/2007	Grunwald et al.	2008/0190438	A1	8/2008	Harlev et al.
2007/0032746	A1	2/2007	Sell	2008/0195169	A1	8/2008	Pinter et al.
2007/0038113	A1	2/2007	Oonuki et al.	2008/0200754	A1	8/2008	Buchalter
2007/0049822	A1	3/2007	Bunce et al.	2008/0228082	A1	9/2008	Scheirer et al.
2007/0049846	A1	3/2007	Bown et al.	2008/0236598	A1	10/2008	Gobel
2007/0055141	A1	3/2007	Kruger et al.	2008/0255404	A1	10/2008	Nogawa et al.
2007/0055142	A1	3/2007	Webler	2008/0255475	A1	10/2008	Kondrosky et al.
2007/0060992	A1	3/2007	Pappone	2008/0269581	A1	10/2008	Wood et al.
2007/0062544	A1	3/2007	Rauk Bergstrom et al.	2008/0269611	A1	10/2008	Pedrizetti et al.
2007/0066888	A1	3/2007	Maschke	2008/0275465	A1	11/2008	Paul et al.
2007/0073155	A1	3/2007	Park et al.	2008/0275765	A1	11/2008	Kuchar
2007/0087038	A1	4/2007	Richardson et al.	2008/0288038	A1	11/2008	Paul et al.
2007/0093710	A1	4/2007	Maschke	2008/0294041	A1	11/2008	Kassab
2007/0100236	A1	5/2007	McMorrow et al.	2008/0319350	A1	12/2008	Wallace et al.
2007/0100285	A1	5/2007	Griffin et al.	2009/0005674	A1	1/2009	Saadat et al.
2007/0112282	A1	5/2007	Skujins et al.	2009/0005675	A1	1/2009	Grunwald et al.
2007/0123805	A1	5/2007	Shireman et al.	2009/0018497	A1	1/2009	Birchard et al.
2007/0129770	A1	6/2007	Younis	2009/0024018	A1	1/2009	Boyden et al.
2007/0135803	A1	6/2007	Belson	2009/0030380	A1	1/2009	Binmoeller
2007/0135886	A1	6/2007	Maschke	2009/0043205	A1	2/2009	Pelissier et al.
2007/0156205	A1	7/2007	Larson et al.	2009/0062684	A1	3/2009	Gregersen et al.
2007/0161853	A1	7/2007	Yagi et al.	2009/0082661	A1	3/2009	Saladin et al.
2007/0161914	A1	7/2007	Zdeblick et al.	2009/0084382	A1	4/2009	Jalde et al.
2007/0161915	A1	7/2007	Desai	2009/0101577	A1	4/2009	Fulkerson et al.
2007/0167738	A1	7/2007	Timinger et al.	2009/0118612	A1	5/2009	Grunwald et al.
2007/0167762	A1	7/2007	Kim et al.	2009/0118637	A1	5/2009	Kassab et al.
2007/0167769	A1	7/2007	Ikuma et al.	2009/0118706	A1	5/2009	Schweikert et al.
2007/0167801	A1	7/2007	Webler et al.	2009/0124901	A1	5/2009	Fink et al.
2007/0167997	A1	7/2007	Forsberg et al.	2009/0143736	A1	6/2009	Mittermeyer et al.
2007/0197891	A1	8/2007	Shachar et al.	2009/0156926	A1	6/2009	Messerly et al.
2007/0197905	A1	8/2007	Timinger et al.	2009/0163810	A1	6/2009	Kanade et al.
				2009/0171217	A1	7/2009	Kim et al.
				2009/0177083	A1	7/2009	Matsumura
				2009/0177090	A1	7/2009	Grunwald et al.
				2009/0203989	A1	8/2009	Burnside et al.

(56)

References Cited

U.S. PATENT DOCUMENTS

2009/0204113	A1	8/2009	MacAdam et al.	2011/0112396	A1	5/2011	Shachar et al.
2009/0209872	A1	8/2009	Pop	2011/0136242	A1	6/2011	Marx et al.
2009/0209950	A1	8/2009	Starksen	2011/0137156	A1	6/2011	Razzaque et al.
2009/0221908	A1	9/2009	Glossop	2011/0196235	A1	8/2011	Dunbar et al.
2009/0227952	A1	9/2009	Blakstvedt et al.	2011/0196248	A1	8/2011	Grunwald
2009/0234328	A1	9/2009	Cox et al.	2011/0196255	A1	8/2011	Kassab
2009/0253976	A1	10/2009	Harlev et al.	2011/0237935	A1	9/2011	Kalpin et al.
2009/0258171	A1	10/2009	Uang	2011/0245659	A1	10/2011	Ma et al.
2009/0259124	A1	10/2009	Rothenberg	2011/0282187	A1	11/2011	Harlev et al.
2009/0262982	A1	10/2009	Markowitz et al.	2011/0282188	A1	11/2011	Burnside et al.
2009/0270729	A1	10/2009	Corbucci et al.	2011/0295108	A1	12/2011	Cox et al.
2009/0270746	A1	10/2009	Min	2011/0306867	A1	12/2011	Gopinathan et al.
2009/0275828	A1	11/2009	Shachar et al.	2011/0313293	A1	12/2011	Lindekugel et al.
2009/0297441	A1	12/2009	Canham et al.	2012/0004564	A1	1/2012	Dobak, III
2010/0004543	A1	1/2010	Ahlund et al.	2012/0035460	A1	2/2012	Stangenes et al.
2010/0004547	A1	1/2010	Scholz et al.	2012/0046562	A1	2/2012	Powers et al.
2010/0010355	A1	1/2010	Kassab	2012/0059249	A1	3/2012	Verard et al.
2010/0010444	A1	1/2010	Bettuchi	2012/0071751	A1	3/2012	Sra et al.
2010/0010612	A1	1/2010	Gelbart et al.	2012/0071759	A1	3/2012	Hagy et al.
2010/0016726	A1	1/2010	Meier	2012/0071782	A1	3/2012	Patil et al.
2010/0036227	A1	2/2010	Cox et al.	2012/0078342	A1	3/2012	Vollkron et al.
2010/0036284	A1	2/2010	Laynes et al.	2012/0095319	A1	4/2012	Kondrosky et al.
2010/0041973	A1	2/2010	Vu et al.	2012/0108950	A1	5/2012	He et al.
2010/0041984	A1	2/2010	Shapland et al.	2012/0143029	A1	6/2012	Silverstein et al.
2010/0049062	A1	2/2010	Ziv	2012/0143078	A1	6/2012	Kassab et al.
2010/0055153	A1	3/2010	Majmudar	2012/0172727	A1	7/2012	Hastings et al.
2010/0055184	A1	3/2010	Zeitels et al.	2012/0220854	A1	8/2012	Messerly et al.
2010/0057157	A1	3/2010	Govari et al.	2012/0283582	A1	11/2012	Mahapatra et al.
2010/0060472	A1	3/2010	Kimura et al.	2012/0296200	A1	11/2012	Shachar et al.
2010/0063401	A1	3/2010	Nishina et al.	2012/0310052	A1	12/2012	Mahapatra et al.
2010/0076305	A1	3/2010	Maier-Hein et al.	2012/0310066	A1	12/2012	Shachar et al.
2010/0076328	A1	3/2010	Matsumura et al.	2012/0316440	A1	12/2012	Munrow et al.
2010/0081934	A1	4/2010	Soltani et al.	2013/0006102	A1	1/2013	Wilkes et al.
2010/0083719	A1	4/2010	Peppmoller et al.	2013/0018248	A1	1/2013	Hurezan
2010/0094116	A1	4/2010	Silverstein	2013/0035590	A1	2/2013	Ma et al.
2010/0106011	A1	4/2010	Byrd et al.	2013/0041269	A1	2/2013	Stahmann et al.
2010/0114573	A1	5/2010	Huang et al.	2013/0060116	A1	3/2013	Messerly et al.
2010/0117659	A1	5/2010	Osadchy et al.	2013/0085416	A1	4/2013	Mest
2010/0143119	A1	6/2010	Kooijman et al.	2013/0102890	A1	4/2013	Dib
2010/0152596	A1	6/2010	Griffiths et al.	2013/0123597	A1	5/2013	Rothenberg
2010/0168557	A1	7/2010	Deno et al.	2013/0169272	A1	7/2013	Eichler et al.
2010/0185097	A1	7/2010	Hall	2013/0217999	A1	8/2013	Burnside et al.
2010/0198048	A1	8/2010	Togawa	2013/0245434	A1	9/2013	Messerly et al.
2010/0198346	A1	8/2010	Keogh et al.	2013/0296691	A1	11/2013	Ashe
2010/0204569	A1	8/2010	Burnside et al.	2013/0303896	A1	11/2013	Kalpin et al.
2010/0204614	A1	8/2010	Lindquist et al.	2013/0317338	A1	11/2013	Silverstein
2010/0210938	A1	8/2010	Verard et al.	2013/0324841	A1	12/2013	Kamen et al.
2010/0210950	A1	8/2010	Dunbar et al.	2013/0338503	A1	12/2013	Cohen et al.
2010/0217116	A1	8/2010	Eck et al.	2013/0338517	A1	12/2013	Rothenberg
2010/0222664	A1	9/2010	Lemon et al.	2013/0345555	A1	12/2013	Kanade et al.
2010/0222786	A1	9/2010	Kassab	2014/0031674	A1	1/2014	Newman et al.
2010/0234724	A1	9/2010	Jacobsen et al.	2014/0046261	A1	2/2014	Newman et al.
2010/0234733	A1	9/2010	Wahlheim	2014/0094694	A1	4/2014	Moctezuma de La Barrera
2010/0249598	A1	9/2010	Smith et al.	2014/0094768	A1	4/2014	Stangenes et al.
2010/0258033	A1	10/2010	Yang et al.	2014/0107475	A1	4/2014	Cox et al.
2010/0268059	A1	10/2010	Ryu et al.	2014/0163356	A2	6/2014	Burnside et al.
2010/0273895	A1	10/2010	Stinchcomb et al.	2014/0180074	A1	6/2014	Green et al.
2010/0291521	A1	11/2010	Simon	2014/0187990	A1	7/2014	Banet et al.
2010/0298702	A1	11/2010	Rogers et al.	2014/0188133	A1	7/2014	Misener
2010/0298704	A1	11/2010	Pelissier et al.	2014/0228689	A1	8/2014	Ishikawa et al.
2010/0298705	A1	11/2010	Pelissier et al.	2014/0243659	A1	8/2014	Rothenberg
2010/0298712	A1	11/2010	Pelissier et al.	2014/0257080	A1	9/2014	Dunbar et al.
2010/0312086	A9	12/2010	Beatty et al.	2014/0275957	A1	9/2014	Lupotti
2010/0317981	A1	12/2010	Grunwald	2014/0275990	A1	9/2014	Hagy et al.
2010/0318026	A1	12/2010	Grunwald	2014/0303492	A1	10/2014	Burnside et al.
2010/0331712	A1	12/2010	Rothenberg	2014/0309624	A1	10/2014	Bown et al.
2011/0015527	A1	1/2011	Heasty et al.	2014/0343398	A1	11/2014	He et al.
2011/0015533	A1	1/2011	Cox et al.	2015/0005621	A1	1/2015	Liu
2011/0034823	A1	2/2011	Gelbart et al.	2015/0018701	A1	1/2015	Cox et al.
2011/0034940	A1	2/2011	Payner	2015/0025402	A1	1/2015	Rothenberg
2011/0040212	A1	2/2011	Dietz et al.	2015/0051489	A1	2/2015	Caluser et al.
2011/0052694	A1	3/2011	Stinchcomb et al.	2015/0080716	A1	3/2015	Powers et al.
2011/0087105	A1	4/2011	Ridley et al.	2015/0297114	A1	10/2015	Cox et al.
2011/0087106	A1	4/2011	Ridley et al.				
2011/0087107	A1	4/2011	Lindekugel et al.				

FOREIGN PATENT DOCUMENTS

AU	20009592	9/2000
AU	20015250	6/2001
AU	768362 B2	12/2003

(56)

References Cited

FOREIGN PATENT DOCUMENTS

AU	2001229024	B2	9/2005	WO	9403159	A1	2/1994
AU	2001283703	B2	5/2006	WO	9404938		3/1994
AU	2006202149		6/2006	WO	9605768	A1	2/1996
AU	2006904933		9/2006	WO	9607352	A1	3/1996
AU	2006283022	B2	2/2012	WO	9641119		12/1996
CA	2420676		2/2002	WO	9729683	A1	8/1997
CA	2619909	C	1/2014	WO	9743989	A1	11/1997
CN	2031655	U	2/1989	WO	9825159	A1	6/1998
CN	1672649	A	9/2005	WO	98/29032	A1	7/1998
CN	102209490	A	10/2011	WO	9835611	A1	8/1998
CN	102802514	A	11/2012	WO	9916495	A1	4/1999
CN	102821679	A	12/2012	WO	9927837	A2	6/1999
CN	103037761	A	4/2013	WO	9949407	A1	9/1999
CN	103037762	A	4/2013	WO	0019906		4/2000
CN	103118591	A	5/2013	WO	0027281	A1	5/2000
CN	103189009	A	7/2013	WO	0040155		7/2000
DE	4319033	C1	6/1994	WO	0063658	A2	10/2000
EP	0359697		3/1990	WO	0074775	A1	12/2000
EP	0362821		4/1990	WO	0113792	A1	3/2001
EP	0399536	A1	11/1990	WO	0139683	A1	6/2001
EP	0823261	A2	2/1998	WO	0176479	A1	10/2001
EP	0928976	A2	7/1999	WO	0215973	A1	2/2002
EP	1025805	A1	8/2000	WO	0219905	A1	3/2002
EP	1311226	A1	5/2003	WO	0225277	A1	3/2002
EP	1504713	A1	2/2005	WO	02085442	A1	10/2002
EP	1932477	A1	6/2008	WO	03061752		7/2003
EP	2313143	A1	4/2011	WO	03077759	A1	9/2003
EP	2337491	A1	6/2011	WO	03/088833	A1	10/2003
EP	2440122	A1	4/2012	WO	03091495	A1	11/2003
EP	2464407	A2	6/2012	WO	2004002303	A1	1/2004
EP	2482719	A1	8/2012	WO	2004049970	A2	6/2004
EP	2575610	A1	4/2013	WO	2005033524	A1	4/2005
EP	2575611	A1	4/2013	WO	2005033574	A1	4/2005
EP	2603145	A2	6/2013	WO	2005117690	A1	12/2005
EP	2605699	A2	6/2013	WO	2005117733	A2	12/2005
EP	2632360	A1	9/2013	WO	2006074509	A1	7/2006
EP	2219526	B1	3/2014	WO	2006074510	A1	7/2006
EP	2712547	A1	4/2014	WO	2006078677	A2	7/2006
EP	2313143	B1	9/2014	WO	2006103661	A2	10/2006
FR	2545349		11/1984	WO	2006111056	A1	10/2006
JP	01097440		4/1989	WO	2007002541	A2	1/2007
JP	03173542	A	7/1991	WO	2007005976	A1	1/2007
JP	4090741		8/1992	WO	2007014447	A1	2/2007
JP	9-503054		3/1997	WO	2007034196	A2	3/2007
JP	09-094298	A	4/1997	WO	2007067324	A1	6/2007
JP	10043310		2/1998	WO	2007069168	A2	6/2007
JP	10290839	A	11/1998	WO	2007109123	A2	9/2007
JP	11128237	A	5/1999	WO	2007126536	A2	11/2007
JP	2001161683		6/2001	WO	2007144894	A1	12/2007
JP	2001-514533	A	9/2001	WO	2008005480	A1	1/2008
JP	2001-524339	A	12/2001	WO	2008024596	A2	2/2008
JP	2001340334		12/2001	WO	2008028253		3/2008
JP	2002-529133	A	9/2002	WO	2008083111		7/2008
JP	2002-541947	A	12/2002	WO	2008097767	A2	8/2008
JP	2003-010138	A	1/2003	WO	2008118992	A1	10/2008
JP	2003501127	A	1/2003	WO	2008126074	A2	10/2008
JP	2003061752	A	3/2003	WO	2008129326	A1	10/2008
JP	2003299654		10/2003	WO	2008131017	A2	10/2008
JP	2003334191		11/2003	WO	2008136008	A2	11/2008
JP	2002520893		2/2004	WO	2009000439	A1	12/2008
JP	2004505748	T	2/2004	WO	2009002514	A2	12/2008
JP	2004515298	A	5/2004	WO	2009003138	A1	12/2008
JP	2006508744	A	3/2006	WO	2009009064	A1	1/2009
JP	2006-338526	A	12/2006	WO	2009057774	A1	5/2009
JP	2007-000226	A	1/2007	WO	2009063166	A1	5/2009
JP	2007-068989	A	3/2007	WO	2009067654	A1	5/2009
JP	2009/271123	A	11/2009	WO	2009070616	A2	6/2009
JP	5010604		6/2012	WO	2009100158	A1	8/2009
JP	2012-529929		11/2012	WO	2009123819	A2	10/2009
JP	2013-518676	A	5/2013	WO	2009126340	A1	10/2009
JP	2013-526959	A	6/2013	WO	2009129475	A1	10/2009
JP	2013-526961	A	6/2013	WO	2009129477	A1	10/2009
WO	8002376	A1	11/1980	WO	2009134605	A2	11/2009
WO	9112836	A1	9/1991	WO	2009137262	A2	11/2009
WO	9203090		3/1992	WO	2010002313	A1	1/2010
				WO	2010018500	A1	2/2010
				WO	2010022370	A1	2/2010
				WO	2010027349	A1	3/2010
				WO	2010027471	A2	3/2010

(56)

References Cited

FOREIGN PATENT DOCUMENTS

WO	2010029906	A1	3/2010
WO	2010030820	A1	3/2010
WO	2010132857	A1	11/2010
WO	2010132985	A1	11/2010
WO	2010143196	A1	12/2010
WO	2010144922	A1	12/2010
WO	2011019760	A2	2/2011
WO	2011041450	A1	4/2011
WO	2011044421	A1	4/2011
WO	2011057289	A2	5/2011
WO	2011064209	A1	6/2011
WO	2011084593	A2	7/2011
WO	2011097312	A1	8/2011
WO	2011128052	A2	10/2011
WO	2011120358	A1	12/2011
WO	2011150358	A1	12/2011
WO	2011150376	A1	12/2011
WO	2012021542	A2	2/2012
WO	2012024577	A2	2/2012
WO	2012039866	A1	3/2012
WO	2012040487	A1	3/2012
WO	2012058461	A1	5/2012
WO	2012083245	A1	6/2012
WO	2012088535	A1	6/2012
WO	2012110955	A1	8/2012
WO	2012173697	A1	12/2012
WO	2013006713	A2	1/2013
WO	2013006817	A1	1/2013
WO	2013034175	A1	3/2013
WO	2014052894	A2	4/2014
WO	2014062728	A1	4/2014
WO	2014138652	A1	9/2014
WO	2014138918	A1	9/2014
WO	2015/120256	A2	8/2015

OTHER PUBLICATIONS

U.S. Appl. No. 13/118,138, filed May 27, 2011 Non-Final Office Action dated Oct. 9, 2014.

RU 2011150917 filed Dec. 15, 2011 Second Office Action dated Aug. 28, 2014.

CN 200980144663.8 filed May 9, 2011 Fourth Office Action dated Nov. 15, 2014.

CN 201080035659.0 filed Feb. 10, 2012 Second Office Action dated Oct. 9, 2014.

CN 201080053838.7 filed May 28, 2012 Third Office Action dated Dec. 4, 2014.

CN 201180016462.7 filed Sep. 27, 2012 Second Office Action dated Dec. 9, 2014.

CN 201180037065.8 filed Jan. 28, 2013 First Office Action dated Sep. 28, 2014.

CN 201180037068.1 filed Jan. 28, 2013 First Office Action dated Sep. 9, 2014.

CN 201180040151.4 filed Feb. 19, 2013 First Office Action dated Oct. 28, 2014.

CN 201180043512.0 filed Mar. 8, 2013 First Office Action dated Jul. 31, 2014.

CN 201180068309.9 filed Aug. 22, 2013 First Office Action dated Oct. 16, 2014.

EP 11 818 828.3 filed Mar. 18, 2013 Extended European Search Report dated Dec. 10, 2014.

EP 12177438.4 filed Jul. 23, 2012 Examination Report dated Dec. 5, 2014.

EP 12807886.2 filed Jan. 15, 2014 Extended European Search Report dated Feb. 6, 2015.

JP 2012-552060 filed Aug. 1, 2012 Office Action dated Nov. 12, 2014.

Moureau, Nancy L. et al., "Electrocardiogram (EKG) Guided Peripherally Inserted Central Catheter Placement and Tip Position: Results of a Trial to Replace Radiological Confirmation," Journal of the Association for Vascular Access, pp. 8-14, vol. 15, No. 1, 2010.

MX/a/2012/013858 filed Nov. 28, 2012 First Office Action dated Sep. 26, 2014.

Pittiruti, et al., "The intracavitary ECG method for positioning the tip of central venous catheters: results of an Italian multicenter study," J Vasc Access, pp. 1-9, Nov. 21, 2011.

Pittiruti, et al., "The electrocardiographic method for positioning the tip of central venous catheters" JAVA, pp. 1-12, Feb. 12, 2011.

U.S. Appl. No. 12/426,175, filed Apr. 17, 2009 Examiner's Answer dated Oct. 7, 2014.

U.S. Appl. No. 12/545,762, filed Aug. 21, 2009 Non-Final Office Action dated Nov. 7, 2014.

U.S. Appl. No. 12/815,331, filed Jun. 14, 2010 Advisory Action dated Mar. 5, 2015.

U.S. Appl. No. 12/815,331, filed Jun. 14, 2010 Final Office Action dated Dec. 23, 2014.

U.S. Appl. No. 12/893,916, filed Sep. 29, 2010 Final Office Action dated Jan. 15, 2015.

U.S. Appl. No. 13/019,939, filed Feb. 2, 2011 Non-Final Office Action dated Feb. 9, 2015.

U.S. Appl. No. 13/118,033, filed May 27, 2011 Non-Final Office Action dated Feb. 3, 2015.

U.S. Appl. No. 13/336,919, filed Dec. 23, 2011 Final Office Action dated Dec. 19, 2014.

U.S. Appl. No. 13/665,420, filed Oct. 31, 2012 Non-Final Office Action dated Oct. 9, 2014.

U.S. Appl. No. 14/141,046, filed Dec. 26, 2013 Non-Final Office Action dated Feb. 11, 2015.

U.S. Appl. No. 14/317,501, filed Jun. 27, 2014 Non-Final Office Action dated Mar. 3, 2015.

"Ascension to Launch New 3D Guidance™ Tracker at TCT 2006." Press Releases from Ascension website: www.ascension-tech.com/news/press_101106.php, last accessed Dec. 1, 2006.

Acuson—The Value of Vision, AcuNav Diagnostic Ultrasound Catheter, 2000.

Advertising flyer for GAVECELT—The Italian Group for Long Term Venous Access Devices, for program on International Meeting on PICC's, Midline Catheters and Long Term Venous Access Devices in Catholic University, Rome, Italy on Dec. 3, 4, 5, 2008.

Alexander, Gd et al, The Role of Nitrous Oxide in Postoperative Nausea and Vomiting, Collection of Abstracts Presented at the International Anesthesia Research Society by various speakers, 58th Congress, Mar. 12-14, 1984, Anesthesia and Analgesia, pp. 175-284, vol. 63, 1984.

Allan, P.L. et al, Role of Ultrasound in the Assessment of Chronic Venous Insufficiency, Ultrasound Quarterly, vol. 17, No. 1, pp. 3-10, 2001.

Andropoulos, et al. "A Controlled Study of the Transesophageal Echocardiography to Guide Central Venous Catheter Placement in Congenital Heart Surgery Patients." The International Anesthesia Research Society, vol. 89, pp. 65-70, 1999.

Anonymous author, Correct Catheter Placement with a low-impact, reliable and economical method, <<http://www.cvc-partner.com/index.cfm?103A955CC6844BF58ACFE3C9C1471959>>, last accessed Dec. 22, 2011.

Arai, J et al, Detection of Peripherally Inserted Central Catheter Occlusion by in-line Pressure Monitoring, Paediatr Anaesth, pp. 621-624, vol. 12 No. 7, Sep. 2002.

Arrow International, Inc., The Arrow-Johans RAECG Adapter-Making Proper Central Venous Catheter Placement More Reliable (Modle No. EG-04900), Technical Report 1987, USA.

Aslamy, et al. "MRI of Central Venous Anatomy: Implications for Central Venous Catheter Insertion." American College of Chest Physicians, Jun. 8, 2009.

AU 2006283022 filed Aug. 24, 2006 Office Action dated Dec. 22, 2010.

AU 2008329807 exam requested Aug. 13, 2012 Examination Report No. 1 dated Feb. 15, 2013.

AU 2008329807 exam requested Aug. 13, 2012 Notice of Acceptance dated Feb. 14, 2014.

AU 2010300677 filed Mar. 12, 2012 First Examination Report dated Mar. 9, 2014.

AU 2011289513 filed Jan. 21, 2013 Examiner's Report dated Jul. 5, 2013.

(56)

References Cited

OTHER PUBLICATIONS

- AU 2012202293 filed Apr. 19, 2012 Examination Report No. 1 dated Apr. 24, 2013.
- AU 2013201648 filed Mar. 19, 2013 Examiner's Report dated Mar. 5, 2014.
- AU 2013201648 filed Mar. 19, 2013 Examiner's Report dated Oct. 14, 2013.
- AU 2013202824 filed Apr. 6, 2013 First Examiner's Report dated Mar. 10, 2014.
- AU 2013204243 filed Apr. 12, 2013 Examiner's Report dated Jun. 5, 2013.
- Aurora® System Technical Specifications, Oct. 2003.
- B. Braun Website, "The Optimal Position of the Central Venous Catheter." <http://www.cvcpartner.com/index.cfm18F1BDEA1310466194960A39F4E90968> (2009).
- B. Braun, Certofix Central Venous Catheter for Placement Using the Seldinger Technique with Simultaneous ECG Lead Option, Feb. 2010.
- Bailey, SH et al, Is Immediate Chest Radiograph Necessary after Central Venous Catheter Placement in a Surgical Intensive Care Unit?, *Am J Surg*, pp. 517-522, vol. 180 No. 6, Dec. 2000.
- Bankier, Alexander A., Azygos Arch Cannulation by Central Venous Catheters: Radiographic Detection of Malposition and Subsequent Complications, *Journal of Thoracic Imaging* 12:64-69 (1997).
- Barber, JM et al, A Nurse led Peripherally Inserted Central Catheter Line Insertion Service is Effective with Radiological Support, *Clin Radiol*, pp. 352-354, vol. 57 No. 5, May 2002.
- Bard Access Systems, Sherlock Tip Location System, 5 pages, 2006.
- Bard Access Systems, Site Rite Vascular Access Ultrasound System, 4 pages, 2005.
- Benchimol, Alberto et al, Right Atrium and Superior Vena Cava Flow Velocity in Man Measured with the Doppler-Catheter Flowmeter-Telemetry System, *The Amer Journal of Medicine*, pp. 303-309, vol. 48, Mar. 1970.
- Benzadon, M. N. et al: "Comparison of the Amplitude of the P-Wave from Intracardiac Electrocardiogram Obtained by Means of a Central Venous Catheter Filled With Saline Solution to That Obtained via Esophageal Electrocardiogram", *American Journal of Cardiology*, Canners Publishing Co., Newton, MA, US, vol. 98, No. 7, Oct. 1, 2006 (Oct. 1, 2006), pp. 978-981.
- BioAdvance Lumen Vu, Greenhouse Fund Feb. 2004 Recipient, www.bioadvance.com <<http://www.bioadvance.com>>, 2005.
- Borgobello, Bridget, App allows users to view electrocardiograms on smartphones dated Oct. 15, 2010; printed from <http://www.gizmag.com/app-to-view-electrocardiograms-on-smartphones/16664/> on Feb. 4, 2011.
- Buehrle, Douglas, PICC Placement in Humans using Electromagnetic Detection, <http://www.corpakmedsystems.com/supplement_material/supplementpages/navigator/navarticle.html>, 2008.
- C.R. Bard, CathTrack™ Catheter Location System at www.bardaccess.com <<http://www.bardaccess.com>>, last accessed Apr. 28, 2011.
- C.R. Bard, Inc., Bard Electrophysiology Product Catalogue, Bard Catheters, pp. 74-75 (2002), USA.
- CA 2,619,909 filed Aug. 24, 2006 Examiner's Report dated Oct. 26, 2012.
- Cadman, A et al, To Clot or Not to Clot? That is the question in Central Venous Catheters, *Clinical Radiology*, pp. 349-355, vol. 59 No. 4, Apr. 2004.
- Calvert, N et al, The Effectiveness and Cost-effectiveness of Ultrasound Locating Devices for Central Venous Access: A Systematic Review and Economic Evaluation, *Health Technology Assessment*, vol. 7, No. 12, 2003.
- Cardella, John F. et al., Interventinal Radiologic Placement of Peripherally Inserted Central Catheters, *Journal of Vascular and Interventional Radiology* 1993; 4:653-660.
- Carlson, R et al, Secondary Migration of a Central Venous Catheter—A Case Report, *Minerva Anestesiol*, pp. 927-931, vol. 69 No. 12, Dec. 2003.
- Caruso, LJ et al, A Better Landmark for Positioning a Central Venous Catheter, *J Clinical Monitoring and Computing*, pp. 331-334, vol. 17 No. 6, Aug. 2002.
- Cavatorta, et al., "Central Venous Catheter Placement in Hemodialysis: Evaluation of Electrocardiography Using a Guidewire." *The Journal of Vascular Access*, vol. 2, pp. 45-50, 2001.
- Chalkiadis, GA et al, Depth of Central Venous Catheter Insertion in Adults: An Audit and Assessment of a Technique to Improve Tip Position, *Anaesth Intensive Care*, pp. 61-66, vol. 26 No. 1, Feb. 1998.
- Chamsi-Pasha, Hassan et al, Cardiac Complications of Total Parenteral Nutrition: The Role of Two-Dimensional Echocardiography in Diagnosis, *Annals of the Royal College of Surgeons of England*, pp. 120-123, vol. 71, 1989.
- Chang, Thomas C. et al., Are Routine Ch Ladiographs Necessary After Image-Guided Placement of Internal Jugular Central Venous Access Devices?, *AJR* Feb. 1998;170:335-337.
- Chaturvedi et al., "Catheter Malplacement During Central Venous Cannulation Through Arm Veins in Pediatric Patients." *Journal of Neurosurgical Anesthesiology*, vol. 15, No. 3 pp. 170-175, Jan. 2003.
- Chen, Zhongping et al, Optical Doppler Tomography: Imaging in vivo Blood Flow Dynamics Following Pharmacological Intervention and Photodynamic Therapy, 7 pages, vol. 67, *Photochemistry and Photobiology*, 1998.
- Cheng, KI et al, A Novel Approach of Intravenous Electrocardiograph Technique in Correct Position the Long-Term Central Venous Catheter, *Kaohsiung J Med Sci*, pp. 241-247, vol. 16 No. 5, May 2000 (Abstract only).
- Cheung, P., et al., The Effect of a Disposable Probe Cover on Pulse Oximetry, *Anaesth Intensive Care* 2002; 30: 211-214.
- Chu, et al., "Accurate Central Venous Port—A Catheter Placement: Intravenous Electrocardiography and Surface Landmark Techniques Compared by Using Transesophageal Echocardiography." *The International Anesthesia Research Society*, vol. 98, pp. 910-914, 2004.
- CN 201180016462.7 filed Sep. 27, 2012 Third Office Action dated Jun. 10, 2015.
- CN 201180040151.4 filed Feb. 19, 2013 Second Office Action dated Jun., 19, 2015.
- MX/a/2012/013858 filed Nov. 28, 2012 Second Office Action dated Jun. 10, 2015.
- U.S. Appl. No. 13/118,138, filed May 27, 2011 Non-Final Office Action dated Jul. 15, 2015.
- U.S. Appl. No. 13/336,919, filed Dec. 23, 2011 Non-Final Office Action dated Jul. 9, 2015.
- U.S. Appl. No. 13/887,166, filed May 3, 2013 Examiner's Answer dated Jul. 16, 2015.
- U.S. Appl. No. 14/317,501, filed Jun. 27, 2014 Final Office Action dated Jul. 1, 2015.
- Claasz, Antonia et al, A Study of the Relationship of the Superior Vena Cava to the Bony Landmarks of the Sternum in the Supine Adult: Implications for Magnetic Guidance Systems, *Journal*, vol. 12 No. 3, *JAVA*, Jul. 24, 2007.
- Clifford, et al. "Assessment of Hepatic Motion Secondary to Respiration for Computer Assisted Interventions." *Computer Aided Surgery*, vol. 7, pp. 291-299, 2002.
- CN 200880012117.4 filed Apr. 16, 2008 First Office Action dated Dec. 23, 2011.
- CN 200880012117.4 filed Apr. 16, 2008 Second Office Action dated Oct. 8, 2012.
- CN 200880012117.4 filed Apr. 16, 2008 Third Office Action dated Apr. 27, 2013.
- CN 200880125528.4 filed Nov. 25, 2008 First Office Action dated Jun. 5, 2012.
- CN 200880125528.4 filed Nov. 25, 2008 Second Office Action dated Mar. 6, 2013.
- CN 200880125528.4 filed Nov. 25, 2008 Third Office Action dated Jul. 1, 2013.
- CN 200980123021.X filed Dec. 17, 2010 First Office Action dated Nov. 19, 2012.

(56)

References Cited

OTHER PUBLICATIONS

- CN 200980123021.X filed Dec. 17, 2010 Second Office Action dated Aug. 13, 2013.
- CN 200980123021.X filed Dec. 17, 2010 Third Office Action dated Apr. 22, 2014.
- CN 200980144663.8 filed May 9, 2011 First Office Action dated Dec. 5, 2012.
- CN 200980144663.8 filed May 9, 2011 Second Office Action dated Aug. 22, 2013.
- CN 200980144663.8 filed May 9, 2011 Third Office Action dated May 4, 2014.
- CN 201080035659.0 filed Feb. 10, 2012 First Office Action dated Jan. 26, 2014.
- CN 201080053838.7 filed May 28, 2012 First Office Action dated Jan. 6, 2014.
- CN 201080053838.7 filed May 28, 2012 Second Office Action dated Jun. 17, 2014.
- CN 201180016462.7 filed Sep. 27, 2012 First Office Action dated Mar. 21, 2014.
- Colley, Peter S et al, ECG-Guided Placement of Sorenson CVP Catheters via Arm Veins, *Anesthesia and Analgesia*, pp. 953-956, vol. 63, 1984.
- Collier, PE et al, Cardiac Tamponade from Central Venous Catheters, *Am J Surg*, pp. 212-214, vol. 176 No. 2, Aug. 1998.
- ComboWire® Pressure/Flow Guide Wire Ref 9500 Series, Instructions for Use, Apr. 2011.
- Corsten, et al., "Central Placement Catheter Placement Using the ECG-Guided Cavafix-Certodyn SD Catheter." *Journal of Clinical Anesthesiology*, vol. 6, Nov./Dec. 1994.
- Cucchiara, Roy et al, Time Required and Success Rate of Percutaneous Right Atrial Catheterization: Description of a Technique, *Canad. Anaesth. Soc. J.*, pp. 572-573, vol. 27, No. 6, Nov. 1980.
- Cullinane, DC et al, The Futility of Chest Roentgenograms Following Routine Central Venous Line Changes, *Am J Surg*, pp. 283-285, vol. 176 No. 3, Sep. 1998.
- Curet, Myriam J. et al., University and Practice-based Physicians' Input on the Content of a Surgical Curriculum, *The American Journal of Surgery*® vol. 178 Jul. 1999, 78-84.
- David, et al., "Is ECG-Guidance a Helpful Method to Correctly Position a Central Venous Catheter During Prehospital Emergency Care?" *ACTA Anaesthesiologica Scandinavica*, vol. 49, pp. 1010-1014, 2005.
- DELTEC Cath-Finder® Tracking System Operation Manual, 1994.
- Egelhof, Petra, Effects of Somatostatin on Portal Blood Flow and Portal Vein Pressure in Patients with Portal Hypertension due to Liver Cirrhosis Invasive Monitoring during TIPSS Procedures, Dissertation submitted to: Technical University of Munich, Faculty of Medicine, May 13, 2002; Date of examination: Feb. 26, 2003.
- Engelhardt, W et al, ECG-Controlled Placement of Central Venous Catheters in Patients with Atrial Fibrillation, *Anaesthesist*, pp. 476-479, vol. 38 No. 9, Sep. 1989 (Abstract only).
- EP 08855396.1 filed Jun. 15, 2010 European Search Report dated Jul. 31, 2012.
- EP 08855396.1 filed Jun. 15, 2010 Intent to Grant dated Jul. 5, 2013.
- EP 09707467.8 supplemental European search report dated Jun. 18, 2013.
- EP 09808901.4 filed Aug. 21, 2009 European Search Report dated May 23, 2012.
- EP 09808901.4 filed Aug. 21, 2009 Examination Report dated May 10, 2013.
- EP 09813632.8 filed Apr. 5, 2011 European Search Report dated Jul. 4, 2012.
- EP 09813632.8 filed Apr. 5, 2011 Office Action dated Apr. 30, 2013.
- EP 09813632.8 filed Apr. 5, 2011 Summons to Attend Oral Proceedings dated Apr. 16, 2014.
- EP 10 808 660.4 filed Feb. 15, 2012 Extended European Search Report dated Mar. 4, 2014.
- EP 10786978.6 filed Dec. 19, 2011 Extended European Search Report dated Mar. 7, 2014.
- EP 12177438.4 filed Jul. 23, 2012 Communication dated Jan. 13, 2014.
- EP 12177438.4 filed Jul. 23, 2012 European Search Report dated Dec. 4, 2012.
- EP 12177438.4 filed Jul. 23, 2012 extended European Search Report dated Mar. 25, 2013.
- EP 13194818.4 filed Nov. 28, 2013 extended European search report dated Feb. 28, 2014.
- EP 14151268.1 filed Jan. 15, 2014 European Search Report dated Feb. 21, 2014.
- Fearon, William F et al, Evaluating Intermediate Coronary Lesions in the Cardiac Catheterization Laboratory, vol. 4, No. 1, 7 pages, *Reviews in Cardiovascular Medicine*, 2003.
- Felleiter P et al, Use of Electrocardiographic Placement Control of Central Venous Catheters in Austria, *Acta Med Austriaca*, pp. 109-113, vol. 26 No. 3, 1999 (Abstract only).
- Forauer, AR et al, Change in Peripherally Inserted Central Catheter Tip Location with Abduction and Adduction of the Upper Extremity, *J Vasc Interv Radiol*, pp. 1315-1318, vol. 11 No. 10, Nov.-Dec. 2000.
- Frassinelli, P et al, Utility of Chest Radiographs after Guidewire Exchanges of Central Venous Catheters, *Crit Care Med*, pp. 611-615, vol. 26 No. 3, Mar. 1998.
- Frazin L et al, A Doppler Guided Retrograde Catheterization System, *Cathet. Cardiovasc Diagn*, pp. 41-50, May 1992.
- French, PJ et al, Sensors for Catheter Applications, *Sensors Update*, vol. 13 Issue 1 pp. 107-153, Dec. 2003.
- GB Application 0800474.9 filed Aug. 24, 2006 Office Action dated Aug. 9, 2010.
- GB Application 0800474.9 filed Aug. 24, 2006 Office Action dated Mar. 17, 2010.
- Gebauer, B et al, Ultrasound and Fluoroscopy-guided Implantation of Peripherally Inserted Central Venous Catheters (PICCs), *ROFO*, pp. 386-391, vol. 176 No. 3, Mar. 2004 (Abstract only).
- Gebhard, et al., "The accuracy of Electrocardiogram-Controlled Central Line Placement." *The International Anesthesia Research Society*, vol. 104, No. 1 Jan. 2007.
- Gjendemsjo, Anders, et al., Energy and Power, *The Connexions Project*, Version 1.2, Feb. 20, 2004.
- Gladwin, MT et al, Cannulation of the Internal Jugular Vein: is postprocedural chest radiography always necessary?, *Crit Care Med*, 33 pages, Oct. 2000.
- Gonzales, et al. "Peripherally Inserted Central Catheter Placement in Swine Using Magnet Detection." *Journal of Intravenous Nursing*, vol. 22, No. 3, May/June. 1999.
- Greenall, M.J. et al, Cardiac Tamponade and Central Venous Catheters, *British Medical Journal*, pp. 595-597, Jun. 14, 1975.
- Guillory, "Basic Principles of Technologies for Catheter Localization." C.R. Bard internal paper, Oct. 20, 2004.
- Guth, AA, Routine Chest X-rays after Insertion of Implantable Long-Term Venous Catheters: Necessary or Not?, *Am Surg*, pp. 26-29, vol. 67 No. 1, Jan. 2001 (Abstract only).
- Hill, Bradley et al, Abstract of article discussing Vassalova VPS as guide for placement of PICCs. 2009.
- Hill, Bradley, Identifying the Caval-Atrial Junction Using Smart-Catheter Technology presentation, 22nd Annual Scientific Meeting of the AVA in Savannah, Georgia, Sep. 13, 2008.
- Hoffman, Thomas et al, Simultaneous Measurement of Pulmonary Venous Flow by Intravascular Catheter Doppler Velocimetry and Transesophageal Doppler Echocardiography: Relation to Left Atrial Pressure and Left Atrial and Left Ventricular Function, pp. 239-249, *J Am Coll Cardiol*, Jul. 1995.
- Hoffmann, et al. "New Procedure in Transesophageal Echocardiography: Multiplane Transesophageal Echocardiography and Transesophageal Stress Echocardiography." *Herz*, vol. 18, No. 5, pp. 269-277, Oct. 1993.
- Iacopino, Domenico Gerardo et al, Intraoperative Microvascular Doppler Monitoring of Blood Flow within a Spinal Dural Arteriovenous Fistula: A Precious Surgical Tool, vol. 10, 5 pages, *Neurosurg. Focus*, Feb. 2001.

(56)

References Cited

OTHER PUBLICATIONS

- Jeon, Yunseok et al., "Transesophageal Echocardiographic Evaluation of ECG-guided Central Venous Catheter Placement," *Canadian Journal of Anesthesia*, vol. 53, No. 10, Oct. 1, 2006, pp. 978-983.
- Joosting, Jean-Pierre, "Dual-interface RFID-compatible EEPROM enables remote access to electronic device parameters," *EE Times*, Mar. 8, 2010.
- JP 2008-528151 filed Aug 24, 2006 Notice of Grant dated May 6, 2012.
- JP 2010-504220 filed Sep. 3, 2009 Final Office Action dated Apr. 18, 2013.
- JP 2010-504220 filed Sep. 3, 2009 Office Action dated May 21, 2012.
- JP 2010-535117 filed May 26, 2011 First Office Action dated Aug. 5, 2013.
- JP 2012-515222 filed Dec. 9, 2011 Office Action dated Mar. 24, 2014.
- Kim, Ko et al, Positioning Internal Jugular Venous Catheters using the Right Third Intercostal Space in Children, *Acta Anaesthesiol Scand*, pp. 1284-1286, vol. 47 No. 10, Nov. 2003.
- Kjelstrup T et al, Positioning of Central Venous Catheters using ECG, *Tidsskr nor Laegeforen*, pp. 599-601, vol. 111 No. 5, Feb. 1999 (Abstract only).
- Kofler, Julia, et al., Epinephrine application via an endotracheal airway and via the Combitube in esophageal position, *Critical Care Medicine: May 2000*, vol. 28: Issue 5, pp. 1445-1449.
- Konings, MK, et al., Development of an intravascular impedance catheter for detection of fatty lesions in arteries, *IEEE Trans Med Imaging* Aug. 1997; 16(4):439-46.
- Kowalski, CM et al. Migration of Central Venous Catheters: Implications for Initial Catheter Tip Positioning, *J Vasc Interv Radiol*, pp. 443-447, vol. 8 No. 3, May-Jun. 1997.
- Leowenthal, MR et al, The Peripherally Inserted Central Catheter (PICC): A Prospective Study of its Natural History after Fossa Insertion, *Anaesth Intensive Care*, pp. 21-24; vol. 30 No. 1, Feb. 2002.
- Lepage Ronan et al. ECG Segmentation and P-wave Feature Extraction: Application to Patients Prone to Atrial Fibrillation, *IEEE/EMBS Proceedings, 23rd Annual Conference, Istanbul, Turkey*, Oct. 25-28, 2001.
- Liu, Ji-Bin et al, Catheter-Based Intraluminal Sonography, *J Ultrasound Med*, pp. 145-160, vol. 23, 2004.
- Lucey, B et al, Routine Chest Radiographs after Central Line Insertion: Mandatory Postprocedural Evaluation or Unnecessary Waste of Resources?, *Cardiovasc Intervent Radiol*, pp. 381-384, vol. 22 No. 5, Sep.-Oct. 1999.
- Lum, Phillip, A New Formula-Based Measurement Guide for Optimal Positioning of Central Venous Catheters, *JAVA*, vol. 9, No. 2, pp. 80-85, 2004.
- Lynch, RE et al, A Procedure for Placing Pediatric Femoral Venous Catheter Tips near the Right Atrium, *Pediatr Emerg Care*, pp. 130-132, vol. 18 No. 2, Apr. 2002.
- Madan, et al. "Right Atrial Electrocardiography: A Technique for the Placement of Central Venous Catheters for Chemotherapy or Intravenous Nutrition." *British Journal of Surgery*, vol. B1, pp. 1604-1605, 1994.
- Madias, John E, Intracardiac (Superior Vena Cava/Right Atrial) ECGs using Saline Solution as the Conductive Medium for the Proper Positioning of the Shiley Hemodialysis Catheter: Is it Not Time to Forego the Postinsertion Chest Radiograph?, pp. 2363-2367, *Chest*, 2003.
- Markovich, Mary B., Central Venous Catheter Tip Placement: Determination of Posterior Malposition—A Case Study, *JAVA*, vol. 11, No. 2, pp. 85-89, 2006.
- Martin, Roy W, An Ultrasound Catheter for Intravascular Measurement of Blood Flow: Technical Details, *IEEE Transactions on Sonics and Ultrasonics*, vol. SU-27, No. 6, pp. 277-286, Nov. 1980.
- McDonnell, "Intra-Atrial Electrocardiography (ECG) for Catheter Placement." Literature review prepared for Bard Access Systems, Oct. 2007.
- McGee et al., "Accurate Placement of Central Venous Catheters: A Prospective, Randomize, Multicenter Trail." *Critical Care Medicine*, vol. 21 No. 8, Aug. 1993.
- MedGraphics, CardioPerfect® Resting/Stress ECG System, 3 pages, 2001.
- Michenfelder, John et al, Air Embolism During Neurosurgery—An Evaluation of Right-Atrial Catheters for Diagnosis and Treatment, *JAMA*, pp. 1353-1358, vol. 208, No. 8, May 26, 1969.
- Michenfelder, John et al, Air Embolism During Neurosurgery: A New Method of Treatment, *Anesthesia and Analgesia. Current Researches*, pp. 390-395, vol. 45, No. 4, Jul.-Aug. 1966.
- Microbird™ Miniaturized DC Magnetic Sensors for Intra-body Navigation and Localization, Specifications, 2005.
- Micronix CathRite™ Cardiac Access Device Brochure. Jun. 2004.
- Micronix Pty Ltd "CathRite" Guiding Styled Core Manufacturing, Jun. 15, 2006.
- Murthy, Vrudhula et al, Analysis of Power Spectral Densities of Electrocardiograms, *Mathematical Biosciences*, pp. 41-51, vol. 12 No. 1-2, Oct. 1971.
- Nadroo, AM et al, Changes in Upper Extremity Position Cause Migration of Peripherally Inserted Central Catheters in Neonates, *Pediatrics*, pp. 131-136, vol. 110, Jul. 2002.
- Nakatani, K et al, Accurate Placement of Central Venous Catheters—ECG-guided method vs Patient Height Method, *MASUI*, pp. 34-38, vol. 51 No. 1, Jan. 2002.
- Nazarian, GK et al, Changes in Tunneled Catheter Tip Position when a patient is Upright, *J Vasc Interv Radiol*, pp. 437-441, vol. 8 No. 3, May-Jun. 1997.
- Neurometer® CPT, Clinical Applications. Neurotron, Inc. website: www.neurotron.com/CLINAPS.html, last accessed Oct. 23, 2006.
- PCT/US2011/052793 filed Sep. 22, 2011 International Preliminary Report on Patentability dated Apr. 4, 2013.
- PCT/US2011/052793 filed Sep. 22, 2011 International Search Report dated Jan. 6, 2012.
- PCT/US2011/052793 filed Sep. 22, 2011 Written Opinion dated Jan. 6, 2012.
- PCT/US2011/058138 filed Oct. 27, 2011 International Preliminary Report on Patentability dated May 10, 2013.
- PCT/US2011/058138 filed Oct. 27, 2011 International Search Report dated Feb. 7, 2012.
- PCT/US2011/058138 filed Oct. 27, 2011 Written Opinion dated Feb. 7, 2012.
- PCT/US2011/067268 filed Dec. 23, 2011 International Preliminary Report on Patentability dated Jul. 4, 2013.
- PCT/US2011/067268 filed Dec. 23, 2011 International Search Report and Written Opinion dated Apr. 27, 2012.
- PCT/US2012/045814 filed Jul. 6, 2012 International Search Report and Written Opinion dated Oct. 1, 2012.
- PCT/US2013/065121 filed Oct. 15, 2013 International Search Report and Written Opinion dated Jan. 16, 2014.
- PCT/US2014/022019 filed Mar. 7, 2014 International Search Report and Written Opinion dated Jun. 11, 2014.
- Pennington, C.R., Right Atrial Thrombus: a Complication of Total Parenteral Nutrition, *British Medical Journal*, pp. 446-447, vol. 295, Aug. 15, 1987.
- Petersen, J et al, Silicone Venous Access Devices Positioned with their Tip High in the Superior Vena Cava are More Likely to Malfunction, *Am J Surg*, pp. 38-41, vol. 178 No. 1, Jul. 1999.
- Pittiruti, et al, Intracavitary EKG Monitoring: A reliable method for controlling tip position during and after PICC Insertion presentation in Catholic University, Rome, Italy in 2008.
- Pittiruti, et al. "The EKG Method for Positioning the Tip of PICCs: Results from Two Preliminary Studies." *JAVA*, vol. 13, No. 4, pp. 179-185, 2008.
- Polos, PG et al, Tips for Monitoring the Position of a Central Venous Catheter—How Placement can go awry—even when the anatomy is normal, *J Crit Illn*, pp. 660-674, vol. 8 No. 6, Jun. 1993 (Abstract only).
- Pop, Gheorghe A. et al., Catheter-based impedance measurements in the right atrium for continuously monitoring hematocrit and esti-

(56)

References Cited

OTHER PUBLICATIONS

- inating blood viscosity changes; an in vivo feasibility study in swine, *Biosensors and Bioelectronics* 19 (2004) 1685-1693.
- Popp, M. B. et al., Accuracy of implanted port placement with the use of the electromagnetic CathTrack® catheter locator system, *The Journal of Vascular Access* 2005; 6: 9-12.
- Randolph AG et al, Ultrasound guidance for placement of central venous catheters: a meta-analysis of the literature, *Critical Care Medicine*, pp. 2053-2058, vol. 24, Dec. 1996.
- Reece, A et al, Positioning Long Lines: Contrast Versus Plain Radiography, *Arch Dis Child Fetal Neonatal Ed*, pp. 129-130, vol. 84 No. 2, Mar. 2001.
- Reynolds, N et al, Assessment of Distal Tip Position of Long Term Central Venous Feeding Catheters using Transesophageal Echocardiology, *JPEN J Parenter Enteral Nutr*, pp. 39-41, vol. 25 No. 1, Jan.-Feb. 2001.
- RU 2011150917 filed Dec. 15, 2011 First Office Action dated Apr. 24, 2014.
- Ruschulte, Heiner et al, Prevention of Central Venous Catheter related infections with chlorhexidine gluconate impregnated wound dressings: A randomized controlled trial, presented as an abstract at the Annual meeting of the European Society of Anaesthesiologists (ESA) in Madrid, Spain in Jun. 2006, 12 pages, *Annals of Hematology*, Jul. 14, 2008.
- Rutherford, J. S. et al., Depth of Central Venous Catheterization: An Audit of Practice in a Cardiac Surgical Unit, *Anaesth Intens Care* 1994; 22: 267-271.
- Sacolick, et al. "Electromagnetically Tracked Placement of a Peripherally Inserted Central Catheter." *SPIE Medical Imaging, 2004 Proceedings*.
- Salem, et al. "A New Peripherally Implanted Subcutaneous Permanent Central Venous Access Device for Patients Requiring Chemotherapy." *Journal of Clinical Oncology*, vol. 11, No. 11, pp. 2181-2185, Nov. 1993.
- Savary, D et al, Intra-atrial Monitoring to Add Insertion of a Central Venous Line in Pre-Hospital Emergency Care *Journal European des Urgences*, pp. 75-78, vol. 17 No. 2, 2004.
- Schafer et al. "Incorrect placement of a vena cava catheter and its prevention by intra-atrial ECG." *Anaesthesist*. Jan. 1988;37(1):49-51.
- Schummer, et al. "Central Venous Catheters—The inability of 'intra-atrial ECG' to prove adequate positioning." *British Journal of Anaesthesia*, vol. 93, No. 2, pp. 193-198, 2004.
- Schummer, W et al, ECG-guided Central Venous Catheter Positioning: Does it detect the Pericardial Reflection rather than the Right Atrium?, *Eur J Anaesthesiol*, pp. 600-605, vol. 21 No. 8, Aug. 2004 (Abstract only).
- Schummer, W et al, Intra-Atrial ECG is not a Reliable Method for Positioning Left Internal Jugular Vein Catheters, *Br J Anaesth*, pp. 481-486, vol. 91 No. 4, Oct. 2003.
- Schummer, W, Central Venous Catheter—the Inability of "Intra-Atrial ECG" to prove Adequate Positioning, *Br J Anaesth*, pp. 193-198, vol. 93 No. 2, Aug. 2004.
- Schuster, M. et al., The carina as a landmark in central venous catheter placement, *British Journal of Anaesthesia* 85 (2): 192-4 (2000).
- Siela, Debra, Using Chest Radiography in the Intensive Care Unit, *Crit Care Nurse* Aug. 1, 2002 vol. 22 No. 4, pp. 18-27.
- Simon, et al., "Central Venous Catheter Placement in Children: Evaluation of Electrocardiography Using J-Wire." *Paediatric Anaesthesia* vol. 9, pp. 501-504, 1999.
- Smith, Brigham, et al., Intravenous electrocardiographic guidance for placement of peripherally inserted central catheters, *Journal of Electrocardiology* 43 (2010) 274-278.
- Stark, DD et al, Radiographic Assessment of Venous Catheter Position in Children: Value of the Lateral View, *Pediatric Radiology*, pp. 76-80, vol. 14 No. 2, 1984.
- Starkhammar et al. "Cath-Finder Catheter Tracking System: A New Device for Positioning of Central Venous Catheters. Early Experience from Implantation of Brachial portal Systems." *Acta Anaesthesiol Scandinavia*, vol. 34, No. 4 pp. 296-300, May 1990.
- Starkhammar, H et al, Central Venous Catheter Placement using Electromagnetic Position Sensing: A Clinical Evaluation, *Biomed. Instrum Technol*, vol. 30 No. 2, pp. 164-170; Mar.-Apr. 1996.
- Starr, David S et al, EKG Guided Placement of Subclavian CVP Catheters Using J-Wire, pp. 673-676, *Ann. Surg*, Dec. 1986.
- Stas, M et al, Peroperative Intravasal Electrographic Control of Catheter Tip Position in Access Ports Placed by Venous Cut-Down Technique, *EJSO*, pp. 316-320, vol. 27, 2001.
- STEREOTAXIS Magetic Navigation System with Navigant™ User Interface, 2005 Brochure.
- STEREOTAXIS, Expanding the Possibilities of Interventional Medicine: Remote Navigation and Automation, pp. 1-8, Apr. 2011.
- Tepa® Health Innovation PC based ECG System Introduction and Technical Specifications, EKG Master USB, 2 pages, Nov. 2003.
- The FloWire Doppler Guide Wire located <<http://www.volcanocorp.com/products/flowire-doppler-guide-wire.php>>, 2011.
- Traxal Technologies, Tracking Technology website overview: www.traxal.com/rd/rd_classroom_trackingtechnology.htm, last accessed Dec. 1, 2006.
- UAB Health Systems, Arrhythmias, retrieved from <http://www.health.uab.edu/14564/> on Nov. 15, 2007, 12 pages.
- U.S. Appl. No. 11/466,602, filed Aug. 23, 2006 Advisory Action dated Jun. 22, 2009.
- U.S. Appl. No. 11/466,602, filed Aug. 23, 2006 Appeal Board Decision dated Sep. 17, 2012.
- U.S. Appl. No. 11/466,602, filed Aug. 23, 2006 Final Office Action dated Apr. 8, 2010.
- Neurometer® CPT, Frequently Asked Questions. Neurotron, Inc. website: www.neurotron.com/CPTFAQ/html, last accessed Oct. 23, 2006.
- Neurometer® CPT, Products Page. Neurotron, Inc. website: www.neurotron.com/products.html, last accessed Oct. 23, 2006.
- Neurometer® Electrodiagnostic Neuroselective Sensory Nerve Evaluation: Charts, Tables, Documents & Downloads. Neurotron, Inc. website: www.neurotron.com/downloads.html, last accessed Oct. 23, 2006.
- Odd, De et al, Does Radio-opaque Contrast Improve Radiographic localisation of Percutaneous Central Venous Lines?, *Arch Dis Child Fetal Neonatal Ed*, pp. 41-43, vol. 89 No. 1, Jan. 2004.
- Palesty, JA et al, Routine Chest Radiographs Following Central Venous Recatheterization over a Wire are not Justified, *Am J Surg*, pp. 618-621, vol. 176 No. 6, Dec. 1998.
- Paliotti, Roberta P. et al, Intravascular Doppler Technique for Monitoring Renal Venous Blood Flow in Man, *J Nephrol*, pp. 57-62, 2003.
- Parker, K.H. et al, Cardiovascular Fluid Dynamics, Department of Bioengineering, National Heart and Lung Institute, Imperial College of Science, Technology and Medicine, Cardiovascular Haemodynamics, pp. 1-28, Sep. 26, 2005.
- Pawlik, et al., "Central Venous Catheter Placement: Comparison of the Intravascular Guidewire and the Fluid Column Electrocardiograms." *European Journal of Anaesthesiology*, vol. 41, pp. 594-599, 2004.
- PCT/US13/62409 filed Sep. 27, 2013 International Search Report and Written Opinion dated Feb. 24, 2014.
- PCT/US2006/033079 filed Aug. 24, 2006 International Preliminary Report on Patentability dated Feb. 26, 2008.
- PCT/US2006/033079 filed Aug. 24, 2006 Search Report dated Dec. 19, 2006.
- PCT/US2006/033079 filed Aug. 24, 2006 Written Opinion dated Dec. 19, 2006.
- PCT/US2008/060502 filed Apr. 16, 2008 International Search Report and Written Opinion dated Oct. 16, 2008.
- PCT/US2008/084751 filed Nov. 25, 2008 International Preliminary Report on Patentability dated Jun. 1, 2010.
- PCT/US2008/084751 filed Nov. 25, 2008 Search Report dated May 20, 2009.
- PCT/US2008/084751 filed Nov. 25, 2008 Written Opinion dated May 20, 2009.
- PCT/US2009/033116 filed Feb. 4, 2009 International Preliminary Report on Patentability dated Aug. 10, 2010.

(56)

References Cited

OTHER PUBLICATIONS

- PCT/US2009/033116 filed Feb. 4, 2009 Search Report dated Mar. 13, 2009.
- PCT/US2009/033116 filed Feb. 4, 2009 Written Opinion dated Mar. 13, 2009.
- PCT/US2009/041051 filed Apr. 17, 2009 International Preliminary Report on Patentability dated Apr. 8, 2014.
- PCT/US2009/041051 filed Apr. 17, 2009 Search Report dated Jul. 28, 2009.
- PCT/US2009/041051 filed Apr. 17, 2009 Written Opinion dated Jul. 28, 2009.
- PCT/US2009/054687 filed Aug. 21, 2009 International Preliminary Report on Patentability dated Feb. 22, 2011.
- PCT/US2009/054687 filed Aug. 21, 2009 Search Report dated Oct. 6, 2009.
- PCT/US2009/054687 filed Aug. 21, 2009 Written Opinion dated Oct. 6, 2009.
- PCT/US2009/056567 filed Sep. 10, 2009 International Preliminary Report on Patentability dated Mar. 15, 2011.
- PCT/US2009/056567 filed Sep. 10, 2009 Search Report dated Nov. 6, 2009.
- PCT/US2009/056567 filed Sep. 10, 2009 Written Opinion dated Nov. 6, 2009.
- PCT/US2010/038555 filed Jun. 14, 2010 Search Report dated Oct. 5, 2010.
- PCT/US2010/038555 filed Jun. 14, 2010 Written Opinion dated Oct. 5, 2010.
- PCT/US2010/045084 filed Aug. 10, 2010 International Preliminary Report on Patentability dated Feb. 23, 2012.
- PCT/US2010/045084 filed Aug. 10, 2010 Search Report dated Apr. 14, 2011.
- PCT/US2010/045084 filed Aug. 10, 2010 Written Opinion dated Apr. 14, 2011.
- PCT/US2010/050773 filed Sep. 29, 2010 Search Report dated Jan. 24, 2011.
- PCT/US2010/050773 filed Sep. 29, 2010 Written Opinion dated Jan. 24, 2011.
- PCT/US2010/051917 filed Oct. 8, 2010 Search Report dated Nov. 29, 2010.
- PCT/US2010/051917 filed Oct. 8, 2010 Written Opinion dated Nov. 29, 2010.
- PCT/US2011/023497 filed Feb. 2, 2011 Search Report dated Jun. 6, 2011.
- PCT/US2011/023497 filed Feb. 2, 2011 Written Opinion dated Jun. 6, 2011.
- PCT/US2011/038391 filed May 27, 2011 International Preliminary Report on Patentability and Written Opinion dated Dec. 4, 2012.
- PCT/US2011/038391 filed May 27, 2011 International Search Report dated Sep. 21, 2011.
- PCT/US2011/038415 filed May 27, 2011 International Preliminary Report on Patentability dated Dec. 13, 2012.
- PCT/US2011/038415 filed May 27, 2011 International Search Report dated Sep. 28, 2011.
- PCT/US2011/038415 filed May 27, 2011 Written Opinion dated Sep. 28, 2011.
- PCT/US2011/047127 filed Aug. 9, 2011 International Preliminary Report on Patentability dated Apr. 18, 2013.
- PCT/US2011/047127 filed Aug. 9, 2011 International Search Report dated Feb. 29, 2012.
- PCT/US2011/047127 filed Aug. 9, 2011 Written Opinion dated Feb. 29, 2012.
- PCT/US2011/048403 filed Aug. 19, 2011 International Preliminary Report on Patentability dated Jul. 30, 2013.
- PCT/US2011/048403 filed Aug. 19, 2011 International Search Report dated Dec. 15, 2011.
- PCT/US2011/048403 filed Aug. 19, 2011 Written Opinion dated Dec. 15, 2011.
- U.S. Appl. No. 13/118,138, filed May 27, 2011 Non-Final Office Action dated Oct. 3, 2012.
- U.S. Appl. No. 13/213,622, filed Aug. 19, 2011 Final Office Action dated Feb. 19, 2013.
- U.S. Appl. No. 13/213,622, filed Aug. 19, 2011 Non-Final Office Action dated Jul. 31, 2012.
- U.S. Appl. No. 13/213,622, filed Aug. 19, 2011 Non-Final Office Action dated May 22, 2014.
- U.S. Appl. No. 13/283,395, filed Oct. 27, 2011 Non-Final Office Action dated Apr. 23, 2013.
- U.S. Appl. No. 13/336,919, filed Dec. 23, 2011 Advisory Action dated May 23, 2013.
- U.S. Appl. No. 13/336,919, filed Dec. 23, 2011 Final Office Action dated Mar. 1, 2013.
- U.S. Appl. No. 13/336,919, filed Dec. 23, 2011 Non-Final Office Action dated Dec. 27, 2013.
- U.S. Appl. No. 13/336,919, filed Dec. 23, 2011 Non-Final Office Action dated Oct. 16, 2012.
- U.S. Appl. No. 13/337,987, filed Dec. 27, 2011 Non-Final Office Action dated Mar. 15, 2013.
- U.S. Appl. No. 13/469,932, filed May 11, 2012 Non-Final Office Action dated Jan. 3, 2014.
- U.S. Appl. No. 13/469,932, filed May 11, 2012 Non-Final Office Action dated Jul. 31, 2014.
- U.S. Appl. No. 13/665,420, filed Oct. 31, 2012 Non-Final Office Action dated Jan. 6, 2014.
- U.S. Appl. No. 13/737,806, filed Jan. 9, 2013 Notice of Allowance dated Oct. 31, 2013.
- U.S. Appl. No. 13/887,166, filed May 3, 2013 Advisory Action dated Aug. 27, 2014.
- U.S. Appl. No. 13/887,166, filed May 3, 2013 Final Office Action dated Jun. 23, 2014.
- U.S. Appl. No. 13/887,166, filed May 3, 2013 Non-Final Office Action dated Jan. 7, 2014.
- U.S. Appl. No. 13/890,158, filed May 8, 2013 Non-Final Office Action dated Aug. 15, 2014.
- U.S. Appl. No. 13/969,265, filed Aug. 16, 2013 Non-Final Office Action dated Dec. 19, 2013.
- U.S. Appl. No. 13/969,265, filed Aug. 16, 2013 Notice of Allowance dated Jun. 23, 2014.
- U.S. Appl. No. 14/141,046, filed Dec. 26, 2013 Non-Final Office Action dated Jun. 20, 2014.
- U.S. Appl. No. 14/317,501, filed Jun. 27, 2014 Non-Final Office Action dated Sep. 12, 2014.
- U.S. Appl. No. 29/428,649, filed Aug. 1, 2012 Notice of Allowance dated Jul. 5, 2013.
- Valdivieso, J.R. Perez, et al., Evaluation of a formula for optimal positioning of a central venous catheter inserted through the right internal jugular vein, *Rev. Esp. Anestesiol. Reanim.* 2003; 50: 77-79.
- VasoNova Inc, Vascular navigation system for accurate placement of PICCs, Start-Up Emerging Medical Ventures, pp. 44-45, vol. 14 No. 7, Jul.-Aug. 2009.
- Vesely, Thomas M. et al., Central Venous Catheter Tip Position: A Continuing Controversy, *J Vasc Interv Radiol* 2003; 14:527-534.
- VIASYS Health Care Inc. Cortrak® Fact Sheet, 2005.
- VIASYS Healthcare MedSystems, Navigator® Benefits, 2008.
- VIASYS Healthcare MedSystems, Navigator® Research in Cost Justification, 2008.
- VIASYS MedSystems, Cortrak™ Systems Brochure, 2005.
- Volcano ComboMap Features and Benefits/Technical Specifications, 2 pages, 2011.
- Watters, et al. "Use of Electrocardiogram to Position Right Atrial Catheters During Surgery." *Annals of Surgery*, vol. 225, No. 2, pp. 165-171, 1997.
- Welch Allyn Cardioperfect® PC-Based Resting ECG, 2003.
- Wilson, R. G. et al, Right Atrial Electrocardiography in Placement of Central Venous Catheters, *The Lancet*, pp. 462-463, Feb. 27, 1988.
- Wong, Jeffrey J. et al., Azygos Tip Placement for Hemodialysis Catheters in Patients with Superior Vena Cava Occlusion, *Cardiovasc Intervent Radiol* (2006) 29:143-146.
- Worley, Seth J. "Use of a Real-Time Three-Dimensional Magnetic Navigation System for Radiofrequency Ablation of Accessory Pathways." *PACE*, vol. 21 pp. 1636-1643, Aug. 1998.

(56)

References Cited

OTHER PUBLICATIONS

- Yilmazlar A et al, Complications of 1303 Central Venous Cannulations, *J R Soc Med*, pp. 319-321, vol. 90 No. 6, Jun. 1997 (Abstract only).
- Yoon, SZ et al, Usefulness of the Carina as a Radiographic Landmark for Central Venous Catheter Placement in Paediatric Patients, *Br J Anaesth*, Jul. 2005.
- Yoshida, Teruhisa et al, Detection of Concealed Left Sided Accessory Atrioventricular Pathway by P Wave Signal Averaged Electrocardiogram, *J Am Coll Cardiol*, pp. 55-62, 1999.
- Zaaroor, et al. "Novel Magnetic Technology for Intraoperative Intracranial Frameless Navigation: In Vivo and in Vitro Results." *Neurosurgery*, vol. 48, No. 5. pp. 1100-1107, May 2001.
- Zachariou, Zacharias et al., Intra-atrial ECG recording: a new and safe method for implantation of Broviac catheters in children, *Pediatr Surg Int* (1994) 9: 457-458.
- Zaidi, Naveed A., et al. "Room temperature magnetic order in an organic magnet derived from polyaniline." 2004, *Polymer*, vol. 45, pp. 5683-5689.
- 1 Egelhof, Petra, Effects of Somatostatin on Portal Blood Flow and Portal Vein Pressure in Patients with Portal Hypertension due to Liver Cirrhosis Invasive Monitoring during TIPSS Procedures, Dissertation submitted to: Technical University of Munich, Faculty of Medicine, May 13, 2002; Date of examination: Feb. 26, 2003.
- Forauer, AR et al, Change in Peripherally Inserted Central Catheter Tip Location with Abduction and Adduction of the Upper Extremity, *J Vasc Intery Radiol*, pp. 1315-1318, vol. 11 No. 10, Nov.-Dec. 2000.
- Hill, Bradley et al, Abstract of article discussing VasaNova VPS as guide for placement of PICCs.
- Micronix CathRite™ Cardiac Access Device Brochure.
- Neurometer® CPT, Clinical Applications, Neurotron, Inc. website: www.neurotron.com/CLINAPS.html, last accessed Oct. 23, 2006.
- U.S. Appl. No. 11/466,602, filed Aug. 23, 2006 Non-Final Office Action dated Mar. 28, 2013.
- U.S. Appl. No. 11/466,602, filed Aug. 23, 2006 Notice of Allowance dated Dec. 3, 2012.
- U.S. Appl. No. 12/426,175, filed Apr. 17, 2009 Non-Final Office Action dated Dec. 3, 2012.
- U.S. Appl. No. 12/545,762, filed Aug. 21, 2009 Final Office Action dated Mar. 7, 2013.
- U.S. Appl. No. 12/575,456, filed Oct. 7, 2009 Non-Final Office Action dated Oct. 5, 2012.
- U.S. Appl. No. 12/854,083, filed Aug. 10, 2010 Non-Final Office Action dated Jan. 29, 2013.
- U.S. Appl. No. 12/878,915, filed Sep. 9, 2010 Notice of Allowance dated Jan. 8, 2013.
- U.S. Appl. No. 13/118,138, filed May 27, 2011 Final Office Action dated Apr. 3, 2013.
- U.S. Appl. No. 13/336,919, filed Dec. 23, 2013 Advisory Action date May 23, 2013.
- U.S. Appl. No. 13/336,919, filed Dec. 23, 2011 final Office Action dated March 1, 2013.
- Stereotaxis, Expanding the Possibilities of Interventional Medicine: Remote Navigation and Automation, pp. 1-8.
- Traxal Technologies, Tracking Technology website overview: www.traxal.com/rd/rd_classroom_trackingtechnology.htm, last accessed Dec. 1, 2006.
- U.S. Appl. No. 11/466,602, filed Aug. 23, 2006 Final Office Action dated Jan. 30, 2009.
- U.S. Appl. No. 11/466,602, filed Aug. 23, 2006 Non-Final Office Action dated Sep. 25, 2009.
- U.S. Appl. No. 11/552,094, filed Oct. 23, 2006 Notice of Allowability dated Apr. 2, 2010.
- U.S. Appl. No. 11/552,094, filed Oct. 23, 2006 Non-Final Office Action dated Apr. 27, 2009.
- U.S. Appl. No. 11/552,094, filed Oct. 23, 2006 Notice of Allowance dated May 20, 2010.
- U.S. Appl. No. 12/369,625, filed Feb. 11, 2009 Non-Final Office Action dated Jul. 20, 2011.
- U.S. Appl. No. 12/427,244, filed Apr. 21, 2009 Non-Final Office Action dated Jan. 19, 2012.
- VIASYS Health Care Inc. Cortrak® Fact Sheet.
- VIASYS MedSystems, Cortrak™ Systems Brochure.
- Volcano ComboMap Features and Benefits/Technical Specifications, 2 pages.
- Anonymous author, Correct Catheter Placement with a low-impact, reliable and economical method, <<http://www.cvcpartner.com/index.cfm?103A955CC6844BF58ACFE3C9C1471959>>, last accessed Dec. 22, 2011.
- Arrow International, Inc., The Arrow-Johans RAECG Adapter—Making Proper Central Venous Catheter Placement More Reliable (Modle No. EG-04900), Technical Report 1987, USA.
- Aurora® System Technical Specifications 2004.
- B. Braun, Certofix Central Venous Catheter for Placement Using the Seldinger Technique with Simultaneous ECG Lead Option.
- Buehrle, Douglas, PICC Placement in Humans using Electromagnetic Detection, <http://www.corpakmedsystems.com/supplement_material/supplementpages/navigator/navarticle.html>, 2008.
- C.R. Bard, CathTrack™ Catheter Location System at www.bardaccess.com <<http://www.bardaccess.com>>.
- Chu, et al., "Accurate Central Venous Port-A Catheter Placement: Intravenous Electrocardiography and Surface Landmark Techniques Compared by Using Transesophageal Echocardiography." *The International Anesthesia Research Society*, vol. 98, pp. 910-914, 2004.
- Clifford, et al. "Assessment of Hepatic Motion Secondary to Respiration for Computer Assisted Interventions." *Computer Aided Surgery*, vol. 7, pp. 291-299, 2002.
- ComboWire® Pressure/Flow Guide Wire Ref 9500 Series, 36 pages, (information in different languages).
- U.S. Appl. No. 12/104,253, filed Apr. 16, 2008 Final Office Action dated Jul. 27, 2011.
- U.S. Appl. No. 12/104,253, filed Apr. 16, 2008 Non-Final Office Action dated Nov. 29, 2010.
- U.S. Appl. No. 12/323,273, filed Nov. 25, 2008 Non-Final Office Action dated Jun. 8, 2012.
- U.S. Appl. No. 12/369,625, filed Feb. 11, 2009 Final Office Action dated Feb. 23, 2012.
- U.S. Appl. No. 12/557,401, filed Sep. 10, 2009 Non-Final Office Action dated Apr. 24, 2012.
- U.S. Appl. No. 12/878,915, filed Sep. 9, 2010 Non-Final Office Action dated Mar. 15, 2012.
- U.S. Appl. No. 12/815,331, filed Jun. 14, 2010 Non-Final Office Action dated Jan 22, 2013.
- U.S. Appl. No. 12/815,331, filed Jun. 14, 2010 Non-Final Office Action dated Jul. 2, 2014.
- U.S. Appl. No. 12/854,083, filed Aug. 10, 2010 Advisory Action dated Sep. 8, 2014.
- U.S. Appl. No. 12/854,083, filed Aug. 10, 2010 Final Office Action dated Aug. 15, 2013.
- U.S. Appl. No. 12/854,083, filed Aug. 10, 2010 Final Office Action dated Jul. 1, 2014.
- U.S. Appl. No. 12/854,083, filed Aug. 10, 2010 Non-Final Office Action dated Jan. 29, 2014.
- U.S. Appl. No. 12/893,916, filed Sep. 29, 2010 Advisory Action dated Aug. 15, 2014.
- U.S. Appl. No. 12/893,916, filed Sep. 29, 2010 Final Office Action dated Jun. 18, 2014.
- U.S. Appl. No. 12/893,916, filed Sep. 29, 2010 Non-Final Office Action dated Dec. 24, 2013.
- U.S. Appl. No. 12/900,750, filed Oct. 8, 2010 Non-Final Office Action dated Jun. 3, 2013.
- U.S. Appl. No. 13/019,939, filed Feb. 2, 2011 Final Office Action dated Apr. 2, 2014.
- U.S. Appl. No. 13/019,939, filed Feb. 2, 2011 Non-Final Office Action dated Oct. 11, 2013.
- U.S. Appl. No. 13/118,033, filed May 27, 2011 Non-Final Office Action dated Aug. 1, 2013.
- U.S. Appl. No. 13/118,033, filed May 27, 2011 Non-Final Office Action dated May 22, 2014.

(56)

References Cited

OTHER PUBLICATIONS

Popp, M. B. et al., Accuracy of implanted port placement with the use of the electromagnetic CathTrack® catheter locator system, *The Journal of Vascular Access* 2005; 6: 9-12.

U.S. Appl. No. 12/369,625, filed Feb. 11, 2009 Notice of Allowance dated Oct. 5, 2012.

U.S. Appl. No. 12/545,762, filed Aug. 21, 2009 Non-Final Office Action dated Aug. 1, 2012.

U.S. Appl. No. 12/715,556, filed Mar. 2, 2010 Non-Final Office Action dated Sep. 13, 2012.

U.S. Appl. No. 12/878,915, filed Sep. 9, 2010 Final Office Action dated Sep. 26, 2012.

References from U.S. Appl. No. 13/240,171 Information Disclosure Statement, filed May 21, 2012.

U.S. Appl. No. 11/466,602, filed Aug. 23, 2006 Final Office Action dated Oct. 28, 2013.

U.S. Appl. No. 11/466,602, filed Aug. 23, 2006 Notice of Allowance dated Mar. 14, 2014.

U.S. Appl. No. 12/426,175, filed Apr. 17, 2009 Advisory Action dated Nov. 26, 2013.

U.S. Appl. No. 12/426,175, filed Apr. 17, 2009 Final Office Action dated Aug. 2, 2013.

U.S. Appl. No. 12/426,175, filed Apr. 17, 2009 Final Office Action dated Jan. 31, 2014.

U.S. Appl. No. 12/545,762, filed Aug. 21, 2009 Non-Final Office Action dated Dec. 13, 2013.

U.S. Appl. No. 12/557,401, filed Sep. 10, 2009 Non-Final Office Action dated Jan. 6, 2014.

U.S. Appl. No. 12/715,556, filed Mar. 2, 2010 Final Office Action dated Oct. 2, 2013.

U.S. Appl. No. 12/815,331, filed Jun. 14, 2010 Advisory Action dated Oct. 4, 2013.

U.S. Appl. No. 12/815,331, filed Jun. 14, 2010 Final Office Action dated Jul. 26, 2013.

U.S. Appl. No. 12/815,331, filed Jun. 14, 2010 Non-Final Office Action dated Jan. 22, 2013.

CN 201180052587.5 filed Apr. 28, 2013 Second Office Action dated Aug. 19, 2015.

CN 201180068309.9 filed Aug. 22, 2013 Third Office Action dated Sep. 2, 2015.

EP 10821193.9 filed Mar. 27, 2012 Partial European Search Report dated Oct. 9, 2015.

EP 11787515.3 filed Dec. 12, 2012 partial European search report dated Oct. 27, 2015.

EP 11787527.8 filed Dec. 19, 2012 Extended European Search Report dated Oct. 9, 2015.

U.S. Appl. No. 12/545,762, filed Aug. 21, 2009 Non-Final Office Action dated Sep. 11, 2015.

U.S. Appl. No. 12/893,916, filed Sep. 29, 2010 Non-Final Office Action dated Sep. 10, 2015.

U.S. Appl. No. 13/469,932, filed May 11, 2012 Non-Final Office Action dated Sep. 4, 2015.

U.S. Appl. No. 14/270,241, filed May 5, 2014 Notice of Allowance dated Oct. 7, 2015.

U.S. Appl. No. 14/309,511, filed Jun. 19, 2014 Non-Final Office Action, dated Sep. 24, 2015.

U.S. Appl. No. 14/317,501, filed Jun. 27, 2014 Advisory Action dated Sep. 16, 2015.

U.S. Appl. No. 14/506,552, filed Oct. 3, 2014 Non-Final Office Action dated Oct. 1, 2015.

CA 2,721,715 filed Apr. 17, 2009 Examiner's Report dated Aug. 18, 2015.

CN 200980144663.8 filed May 9, 2011 Fifth Office Action dated May 26, 2015.

CN 201080035659.0 filed Feb. 10, 2012 Third Office Action dated Mar. 19, 2015.

CN 201080053838.7 filed May 28, 2012 Fourth Office Action dated Jun. 2, 2015.

CN 201180037065.8 filed Jan. 28, 2013 First Office Action dated Jun. 2, 2015.

CN 201180037068.1 filed Jan. 28, 2013 First Office Action dated Apr. 20, 2015.

CN 201180043512.0 filed Mar. 8, 2013 Second Office Action dated Apr. 14, 2015.

CN 201180052587.5 filed Apr. 28, 2013 First Office Action dated Jan. 26, 2015.

CN 201180068309.9 filed Aug. 22, 2013 Second Office Action dated May 6, 2015.

EP 11787515.3 filed Dec. 12, 2012 partial European search report dated Jun. 23, 2015.

EP 11787527.8 filed Dec. 19, 2012 partial European search report dated May 26, 2015.

EP 11837113.7 filed May 28, 2013 Extended European Search Report dated Apr. 24, 2014.

EP 12177438.4 filed Jul. 23, 2012 European Search Report dated Jun. 7, 2015.

EP14197136.6 filed Dec. 10, 2014 Extended European Search Report dated May 26, 2015.

JP 2012-515222 filed Dec. 9, 2011 Office Action dated Feb. 23, 2015.

JP 2013-512046 filed Nov. 26, 2012 First Office Action dated Mar. 23, 2015.

JP 2013-512051 filed Nov. 26, 2012 First Office Action dated Mar. 23, 2015.

JP 2013-524999 filed Jan. 22, 2013 First Office Action dated Jun. 1, 2015.

MX/a/2012/013672 filed Nov. 23, 2012 First Office Action dated Aug. 10, 2015.

U.S. Appl. No. 1/118,033, filed May 27, 2011 Non-Final Office Action dated Jul. 8, 2015.

U.S. Appl. No. 12/815,331, filed Jun. 14, 2010 Non-Final Office Action dated Jun. 1, 2015.

U.S. Appl. No. 12/854,083, filed Aug. 10, 2010 Final Office Action dated Aug. 21, 2015.

U.S. Appl. No. 12/854,083, filed Aug. 10, 2010 Non-Final Office Action dated Mar. 16, 2015.

U.S. Appl. No. 13/283,395, filed Oct. 27, 2011 Advisory Action dated Jan. 28, 2014.

U.S. Appl. No. 13/283,395, filed Oct. 27, 2011 Final Office Action dated Nov. 14, 2013.

U.S. Appl. No. 13/665,420, filed Oct. 31, 2012 Non-Final Office Action dated Jul. 9, 2015.

U.S. Appl. No. 13/890,158, filed May 8, 2013 Non-Final Office Action dated Jul. 9, 2015.

U.S. Appl. No. 14/270,241, filed May 5, 2014 Non-Final Office Action dated Apr. 23, 2015.

U.S. Appl. No. 14/449,061, filed Jul. 31, 2014 Non-Final Office Action dated Apr. 27, 2015.

U.S. Appl. No. 14/548,151, filed Nov. 19, 2014 Non-Final Office Action dated Jun. 5, 2015.

CN 201180037068.1 filed Jan. 28, 2013 Third Office Action dated Oct. 19, 2015.

CN 201180040151.4 filed Feb. 19, 2013 Third Office Action dated Dec. 10, 2015.

JP 2012-552060 filed Aug. 1, 2012 Second Office Action dated Nov. 6, 2015.

JP 2013-512046 filed Nov. 26, 2012 Decision of Rejection dated Dec. 8, 2015.

U.S. Appl. No. 12/545,762, filed Aug. 21, 2009 Non-Final Office Action dated Feb. 16, 2016.

U.S. Appl. No. 12/815,331, filed Jun. 14, 2010 Final Office Action dated Nov. 4, 2015.

U.S. Appl. No. 12/854,083, filed Aug. 10, 2010 Non-Final Office Action dated Feb. 1, 2016.

U.S. Appl. No. 14/141,046, filed Dec. 26, 2013 Non-Final Office Action dated Nov. 5, 2015.

U.S. Appl. No. 14/201,300, filed Mar. 7, 2014 Non-Final Office Action dated Jan. 6, 2016.

U.S. Appl. No. 14/449,061, filed Jul. 31, 2014 Final Office Action dated Nov. 6, 2015.

U.S. Appl. No. 14/498,887, filed Sep. 26, 2014 Non-Final Office Action dated Feb. 19, 2016.

(56)

References Cited

OTHER PUBLICATIONS

CN 201180037065.8 filed Jan. 28, 2013 Fourth Office Action dated May 5, 2016.
JP2013-530322 filed Mar. 18, 2013, Office Action dated May 2, 2016.
RU 2013158008 filed Dec. 26, 2013 First Office Action dated May 27, 2016.
U.S. Appl. No. 12/893,916, filed Sep. 29, 2010 Advisory Action dated Jun. 2, 2016.
CN 201180037065.8 filed Jan. 28, 2013 Office Action dated Nov. 24, 2015.
CN 201280033189.3 filed Jan. 3, 2014 Office Action dated Apr. 3, 2014.
CN 201280033189.3 filed Jan. 3, 2014 Office Action dated Sep. 14, 2015.
CN 201410009216.4 filed Jan. 8, 2014 Office Action dated Sep. 25, 2015.
EP 09743249.6 filed Oct. 18, 2010 Extended European Search Report dated Jan. 13, 2016.
EP 11740309/ filed Aug. 23, 2012 Extended European Search Report dated Aug. 3, 2015.
EP 15179061.5 filed Jul. 30, 2015 Extended European Search Report dated Jan. 14, 2016.
JP2013-530322 filed Mar. 18, 2013, Office Action dated Jul. 31, 2015.
MX/a/2013/001317 filed Jan. 31, 2013 Office Action dated Nov. 26, 2015.
U.S. Appl. No. 12/893,916, filed Sep. 29, 2010 Final Office Action dated Mar. 25, 2016.
U.S. Appl. No. 13/118,033, filed May 27, 2011 Final Office Action dated Apr. 1, 2016.
U.S. Appl. No. 13/118,138, filed May 27, 2011 Final Office Action dated Apr. 1, 2016.
U.S. Appl. No. 13/469,932, filed May 11, 2012 Final Office Action dated Apr. 7, 2016.
U.S. Appl. No. 13/665,420, filed Oct. 31, 2012 Final Office Action dated Apr. 8, 2016.
U.S. Appl. No. 14/040,205, filed Sep. 27, 2013 Non-Final Office Action dated Mar. 10, 2016.
U.S. Appl. No. 14/449,061, filed Jul. 31, 2014 Notice of Allowance dated Apr. 13, 2016.
CN 200880012117.4 filed Apr. 16, 2008 Fourth Office Action dated Sep. 4, 2011.
JP 2010-504220 filed Sep. 3, 2009 Office Action dated Apr. 1, 2014.
JP 2010-504220 filed Sep. 3, 2009 Office Action dated Apr. 18, 2013.
JP 2013-512046 filed Nov. 26, 2012 Office Action dated May 16, 2016.
JP 2014-519081 filed Dec. 27, 2013 First Office Action dated Apr. 26, 2016.
KR 10-2012-7000866 filed Jan. 11, 2012 First Office Action dated Jun. 16, 2016.
U.S. Appl. No. 12/369,625, filed Feb. 11, 2009 Notice of Panel Decision dated Aug. 1, 2012.
U.S. Appl. No. 13/337,987, filed Dec. 27, 2011 Examiner's Answer dated Jul. 2, 2014.

U.S. Appl. No. 13/337,987, filed Dec. 27, 2011 Final Office Action dated Sep. 19, 2013.
U.S. Appl. No. 13/469,932, filed May 11, 2012 Advisory Action dated Jun. 27, 2016.
U.S. Appl. No. 13/858,782, filed Apr. 8, 2013 Notice of Allowance dated Oct. 9, 2014.
U.S. Appl. No. 14/141,046, filed Dec. 26, 2013 Final Office Action dated May 11, 2016.
U.S. Appl. No. 14/201,300, filed Mar. 7, 2014 Advisory Action dated Jul. 18, 2016.
U.S. Appl. No. 14/201,300, filed Mar. 7, 2014 Final Office Action dated May 5, 2016.
U.S. Appl. No. 14/317,501, filed Jun. 27, 2014 Examiners Answer dated Jul. 30, 2016.
U.S. Appl. No. 14/498,887, filed Sep. 26, 2014 Final Office Action dated Jun. 15, 2016.
U.S. Appl. No. 14/548,151, filed Nov. 19, 2014 Advisory Action dated Jul. 22, 2016.
CN 201180037065.8 filed Jan. 28, 2013 Notice of Grant dated Aug. 30, 2016.
U.S. Appl. 12/893,916 filed Sep. 29, 2010, Non-Final Office Action dated Aug. 31, 2016.
US 13/336,919 filed Dec. 23, 2011, Notice of Allowance dated Jul. 26, 2016.
US 13/890,158 filed May 8, 2013, Advisory Action dated Jul. 26, 2016.
US 14/141,046 filed Dec. 26, 2013, Advisory Action dated Aug. 4, 2016.
US 14/201,300 filed Mar. 7, 2014, Non-Final Office Action dated Aug. 24, 2016.
US 14/309,511 filed Jun. 19, 2014, Notice of Allowance, dated Jul. 26, 2016.
US 14/498,887 filed Sep. 26, 2014, Advisory Action dated Aug. 22, 2016.
AU 2012278809 filed Nov. 12, 2013 Notice of Acceptance dated Sep. 13, 2016.
CA 2,721,715 filed Apr. 17, 2009 Examiner's Report dated Oct. 25, 2016.
EP 13840356.3 filed Apr. 27, 2015 Partial European Search Report dated Oct. 19, 2016.
EP 13846380.7 filed May 15, 2015 Partial European Search Report dated Sep. 30, 2016.
KR 10-2012-7000866 filed Jan. 11, 2012 Second Office Action dated Nov. 3, 2016.
PCT/US2016/039356 filed Jun. 24, 2016 International Search Report and Written Opinion dated Sep. 16, 2016.
U.S. Appl. No. 12/426,175, filed Apr. 17, 2009 Decision on Appeal dated Nov. 7, 2016.
U.S. Appl. No. 12/545,762, filed Aug. 21, 2009 Non-Final Office Action dated Sep. 26, 2016.
U.S. Appl. No. 13/118,033, filed May 27, 2011 Notice of Allowance dated Sep. 2, 2016.
U.S. Appl. No. 14/040,205, filed Sep. 27, 2013, Final Office Action dated Oct. 19, 2016.
U.S. Appl. No. 14/054,700, filed Oct. 15, 2013, Final Office Action dated Oct. 19, 2016.
U.S. Appl. No. 14/548,151, filed Nov. 19, 2014, Non-Final Office Action dated Sep. 28, 2016.

* cited by examiner

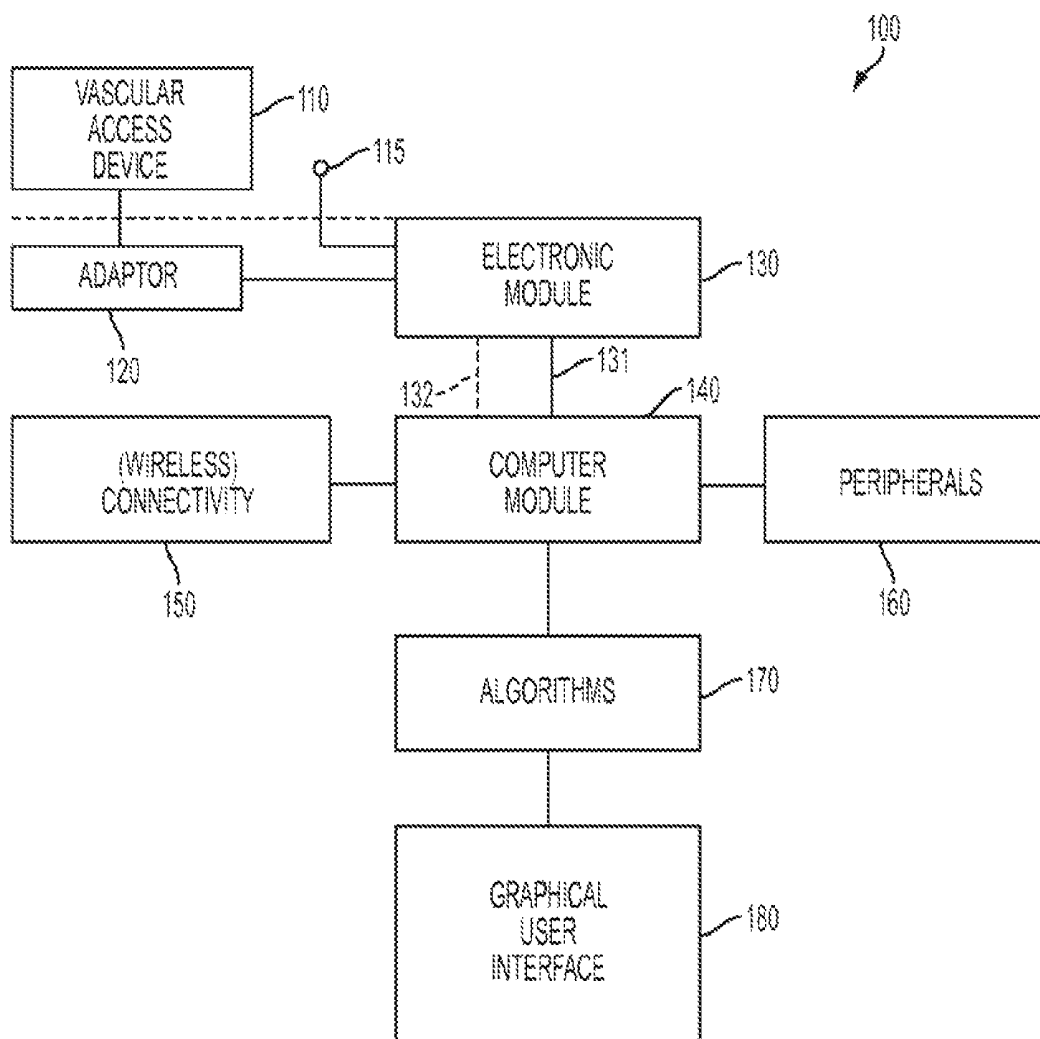

FIG. 1A

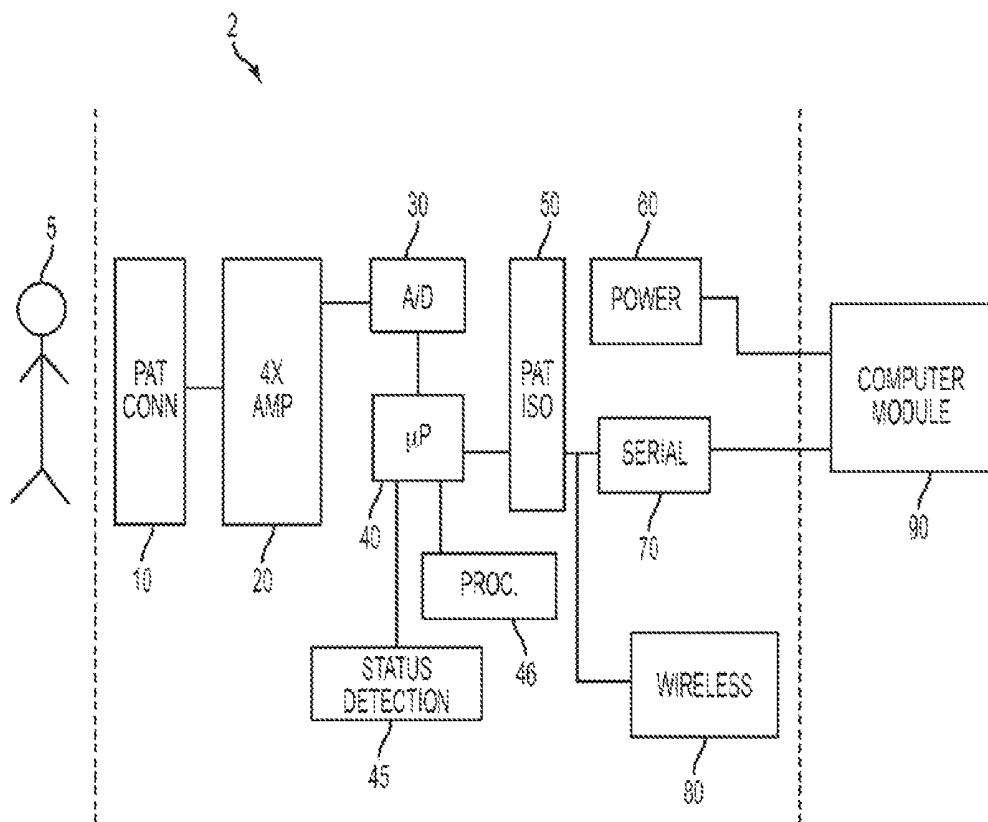

FIG. 1B

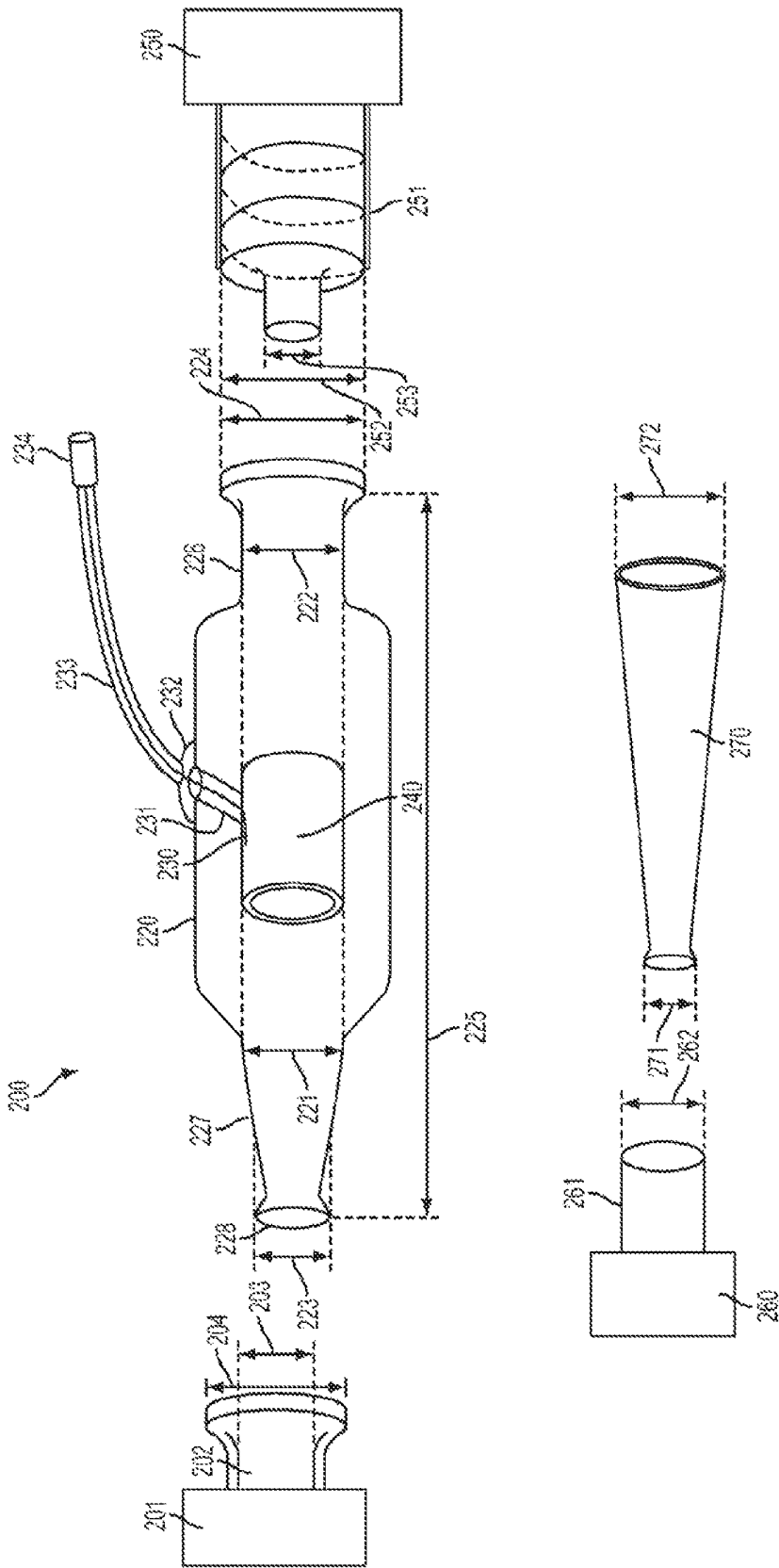

FIG. 2

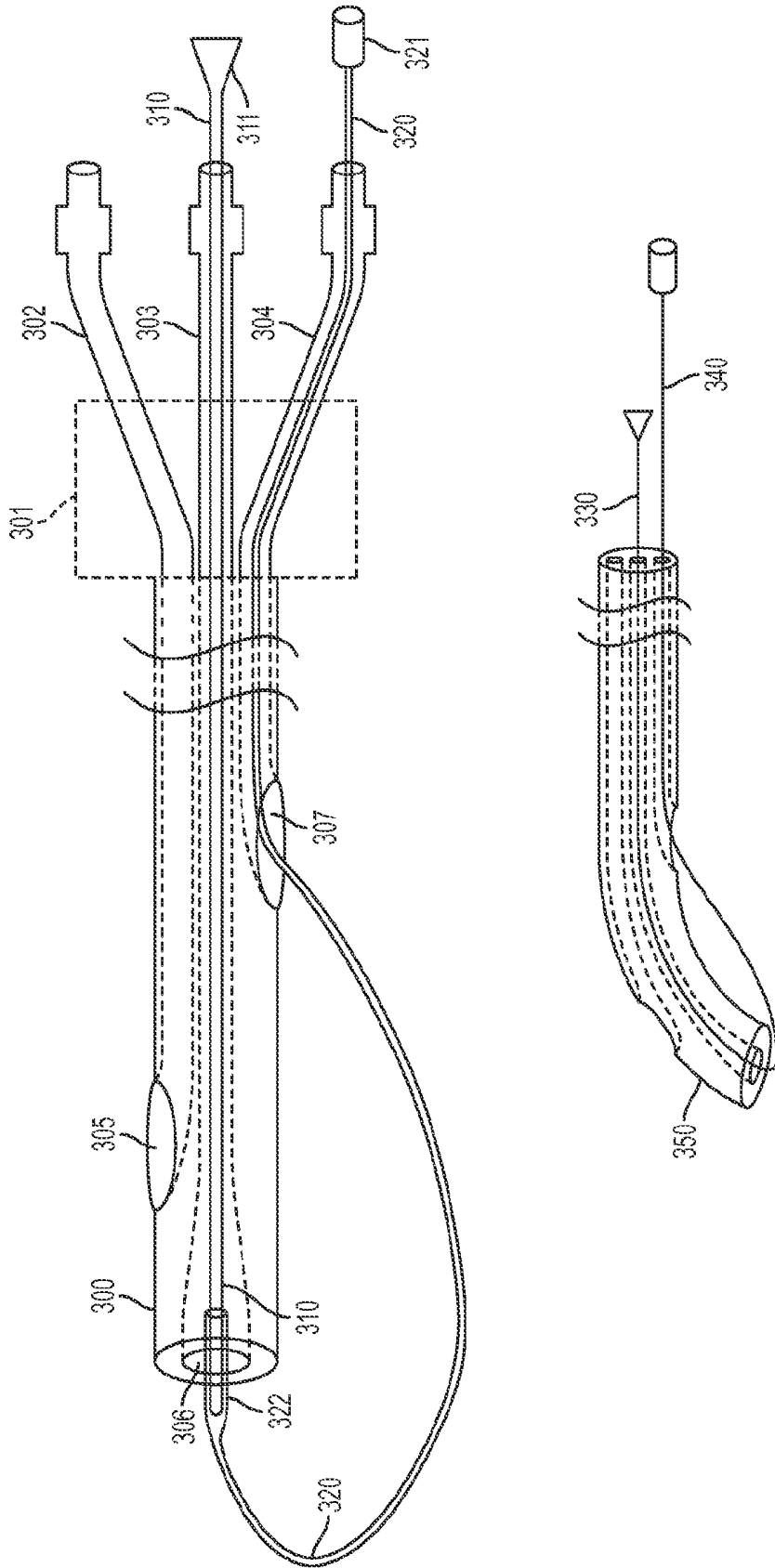

FIG. 3

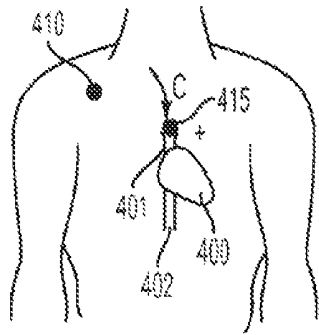

FIG. 4A

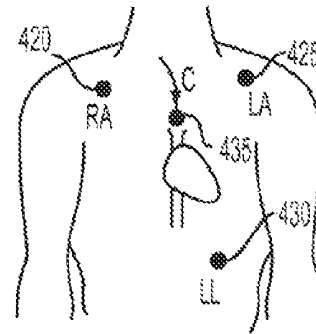

FIG. 4B

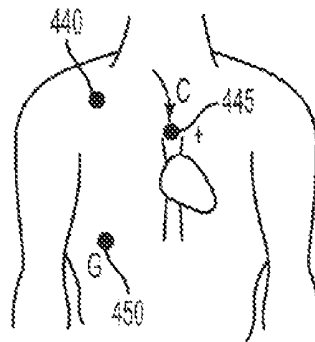

FIG. 4C

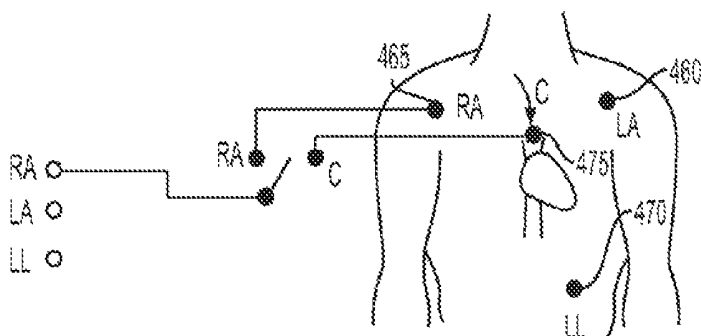

FIG. 4D

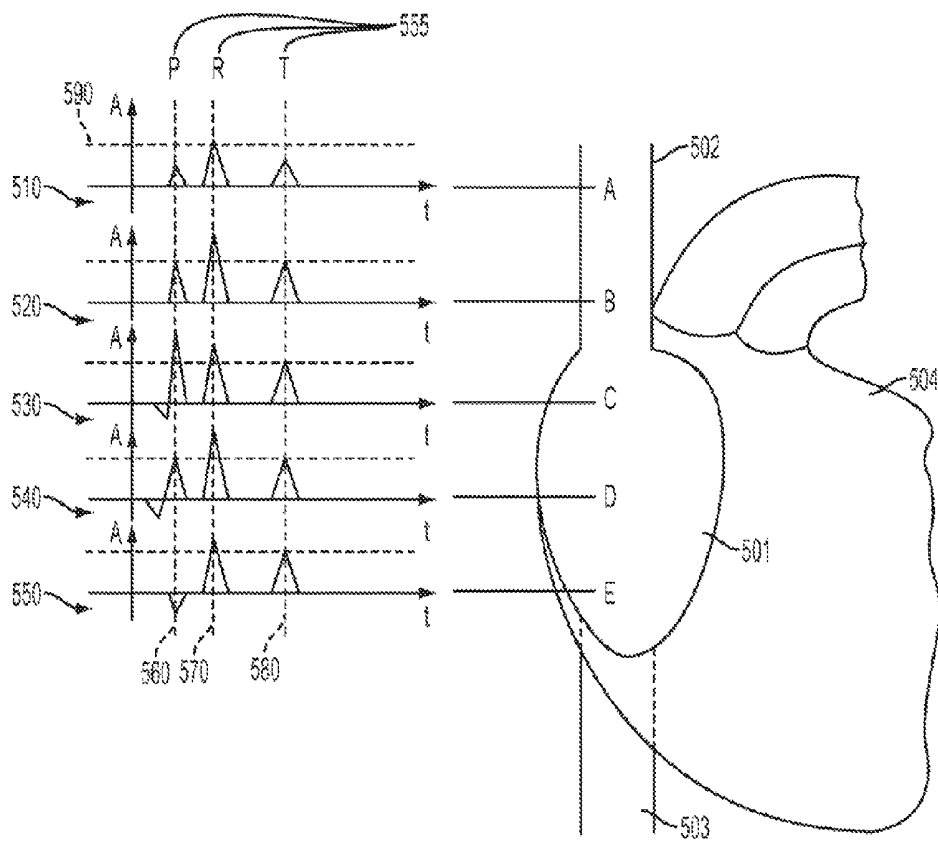

FIG. 5

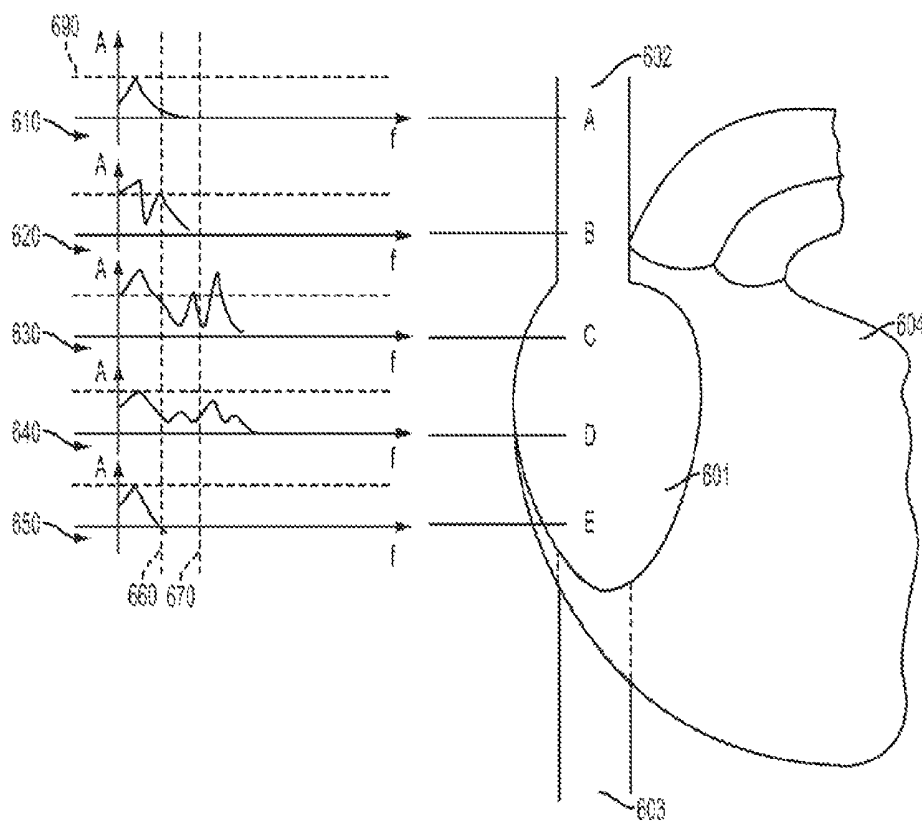

FIG. 6

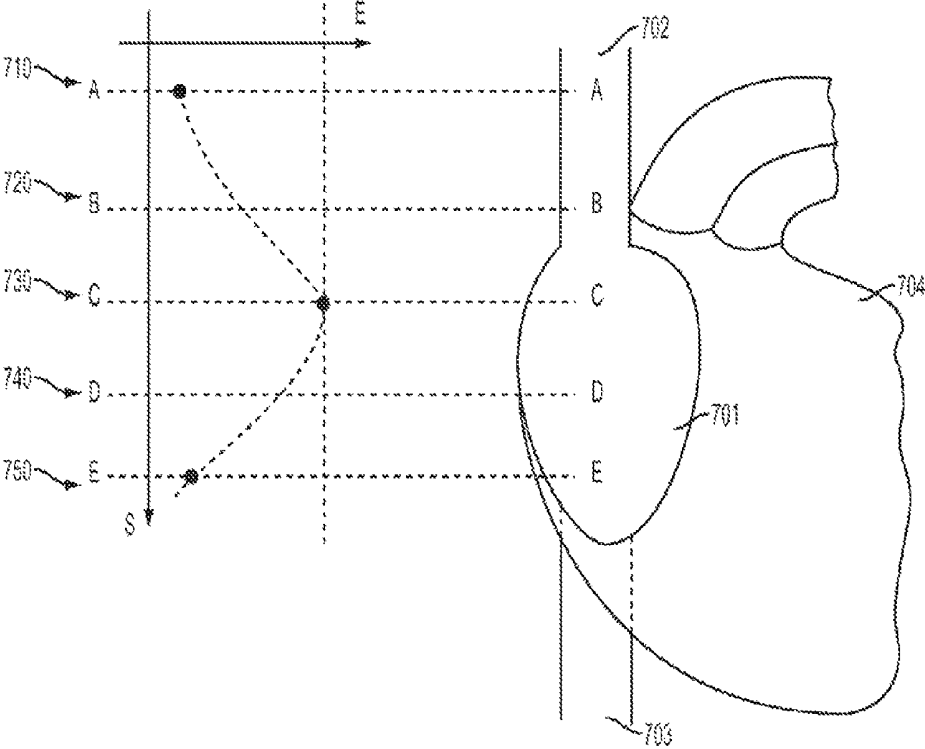

FIG. 7

Sheet 9 of 46

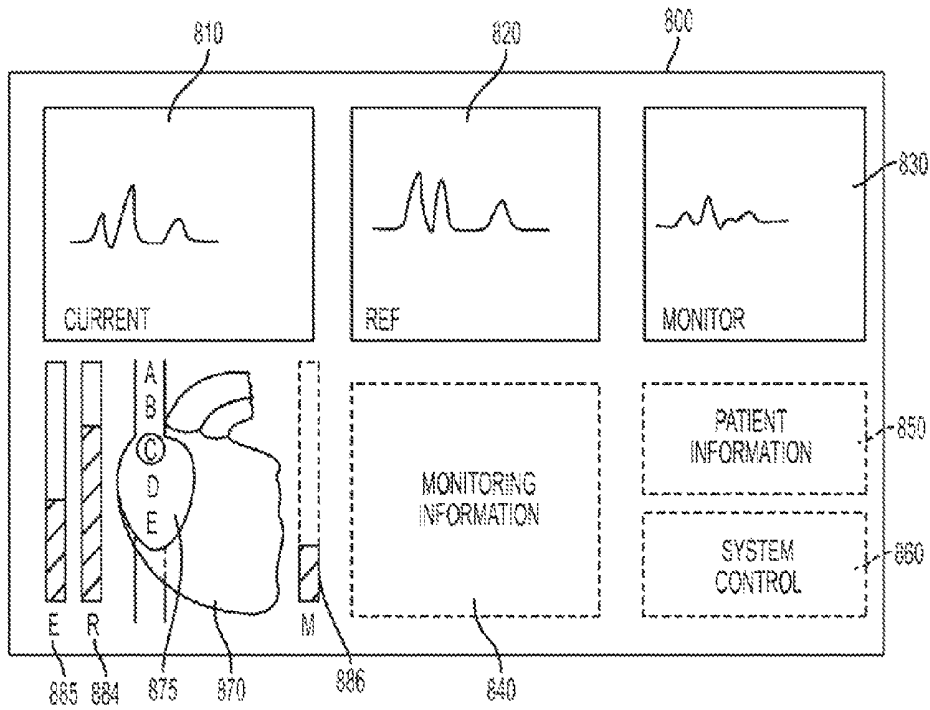

FIG. 8

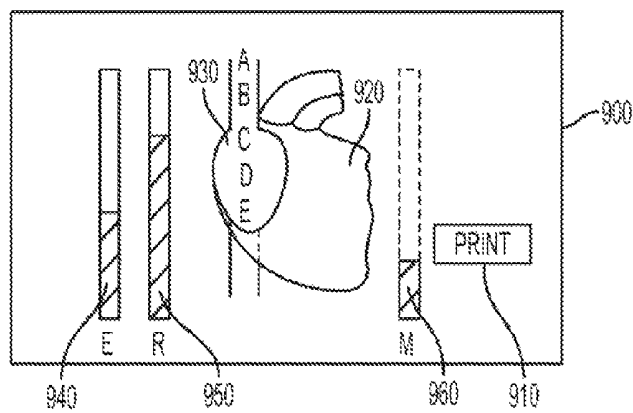

FIG. 9

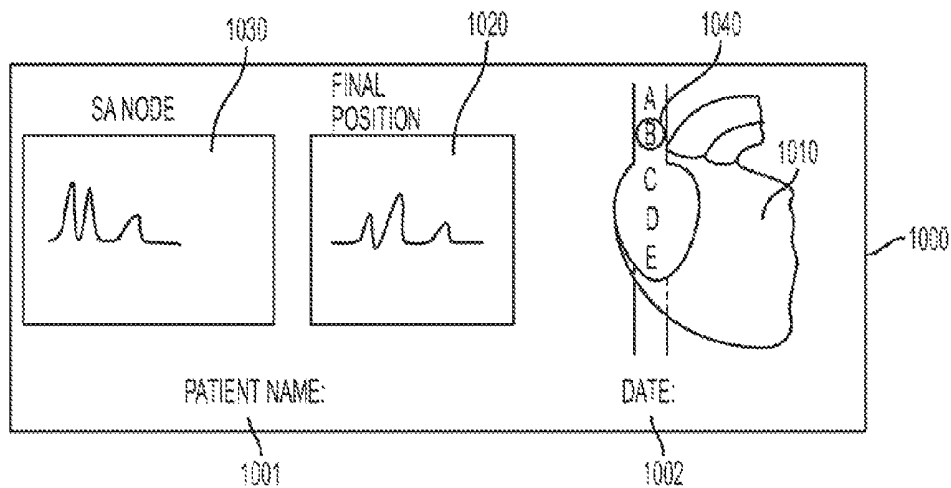

FIG. 10A

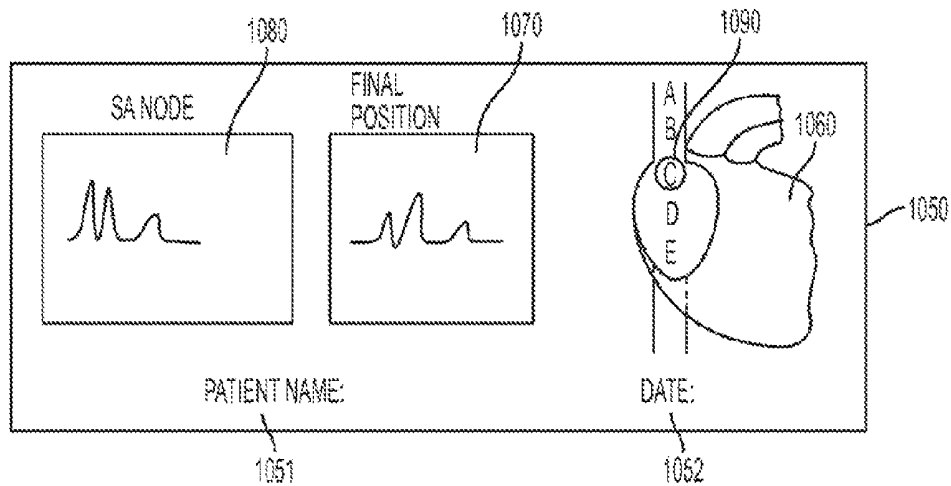

FIG. 10B

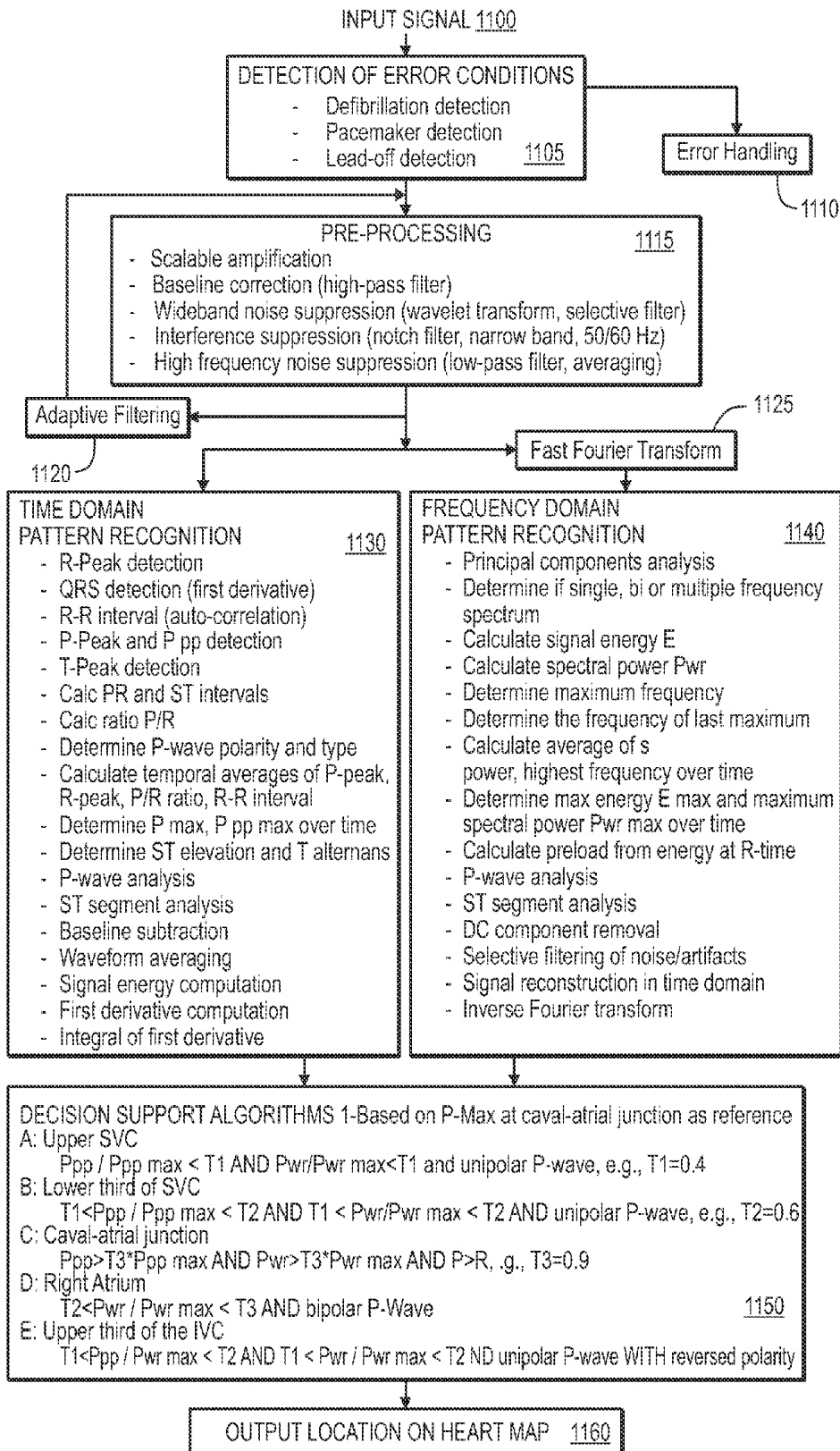

FIG. 11

1250

DECISION SUPPORT ALGORITHMS 1 - Based on skin ECG as reference

A: Upper SVC

$T1 < P_{pp} / P_{pp} \text{ skin} < T2$ AND $T1 < P_{wr} / P_{wr} \text{ skin} < T2$ and unipolar P-wave, e.g., $T1 = 0.9, T2 = 1.2$

B: Lower third of SVC

$T3 < P_{pp} / P_{pp} \text{ skin} < T4$ AND $T3 < P_{wr} / P_{wr} \text{ skin} < T4$ AND unipolar P-wave, e.g., $T3 = 1.5, T4 = 2$

C: Caval-atrial junction

$P_{pp} > T5 * P_{pp} \text{ skin}$ AND $P_{wr} > T5 * P_{wr} \text{ skin}$ AND $P > R$, e.g., $T5 = 2.5$

D: Right atrium

$T6 < P_{wr} / P_{wr} \text{ skin} < T7$ AND bipolar P-wave, e.g., $T6 = 2, T7 = 2.5$

E: Upper third of the IVC

$T1 < P_{pp} / P_{pp} \text{ skin} < T2$ AND $T1 < P_{wr} / P_{wr} \text{ skin} < T2$ AND unipolar P-wave WITH reversed polarity

FIG. 12

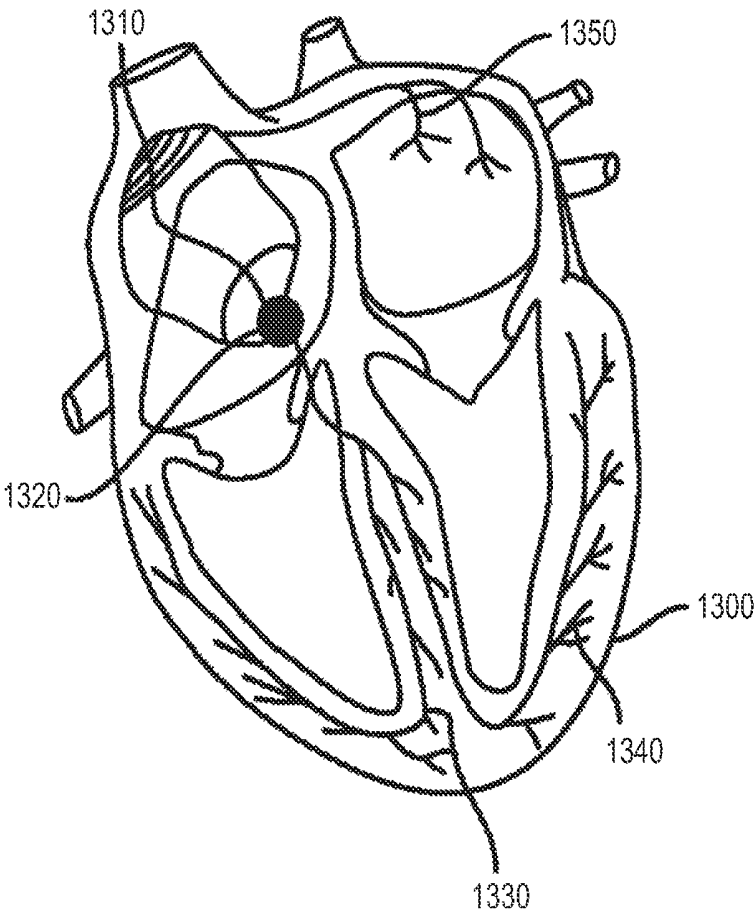

FIG. 13

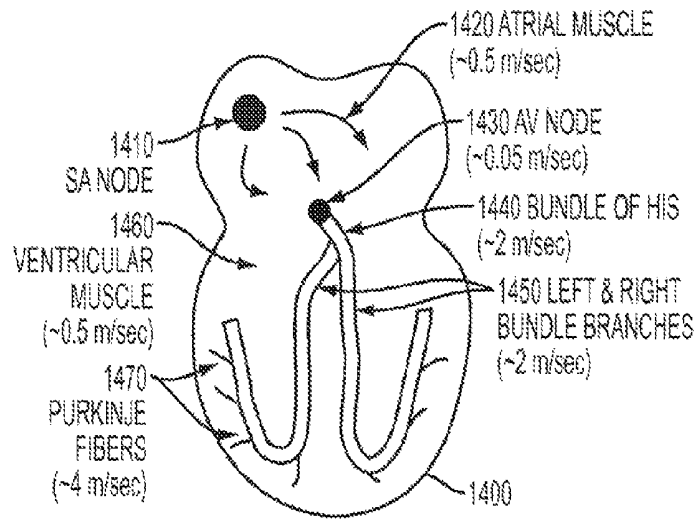

FIG. 14

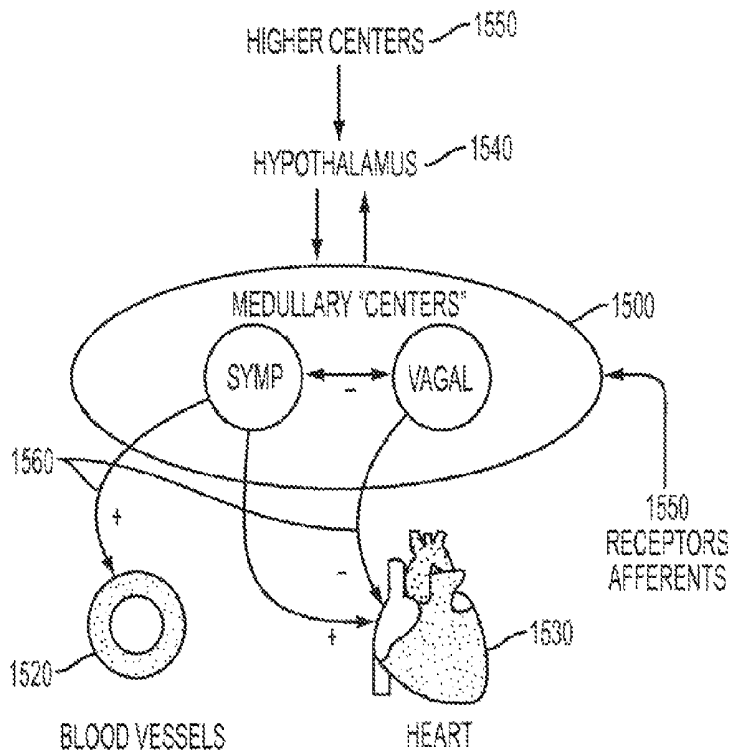

FIG. 15

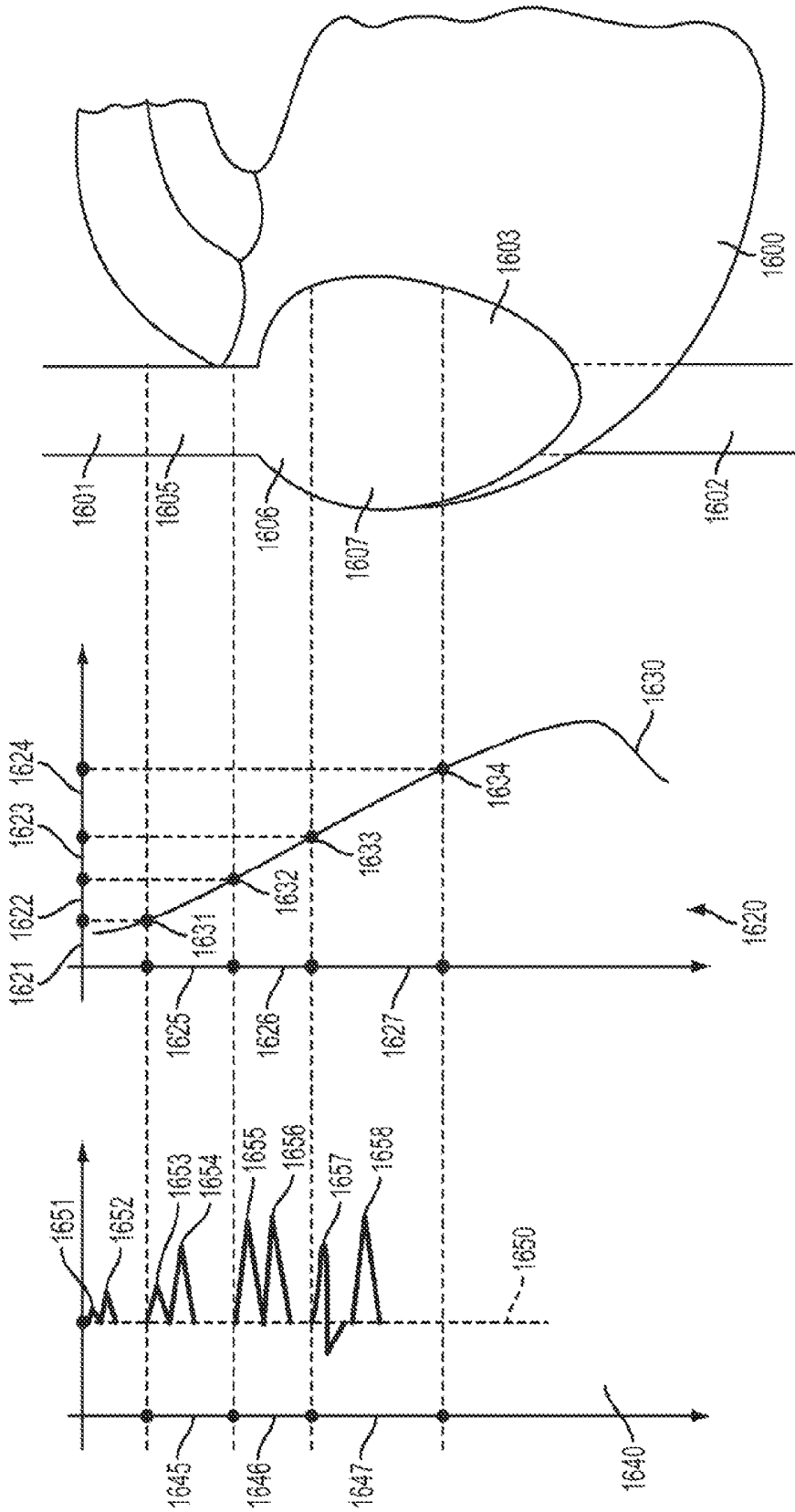

FIG. 16

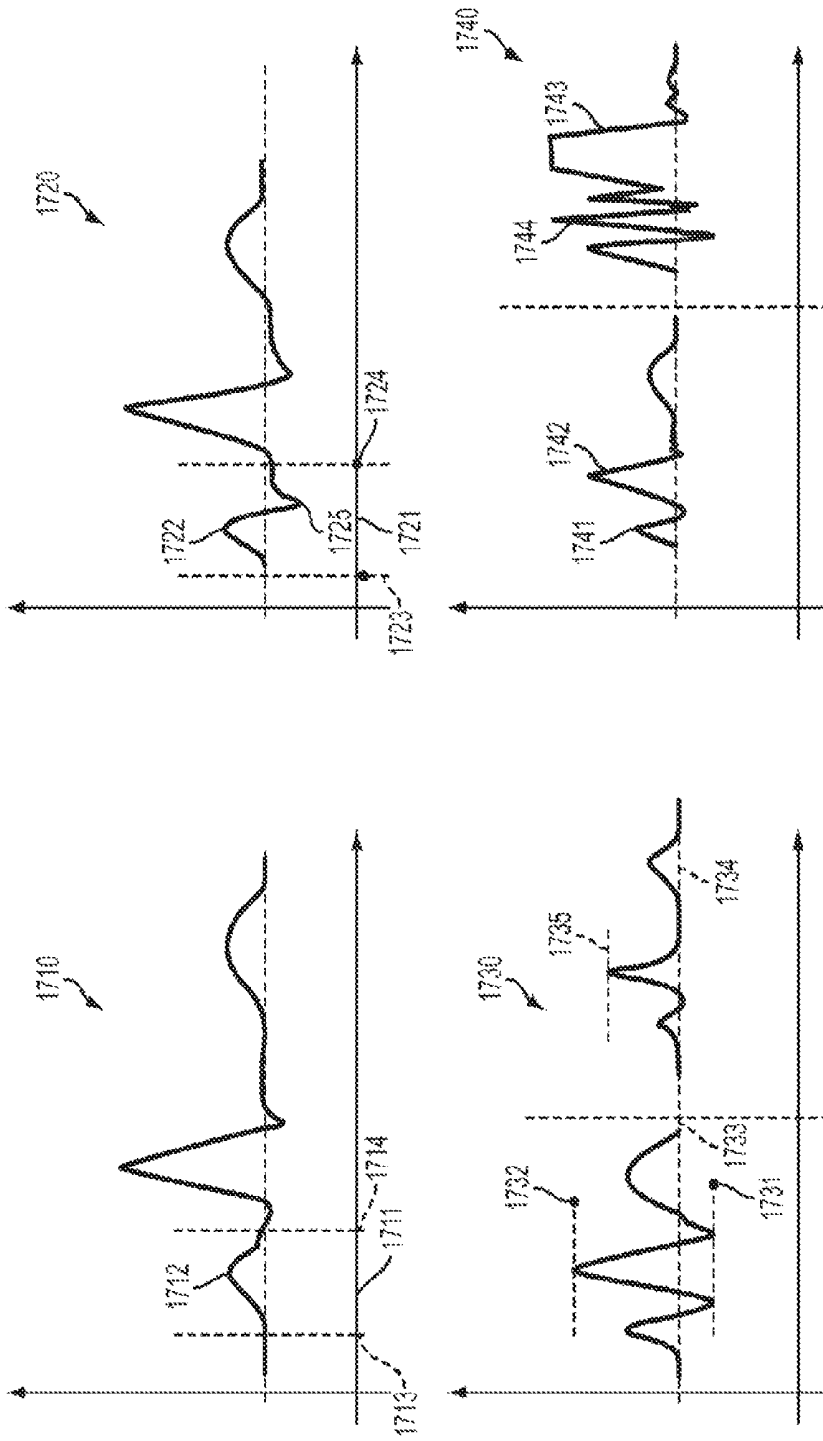

FIG. 17

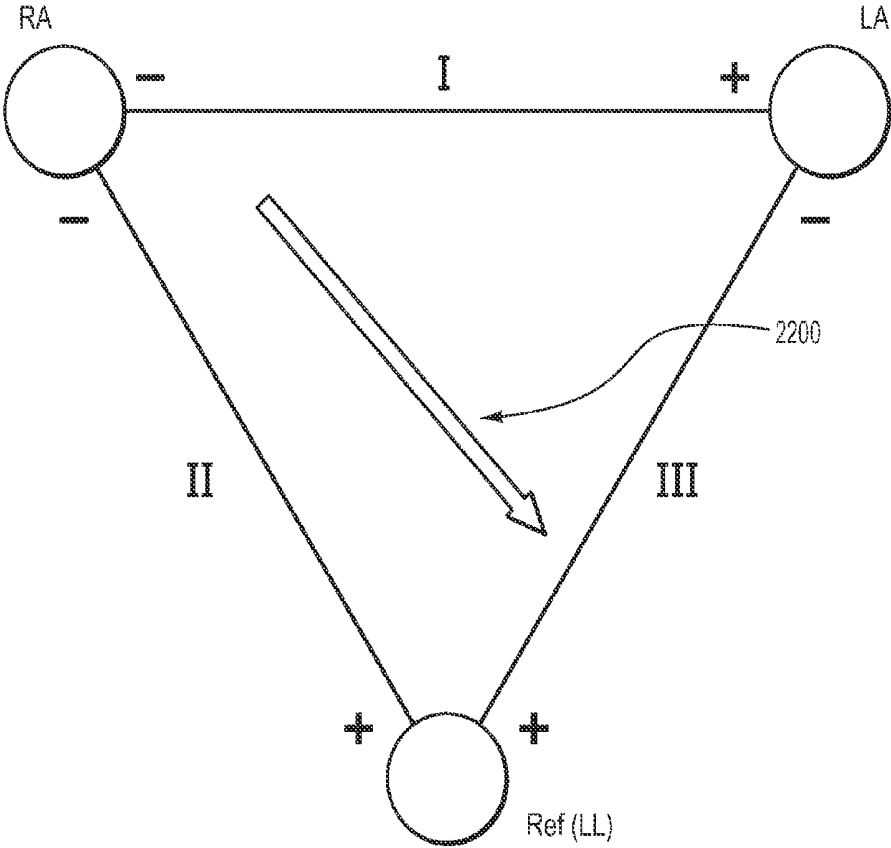

FIG. 18A

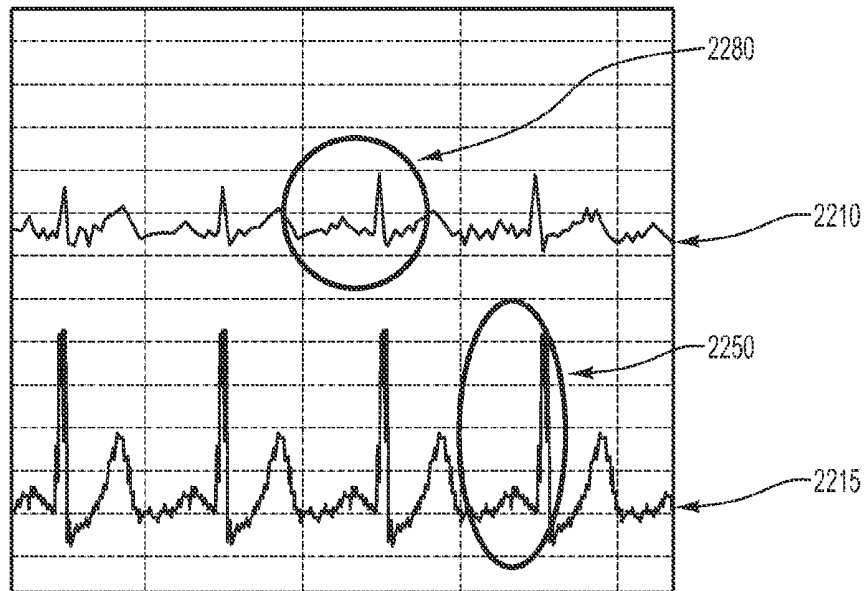

FIG. 18B

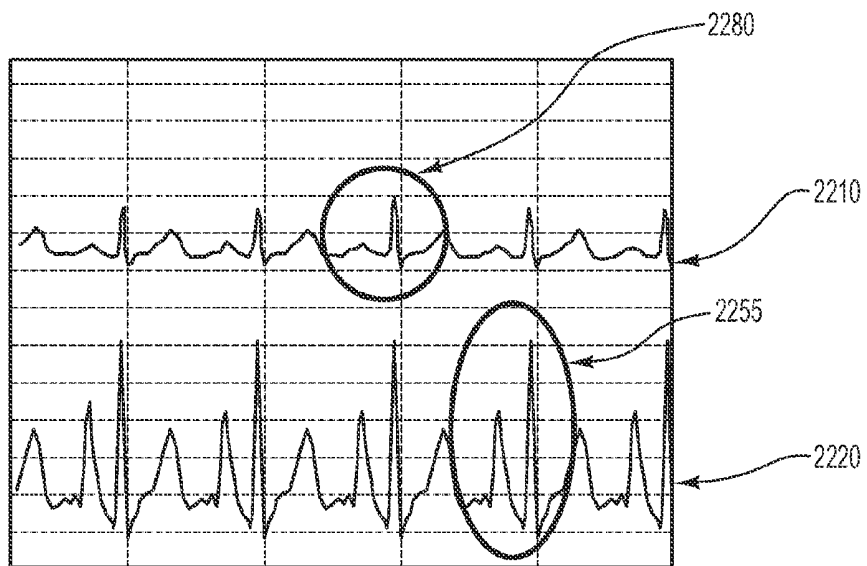

FIG. 18C

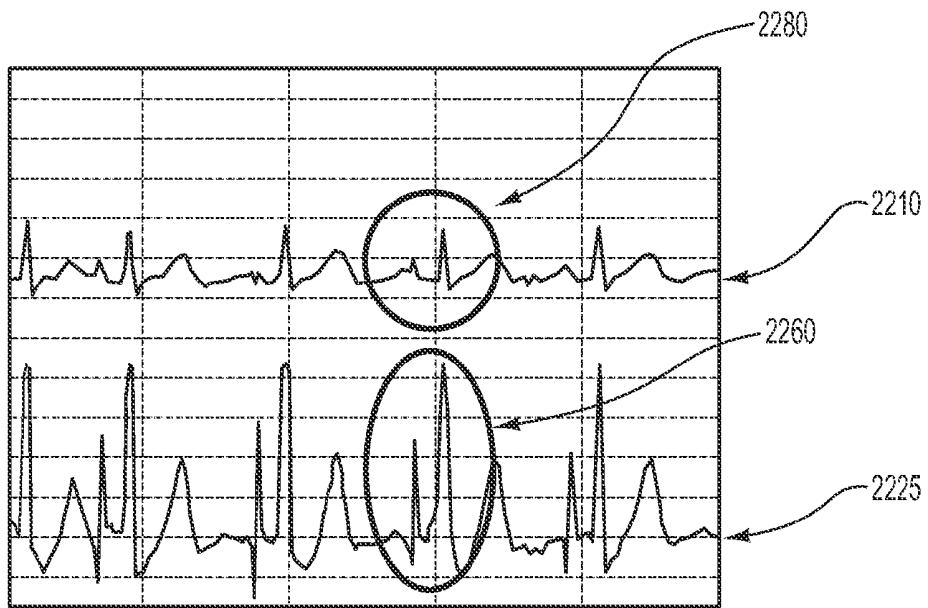

FIG. 18D

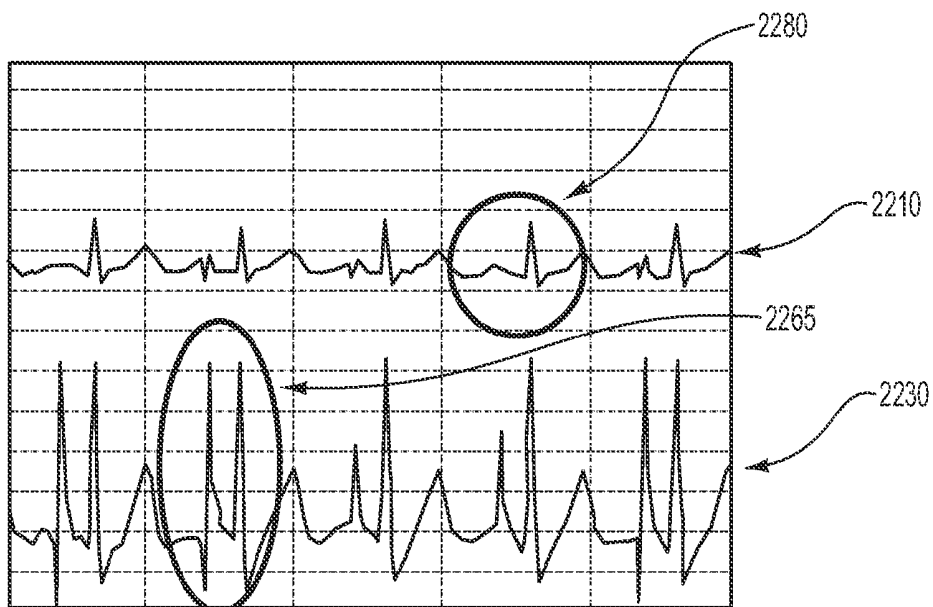

FIG. 18E

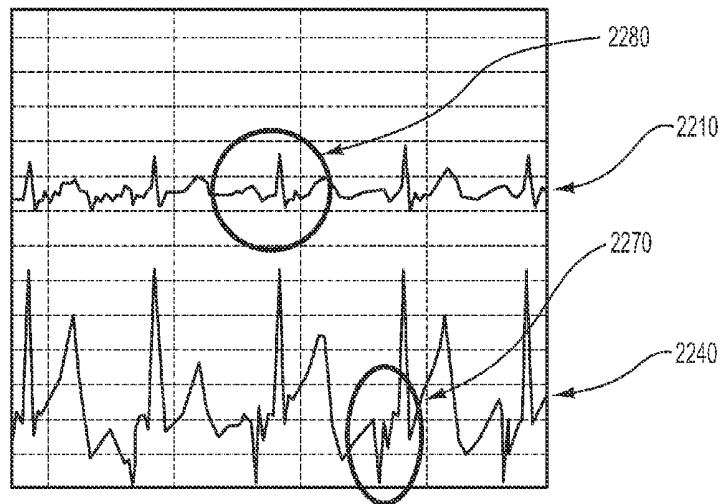

FIG. 18F

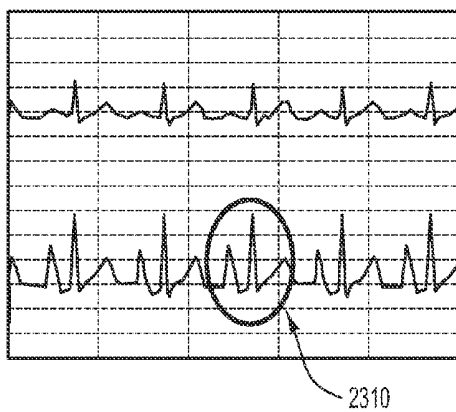

FIG. 19A



FIG. 19B

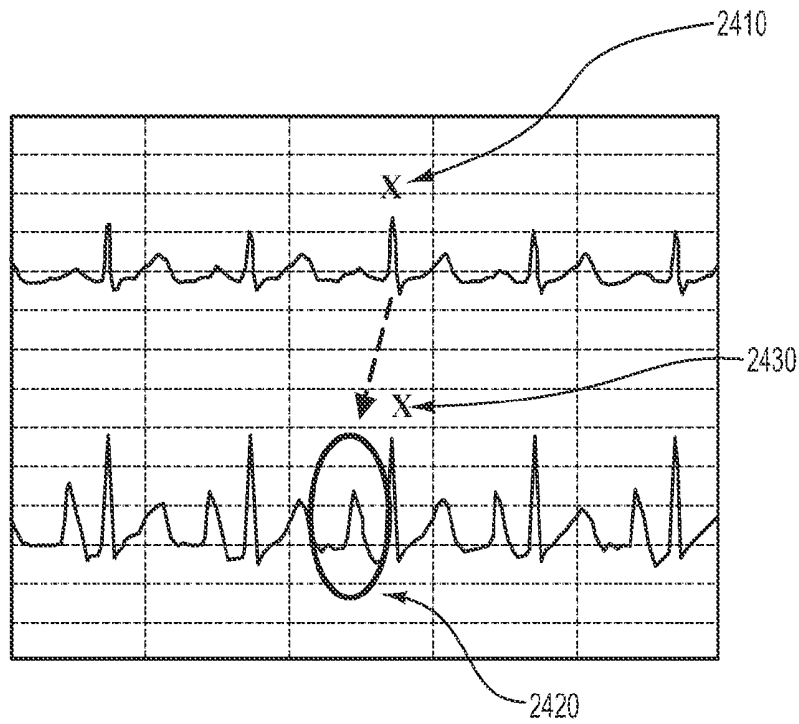

FIG. 20A

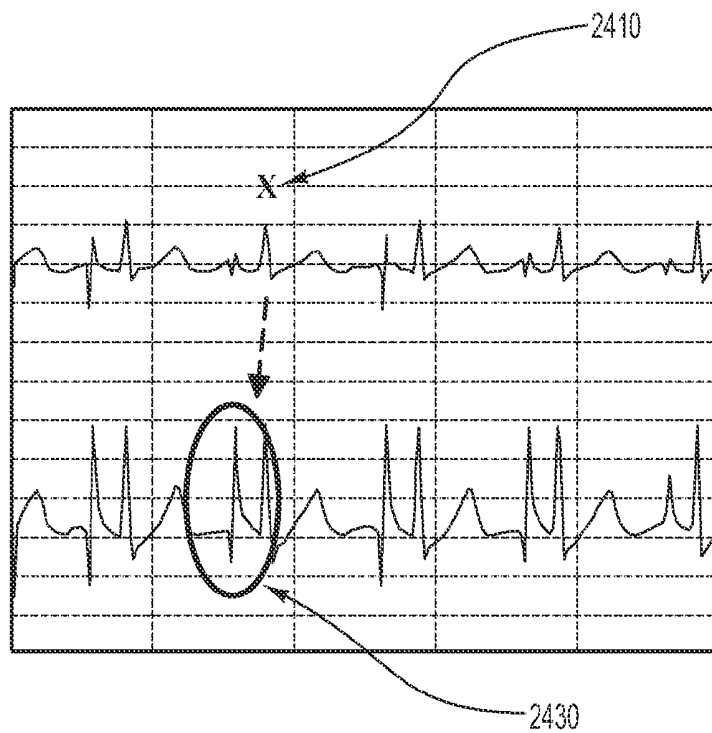

FIG. 20B

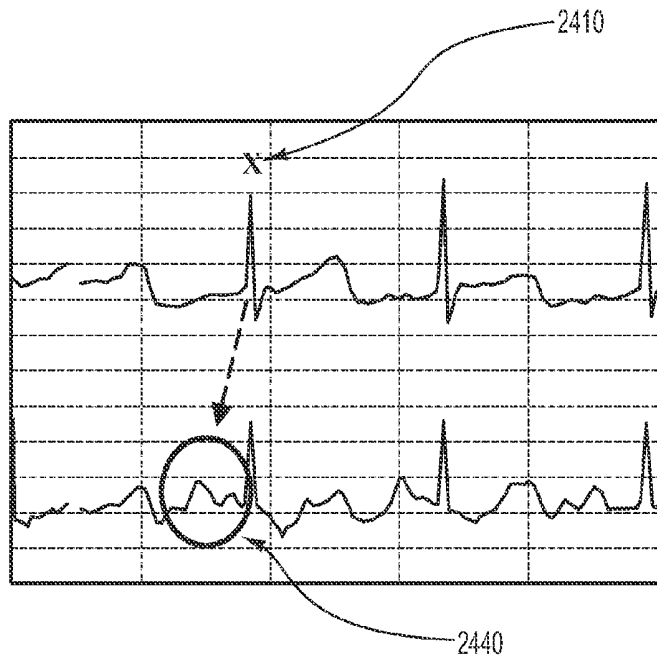

FIG. 20C

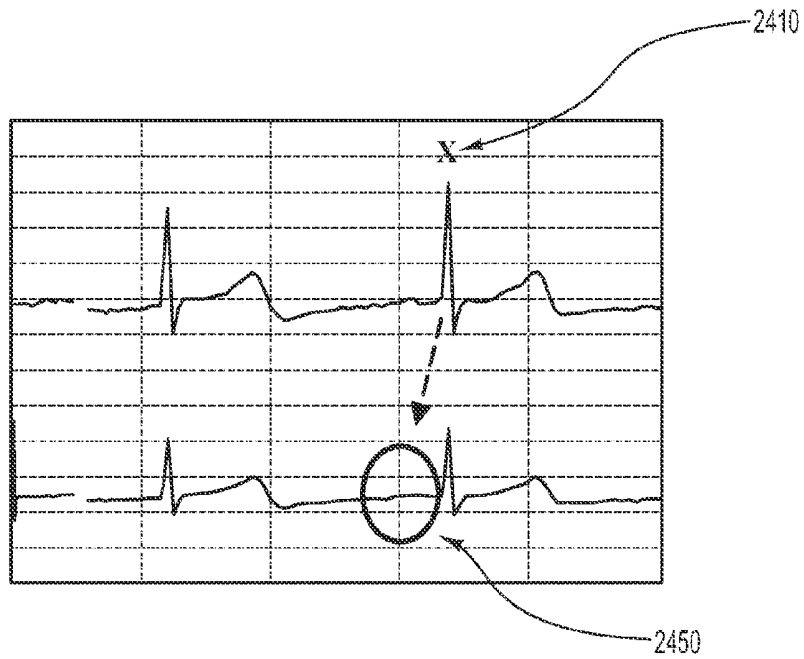

FIG. 20D

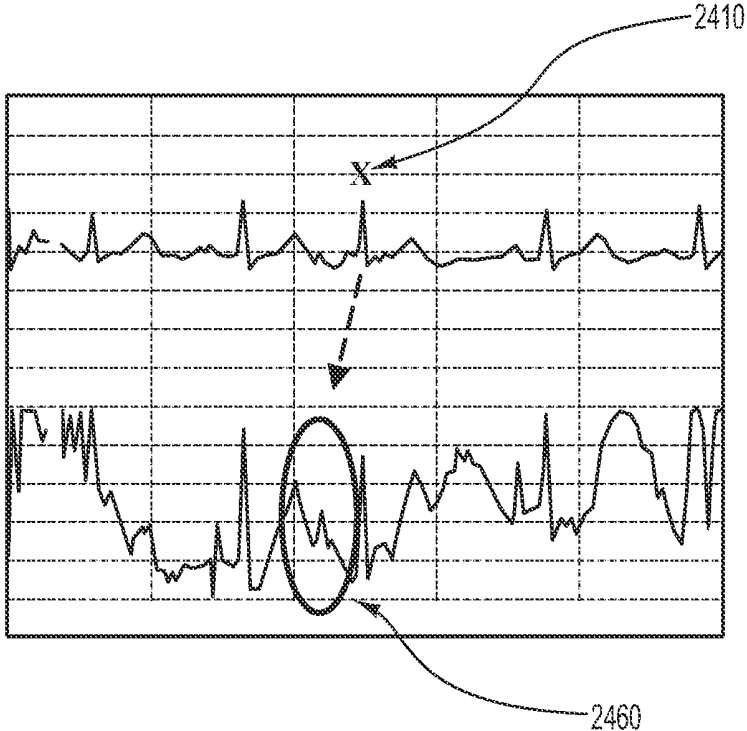

FIG. 20E

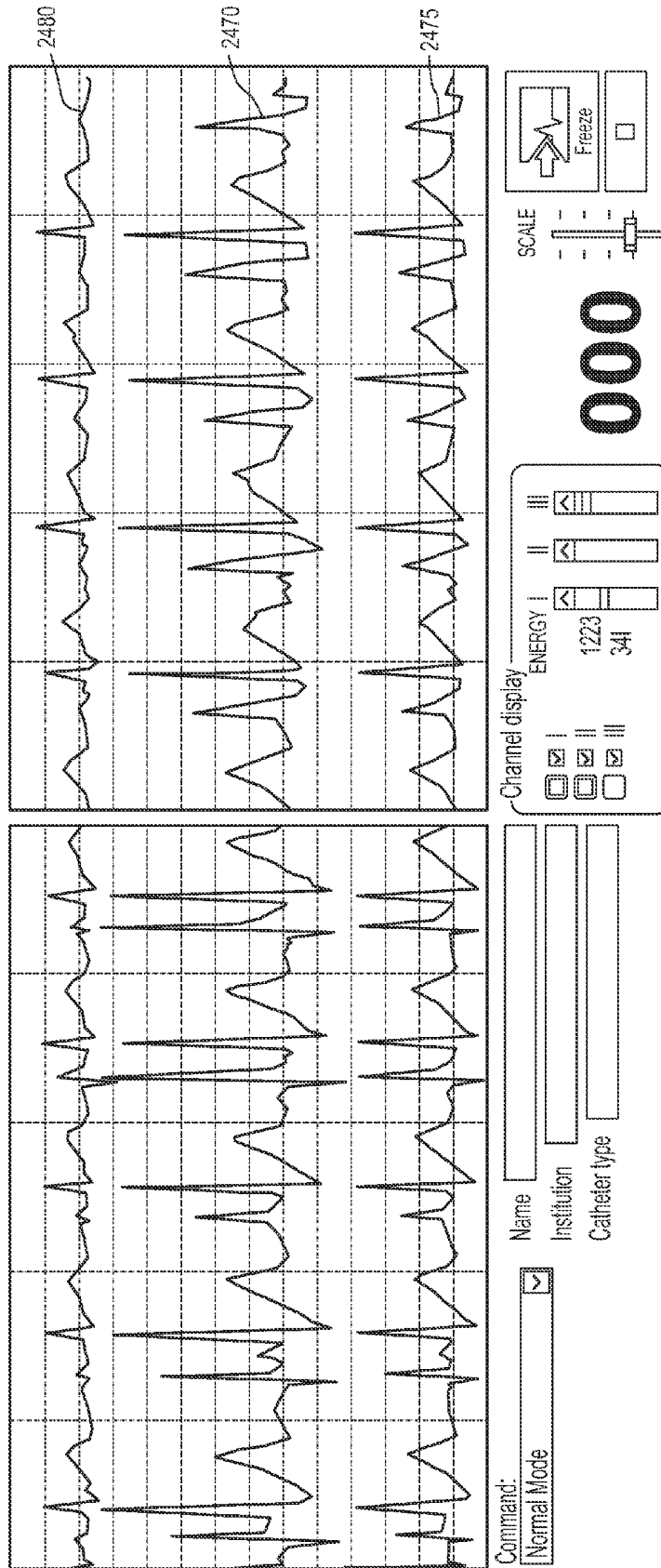

FIG. 20F

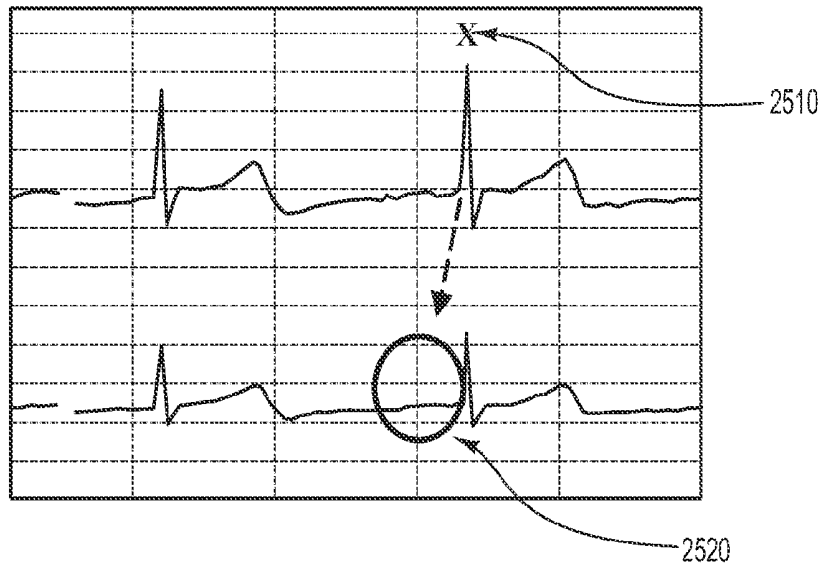

FIG. 21A

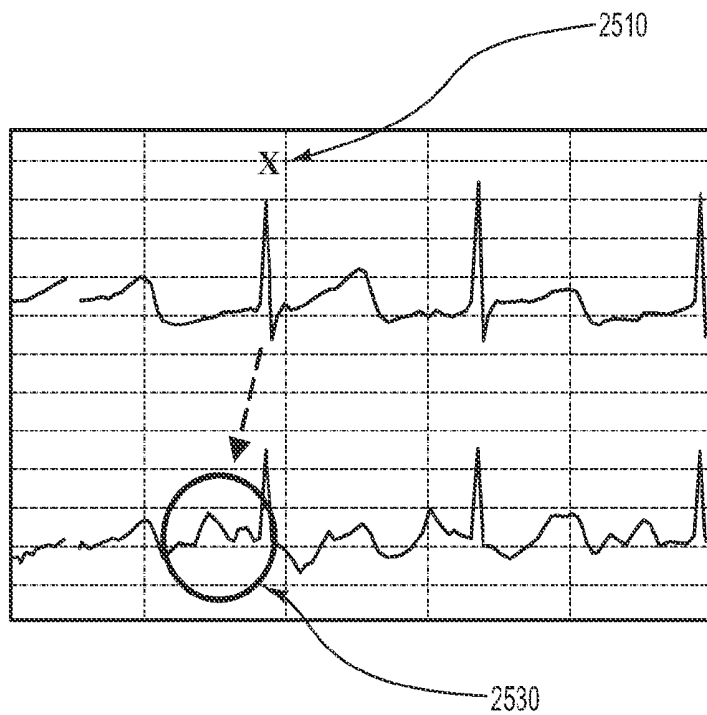

FIG. 21B

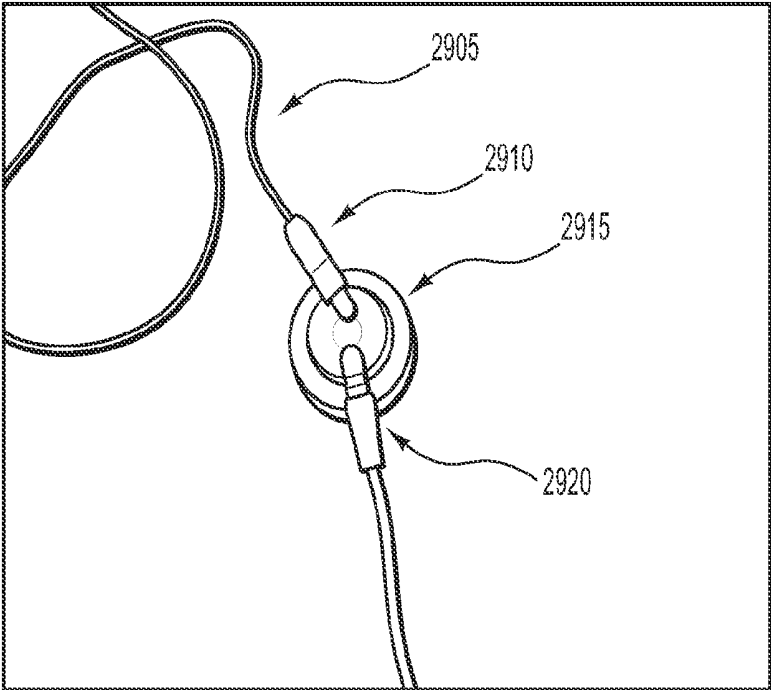

FIG. 22A

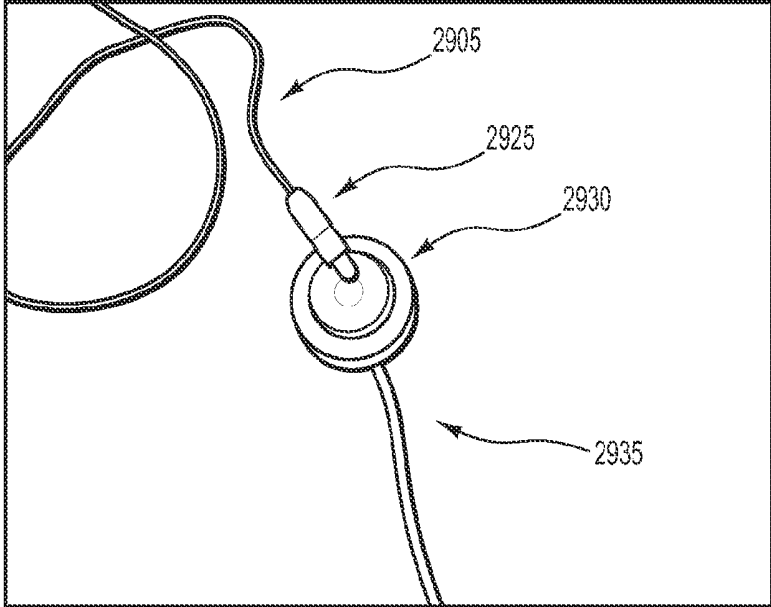

FIG. 22B

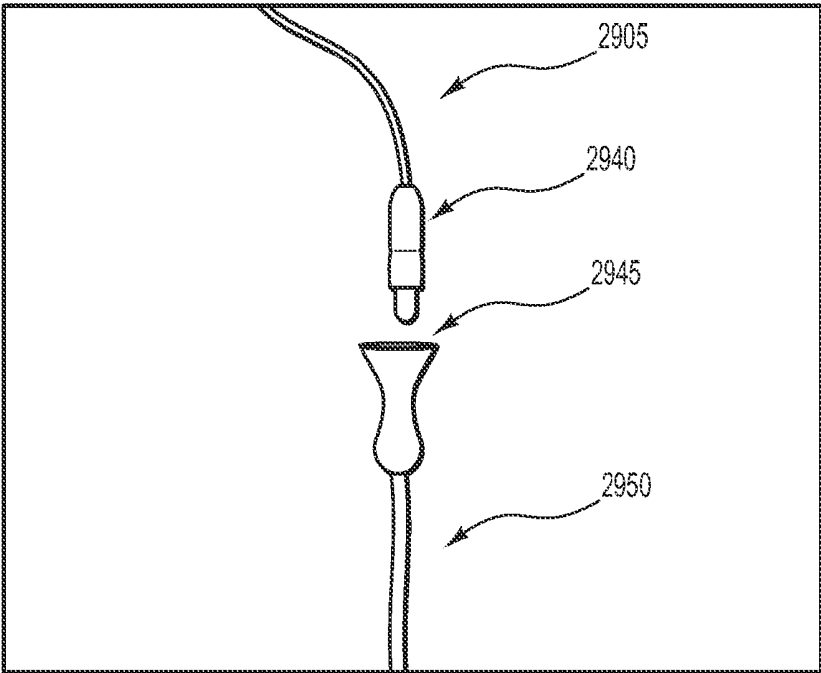

FIG. 22C

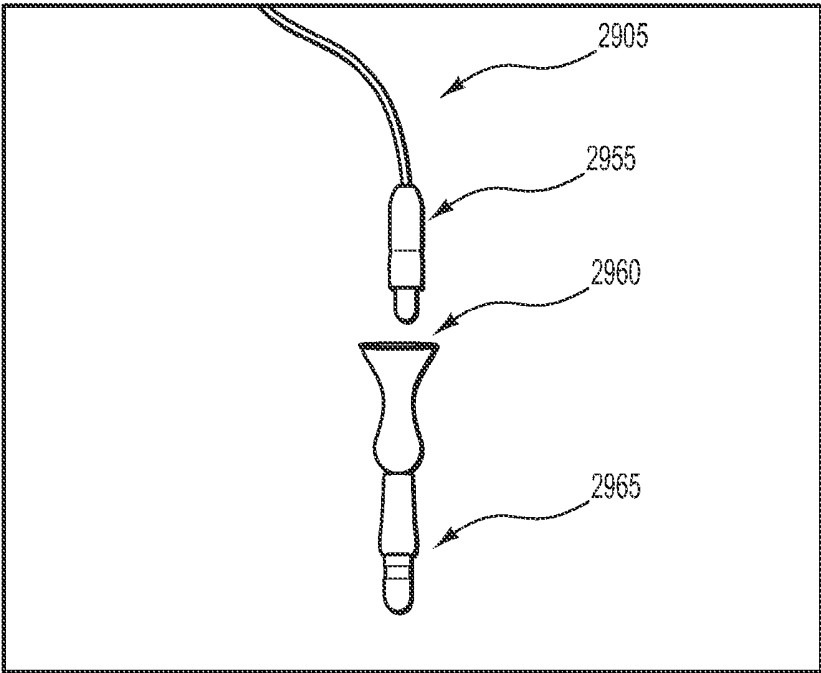

FIG. 22D

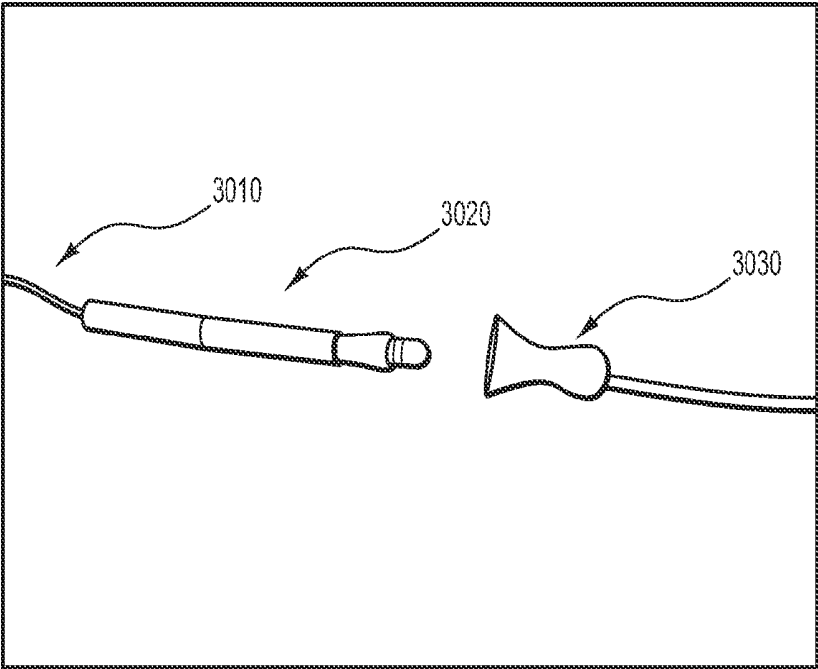

FIG. 23A

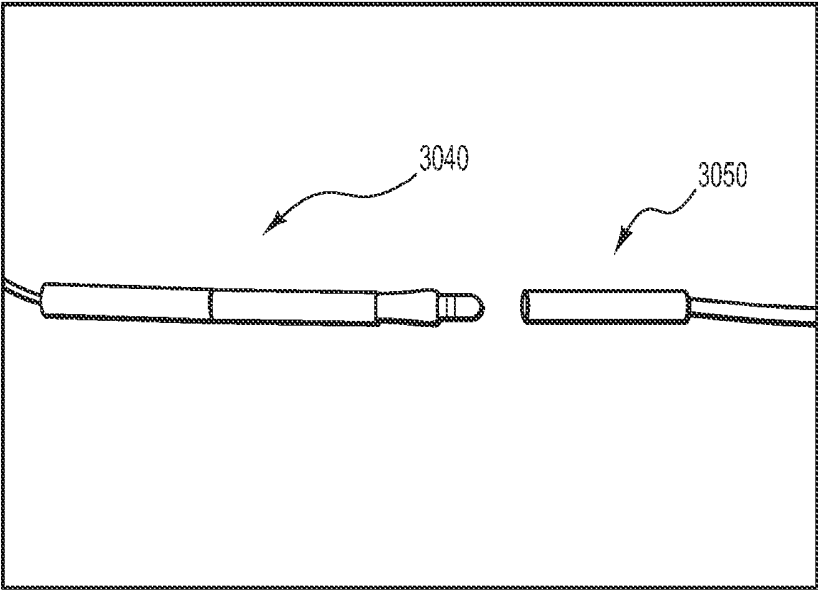

FIG. 23B

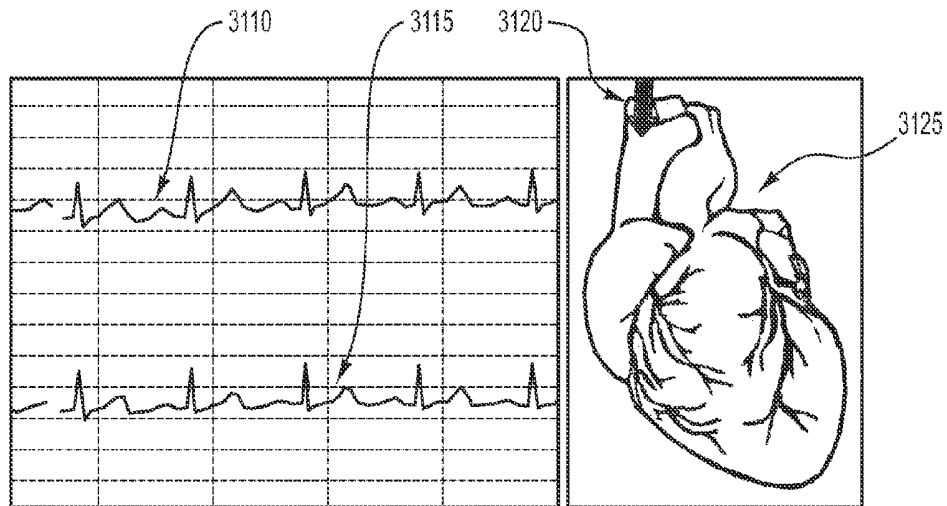

FIG. 24A

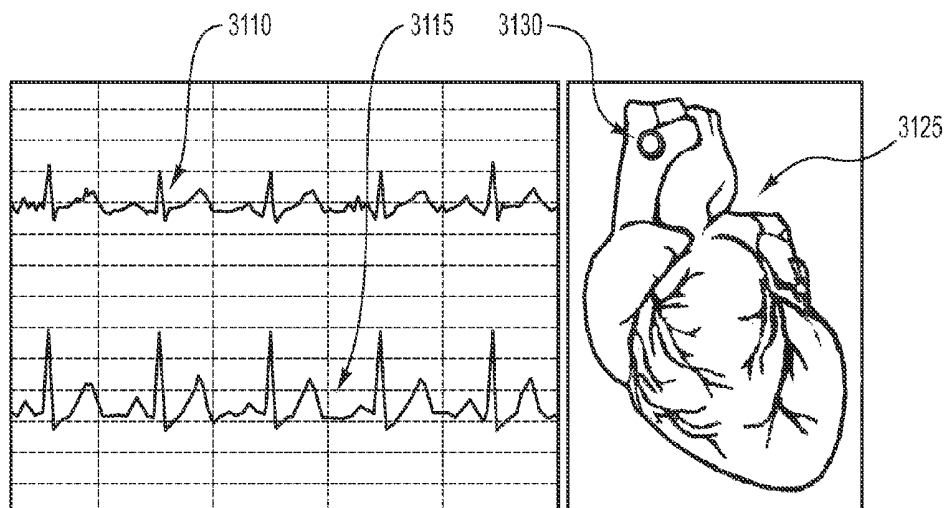

FIG. 24B

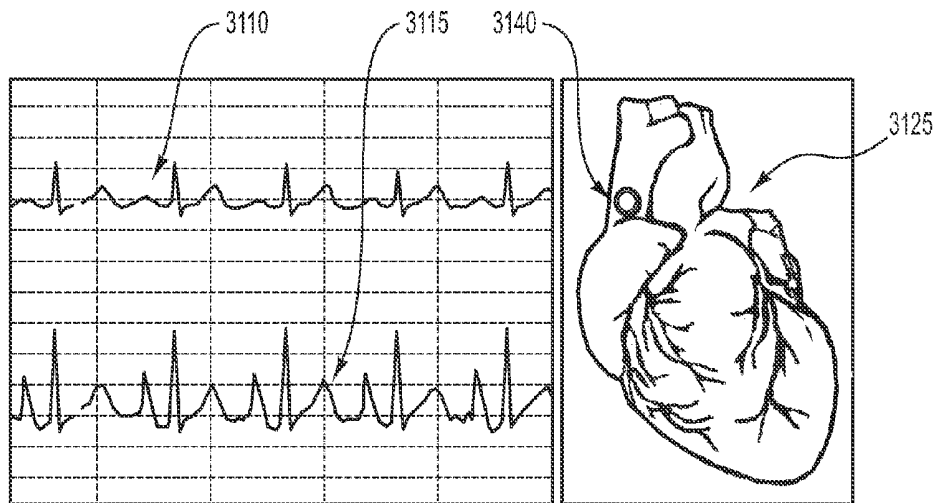

FIG. 24C

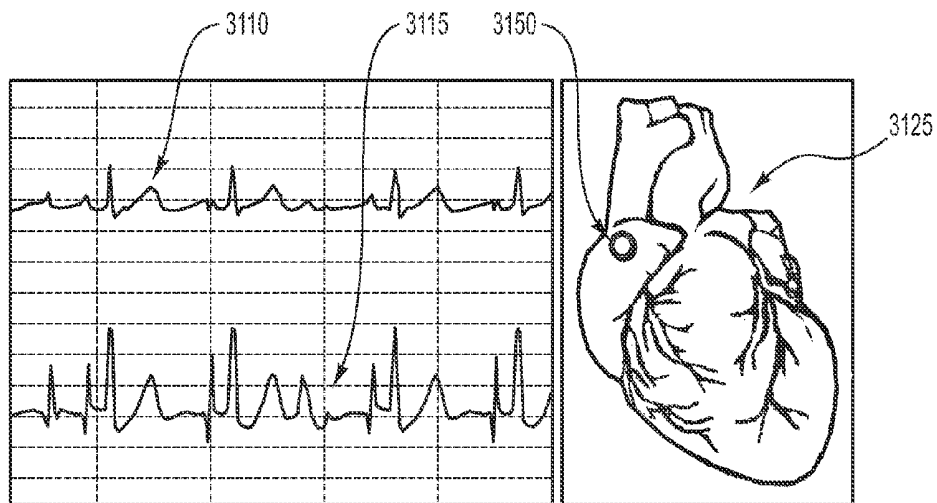

FIG. 24D

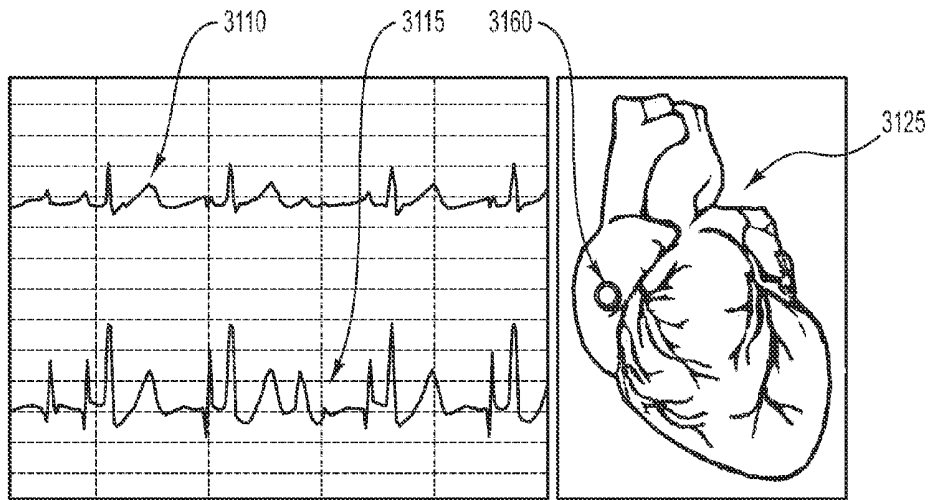

FIG. 24E

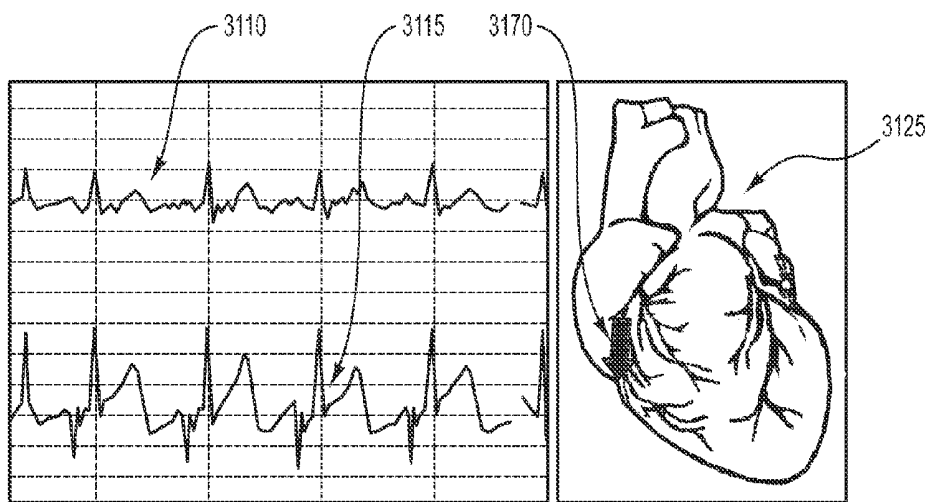

FIG. 24F

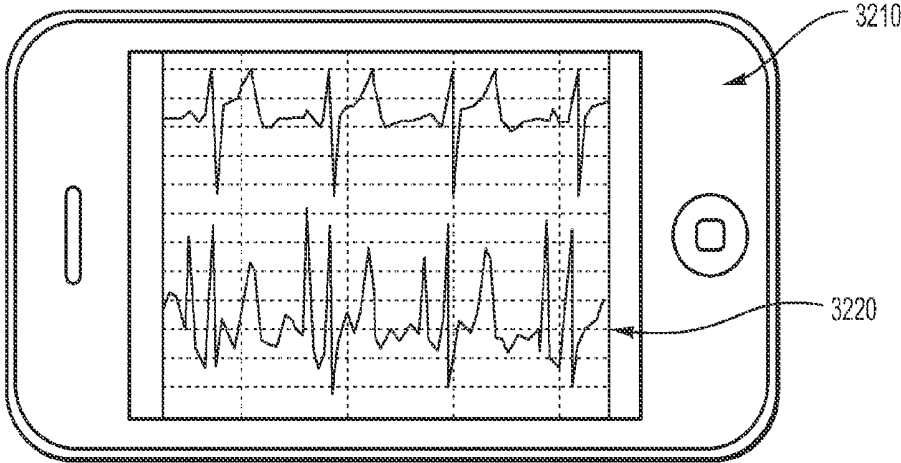

FIG. 25A

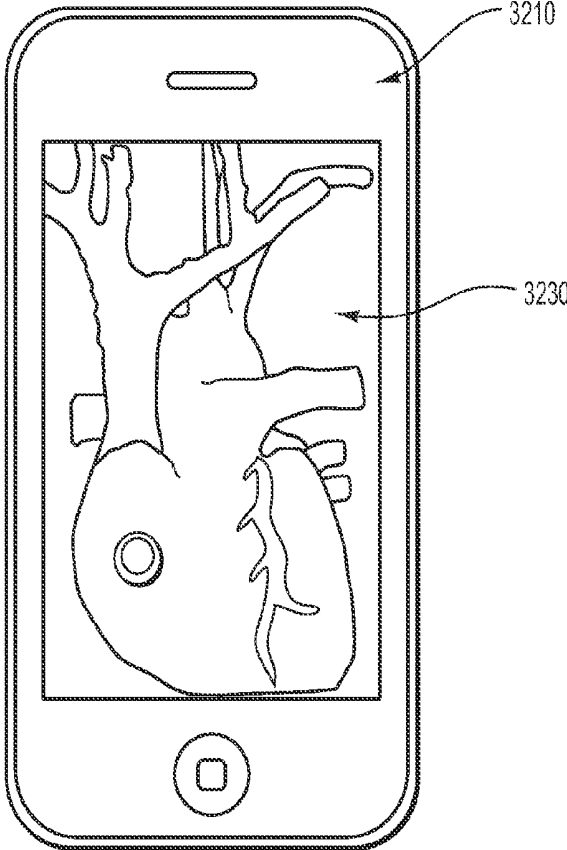

FIG. 25B

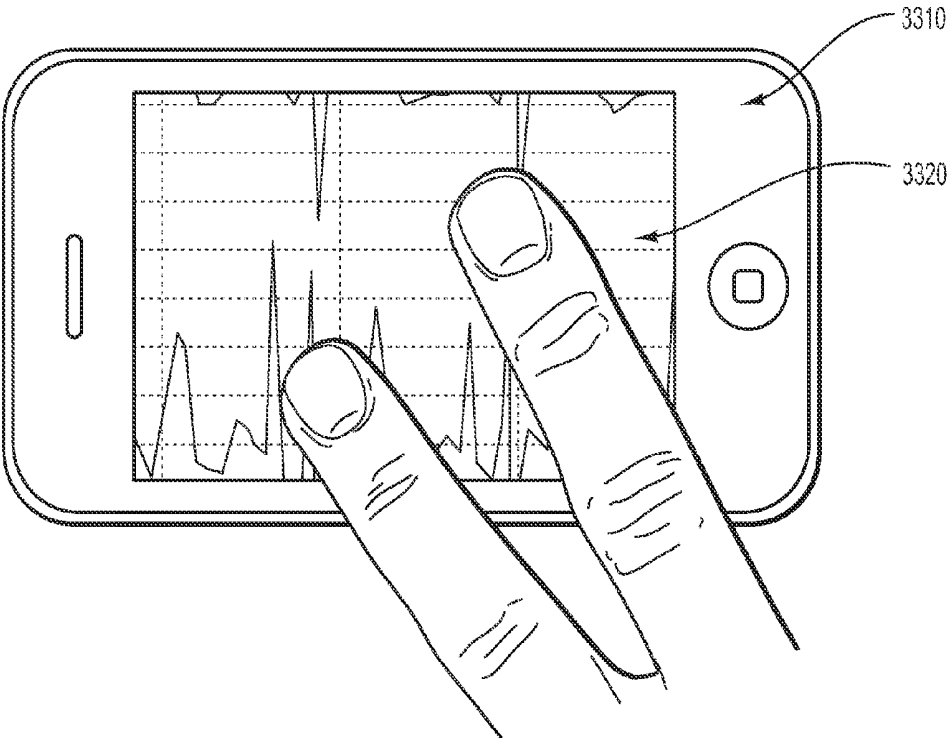

FIG. 26

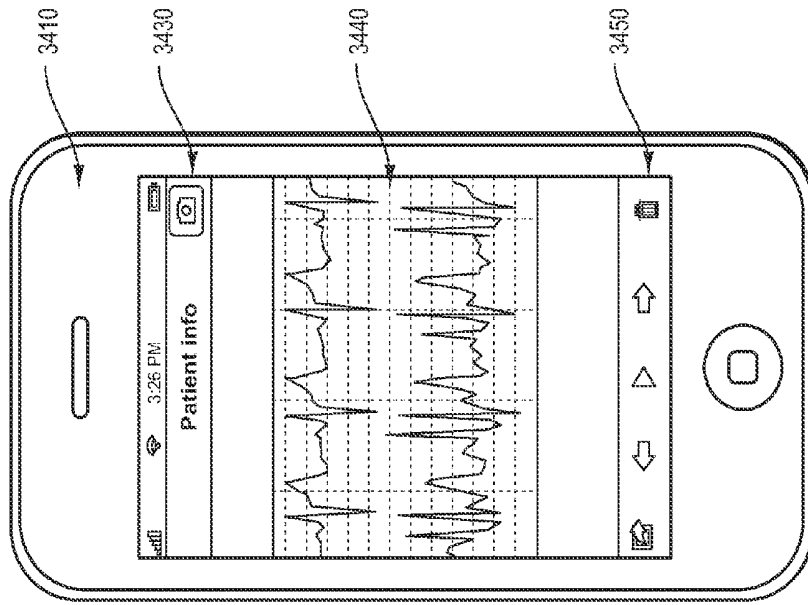

FIG. 27B

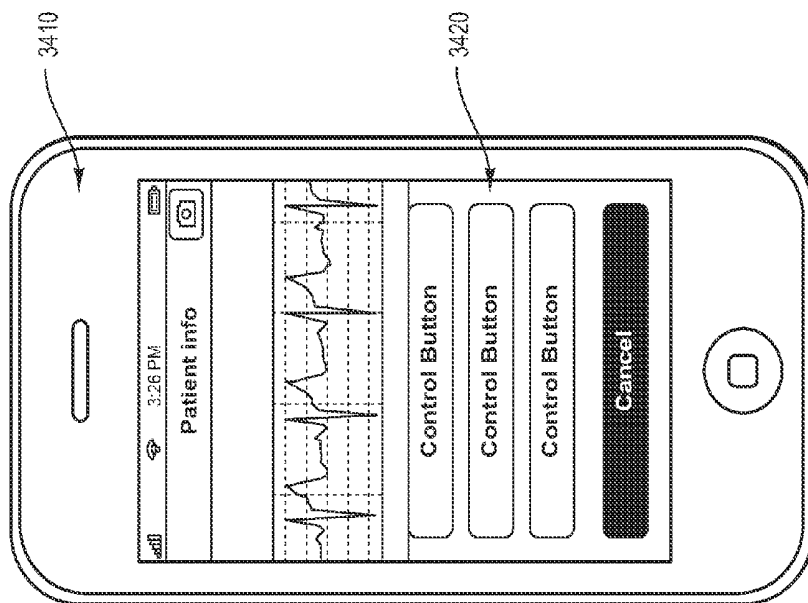

FIG. 27A

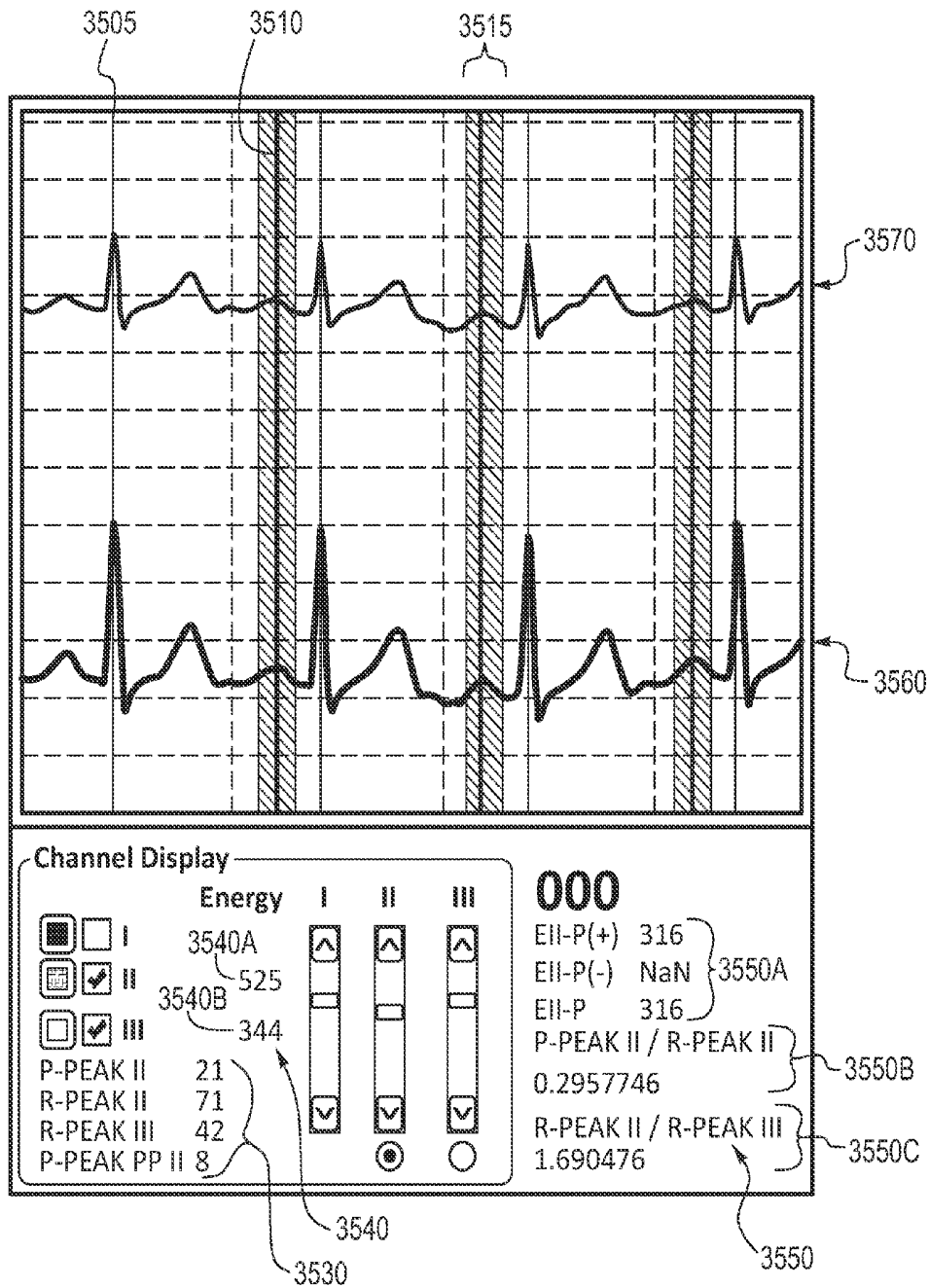

FIG. 28

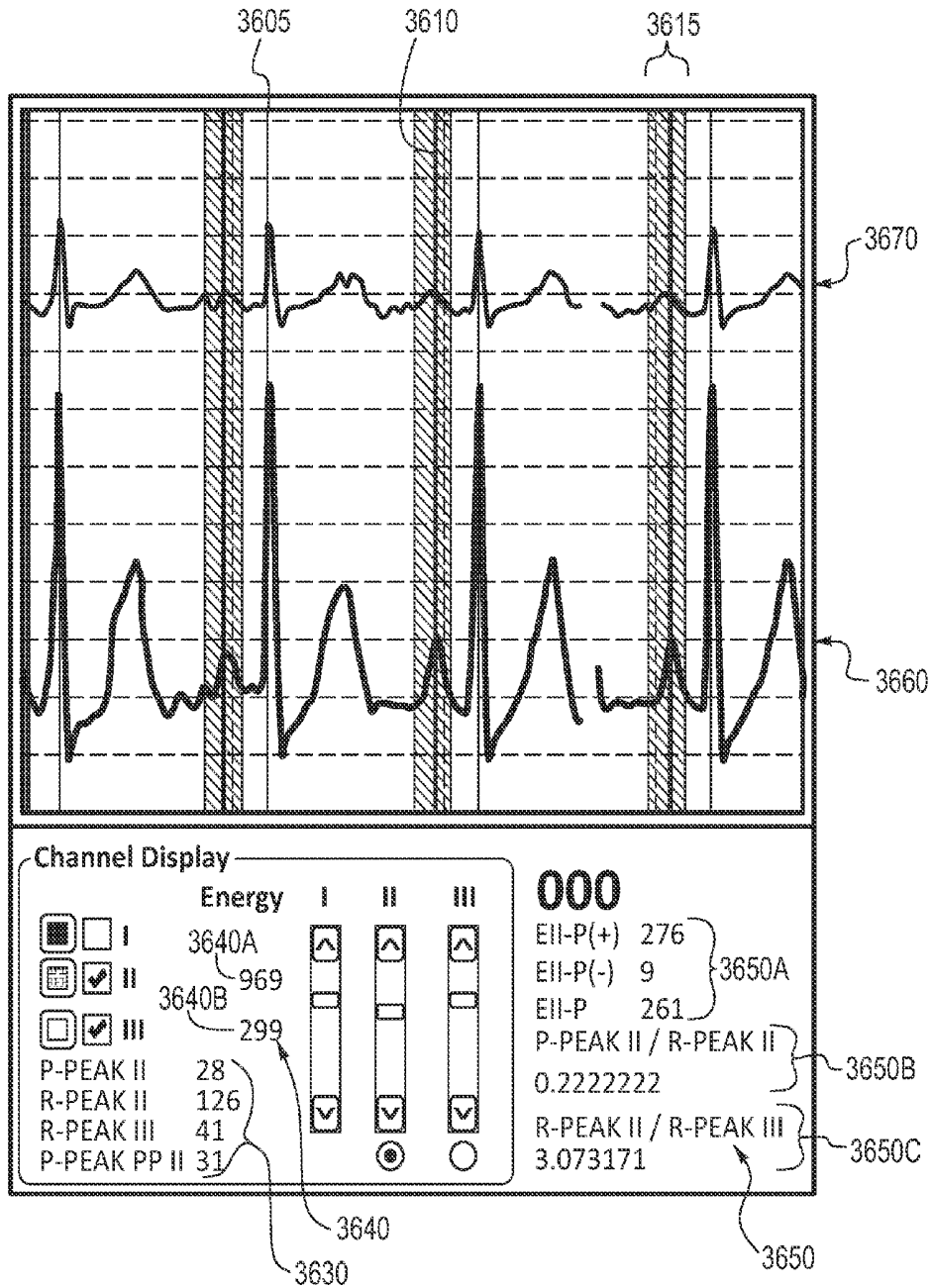

FIG. 29

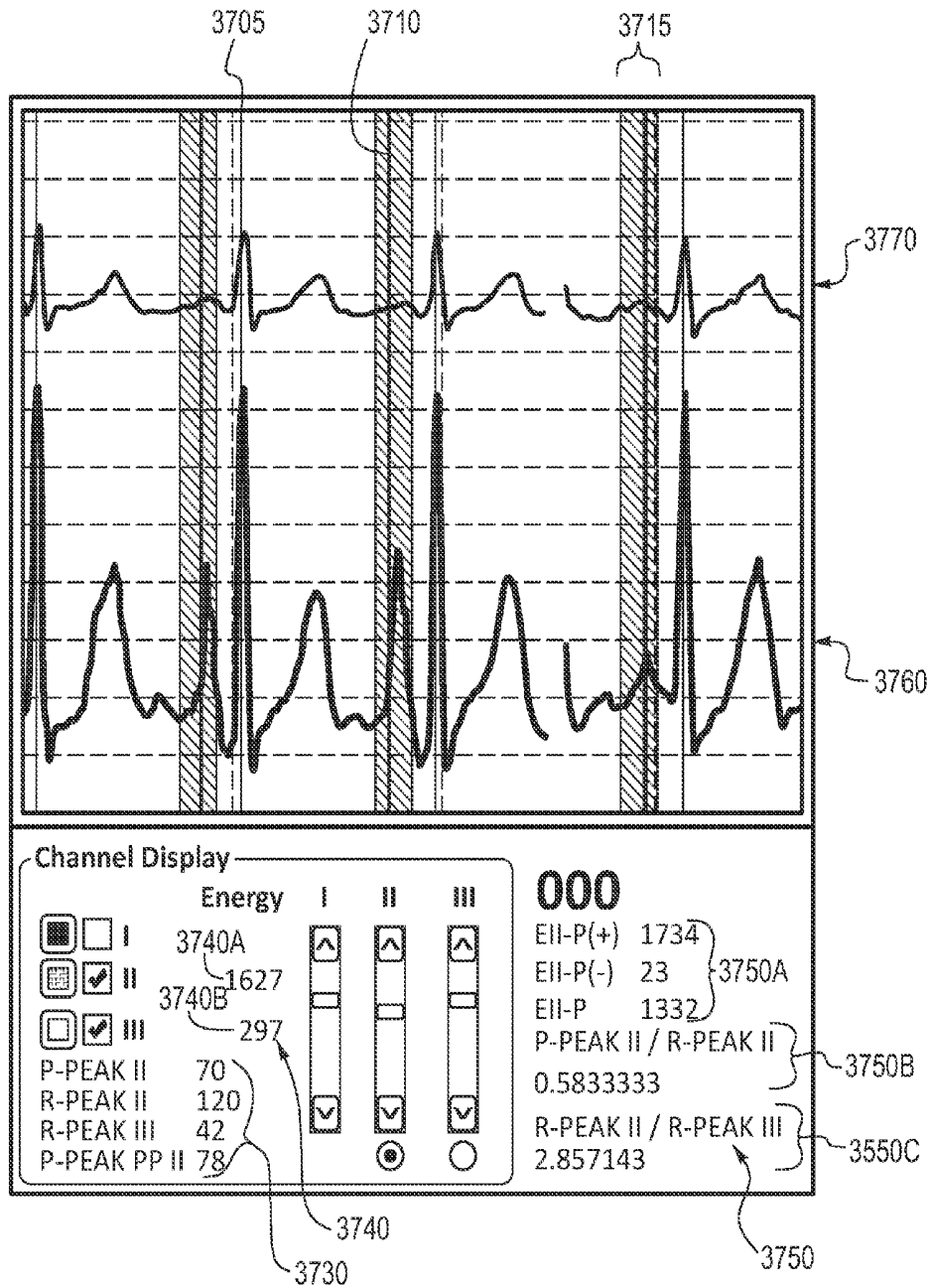

FIG. 30

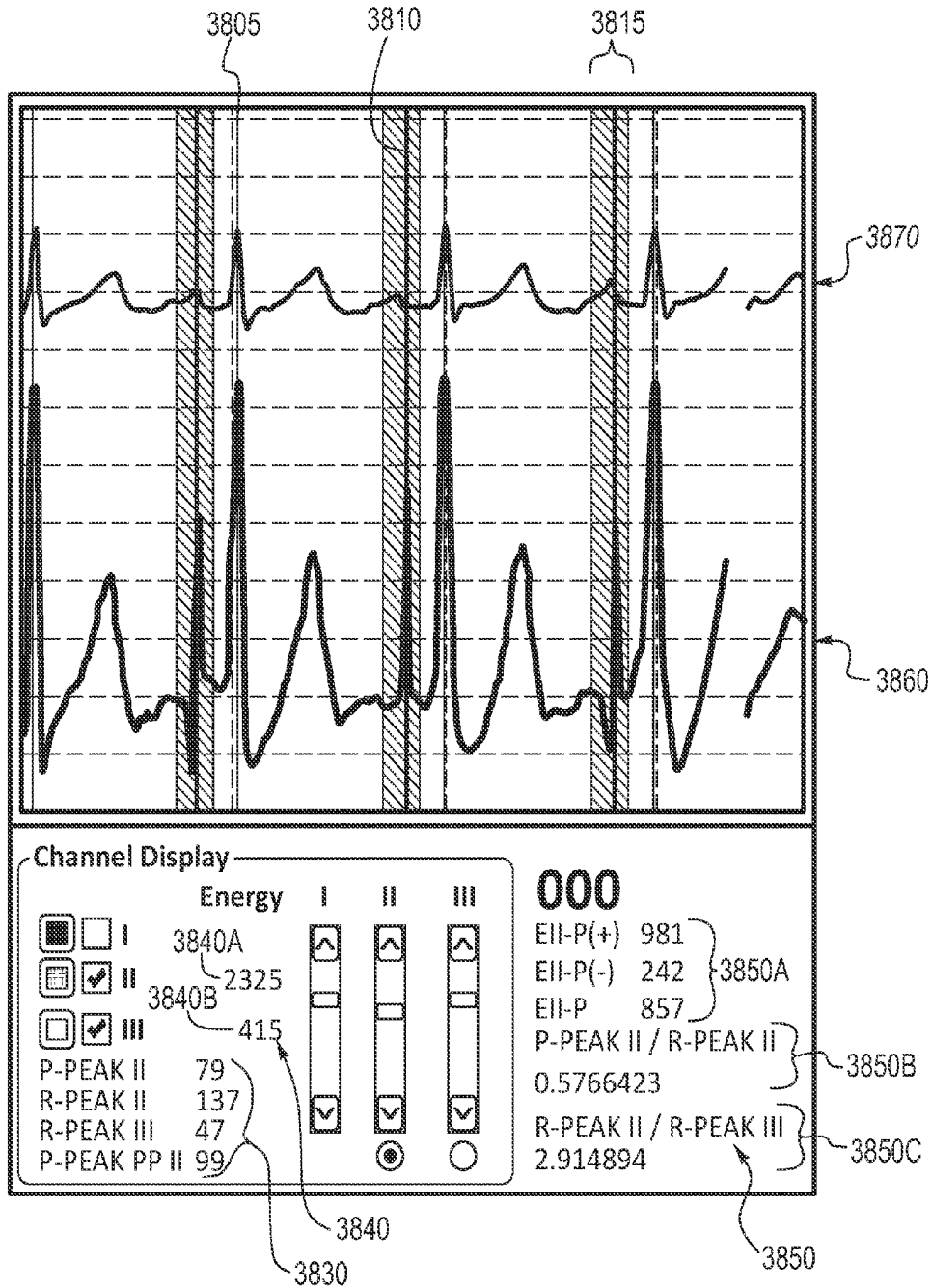

FIG. 31

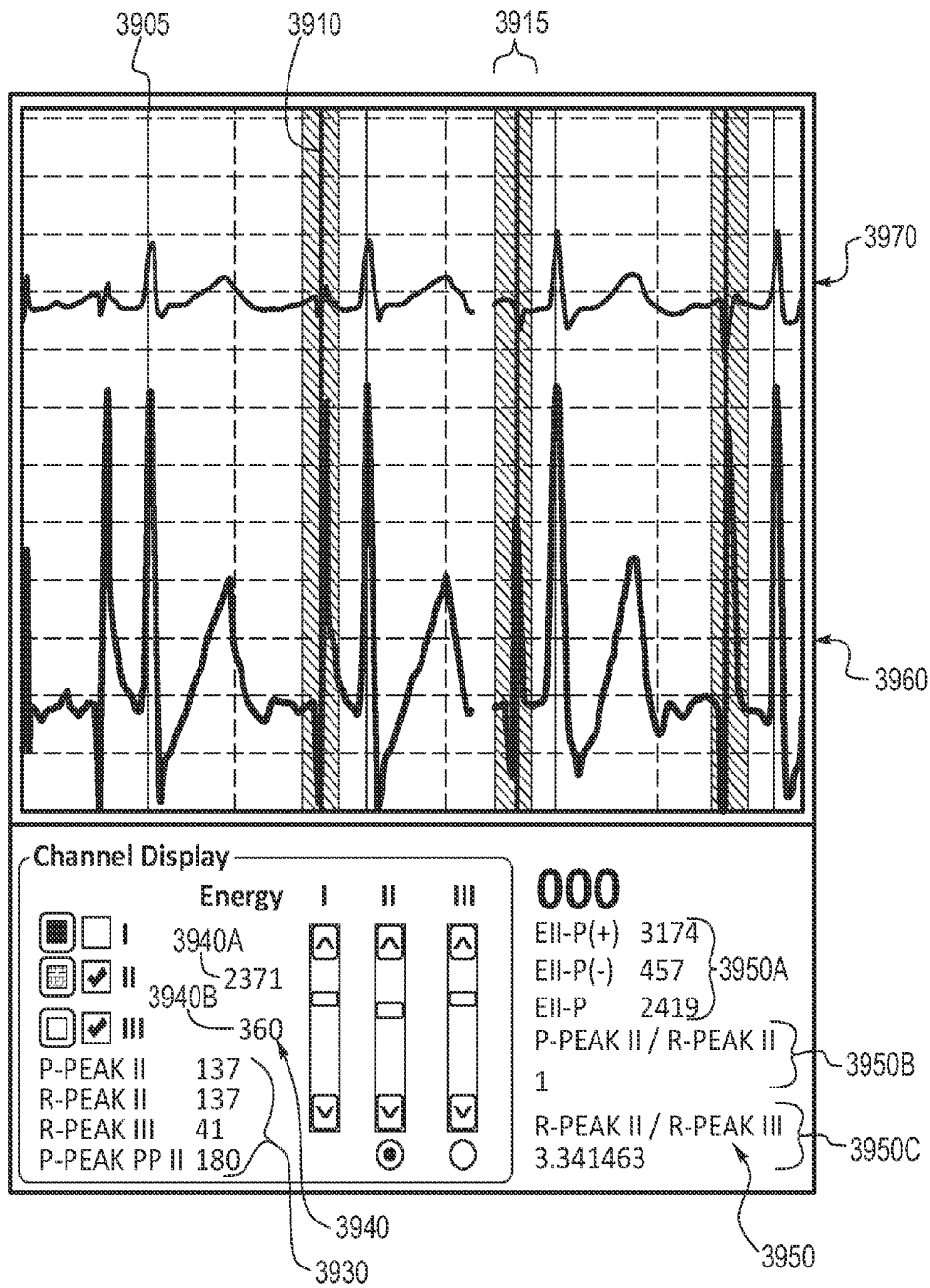

FIG. 32

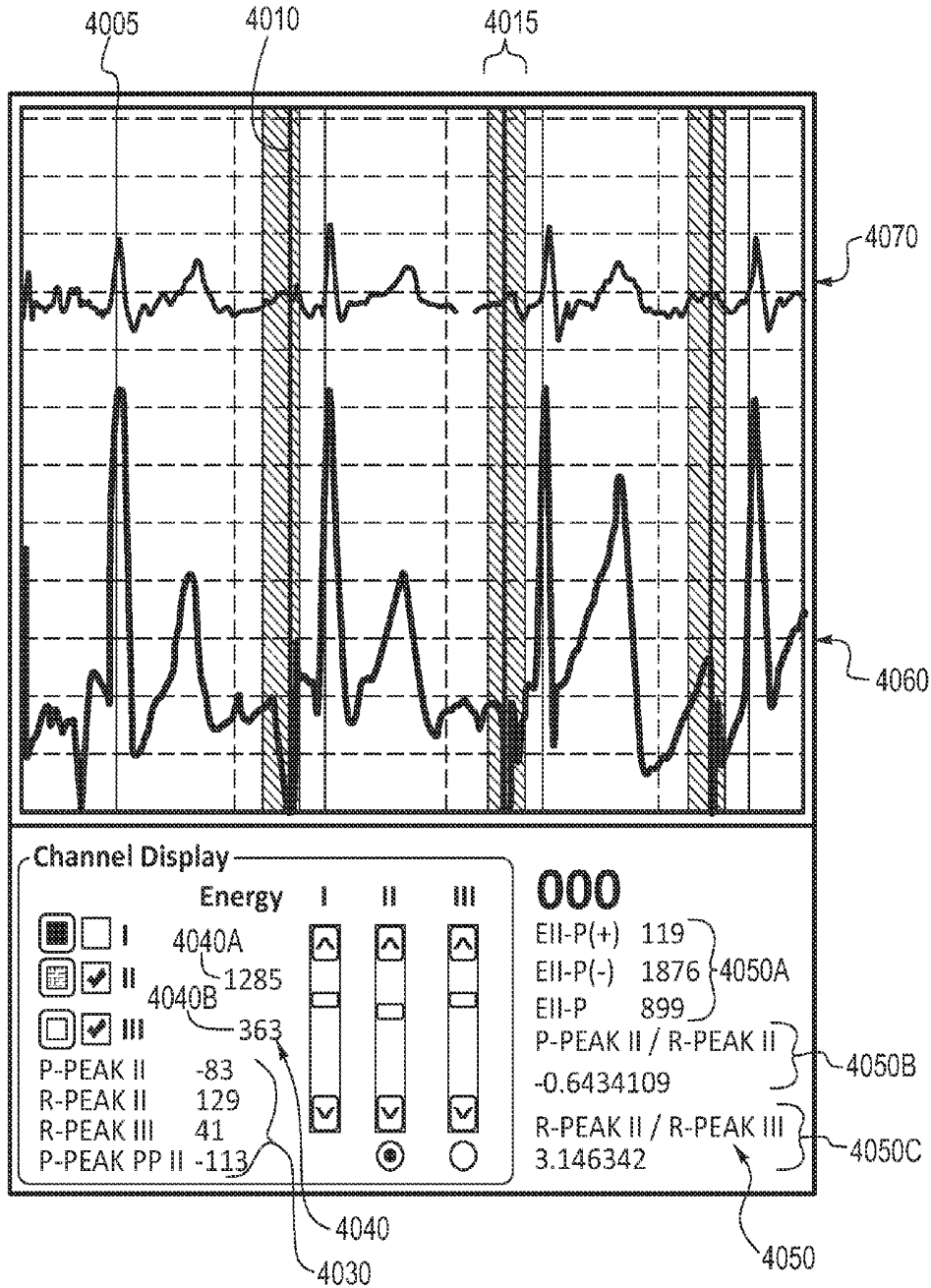

FIG. 33

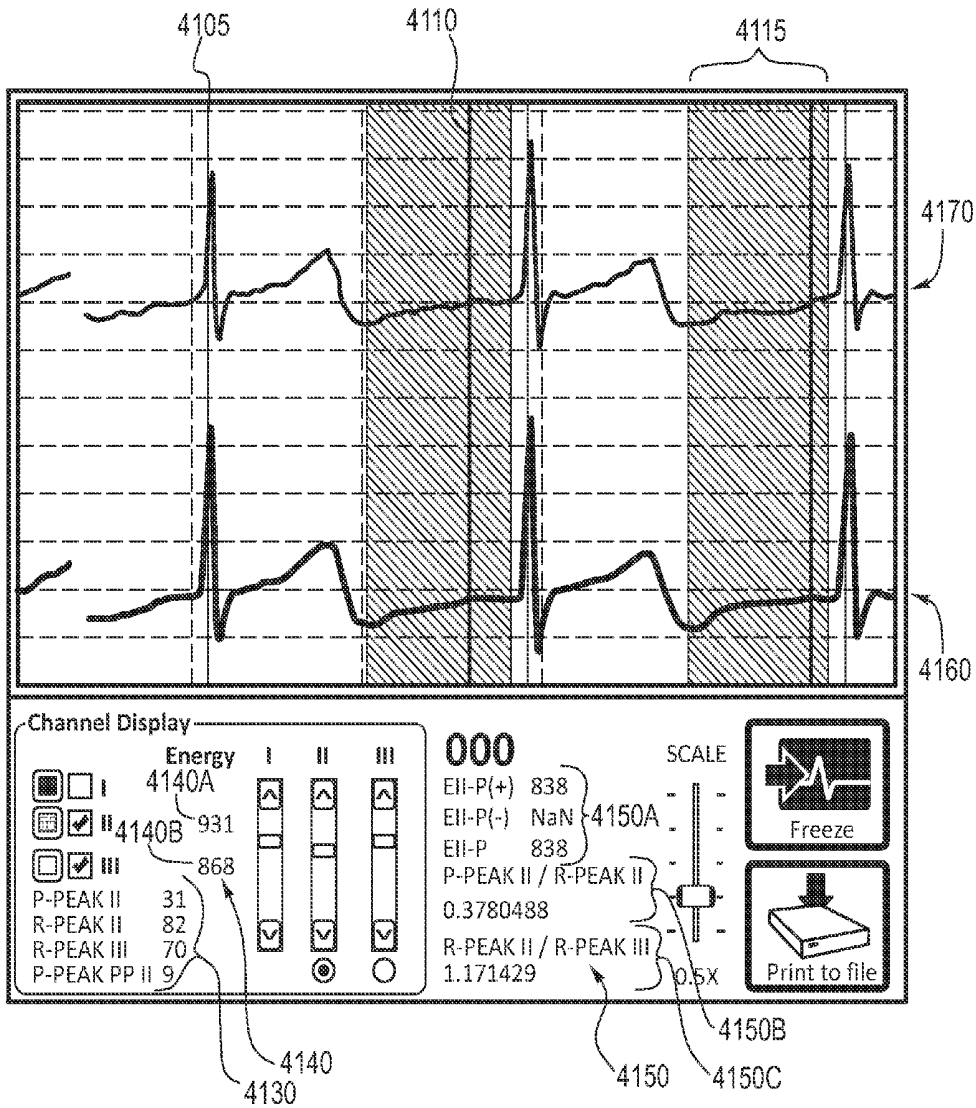

FIG. 34

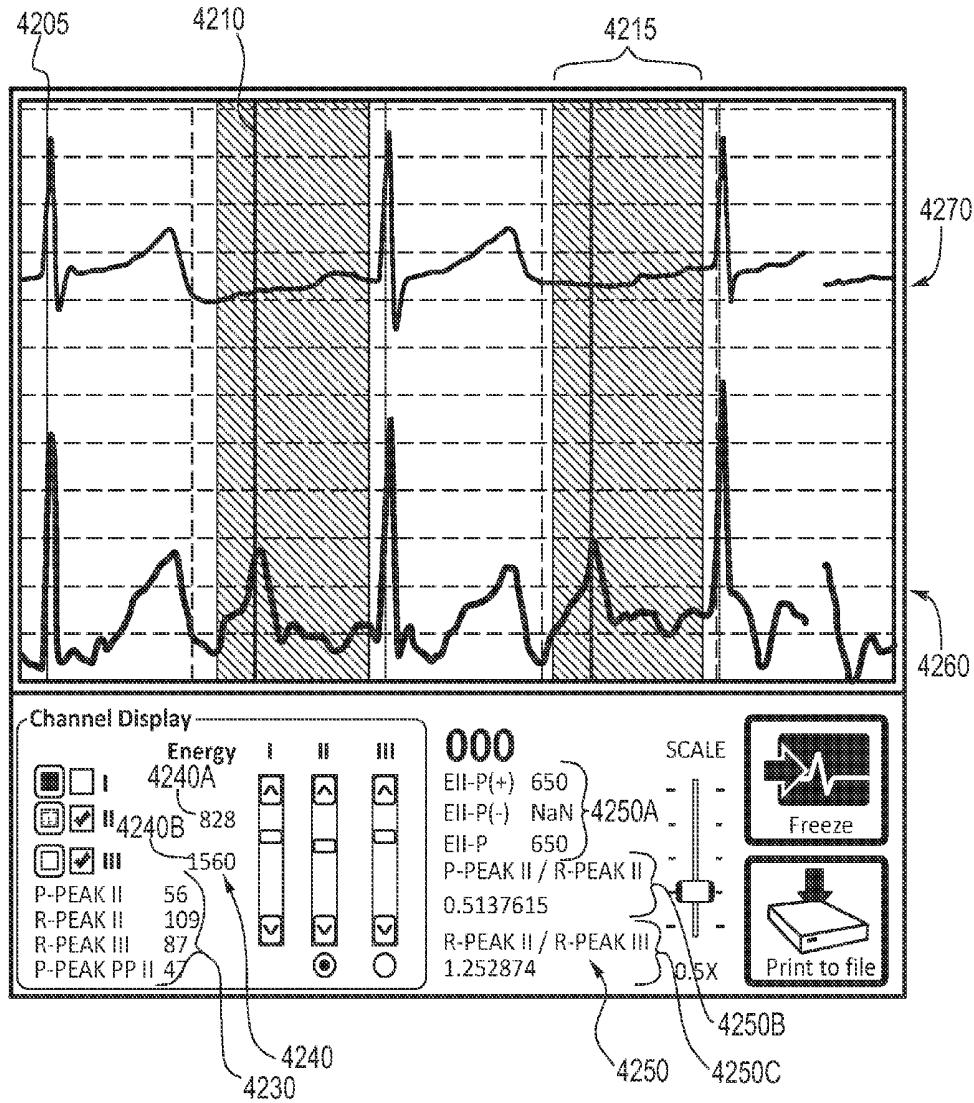

FIG. 35

Energy type	Location	Skin	Upper SVC	Lower 1/3 SVC	CAJ	RA	IVC
Lead II R-R Energy E _{RR-II}		525	969	1627	2325	2371	1285
Lead III R-R Energy E _{RR-III}		344	299	297	415	360	363
R = E _{RR-II} / E _{RR-III}		1.53	3.24	5.48	5.60	6.59	3.54

FIG. 36

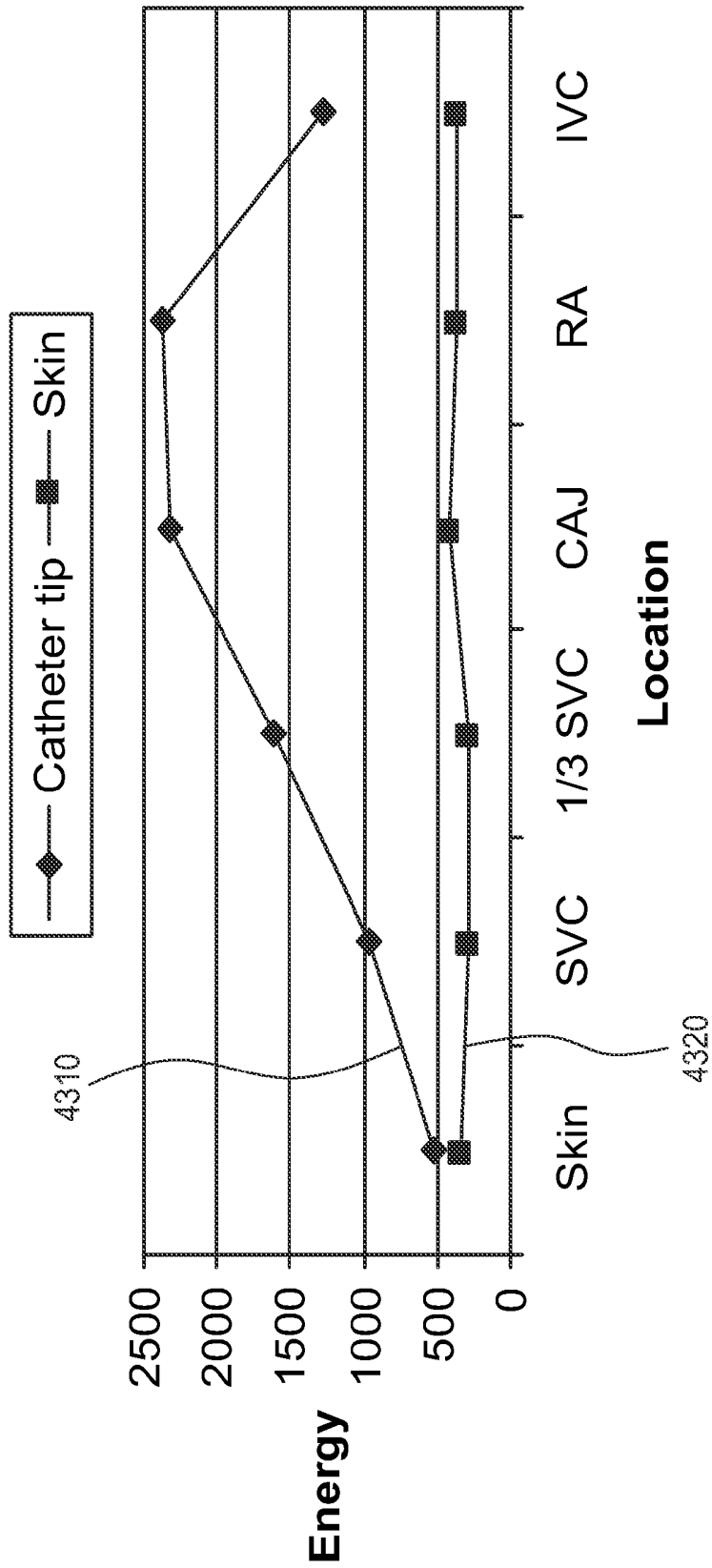

FIG. 37

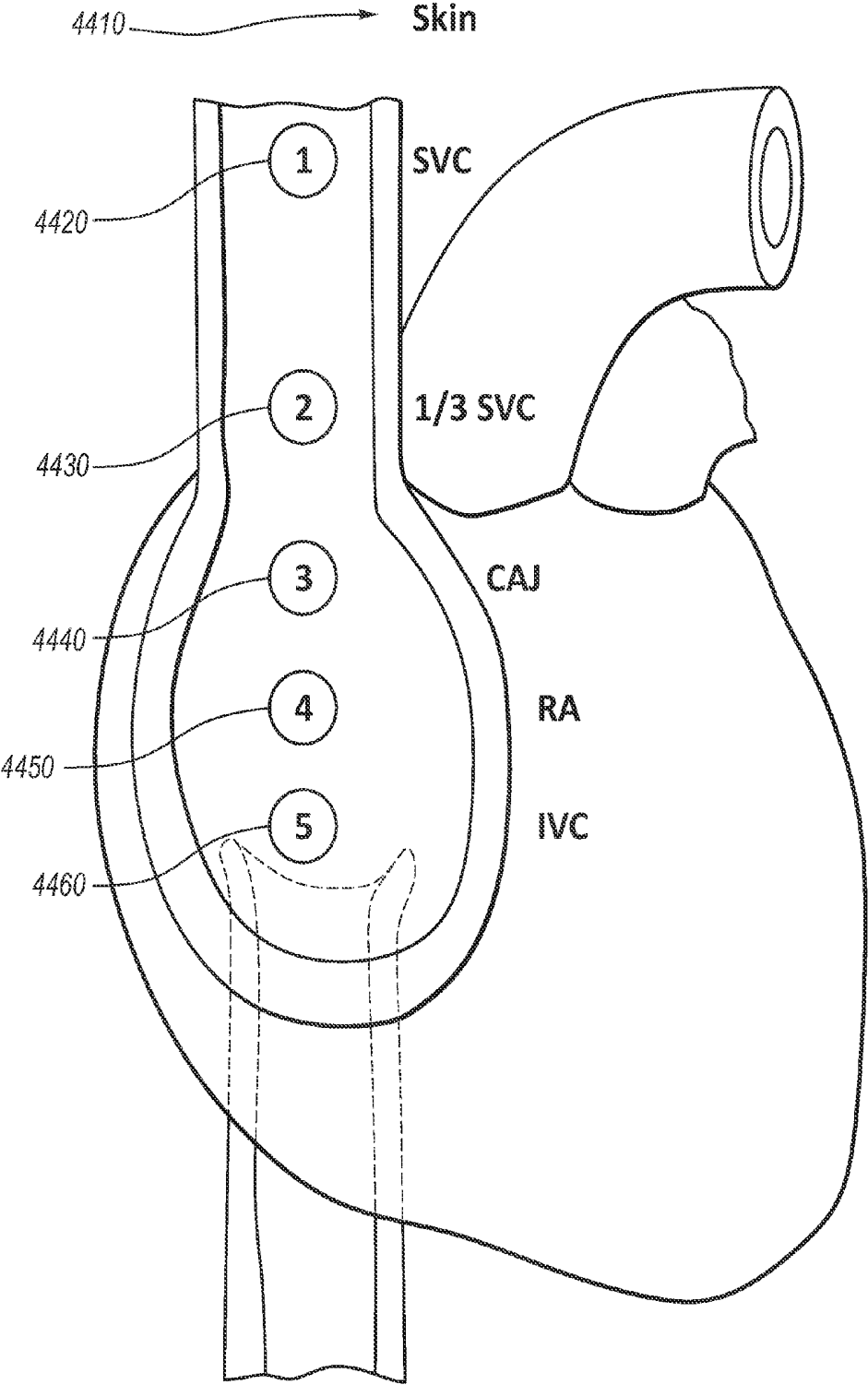

FIG. 38

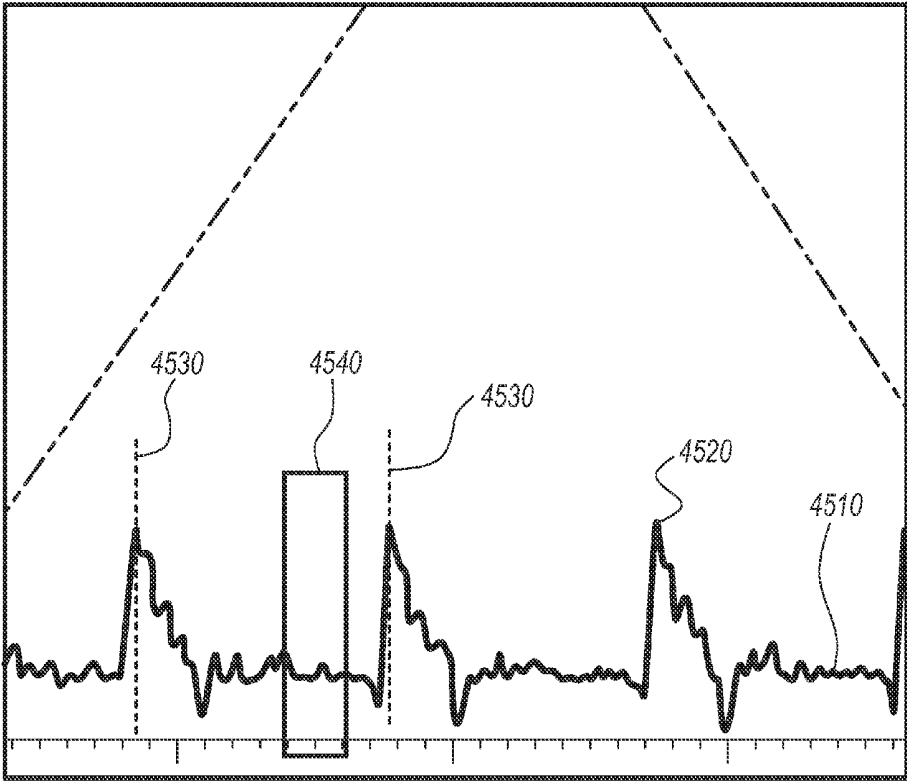

FIG. 39

APPARATUS AND METHOD FOR CATHETER NAVIGATION USING ENDOVASCULAR ENERGY MAPPING

CROSS-REFERENCE TO RELATED APPLICATIONS

This application is a continuation-in-part of U.S. patent application Ser. No. 13/019,939, filed on Feb. 2, 2011, now U.S. Pat. No. 9,125,578, which is a continuation-in-part of U.S. patent application Ser. No. 12/854,083, filed Aug. 10, 2010, now U.S. Pat. No. 9,445,734, which is a continuation-in-part of U.S. patent application Ser. No. 12/815,331, filed on Jun. 14, 2010, now U.S. Pat. No. 9,339,206, which claims the benefit of U.S. Provisional Patent Application No. 61/213,474, filed on Jun. 12, 2009, the disclosures of which are incorporated herein by reference in their entireties. This application also claims the benefit of U.S. Provisional Patent Application No. 61/344,732, filed on Sep. 23, 2010, the disclosure of which is incorporated herein by reference in its entirety.

BACKGROUND

The electrical conduction system of the heart creates specific electrical signals, electrical energy distributions and behaviors thereof which are indicative of specific locations in the thoracic cavity and/or of specific heart functions or conditions. When measured endovascularly, i.e., from within blood vessels or from within the heart, certain parameters of the electrical activity of the heart can be used to identify specific locations in the cardiovascular system and/or functional conditions, normal or abnormal. Moreover, by locally and accurately identifying the location and the type of condition, therapy of such conditions can be optimized and the effect of the therapy monitored in real-time.

Two types of clinical applications are typically addressed. The first is related to guiding endovascular devices through the cardiovascular system, while the second is related to the non-invasive or the minimally invasive remote monitoring of the electrical activity of the heart.

The guidance, positioning, and placement confirmation of endovascular catheters are necessary in a number of clinical applications, such as, for example:

1. Central venous access, e.g., CVC, PICC, implantable ports;
2. Hemodialysis catheters;
3. Placement of pacemaker leads;
4. Hemodynamics monitoring catheters, e.g., Swan-Ganz and central pressure monitoring catheters; and
5. Guiding guidewires and catheters into the left heart.

The location of the catheter tip is very important to the patient safety, the duration and the success of the procedure. Today's golden standard for confirming the target location of the catheter tip is the chest X-ray. In addition, there are currently two types of real-time guiding products available on the market, which try to overcome the limitations of chest X-ray confirmation: electromagnetic and ECG-based. In hospitals where real-time guidance is used results have improved in terms of reducing the number of X-rays, the procedure time, and the cost of the procedure. Under real-time guidance first-time success rate has typically increased from 75%-80% to 90%-95%. In addition, in hospitals where ECG guidance is used, e.g., in Italy, Belgium, Germany, chest X-ray confirmation has been eliminated for more than 90% of the patients. Electromagnetic systems are used mostly in the United States while ECG-based systems are

used mostly in Europe. Amongst other factors which determine the difference between the markets in the United States and Europe in terms of technology adoption: a) type of health care personnel allowed to perform procedures: nurses have more flexibility in the United States, b) type of devices placed: PICCs are placed more and more often in the United States, c) price sensitivity: the European market seems to be more price sensitive, and d) the current guiding devices are commercialized by specific manufacturers to work exclusively with their catheters: market penetration of the guiding systems reflects the market penetration of the catheter manufacturer.

It was also found that different opinions exist regarding where the target tip location should be: for example, lower third of the SVC or RA. Therefore guiding technologies should allow for discrimination of these locations. The chest X-ray, which is the current golden standard does not always allow for such discrimination requiring an accuracy of typically better than 2 cm. Also, because ECG-based systems make use of physiological information related to the heart activity, their ability to guide placement is accurate with respect to the anatomy. This is not the case with electromagnetic guiding systems which measure the distance between the catheter tip in the vasculature and an external reference placed typically on the patient's chest. Because of this aspect, ECG-based systems can be used to document the final result of the catheter placement potentially replacing the chest X-ray as the golden standard.

One of the most valuable diagnostic tools available, the ECG records the heart's electrical activity as waveforms. By interpreting these waveforms, one can identify rhythm disturbances, conduction abnormalities, and electrolyte imbalance. An ECG aids in diagnosing and monitoring such conditions as acute coronary syndromes and pericarditis. The heart's electrical activity produces currents that radiate through the surrounding tissue to the skin. When electrodes are attached to the skin, they sense these electrical currents and transmit them to the electrocardiograph. Because the electrical currents from the heart radiate to the skin in many directions, electrodes are placed at different locations on the skin to obtain a total picture of the heart's electrical activity. The electrodes are then connected to an electrocardiograph device, or computer, and record information from different perspectives, which are called leads and planes. A lead provides a view of the heart's electrical activity between two points or poles. A plane is a cross section of the heart which provides a different view of the heart's electrical activity. Currently, the interpretation of an ECG waveform is based on identifying waveform component amplitudes, analyzing and then comparing the amplitudes with certain standards. Modifications of these amplitude components are indicative of certain conditions, e.g., the elevation of the ST segment or of certain locations in the heart, e.g., the amplitude of the P-wave. In today's practice ECG monitors are widely used to record ECG waveforms. More and more often applications are made available for automatic identification of the ECG amplitude components. In certain cases tools are available for decision making support and for automatic interpretation of ECG amplitude components with respect to underlying heart conditions.

Remote patient monitoring is a well established medical field. Still remote monitoring of heart conditions is not as widely accepted as it would be need and possible. One of the reasons is related to the relatively complicated way of acquiring signals related to the heart activity, in particular ECG signals. Another important limiting factor of the current remote monitoring technologies is the use of commu-

nications channels, like the telephone line, which are difficult to interface with at both the patient and the physician ends.

BRIEF SUMMARY

Briefly summarized, embodiments of the present invention are directed to systems, devices, and methods for obtaining and using endovascular electrograms (or electrocardiograms/ECGs) in a number of clinical applications and settings. For example, the devices can be used to guide endovascular devices in and around the heart, e.g., guiding central venous access devices in the superior vena cava, right atrium, and right ventricle. Such central venous access devices may include central venous catheters (CVC), peripherally inserted central catheters (PICC), implantable ports, hemodialysis catheters, tunneled catheters and others.

In one aspect, one or several skin electrodes are used to obtain skin surface ECG signals simultaneous with the acquisition of endovascular (intracavitary) electrogram (ECG) signals via the use of endovascular (intracavitary) electrodes. The simultaneous and synchronized skin surface and endovascular ECG signals are used in one of several ways to analyze and quantify the ECG signals as a function of the location of the endovascular electrode, e.g. as a function of the tip of a catheter.

In light of the above, in one embodiment the ease-of-use of the ECG-based catheter navigation and tip location is enhanced. In one aspect, for instance, skin ECG reference waveforms are simultaneously presented on a display with endovascular ECG waveforms measured at the tip of a catheter or other indwelling medical device. Such simultaneous acquisition and display of concurrent ECG signals allows for ready interpretation of the endovascular ECG waveform at the tip of the catheter. In another aspect, a skin ECG reference signal is used to synchronize information processing algorithms applied to the endovascular ECG signal, yielding results of enhanced reliability concerning changes of P-wave of the endovascular ECG signal in terms of shape and energy.

In greater detail, in one embodiment a skin ECG signal can be used as a reference and compared to an endovascular ECG signal in order to detect changes in the endovascular ECG relative to the skin ECG.

In another embodiment, analysis of the synchronized skin and/or endovascular ECG signals can be linked to one another and/or to the periodic electrical activity of the heart. For example, a skin ECG lead can be used to detect the R-peak of the QRS complex of a detected skin ECG waveform. Detection of the R-peak in the skin ECG waveform can be used to trigger analysis of the endovascular ECG signal in a simultaneously corresponding segments of the endovascular ECG waveform, e.g., in the segment corresponding to the P-wave. Such triggering is particularly useful in case of arrhythmia, wherein the skin ECG waveform does not typically demonstrate a consistent P-wave, while the endovascular ECG waveform indeed includes a detectable P-wave segment that changes as a function of the location in the vasculature.

In another embodiment, a skin ECG lead can be used to monitor the patient's heart activity at the same time an endovascular ECG lead is employed to guide a catheter or other suitable indwelling or endovascular devices through the vasculature. In another embodiment, R-peaks detected in the skin ECG waveform are used to trigger correlation computation and other types of signal processing on the

endovascular ECG signal in order to allow for efficient noise reduction in the resultant endovascular ECG waveform.

In another aspect, a connector for establishing an operable connection between a catheter in the sterile field of the patient and an ECG cable outside of the sterile field is described, allowing for single operator utilization of the apparatus for catheter navigation and tip location introduced herein.

In another aspect, algorithms are introduced that allow for mapping certain ECG waveforms to corresponding locations in the vasculature. In one embodiment, the algorithm analyzes directional electrical energy present at the tip of a catheter or other endovascular device capable of detecting endovascular ECG signals. In another embodiment the algorithm can map the catheter tip to a certain location in the vasculature based on endovascular ECG signals so as to allow for catheter navigation.

In another aspect, a simplified graphical user interface is disclosed, depicting a moving graphical indicator over a heart icon so as to indicate a location of a catheter tip in the vasculature as determined by the endovascular ECG signal. The graphical indicator can include different colors and shapes, such as dots or arrows, for instance. The colors and shapes of the graphic indicator may change as a function of the tip location in the vasculature.

In another aspect, an ECG signal acquisition module is disclosed that is operably connectable, via a suitable interface, to a mobile phone or other portable electronic device. This enables control of the ECG signal acquisition module, including ECG signal analysis, by a user of the mobile phone. In another embodiment, the ECG signal acquisition module can be operably connected interfaced to other handheld or remote devices.

In another aspect, a user interface is included for use in connection with the mobile phone or other portable device to enable ECG signal-based guiding of endovascular devices by the mobile phone. In another embodiment, the user interface enables use of the mobile phone to support analysis and archival of ECG signals, catheter information, and results of a catheter placement procedure. In another embodiment, the user interface optimizes ECG signal acquisition for remote patient monitoring via the mobile phone or other handheld device.

In another aspect, a method is disclosed for locating an indwelling medical device within a vasculature of a patient. The method comprises identifying an endovascular ECG waveform complex from an endovascular ECG signal associated with the indwelling medical device, then calculating an absolute value of the energy of the endovascular ECG waveform complex over a predetermined segment thereof. A position of the medical device within the vasculature is then determined by observation of the absolute value of the energy of the predetermined segment of the endovascular ECG waveform complex.

There has thus been outlined, rather broadly, certain embodiments of the invention in order that the detailed description thereof herein may be better understood, and in order that the present contribution to the art may be better appreciated. There are, of course, additional embodiments of the invention that will be described below and which will form the subject matter of the claims appended hereto.

In this respect, before explaining at least one embodiment of the invention in detail, it is to be understood that the embodiments are not limited in their application to the details of construction and to the arrangements of the components set forth in the following description or illustrated in the drawings. Indeed, other embodiments in addi-

tion to those described herein can be conceived of, practiced, and carried out in various ways. Also, it is to be understood that the phraseology and terminology employed herein, as well as the abstract, are for the purpose of description and should not be regarded as limiting.

As such, those skilled in the art will appreciate that the conception upon which this disclosure is based may readily be utilized as a basis for the designing of other structures, methods and systems for carrying out the several purposes of embodiments of the present invention. It is important, therefore, that the claims be regarded as including such equivalent constructions insofar as they do not depart from the spirit and scope of this disclosure.

These and other features of embodiments of the present invention will become more fully apparent from the following description and appended claims, or may be learned by the practice of embodiments of the invention as set forth hereinafter.

BRIEF DESCRIPTION OF THE DRAWINGS

A more particular description of the present disclosure will be rendered by reference to specific embodiments thereof that are illustrated in the appended drawings. It is appreciated that these drawings depict only typical embodiments of the invention and are therefore not to be considered limiting of its scope. Example embodiments of the invention will be described and explained with additional specificity and detail through the use of the accompanying drawings in which:

FIG. 1A is a block diagram that depicts an apparatus according to an embodiment of the present invention.

FIG. 1B is a block diagram of an electronic module for acquisition and processing of endovascular electrocardiogram according to an embodiment of the present invention.

FIG. 2 depicts an adaptor for an endovascular device according to an embodiment of the present invention.

FIG. 3 depicts a catheter steering device according to an embodiment of the present invention.

FIGS. 4A, 4B, 4C, and 4D depict electrode configurations that provide optimal acquisition of endovascular electrocardiogram according to various embodiments of the present invention. FIG. 4A depicts a single lead configuration, FIG. 4B depicts a modified 3-lead configuration with monitoring and guiding capabilities, FIG. 4C depicts a telemetry configuration with a single grounded lead, and FIG. 4D depicts one use of ECG monitors for guiding endovascular devices.

FIG. 5 illustrates exemplary electrocardiogram signal amplitudes at different locations in the central venous system.

FIG. 6 illustrates exemplary electrocardiogram signal power spectra at different locations in the central venous system.

FIG. 7 illustrates exemplary electrocardiogram signal electrical energy distribution at different locations in the central venous system.

FIG. 8 depicts a graphical user interface according to an embodiment of the present invention.

FIG. 9 depicts a graphical user interface according to another embodiment of the present invention.

FIGS. 10A and 10B depict exemplary printouts for the information displayed by the graphical user interface, according to an embodiment of the present invention.

FIG. 11 is a block diagram for a computer-based method for positioning an endovascular device in or near the heart using electrocardiogram signals.

FIG. 12 illustrates another decision support algorithm for a computer-based method for positioning an endovascular device in or near the heart using electrocardiogram signals, according to one embodiment.

FIG. 13 illustrates the cardiac conduction system of the heart.

FIG. 14 illustrates electrical signal propagation in the conduction system of the heart.

FIG. 15 illustrates electrical activity in the cardiovascular system due to neuronal control system.

FIG. 16 illustrates a framework for analyzing the endovascular electrography signals, according to an embodiment of the present invention.

FIG. 17 illustrates several embodiments for electrogram waveform processing.

FIG. 18A shows ECG leads arranged to form an Einthoven triangle.

FIGS. 18B-18F show various views of a skin ECG waveform and an endovascular ECG waveform as depicted on a graphical user interface according to one embodiment.

FIGS. 19A and 19B show various views of a skin ECG waveform and an endovascular ECG waveform as depicted on a graphical user interface according to one embodiment.

FIGS. 20A and 20F show various views of a skin ECG waveform and an endovascular ECG waveform as depicted on a graphical user interface according to one embodiment.

FIGS. 21A and 21B show various views of a skin ECG waveform and an endovascular ECG waveform as depicted on a graphical user interface according to one embodiment.

FIGS. 22A-22D show various magnetic sterile connectors according to certain embodiments.

FIGS. 23A and 23B show various steerable sterile connectors according to certain embodiments.

FIGS. 24A-24F show various views of a skin ECG waveform and an endovascular ECG waveform together with a heart icon to indicate a position of an endovascular device as depicted on a graphical user interface according to one embodiment.

FIGS. 25A and 25B show various possible depictions for use in ECG signal-based guidance as displayed on a mobile phone according to one embodiment.

FIG. 26 shows a depiction of the zooming of multiple ECG waveforms as displayed on a mobile phone according to one embodiment.

FIGS. 27A and 27B show additional ECG waveform-related depictions as displayed on a mobile phone according to one embodiment.

FIG. 28 is a view of skin and endovascular ECG waveforms together with additional elements as depicted on a graphical user interface according to one embodiment.

FIG. 29 is a view of skin and endovascular ECG waveforms together with additional elements as depicted on a graphical user interface according to one embodiment.

FIG. 30 is a view of skin and endovascular ECG waveforms together with additional elements as depicted on a graphical user interface according to one embodiment.

FIG. 31 is a view of skin and endovascular ECG waveforms together with additional elements as depicted on a graphical user interface according to one embodiment.

FIG. 32 is a view of skin and endovascular ECG waveforms together with additional elements as depicted on a graphical user interface according to one embodiment.

FIG. 33 is a view of skin and endovascular ECG waveforms together with additional elements as depicted on a graphical user interface according to one embodiment.

FIG. 34 is a view of skin and endovascular ECG waveforms together with additional elements as depicted on a graphical user interface according to one embodiment.

FIG. 35 is a view of skin and endovascular ECG waveforms together with additional elements as depicted on a graphical user interface according to one embodiment.

FIG. 36 is a table showing various ECG waveform energy values and ratios according to one embodiment.

FIG. 37 is a graph showing energy vs. location for an endovascular ECG electrode and a skin ECG electrode.

FIG. 38 is a simplified view of a heart and proximate vasculature showing various possible locations for positioning a catheter or other medical device.

FIG. 39 is a view of a Doppler ultrasound signal, including various peaks and a region of interest, according to one embodiment.

DETAILED DESCRIPTION OF SELECTED EMBODIMENTS

Reference will now be made to figures wherein like structures will be provided with like reference designations. It is understood that the drawings are diagrammatic and schematic representations of exemplary embodiments of the present invention, and are neither limiting nor necessarily drawn to scale.

For clarity it is to be understood that the word "proximal" refers to a direction relatively closer to a clinician using the device to be described herein, while the word "distal" refers to a direction relatively further from the clinician. For example, the end of a catheter placed within the body of a patient is considered a distal end of the catheter, while the catheter end remaining outside the body is a proximal end of the catheter. Also, the words "including," "has," and "having," as used herein, including the claims, shall have the same meaning as the word "comprising."

Embodiments of the present invention advantageously provide an inventive apparatus(es), computer-based data processing algorithms and methods for obtaining and using endovascular ECGs in a number of clinical applications and settings. For example, once device can be used to guide endovascular devices in and around the heart, e.g., guiding central venous access devices in the superior vena cava, right atrium, and right ventricle. Such central venous access devices may include central venous catheters (CVC), peripherally inserted central catheters (PICC), implantable ports, hemodialysis catheters, tunneled catheters and others. Other devices which may benefit from guidance with the inventive apparatus are temporary pacemaker leads placed through the central venous system. Catheters and guidewires used in left heart procedures may also benefit from the embodiments described herein by decreasing the amount of contrast and radiation required to guide these devices in position. In another example, the apparatus can be used for minimally invasive monitoring and assessing heart conditions based on its electrical activity, e.g., assessing preload in a heart cycle or monitoring ST segments and T-waves in congestive heart failure.

In one aspect, an apparatus is described consisting of sterile adaptors, an electronic module for signal acquisition, a computer module, software, and peripheral devices and connections. In one embodiment, the electronic module for signal acquisition can be dedicated to acquiring and processing endovascular electrical signals generated by the body (endovascular ECG), in another embodiment the electronic module can be dedicated to acquiring and processing endovascular ECGs as well as skin ECGs.

In one embodiment, the electronic module and the computer module can be separate modules, in another embodiment they can be integrated in the same module and enclosure, and yet in another embodiment they can communicate with each other via a wireless connection, such as Bluetooth. In one embodiment, the apparatus can contain an integrated printer, while in another embodiment the printer can be external and attached to the apparatus and the apparatus connected via network, e.g., wireless to other devices. In yet another embodiment the apparatus can be used for telemetry and for transmitting the endovascular electrograms to a remote location, e.g., via a telephone line, Internet, and/or wireless phone. Any combination of embodiments mentioned above is also possible.

In another aspect, various configurations allow the connection of endovascular devices, such as central venous access devices, to the electronic module for signal acquisition and processing. In one embodiment, the device consists of a connecting wire with two ends and special connectors at each end. At one end, the wire can be connected to a metal or nitinol guidewire or stylet as commonly available on the market. At the other end, the wire can be safely connected to the electronic module. In another embodiment, the device includes a coated guidewire, e.g., made of nitinol or stainless steel with uncoated distal and proximal ends and cm markings. In such an embodiment, the coated guidewire is inserted endovascularly, while the connecting wire is connected to the proximal end of the coated guidewire. In another embodiment, the device includes a catheter-syringe adaptor provided with an electrical connecting wire. At one end, the electrical connecting wire is in contact with the fluid, e.g., saline flowing within the catheter-syringe adaptor. At the other end the connecting wire can be connected to the electronic module.

In another aspect, various electrode configurations allow for the optimal acquisition of endovascular ECGs. In one embodiment, a single lead is used to provide information about the tip location of an endovascular device within the vasculature. In another embodiment a modified three lead configuration is used to provide simultaneous 3-lead monitoring of the heart activity at the same time with providing tip location information. In another embodiment a modified single lead configuration plus ground is used for telemetry and transferring information from the tip of the catheter remotely.

In another aspect, algorithms are introduced for the analysis of the ECG waveforms and for supporting decision making based on these waveforms. These algorithms discriminate between different locations in the vasculature and assess body functions (systemic and at specific locations in the body), in particular heart functionality. In various embodiments, these algorithms use time domain analysis of waveforms: morphologic, for example shape; statistic, for example behavior.

In other embodiments, the algorithms use frequency domain analysis of waveforms: morphologic, for example shape; statistic, for example behavior. In further embodiments, signal energy analysis in time and frequency domains is also performed, morphologic and statistic. Fuzzy, statistical, and knowledge-based decision making are also contemplated by the present embodiments as decision support tools.

In another aspect, a user interface is provided that advantageously simplifies interpretation of data and workflow. In one embodiment the user interface includes simplified graphics showing the location in the vasculature and in the heart of the tip of the endovascular device in use without

showing any of the ECG waveforms. In another embodiment, the user interface shows, in real-time, the change in location of the tip of the endovascular device in use.

In another aspect, several inventive methods are presented which use the apparatus described herein in clinical applications. In one embodiment, a computer-based method is provided that guides central venous catheters (CVC, PICCs, hemodialysis, implantable ports, and others) using stylets, guidewires and saline solution to the superior vena cava, inferior vena cava, the right atrium, and the right ventricle. This method is advantageously less sensitive to patients with arrhythmias than the prior art, and represents an alternative to chest X-ray confirmation of tip location of central venous catheters in most clinical cases. In another embodiment, a computer-based method is provided that guides coated guidewires in the right and left heart. In another embodiment, a computer-based method is provided that guides the placement of temporary pacemaker leads through the central venous system. In another embodiment, a method is provided that is minimally invasive and monitors preload using depolarization and heart rhythms. In another embodiment, a method is provided that is minimally invasive and monitors arrhythmias using P-wave analysis. In another embodiment, a method is provided that is minimally invasive and monitors heart failure using ST segment and T-wave analysis.

In another aspect, one or several skin electrodes are used to obtain skin surface ECG signals simultaneous with the acquisition of endovascular (intracavitary) electrogram (ECG) signals via the use of endovascular (intracavitary) electrodes. The simultaneous and synchronized skin surface and endovascular ECG signals are used in one of several ways to analyze and quantify the ECG signals as a function of the location of the endovascular electrode, e.g. as a function of the tip of a catheter.

In light of the above, in one embodiment the ease-of-use of the ECG-based catheter navigation and tip location is enhanced. In one aspect, for instance, skin ECG reference waveforms are simultaneously presented on a display with endovascular ECG waveforms measured at the tip of a catheter or other indwelling medical device. Such simultaneous acquisition and display of concurrent ECG signals allows for ready interpretation of the endovascular ECG waveform at the tip of the catheter. In another aspect, a skin ECG reference signal is used to synchronize information processing algorithms applied to the endovascular ECG signal, yielding results of enhanced reliability concerning changes of P-wave of the endovascular ECG signal in terms of shape and energy.

In another embodiment, analysis of the synchronized skin and/or endovascular ECG signals can be linked to one another and/or to the periodic electrical activity of the heart. For example, a skin ECG lead can be used to detect the R-peak of the QRS complex of a detected skin ECG waveform. Detection of the R-peak in the skin ECG waveform can be used to trigger analysis of the endovascular ECG signal in a simultaneously corresponding segments of the endovascular ECG waveform, e.g., in the segment corresponding to the P-wave. Such triggering is particularly useful in case of arrhythmia, wherein the skin ECG waveform does not typically demonstrate a consistent P-wave, while the endovascular ECG waveform indeed includes a detectable P-wave segment that changes as a function of the location in the vasculature.

In other embodiments, magnetic and steerable sterile connectors are disclosed, as well as aspects of display and

control solutions to enable a mobile phone or other handheld device to control an ECG-based system including one or more of the above aspects.

In yet another embodiment, a method is disclosed for locating an indwelling medical device within a vasculature of a patient. The method comprises identifying an endovascular ECG waveform complex from an endovascular ECG signal associated with the indwelling medical device, then calculating an absolute value of the energy of the endovascular ECG waveform complex over a predetermined segment thereof. A position of the medical device within the vasculature is then determined by observation of the absolute value of the energy of the predetermined segment of the endovascular ECG waveform complex.

FIG. 1A is a block diagram that depicts an apparatus according to an embodiment of the present invention.

The apparatus **100** can be attached through an adaptor (**120**) to a large variety of commercially available and custom designed vascular access devices (**110**). Examples of such devices are: central venous catheters (CVC), peripherally inserted central catheters (PICC), implantable ports, tunneled catheters, hemodialysis catheters, guiding catheters for pacemaker leads, guidewires used for coronary and other vascular interventions, guiding catheters for coronary and other vascular interventions, stylets, syringe needles, and others. If the vascular access devices is a stylet, a guidewire, or a syringe needle, its material must be sufficiently electrically conductive, e.g., stainless steel or nitinol. In such a case the hook or the alligator clip adaptor according to one embodiment should be used. If the vascular access device is a catheter, than saline should be used to establish a conductive path through one of the catheter's lumens. In such a case, the syringe-catheter adaptor according to one embodiment should be used.

The electronic module (**130**) receives electrical signals from the adaptor and from one or more other electrodes placed on the patient's skin (**115**). Alternatively, more than one adaptor can be used at the same time to connect to more than one endovascular device in order to provide different electrical signals to the electronic module. The use of skin electrodes is optional in certain device configurations. The electronic module processes the electrical signals and transmits them to a computer module (**140**) for further processing and other functions. In one embodiment, the electronic module and the computer module can be packaged separately, and in another embodiment they can be integrated in the same package. In one embodiment, the connection between the electronic module and the computer module can be hardwired (**131**), and in another embodiment the connection it can be wireless (**132**), e.g., using Bluetooth. In one embodiment the computer module (**140**) can be a notebook or a netbook, and in another embodiment the computer module can be a PDA or a mobile phone, e.g., an iPhone or an iPad.

The computer module processes the signals from the electronic module applying algorithms (**170**) as described by current embodiments. The computer module can also be connected to peripherals (**160**), e.g., a printer or a label printer and storage devices and provides connectivity including wireless connectivity (**150**) to other computers or to the internet. The storage device can be used to store a database of knowledge and information regarding the application at hand. The connectivity interface can be used to update this database remotely with newest relevant knowledge and information, e.g., new clinical cases, new findings regarding the relationship between electrograms and heart

conditions. The computer module supports a graphical user interface (180) optimized for the purpose of the clinical application at hand.

FIG. 1B is a block diagram of an electronic module (2) for acquisition and processing of endovascular electrocardiogram according to an embodiment of the present invention.

The patient connector interface (10) allows for connecting electrical leads to the patient (5). Any combination of skin electrodes and/or electrical connections to endovascular devices using the adaptors discussed above can be used. In one embodiment, the amplifier (20) is a four stage amplifier with variable gain, which can amplify electrical signals coming through the patient cable, for example, typical of electrocardiographic values. The analog-to-digital converter (30) converts the signals in digital format readable by the micro-processor (40). Any number and configurations of microprocessors, microcontrollers, and digital signal processors can be used to implement the micro-processing function (45).

In one embodiment, a microcontroller is responsible for controlling the serial communication with a computer module (90) via the serial interface (70) or via the wireless interface (80) and a digital signal processor (DSP) is responsible for implementing one or several of the inventive algorithms described herein. Alternatively, a single processor (46) can be used for both communication and processing.

The micro-processor (40) also receives commands from the computer module (90) and controls different elements of the electronic module, e.g., the amplifier (20) accordingly. The patient isolation block (50) decouples electrically the power (60) and the serial communication channel (70) from the patient interface (10) in order to ensure patient protection to electrical shock. In one embodiment the isolation block (50) can consist of a transformer and/or couplers, e.g. optical couplers.

FIG. 2 depicts an adaptor (200) for an endovascular device according to an embodiment of the present invention. Vascular access devices like catheters, syringes, syringe needles, stopcocks, infusion pumps and others connect to each other through standard connections. For example, in FIG. 2 such a standard connection between two devices is illustrated on device (201) by the luer (202) with inner diameter (203) and outer diameter (204), and on device (250) by threaded port (251) with inner diameter (252) and fluid opening diameter (253). The threaded port (251) and the luer (202) allow for connecting the two devices (201, 250) by threading, attaching, coupling, etc., the port (251) into the luer (202).

The adaptor (200) has a body (220) with two ends (226, 227) with a length (225), and is made, for example, of strong biocompatible plastic material with some degree of elasticity. End (227) has a shape of a cone. In one embodiment, end (227) has an elastic sealing portion (228) such that end (227) can easily fit in the luer (202) of device (201) to seal the connection for fluid flow. The other end (226) is in the shape of a standard luer with diameter (224), such as, for example, luer (202) of device (201). The threaded port (251) of the device (250) can be connected to end (226) of the adaptor (200). The cone piece (270) also allows a connection to a device that does not have a luer. The stand alone cone piece (270) allows a connection between two devices with different accessible diameters. The end (227) of adaptor (200) has a diameter (223) and fits inside the diameter (272) of the cone piece (270). The end (271) of the cone piece (270) fits in a simple catheter end portion (261) with a diameter (262) of a typical device (260). For example, device (260) can be a catheter for an implantable port.

In one embodiment, device (201) is a syringe needle, and device (250) is a syringe. Fluid, e.g., a conductive electrolyte, flows through adaptor (200) through a central inner bore or lumen (222) having a certain diameter, and provides a fluid path between the devices (250, 201). A conductive metal ring (240) is attached to a portion of the substantially cylindrical surface of lumen (222) and, preferably, induces very little perturbations to the fluid flow. For example, the metal ring (240) may be disposed within a recessed portion of the substantially cylindrical surface of the lumen (222). One end (230) of a conductive wire (233) is electrically coupled to the metal ring (240); in one embodiment, the end (230) is soldered to metal ring (240). In another embodiment, the end (230) is captured between the surface of the lumen (222) and the metal ring (240), and the end (230) and the metal ring (240) maintain good electrical contact through mechanical pressure. The wire (233) may be bare or insulated. In a preferred embodiment, the metal ring (240) is fixedly attached to the surface of lumen (222) using, for example, adhesive, an interference fit, a press fit, etc., while in other embodiments, the metal ring (240) may be removably attached to the surface of lumen (222), free-floating, etc.

The wire (233) passes through a channel (231), which extends from the lumen (222) to an opening in the outer surface of the body (220). Epoxy (232), or other suitable material, may be used to seal the opening of the channel (231), as well as to provide a strain relief for the wire (233). The metal ring (240) may be advantageously disposed adjacent to the channel (231) to provide additional sealing. Thus, the metal ring (240), the wire (233), the channel (231) and the epoxy (232) provide a sealed, electrical connection to the fluid flowing through the adaptor (200). A connector (234) may provide a standard electrical connection to the electrography system; a non-terminated wire may also be used. In one embodiment, the wire (233) terminates at the opening of the channel (231) and the connector (234) is attached directly to the body (222), while in another embodiment, the wire (233) extends through the opening of the channel (231) and the connector (234) is attached to the free end of the wire (233).

In one embodiment, the substantially cylindrical surface of lumen (222) is tapered along the longitudinal direction (221). This taper may extend along the entire length of lumen (222), or restricted to a certain portion thereof. For example, the surface of lumen (222) may be cone-shaped and have a larger diameter at the proximal end, or, alternatively, the larger diameter may be located at the distal end.

In one example, device (201) is a syringe needle that is inserted into a lumen of a catheter for an implantable port, and device (250) is a syringe. The syringe is filled with saline, which is then injected into the catheter through the adaptor (200). Thus, the adaptor (200) becomes filled with saline solution, and, because the conductive metal ring (240) is in contact with saline and the conductive wire (233), an electrical connection is established between the catheter lumen and the wire (233). In this way, the electrical signal at the tip of the catheter may be measured through the saline solution. Other electrically conductive solutions may also be used to obtain the endovascular electrogram using the adaptor (200). In another embodiment, the adaptor (200) may be used with infusion pumps, as well as other types of power injections. In an alternative embodiment, the adaptor (200) does not include the metal ring (240), and the electrically conductive ending (230) is in direct contact with the electrolyte.

FIG. 3 illustrates a catheter steering device according to an embodiment of the present invention. In this embodiment, the catheter (300) is a triple lumen catheter and the distal end of each of the lumens is spaced with respect to each other. The catheter steering device can be used with any catheter having two or more lumens with spaced distal lumen openings. The open end of one lumen (306) of catheter (300) is at the very distal end of the catheter, another end or opening of a lumen (305) is spaced back from the distal end and the end or opening of the third lumen (307) is spaced back compared to the second end (305). The distance between the open end (306) and the end (307) is typically from one to several centimeters.

Several types of catheters have multiple lumens with spaced ends, and the inventive steering device can accommodate such catheters. For example, in the case of a peripherally inserted central catheter, the typical length of a catheter is 50 to 60 centimeters and the spacing between the distal lumen ends (305, 306, and 307) is from one to several centimeters. A hemodialysis catheter with two lumens can typically be 20 to 40 centimeters in length, with one to several centimeters spacing between the distal ends of the two lumens. A multi-lumen central venous catheter (CVC) can typically be 15 to 25 cm in length with spacing between distal ends or openings of the lumens being from several millimeters to several centimeters.

At the proximal end, the catheter has a catheter hub (301) which splits the three lumens and connects each of them with a luer (302, 303, 304). The inventive catheter steering device includes a stylet (310) with a handle (311) at the proximal end to allow for pushing, pulling, and removal after use, and a steering member (320) which connects to the distal end of the stylet (322) and which can be fed back into a distal lumen opening of one of the other lumens, such as, for example, lumen (307). The steering member (320) returns to the proximal end of the catheter through the catheter lumen and exits at the proximal end through the luer corresponding to the respective lumen (304). So disposed, the steering device is in the installed position. In one embodiment, the member (320) has a handle (321) which can be used to pull the member through the lumen. In another embodiment, the handle (321) is detachable from the member (320).

The member (320) may be polyurethane, silicone, PTFE, or other similar materials. In different embodiments, the member (320) may be any kind of biocompatible thread, e.g., surgical thread. In another embodiment, the member (320) is stainless steel wire. In one embodiment, the stylet is provided pre-inserted into one of the catheter lumens, typically the central lumen with the most distal opening (306) with the member 320 attached at the distal end of the stylet (322) and pre-inserted into the lumen (304) through the lumen opening (307). In order to steer the catheter, the user pulls the member 320 out of the catheter while preventing the stylet 310 to be pulled into the catheter. Thus, the catheter tip can be bent in a desired direction. This situation is illustrated by the bent catheter tip (350), the member (340) which was pulled back and the member (330) which is its initial position with respect to the catheter. If the stylet (310) or the steering member (320), or both are made of any electrically conductive material, then each or both of them can be used to measure electrical signals or endovascular electrograms at the distal tip of the catheter by connecting their proximal ends to the endovascular electrography system. In one embodiment, the steering member (320) can be tied to the stylet (310) through the opening (307) of the catheter lumen.

In another embodiment, the stylet (310) and the steering member (320) are manufactured as a single component to form an extended steering member that is looped back through the opening (305) of a different catheter lumen. By pulling one of the two ends of the extended steering member coming out through luers (304) and (302), the same effect is achieved and the catheter tip can be bent in a desired direction. In another embodiment, in the case of a double lumen catheter, the stylet (310) can be inserted in one lumen and the steering member (320) can be inserted in the other lumen, such that the effect of bending the catheter tip can be achieved by pulling the proximal ends. In a further embodiment, the steering member (320) can be inserted in the lumen (302) and through the opening (305).

FIGS. 4A, 4B, 4C, and 4D depict electrode configurations that provide optimal acquisition of endovascular electrocardiogram according to various embodiments of the present invention.

FIG. 4A depicts a single lead configuration with a reference electrode (410), for example attached to the patient's skin over the right arm and with the other electrode attached through an adaptor to an endovascular device (415). The reference electrode attached to the skin over the right arm is presented in this configuration for illustration purposes only. Other locations of the reference electrode are possible depending on the type of ECG required. The reference electrode over the right arm together with the tip of the endovascular device used with the adaptor can be similar to lead II of a standard ECG. In this case the ECGs obtained from the superior vena cava (401) and inferior vena cava (402) can be optimized. The reference electrode can be attached to the skin in any other location in order to simulate other leads of the standard ECG. The reference electrode can be also connected to adaptors attached to other endovascular devices in order to obtain more local information from within the patient's heart (400).

FIG. 4B depicts a modified 3-lead configuration, with monitoring and guiding capabilities, with 4 electrodes. Three (3) electrodes correspond to the standard ECG electrodes: right arm (RA, 420), left arm (LA, 425), and left leg (LL, 430) used as reference. The fourth electrode is attached through an adapter to the endovascular device (C, 435). In this configuration, the electronic module and the algorithm perform two functions simultaneously: the three standard electrodes (RA, LL, and LL) perform a monitoring function of the heart, while the C electrode (435) allow for recording the ECG at the tip of device.

FIG. 4C depicts a telemetry configuration with a single grounded lead, including the configuration illustrated in FIG. 4A and a ground reference (450). This configuration can be used to transmit ECGs remotely through a telemetry system configuration.

FIG. 4D depicts one use of ECG monitors for guiding endovascular devices. A standard ECG monitor is used having standard inputs RA (465), LA (460), and LL (470). LA (460) is connected to the left arm and LL (470) to the left leg of the patient. The RA input (465) is connected to a switch which can be used by the clinician to switch the RA input (465) between the RA electrode and the catheter (C) electrode 475. Thus either monitoring or guiding of catheter placement can be achieved alternatively.

FIG. 5 illustrates exemplary electrocardiogram signal amplitudes at different locations in the central venous system.

The heart (504), right atrium (501), superior vena cava (SVC) (502), and the inferior vena cava (IVC) (503) are illustrated. Location A is in the upper SVC, location B is in

the lower third of the SVC, location C is at the caval-atrial junction, location D is in the right atrium, and location E is in the upper inferior vena cava.

Graph 510 illustrates an ECG waveform as a function of time at recorded at location A. The absolute amplitude of the waveforms is recorded on an amplitude scale (590). In the case of an endovascular ECG, the standard elements of the electrocardiogram are illustrated: the P-wave (560), the R-wave (570), and the T-wave (580). The amplitudes and shape at location A recorded with a lead configuration as in FIG. 4D are similar to an electrocardiogram recoded at the skin level with the same electrode configuration.

Graph 520 illustrates an endovascular ECG depicted at location B. The amplitude at this location is higher than the one at location A but the overall shapes of the waveform are similar at location A and B.

Graph 530 illustrates an endovascular ECG depicted at location C. At location C at the caval-atrial junction, the amplitude of the waveform is yet higher than the one at location B and the P-wave has dramatically changed becoming higher than the R-wave. This waveform is an indication of the proximity of the sino-atrial node.

Graph 540 illustrates an endovascular ECG depicted at location D. At location D in the right atrium, the amplitudes are similar to location C but the P-wave changes polarity becoming bi-polar. This is an indication that the measurement of the ECG occurs beyond the sino-atrial node.

Graph 550 illustrates an endovascular ECG depicted at location E. At location E in the inferior vena cava, the waveform is similar to the one at location A in terms of amplitude except the P-wave has reverse polarity. The differences in the ECG waveforms at different locations are used by the algorithms introduced herein to discriminate between the corresponding locations and to assess heart and blood vessel functionality.

FIG. 6 illustrates exemplary electrocardiogram signal power spectra at different locations in the central venous system, using a spectral scale (690).

The heart (604), right atrium (601), superior vena cava (SVC) (602), and the inferior vena cava (IVC) (603) are illustrated. Graph 610 illustrates an endovascular ECG spectrum depicted at location A. At location A, the spectrum (610) has the appearance of a single central frequency or single band (660) and with a frequency distribution spectral power and energy similar to those at skin level.

Graph 620 illustrates an endovascular ECG spectrum depicted at location B. At location B the frequency distribution has two major bands and a higher energy and spectral power than the one at location A.

Graph 630 illustrates an endovascular ECG spectrum at location C. At location C, there are multiple (3-4) major frequencies or principal spectral components distributed over a wider range of frequencies (670). This spectral distribution is indicative of the energy distribution around the sino-atrial node. The spectral power and signal energy have increased compared to location B.

Graph 640 illustrates an endovascular ECG spectrum depicted at location D. At location D the spectrum is wider and more broadband indicative of the electrical activity of the right atrium.

Graph 650 illustrates an endovascular ECG spectrum depicted at location E. The frequency spectrum at location E is similar to the one at location A. The differences in the spectral waveforms at different locations are used by the algorithms introduced herein to discriminate between the corresponding locations and to assess heart and blood vessel functionality.

FIG. 7 illustrates exemplary electrocardiogram signal electrical energy distribution at different locations in the central venous system. The heart (704), right atrium (701), superior vena cava (SVC) (702), and the inferior vena cava (IVC) (703) are illustrated. Graphs (710, 720, 730, 740, 750) depict the energy distribution at different locations (A, B, C, D and E, respectively) and the changes in time are used by the algorithms introduced herein to discriminate between the corresponding locations and to assess heart and blood vessel functionality.

Considering FIG. 16 for a moment, a framework for analyzing the endovascular electrography signals according to an embodiment of the present invention is illustrated. The heart is represented by (1600), the superior vena cava by (1601), the inferior vena cava by (1602) and the right atrium by (1603). In this embodiment, there are three regions of interest for placing central venous access devices: the lower third of the superior vena cava or SVC (1605), the caval-atrial junction or CAJ (1606), and the upper right atrium or RA (1607).

The graph (1620) illustrates the electrical energy profile as a function of location in the heart and the graph (1640) illustrates the different electrography waveforms which can be obtained at different locations in the heart. The curve (1630) illustrates the increase of electrical energy detected in each of the regions at the tip of an endovascular catheter advancing from the superior vena cava into the heart. In one embodiment, the energy curve is calculated in time domain, while in another embodiment, the energy curve is calculated in the frequency domain using the frequency spectrum. In one embodiment, the energy is calculated for the actual signal levels, while in another embodiment, the baseline value or other mean values are first subtracted from the signal values before energy calculations. The signal energy or power is calculated in time domain by summing up the squared amplitude values before and/or after baseline subtraction over a determined period of time, e.g., a heartbeat. In the frequency domain, the signal energy or power is calculated by summing up the squared values of the frequency components. In one embodiment, the curve is calculated using the entire electrogram, while in other embodiments, only certain segments of the electrogram are used for the energy calculations, e.g., only the segment corresponding to a "P-wave" of an electrocardiogram. Such a "P-wave" segment is representative of the electrical activity of the sino-atrial node.

Different levels of energy characterize the different locations along the catheter path from the SVC to the heart. These regions can be differentiated in terms of their electrical energy level by using thresholds. Threshold (1631) of energy level defines the beginning of the lower third of the superior vena cava. The energy levels (1621) define the regions in the vasculature of low energy which are distant or further away from the sino-atrial node. The energy levels (1622) between thresholds (1631) and (1632) define the region labeled as the lower third of the superior vena cava (1625 and 1605). The energy levels (1623) between thresholds (1632) and (1633) define the region labeled as the caval-atrial junction (1626 and 1606). The energy levels (1624) between thresholds (1633) and (1634) define the region labeled right atrium (1627 and 1607).

Similarly, the shape and size of the electrogram in graph (1640) relative to a baseline (1650) can be correlated to a location in the heart. Thresholds (1631), (1632), (1633), and (1634) are determined specifically for the type of energy considered for calculations, e.g. the entire electrogram, the P-wave, and/or the S-T segment. Before the lower third of

the SVC and corresponding to a relatively low level of energy (1621), the P-wave (1651) and the R-wave (1652) are similar in size and shape with a standard electrocardiogram lead II recorded at the skin level if the right arm standard ECG lead is connected to the catheter and measuring the electrogram signal at the tip of the catheter. In the lower third of the SVC (1605 and 1645), the energy level of the electrogram increases, the electrogram amplitudes increase and the P-wave (1653) increases amplitude and energy relative to the R-wave (1654) to where the P-wave amplitude and energy between half and three quarters of the amplitude and energy of the R-wave. At the caval-atrial junction (1606 and 1646), the energy level of the electrogram increases further, the electrogram amplitudes continue to increase and the P-wave (1655) increases amplitude and energy relative to the R-wave (1656) to where the P-wave amplitude and energy are larger or equal to the amplitude and energy of the R-wave. In the right atrium (1607 and 1647), the energy level of the electrogram increases further, the electrogram amplitudes increase, the P-wave (1657) becomes bipolar and its amplitude and energy relative to the R-wave (1658) start decreasing. These behaviors are quantified, analyzed, and used in order to provide location information regarding the tip of the catheter.

Considering FIG. 17 for a moment, several electrogram waveform processing embodiments are illustrated. Graphs (1710) and (1720) illustrate a P-wave analysis embodiment. Since the P-wave corresponds to electrical activity of the heart generated by the sino-atrial node, the changes of the P-wave are most relevant with respect to determining the proximity of the sino-atrial node in an endovascular approach. Therefore, in order to assess proximity of the sino-atrial node and location in the vasculature, signal analysis methods in time and frequency domains, as well as signal energy criteria can be applied only to the P-wave segment of an electrogram. In graph (1710), the segment designated for the P-wave analysis (1711) starts at moment (1713) and ends at moment (1714). During the period of time between the starting moment and the ending moment of the P-wave segment, the highest amplitude detected corresponds to the P-wave peak (1712). The starting moment (1713) of the P-wave segment analysis can be determined in a number of ways. In one embodiment, the heart beat is calculated and the R-peak is detected as the maximum amplitude of the heart beat. Going back from each R-peak a certain percentage of the heart beat, for example between 20% and 30%, determines the moment when the analysis of the P-wave starts (1713). Going back 2% to 5% of the heart beat from each R-peak determines the end of the segment designated for the P-wave analysis (1714). Similarly, in graph (1720), the designated segment for the P-wave analysis (1721) starts at moment (1723) in the heart cycle and ends at moment (1724). The P-wave in this case is bipolar with a positive maximum amplitude (1722) and a negative maximum amplitude (1725) when compared to the baseline (amplitude equals zero). For the P-waveform defined between the starting point (1713 on graph 1710 and 1723 on graph 1720) and the end point (1714 on graph 1710 and 1724 on graph 1720) time-domain and frequency-domain algorithms are applied according to embodiments of the present invention.

Graph (1730) illustrates the advantages of baseline subtraction prior to signal energy computation. If the signal energy is calculated in time domain as the sum of the squared signal amplitudes over a heartbeat, then the amplitude variations between levels (1731 and 1732) around baseline (1733) may lead to a lower energy level than the

signal with amplitude variations between levels (1734 and 1735) whereby the level (1734) is the baseline. The baseline value (1733) is subtracted from the amplitude values (1731 to 1732) and the baseline value (1734) is subtracted from the amplitude values (1734 to 1735). After subtracting the baseline, the sum of squared amplitude values is calculated. Thus, this sum is proportional to the energy of signal variation around the baseline and therefore it is more appropriate to characterize changes in the signal values/behavior.

Graph (1740) shows a typical electrogram waveform with a P-wave (1741) and an R-wave (1742) and a distorted signal with the P-wave covered by high frequency noise (1744) and the R-wave saturated to a maximum value (1743). In the presence of these kinds of artifacts (1744 and 1743) it is very difficult and sometimes impossible to recover the original signal (1741 and 1742). Therefore, according to embodiments of the present invention, an algorithm is used to detect the presence of artifacts and reduce the amount of artifacts as much as possible. If, after reducing the artifacts, the signal cannot be recovered, then the signal is discarded for the computation of signal energy. The presence of artifacts can be detected in time domain by a high value of the derivative and of its integral, a jump in signal energy, a jump in the value of the baseline or in different averages calculated from the signal. In frequency domain, the artifacts can be detected as a jump in the value of the DC component (frequency zero of the spectrum), as the sudden appearance of high frequency components, and in a jump of the spectral power/energy. In the frequency domain, selective filtering can be applied and all components removed, which are not "typical" for the average behavior of the signal. After selective filtering, the signal is reconstructed in the time domain using an inverse Fourier transform in order to allow for verification of the success of the selective filtering.

FIG. 8 depicts a graphical user interface according to an embodiment of the present invention.

Window (810) presents the ECG waveform in real-time as it is acquired by the electronic module using the attached electrode configuration. Window (820) is a reference window and shows a frozen waveform used to compare with the current window. In one embodiment, the reference waveform in window (820) can be obtained through the electrodes connected to the electronic module at a reference location of the catheter and/or using a reference configuration of the skin electrodes. For example, such a reference waveform can be the ECG recorded using an adaptor according to an embodiment of the present invention connected to an endovascular device placed at the caval-atrial junction. In a different embodiment, the reference waveform in window 820 can be a typical waveform at a certain location in the vasculature or of a certain heart condition as it is recorded in a database of waveforms and as it is stored in the storage medium of the computer system. If the electrode configuration allows for simultaneous heart monitoring and recording of electrograms using an endovascular device, window (830) shows one of the standard ECG leads for heart monitoring, while window (810) shows the ECG at the tip of the endovascular devices when connected to an adaptor, such as the ones discussed above.

The icon (870) is a representation of the heart, and the locations A through E (875) illustrate different locations in the heart and vascular system which can be discriminated by analyzing endovascular ECGs in accordance with the methods disclosed herein. As a location in the vasculature is identified by the algorithms, the corresponding place and letter on the icon (875) becomes highlighted or in some other

way is made visible to the user. The bars (884), (885), and (886) show signal energy levels. The “E” bar (885) presents the amount of electrical energy computed from the ECG frequency spectrum at the current location of the tip of the endovascular device. The “R” bar (884) presents the amount of electrical energy computed from the ECG frequency spectrum at a reference location. The “M” bar (886) presents amount of electrical energy computed from the ECG frequency spectrum using the monitoring ECG signal from the skin electrodes. The window (840) depicts monitoring information, e.g., heart rate. Patient information (name, date of procedure and others) are shown in window (850). Window (860) contains system control elements like buttons and status information, e.g., scale, scroll speed, system parameters and system diagnostics.

FIG. 9 depicts a graphical user interface according to another embodiment of the present invention.

The icon (920) is a representation of the heart and the locations A through E (930) illustrate different locations in the heart and vascular system which can be discriminated by analyzing endovascular ECGs. As a location in the vasculature is identified by the algorithms, the corresponding place and letter on the icon (930) becomes highlighted or in some other way is made visible to the user. The bars (940), (950), and (960) show signal energy levels. The “E” bar (940) depicts the amount of electrical energy computed from the ECG frequency spectrum at the current location of the tip of the endovascular device. The “R” bar (950) shows the amount of electrical energy computed from the ECG frequency spectrum at a reference location. The “M” bar (960) shows amount of electrical energy computed from the ECG frequency spectrum using the monitoring ECG signal coming from the skin electrodes. The button “Print” (960) allows the user to print the information documenting the case on a printer, for example on a label printer for quick attachment to the patient’s chart.

FIGS. 10A and 10B depict exemplary printouts for the information displayed by the graphical user interface, according to an embodiment of the present invention.

FIG. 10A illustrates a printout (1000) for the case of a catheter tip placement procedure in the lower third of the SVC. The field 1010 depicts the heart icon whereby the letter “B” corresponding to the lower third of the superior vena cava (SVC) is highlighted (1040). Field 1030 depicts the reference ECG waveform recorded at the tip of the catheter at the caval-atrial junction in the proximity of the sino-atrial node. Field 1020 depicts the ECG waveform at the tip of the catheter in the position in which it was placed at the end of the procedure. For FIG. 10A, this location is in the lower third of the SVC and the ECG waveform corresponds to this location. The patient name (1001) and the date of procedure (1002) are also printed.

FIG. 10B depicts a similar printout (1050) except that the final position at the end of the procedure is at the caval-atrial junction at location C (1090) on the heart icon (1060). The “SA Node” field depicts the reference ECG waveform (1080), and the “Final Position” field (1070) shows that the catheter was placed with the tip at the sino-atrial node: the ECG waveform in final location is similar or even identical with the one in the reference location at the sino-atrial node (SA Node). It is known that the proximity of the SA Node indicates a location at the caval-atrial junction. These locations are sometimes considered identical by some clinicians.

FIG. 11 is a block diagram for a computer-based method (1100) for positioning an endovascular device in or near the heart using electrocardiogram signals.

The algorithms are applied to the input signal (1102) (ECG) acquired by the adaptor to the endovascular devices and, optionally, through skin electrodes as well. The Error Detection Block (1105) detects at least three types of error conditions/exceptions, such as, for example, when a defibrillator has been applied to the patient, when a pacemaker is firing excitation pulses and/or when a lead/electrode is off. These errors/exceptions may be handled differently, and the user may be informed about the presence of an exception and the way of handling the exception (1110).

The Pre-Processing block (1115) may amplify the signal, reduce noise, eliminate artifacts, etc. In one embodiment, rescaling the signal to the display range occurs under user control and is not automatic, as with most currently available ECG monitors. Thus, changes in the amplitude of the ECGs are easily noticed. A high-pass filter corrects the baseline and reduces such artifacts as respiratory artifact. Wideband noise suppression may be achieved using a selective filter, e.g., a wavelet transform. Electromagnetic interference with other equipment and the power grid may be suppressed by a notch filter (narrow band filter) centered at 60 Hz or 50 Hz to accommodate domestic or international power supplies. High frequency noise may be suppressed with a low-pass filter, which, in one embodiment, is implemented with variable length averaging, such as, for example, a running window corresponding to a heart cycle, an averaging of the ECG over several consecutive heart cycles, etc. The Adaptive Filtering block (1120) optimizes the filter coefficients by minimizing an error signal.

The Time-Domain Pattern Recognition block (1130) identifies elements of the ECG waveform, their relationship(s) and their behavior(s) in time. An important aspect of the time-domain pattern recognition algorithm in block 1130, as well as of the Frequency Domain Pattern Recognition block 1140, is data history. The ECGs are analyzed in real time for certain elements, and, for other elements, a data buffer with an appropriate buffer length is maintained in the memory of the electronic and/or computer modules in order to allow for historic data analysis and prediction based on this analysis. In one embodiment, the data history buffer is several seconds long allowing for the ECG signal corresponding to several heartbeats to be saved in the buffer. A double buffering technique allows the waveform in one buffer to be processed while the second buffer continues to store signals. Thus no signal data are lost while the waveform in one buffer is processed. After data processing on one buffer is completed, the results are sent to the Decision Support Algorithms (1150) and the two buffers switch roles. The length of the buffer accommodates the time duration of data processing in order to ensure that no data are lost. A similar double buffering technique is also applied to the data subject to Frequency Domain Pattern Recognition block (1140).

In the case of an endovascular ECG, elements of interest may include, but are not limited to, one or more of the following:

1. The P, Q, R, S, T, and U waves, their peaks, amplitudes and duration;
2. The duration of the P-R, S-T, and T-P segments/intervals;
3. The elevation of the S-T segment;
4. The variances of the P-P and R-R intervals;
5. The variance of the S-T and of the R-T intervals, etc.;
6. The peak-to-peak values of the P-wave and of the QRS complex;
7. The ratio of the P-wave and R-wave amplitudes and the ratio of the P-wave and QRS complex peak-to-peak amplitudes;

8. The polarity of the P-wave: single positive, single negative, or bipolarity;

9. The derivative of the P-wave, QRS-complex, and T-wave;

10. Temporal average of the R-R interval and the heart beat;

11. Maximum value of the P-wave amplitude/peak and of the P-wave peak-to-peak amplitude over a certain period of time;

12. Maximum value of the R-wave amplitude/peak and of the ORS complex peak-to-peak amplitude over a certain period of time.

In the time domain, additional computations include:

13. Baseline subtraction, for example for removing of respiratory artifacts and in order to allow for the analysis of changes with respect to the baseline;

14. Waveform averaging for noise reduction;

15. Signal energy computation in time domain as the sum of the squares of signal amplitudes (before and after baseline removal);

16. First derivative computations for estimation of signal changes and removal of high frequency artifacts;

17. Integral (sum) of the first derivative values;

In the frequency domain, additional computations include:

18. DC and quasi-DC component removal (equivalent to baseline subtraction and removal of respiratory artifact);

19. Selective filtering, i.e., the removal of certain frequencies associated with artifacts and noise, e.g., high frequency noise, muscle artifacts, changes in signal due to catheter and electrode handling, etc.;

20. Inverse Fourier transform for reconstructing the signal into the time domain.

Several techniques may be used to derive the information listed above from the ECG waveforms, including, but not limited to, one or more of the following:

1. "Peak detection;"

2. Computation of first derivatives;

3. Running averages along the signal in one heartbeat and along multiple heartbeats;

4. Adaptive thresholding;

5. Auto-correlation.

The Fast Fourier Transform in block (1125) performs a Fast Fourier Transform on a number of ECG samples stored in a buffer of a certain length, e.g., 256, 512, 1024, 2048 or more data samples. The Fourier Transform transforms the waveform from the time domain into the frequency domain.

The Frequency-Domain Pattern Recognition block (1140) illustrates various aspects of pattern recognition performed on the ECGs in the frequency domain, including, but not limited to, one or more of the following:

1. Principal components analysis, i.e., determination of the most significant elements of the frequency spectrum (similarly to determining the morphological elements of the electrograms, e.g., certain waves and segments in time domain);

2. Data compression in order to reduce the amount of computation based on the principal components;

3. Determination of the number and morphology of the principal components, in particular determination if the spectrum has only one, two or multiple main frequencies (frequency bands);

4. Calculation of the spectral power and of the signal energy from the frequency spectrum;

5. Running average along the frequency dimension over a single spectrum in order to reduce wideband noise;

6. Running average along several spectra in order to filter out artifacts;

7. Determination of additional morphological elements of the spectrum, e.g., the maximum frequency, the energy contained in the maximum frequency, the frequency histogram, i.e., what frequencies contain how much energy, the frequency of the highest significant maximum energy peak, etc.;

8. Calculation of behavior and averages over time of the principal components and other parameters determined from the spectral distribution, e.g., determining the maximum value of the signal energy and of the spectral power over a certain period of time;

9. Determine/estimate certain heart conditions based on the spectral analysis. This determination/estimation is also performed in more detailed in the decision support blocks 1150 and 1250.

Several decision support algorithms use the information provided by the time domain pattern recognition and frequency-domain pattern recognition algorithms. In one embodiment, block (1150) supports placing an endovascular device in either the lower third of the SVC or at the caval-atrial junction.

In particular, block 1150 is based on the concept of first reaching the caval-atrial junction during catheter placement. At the caval-atrial junction or near the sino-atrial node the P-wave and other electrical parameters reach a maximum value. At the caval-atrial junction the P-wave is unipolar. After reaching the sino-atrial node at the caval-atrial junction, i.e., the maximum value of the P-peak amplitude and spectral power, the catheter is pulled back several centimeters until the P-wave decreases to half the amplitude reached at the caval-atrial junction. At the location where the P-wave has decreased to half the amplitude as the caval-atrial junction, the catheter is considered to be in the lower third of the superior vena cava. The P-wave peak amplitude or peak-to-peak amplitude, as well as the spectral power, is used to map the location in the vasculature to the ECG waveform.

More particularly, after receiving an endovascular ECG signal associated with an endovascular device, the signal is processed, over a plurality of predetermined time periods, to calculate a P-wave amplitude and a spectral power for each predetermined time period. A maximum P-wave amplitude is then determined from the plurality of P-wave amplitudes, as well as an associated maximum spectral power from the plurality of spectral powers. The location at which these maximum values are determined is associated with a predetermined location in or near the heart, such as the caval-atrial junction. The location of the endovascular device is then calculated, for each predetermined time period, based on a ratio of the P-wave amplitude to the maximum P-wave amplitude and a ratio of the spectral power to the maximum spectral power, and the location of the endovascular device is then displayed to the user. Additionally, the polarity of the P-wave and the R-wave amplitude may also be used to determine the location of the endovascular device.

A single criterion or a combination of such criteria can be used to support decision making. In one embodiment, T1, T2, and T3 may be empirically established thresholds which are different for each patient, and the algorithm can use an adaptive loop to adjust the thresholds based on the current measurements. In another embodiment, these thresholds are predetermined.

In other embodiments, the ratio between the P-peak/P amplitude or the P-wave peak-to-peak amplitude to the R-peak/R amplitude or to the QRS complex peak-to-peak

amplitude can also be used to establish location relative to the sino-atrial node. In one embodiment the P-peak/amplitude must be approximately half of the R-peak/amplitude and the P-wave must be unipolar for the location to correspond to the lower third of the SVC. In another embodiment, the P-wave peak-to-peak must be half of the QRS peak-to-peak amplitude and the P-wave must be unipolar for the location to correspond to the lower third of the SVC.

As discussed above, the results of the decision support algorithms block **1150** may be presented to the user, for example, by highlighting the appropriate location on the heart icon corresponding to the type of ECG identified by the system (**1160**).

The decision support algorithm block **1250**, depicted in FIG. **12**, is based on comparing the P-wave, R-wave and P-wave spectral power at the current locations with the values of these parameters determined from the skin electrocardiograms in an equivalent lead, e.g., lead II. Thresholds T1 through T6 are empirical values subject to adaptive adjustments relative to each patient. Each of the criteria or a combination of criteria shown in FIG. **12** can be used.

Other decision algorithms can also be used, in particular related to the level of electrical energy as calculated from the ECG spectrum. In the case of placing endovascular devices, one criterion may be that, at the location corresponding to the lower third of the SVC, the average electrical energy calculated from the endovascular ECG is twice as high as the average electrical energy calculated from the endovascular ECG at skin level or from a skin ECG in a corresponding lead, e.g., lead II.

Method for Placement of Central Venous Catheters

A method of placing a central venous catheter (CVC) is presented below.

1. Estimate or measure the required length of the vascular access device (CVC) for the given patient.

2. If using saline and adaptor (**200**), go to step 11; if not, proceed as follows. Insert a guidewire into the CVC and flush align the guidewire tip and the catheter tip. Measure the length of the guidewire outside the CVC. This measurement is necessary in order to be able to realign the tip of the catheter and of the guidewire after inserting the guidewire in the vasculature. After taking the measurement, for example with sterile measuring tape or with surgical thread, remove the guidewire from the CVC.

3. Gain vascular access and insert the guidewire for the estimated required length.

4. Insert the CVC over the wire such as to leave outside the CVC the length of the guidewire measured at step 1. Thus the CVC inserted over the wire and the guidewire tips are flush-aligned.

5. Connect a sterile electrical adaptor to the guidewire per the instructions for use.

6. Connect the other end of the sterile electrical adapter to the ECG cable of the electrography system.

7. Check that the display of the electrography system indicates desired position of the catheter tip per the instructions for use of the electrography system: in the lower third of the SVC, at the caval atrial junction or in the right atrium. Typically, the location of the tip of the catheter will be identifiable through the specific shape of the P-wave and of the P-wave relative to the R-wave of the electrogram and/or by the energy levels and thresholds.

8. Adjust the position of the guidewire and CVC by pulling and/or pushing them together as not to change the flush alignment until the ECG waveform on the screen indicates that the desired position has been reached. Correlate the actual inserted length with the estimated length.

9. After the position has been reached, disconnect the electrical adaptor and remove the guidewire.

10. Secure the CVC in location.

11. Continue here if saline and adaptor (**200**) are used.

12. Gain vascular access and introduce the CVC over the guidewire as currently specified by the existing protocols.

13. Remove the guidewire

14. Attach the sterile adaptor (**200**) to the CVC.

15. Attach the electrical connection (**234**) of the adaptor (**200**) to the ECG cable of the electrography system.

16. Fill a syringe with saline and connect it to the other end of the adaptor (**200**). Flush the catheter lumen with saline as to create a conductive saline column all way through the catheter tip.

17. Check that the ECG waveform shown on the display of the electrography system indicates desired position of the catheter tip per the instructions for use of the electrography system: in the lower third of the SVC, at the caval atrial junction or in the right atrium. Typically, the location of the tip of the catheter will be identifiable through the specific shape of the P-wave and of the P-wave relative to the R-wave of the electrogram and/or by energy levels and thresholds.

18. Adjust the position of the CVC by pulling and/or pushing until the ECG waveform on the screen indicates that the desired position has been reached. Correlate the actual length with the estimated length.

19. After the desired position has been reached remove the syringe and the adaptor (**200**).

20. Secure the catheter.

Method for Placement of Implantable Ports

A method of placing the catheter piece of an implantable port is similar to the method for placing a CVC. The adaptor (**200**) should be connected to the catheter of the implantable port, and the syringe with saline must be connected to the other end of the universal adaptor. A different electrical adaptor should be connected to a syringe needle placed in the catheter of the implantable port. After reaching the desired position, the catheter should be connected to the implantable port.

Method for Placement of Peripherally Inserted Central Catheters Open and Closed Ended

Both open-ended and closed-ended peripherally inserted central catheters (PICC) can be placed as described herein, and the method of PICC placement is similar to the one of placing CVCs. The inventive steering mechanism described herein can be used to bend the tip of the PICC in case the catheter fails to advance in the desired direction.

Method for Placement of Hemodialysis Catheters

A method for placing hemodialysis catheters is similar to the method introduced herein for placing CVCs. The inventive steering mechanism described herein can be used to bend the tip of the hemodialysis catheter in case the catheter fails to advance in the desired direction. Two different guidewires with adaptors (**220**) can be used for each of the lumens of the hemodialysis catheter as to guide placement of one lumen into the right atrium and of the other lumen at the caval atrial junction using the electrography system. Each of the lumens of the hemodialysis catheter can be placed independently in sequence or at the same time by connecting the adaptors (**220**) of each of the lumens with different electrodes of the ECG cable of the electrograph system.

Method for Placing Central Venous Access Devices in Patients with Arrhythmias

Traditionally, patients with arrhythmias have been excluded from procedures of guiding central venous lines placement using the endovascular ECG method because of

the lack of visible changes in the shape of the P-wave. The energy criteria for the P-wave analysis described herein can be used to guide the placement of central venous access devices in patients with arrhythmias. In arrhythmia patients, the electrical signals generated by the sino-atrial node have a certain degree of randomness, such that they are not synchronized in order to produce a consistent P-wave. Nevertheless, as previous studies have shown, the electrical activity of the sino-atrial node exists and generates electrical energy of intensities typical to the proximity of the sino-atrial node. In one embodiment, the algorithm uses the energy as measured from the endovascular electrogram in order to map certain location in the vasculature. As such, this algorithm can be used to guide placement in patients with arrhythmias when only the electrical energy is indicative of location but not the shape of the P-wave.

Method for Monitoring Tip Location and Certain Aspects of the Electrical Activity of the Heart

Certain aspects of the electrical activity of the heart can be monitored continuously or intermittently using the devices introduced herein. Either an electrical adaptor or adaptor (200) connected to the electrography system can be used for monitoring. The electrical adaptor can be connected to any stylet or other conductive member introduced in any venous access device or in any arterial device. Adapter (200) can also be connected to any venous or arterial line as long as the infusion of a conductive solution, e.g., saline is possible. Adapter (200) can also be used when electrically conductive fluids are inserted in the body using an infusion pump. Monitoring the tip location and/or certain aspects of the electrical activity of the heart can be performed in a number of clinical situations.

1. Adaptor (200) can be attached to a number of central venous devices post insertion, e.g., at bedside and/or in home care situations: PICCs, CVC, hemodialysis catheters. By connecting the adaptor to such a catheter and to an electrography system according to an embodiment of the present invention and by injecting saline into the catheter, the location of the tip of the catheter can be confirmed and/or certain electrical activity of the heart can be monitored during the time the adapter is connected by using methods similar to those introduced above in embodiments of the present invention.

2. Adaptor (200) can be connected to an arterial line between the arterial line and the other devices connected to the arterial line. The blood present in the arterial line and in the universal adaptor ensures the electrical connection between the blood and the electrography system. Thus the electrical activity of the heart can be continuously monitored. This is particularly important in the case of monitoring the preload changes which translate in changes of the electrical energy of the heart during the S-T segment of the ECG waveform.

3. Monitoring of the tip location and of the electrical activity of the heart can also be achieved by using the electrography system and connecting the adaptor (200) between a central venous line and a pressure measuring system while performing central venous pressure measurements.

4. In the case of an implanted port, a needle can be inserted into the port chamber and the catheter can be flushed with saline using a syringe filled with saline. An electrical adaptor can be attached to the needle and to the electrography system. The detected electrogram signal will contain information from the skin level where the needle is in contact with the skin and from the tip of the catheter through the injected saline column. Since the impedance of

the path to the catheter tip is lower than the one to the skin, the detected signal contains both components, i.e., at the skin level and at the tip of the catheter. By subtracting the skin level signal, the signal at the tip of the catheter can be estimated and thus the tip position and certain electrical activity of the heart according to the algorithms described in embodiments of the present invention.

FIG. 13 illustrates the cardiac conduction system of the heart, while FIG. 14 illustrates electrical signal propagation in the conduction system of the heart.

These figures illustrate the conductive mechanism of the heart, which explains why the electrical energy distribution within the heart as measured is indicative of specific locations within the heart. Accordingly, local electrical signals, behaviors and energy concentrations can be measured and locations within the heart and blood vessel can be determined more accurately; local heart conditions can also be described more accurately.

The conduction system of the heart begins with the heart's dominant pacemaker, the sino-atrial node (1310). The intrinsic rate of the SA node is 60 to 100 beats/minute. When an impulse leaves the SA node, it travels through the atria along the Bachmann's bundle (1350) and the inter-nodal pathways, on its way to the atro-ventricular (AV) node (1320) and ventricles. After the impulse passes through the AV node, it travels to the ventricles, first down to the bundle of His (1330) then along the bundle branches and finally down to the Purkinje fibers (1340). Pacemaker cells in the junctional tissue and Purkinje fibers on the ventricles normally remain dormant because they receive impulses from the SA node. They initiate an impulse only they do not receive one from the SA node. The intrinsic rate of the AV junction is 40 to 60 beats/minute, the intrinsic rate of the ventricles 20 to 40 beats/minute. The different propagation speeds of the electrical impulses are shown in FIG. 14. From the SA node (1410) the impulses propagate through the atrial muscle (1420) and through the ventricular muscle (1460) at app. 0.5 ms, through the bundle branches (1440) and (1450) at app. 2 m/sec, through the Purkinje fibers (1470) at app 4 m/s and through the AV node (1430) at app. 0.05 m/s.

The electrical signals and the electrical energy distribution are advantageously used to identify the proximity of the sino-atrial node and right atrial electrical activity even in the cases of arrhythmia, i.e., in the absence of a coherent P-wave measured by standard skin electrocardiogram. While in some cases of arrhythmia random electrical signal generated in the right atrium is not coherent enough to propagate through the body to the skin, the electrical energy is still present in the right atrium and can be detected by local endovascular measurements as a non-coherent P-wave, i.e., as significant electrical activity in the P-segment of the ECG waveform. Energy measurements are also less sensitive to some local abnormalities in impulse conduction: altered automaticity (arrhythmias), retrograde conduction of impulses, reentry abnormalities.

The electrical signals and the electrical energy distribution are also advantageously used to quantify heart functionality, e.g., preload which is related to the depolarization and extension of the heart muscle.

The electrical signals and the electrical energy distribution are also advantageously used to guide guidewires and guiding catheters through the aorta into the left heart. This method is useful in simplifying the access to the left atrium and to the coronary arteries and in reducing the amount of contrast and radiation needed to guide endovascular devices to those locations. In a different application, the inventive apparatus can also be used to guide catheters, e.g. Swan-

Ganz through the right ventricle into the pulmonary artery. Other endovascular devices can be guided and be used to measure endovascular electrical activity in other locations of the cardiovascular system which are identifiable by the cardiograms measured with the new apparatus introduced in 5 embodiments of the present invention.

FIG. 15 illustrates electrical activity in the cardiovascular system due to neuronal control system. Several paths of conduction are related to the mechanism of control of heart (1530) and blood vessel (1520) activity: receptors (1510), e.g., pressure receptors transmit information related to the state of the blood vessels and to the state of the heart to the nervous system through the Medullary centers (1500). The hypothalamus (1540) and the higher centers (1550) are involved in processing and reacting to the information 15 received from the sensors/receptors. In turn they send impulses (1560) back to blood vessels and the heart. By measuring electrical activity related to the control system, information regarding heart conditions can be obtained which could not have been obtained previously.

FIG. 18A illustrates the Einthoven ECG triangle and the naming convention for the ECG leads as they are used herein in connection with various embodiments. In order to obtain ECG signals from the patient, typically, one electrode is placed on the right arm (RA), one on the left arm (LA) and one is used as reference on the left leg (LL). The direction 25 in which the P-wave changes most is shown by the arrow (2200). Therefore, when using endovascular ECG for catheter navigation and tip location, the electrode corresponding to the right arm (RA) is operably connected to the proximal end of the vascular access device (110) (FIG. 1A), such as a catheter, in one embodiment. In this way, an ECG waveform detected with respect to the distal end of the catheter, e.g., via an electrode disposed on the catheter, can be considered as detected by Lead II of the Einthoven triangle. Thus, when the catheter is advanced through the vasculature, Lead II will show most significant changes of the P-wave and therefore is best suited to detect the proximity of the sino-atrial node. The sino-atrial node is located at the caval-atrial junction and is responsible for generating the P-wave (indicative of the right-atrial electrical activity). The waveform corresponding to Lead III in the Einthoven triangle remains relatively unchanged as the catheter navigates through the vasculature in one embodiment if the RA electrode is operably connected to the catheter. Therefore, Lead III is used in an embodiment of the present invention as a reference lead which serves multiple purposes, as described herein. In one embodiment, the apparatus introduced herein displays simultaneously ECG signal-based waveforms for Lead II, also referred to herein as the endovascular ECG lead, (for catheter navigation and tip positioning) and for Lead III, also referred to herein as the skin ECG lead, (as a reference waveform).

Reference is again made to FIG. 5, which illustrates the mapping of different endovascular ECG waveforms to the corresponding locations in the vasculature and in the heart, according to one embodiment. In detail, Location A corresponds to the upper superior vena cava (SVC), Location B corresponds to the lower $\frac{1}{3}$ of the SVC, Location C corresponds to the caval-atrial junction, Location D corresponds to the right atrium, and Location E corresponds to the lower atrium and/or to the inferior vena cava.

FIG. 18B illustrates the endovascular (Lead II) ECG waveform (2215) obtained with a device disclosed herein, such as an ECG sensor-containing catheter, as measured at 65 Location A in FIG. 5. The skin ECG waveform (2210) represents a skin reference ECG lead equivalent with Lead

III. A reference P-R complex is illustrated by (2280). The typical P-R complex at Location A is illustrated by (2250). While the P-wave changes dramatically on Lead II according to movement of the catheter and its ECG sensor within the vasculature, as seen in the P-R complex (2250) for instance, the P-wave remains substantially constant on Lead III used as a reference (2280).

In one embodiment, waveforms from two ECG leads (e.g., Lead II and III in FIG. 18B) are simultaneously depicted on a display of an apparatus, such as a catheter placement system for example, as illustrated in FIGS. 18B-18F. In another embodiment, three leads (Lead I, II, and III of FIG. 18A) may be displayed at the same time as shown in FIG. 20F.

By using the method, apparatus, and ECG electrode configuration introduced herein, it is possible in one embodiment to monitor the patient condition, e.g., the patient's heart rate using the skin reference lead (Lead III) while at the same time guiding the catheter placement using endovascular Lead II.

FIG. 18C illustrates the endovascular ECG waveform (2220) obtained with the device disclosed herein as measured at Location B in FIG. 5. The skin ECG waveform (2210) represents a skin reference lead equivalent with Lead III. A reference P-R complex is illustrated by (2280). The typical P-R complex at Location B is illustrated by (2255). As before, while the P-wave changes dramatically in the P-R complex (2250) on Lead II corresponding to the tip of the catheter, the P-wave remains quite constant on Lead III used as a reference (2280).

FIG. 18D illustrates the endovascular ECG waveform (2225) obtained with the device disclosed in an embodiment of the present invention at Location C in FIG. 5. The ECG waveform (2210) represents a skin reference lead equivalent with Lead III. A reference P-R complex is illustrated by (2280). The typical P-R complex at Location C is illustrated by (2260). While the P-wave changes dramatically in the P-R complex (2260) on Lead II corresponding to the tip of the catheter, the P-wave remains quite constant on Lead III used as a reference (2280).

FIG. 18E illustrates the endovascular ECG waveform (2230) obtained with the device disclosed in an embodiment of the present invention at Location D in FIG. 5. The ECG waveform (2210) represents a skin reference lead equivalent with Lead III. A reference P-R complex is illustrated by (2280). The typical P-R complex at Location D is illustrated by (2265). While the P-wave changes dramatically in the P-R complex (2265) on Lead II corresponding to the tip of the catheter, the P-wave remains quite constant on Lead III used as a reference (2280).

FIG. 18F illustrates the endovascular ECG waveform (2240) obtained with the device disclosed in an embodiment of the present invention at Location E in FIG. 5. The ECG waveform (2210) represents a skin reference lead equivalent with Lead III. A reference P-R complex is illustrated by (2280). The typical P-R complex at Location E is illustrated by (2270). While the P-wave changes dramatically in the P-R complex (2270) on Lead II corresponding to the tip of the catheter, the P-wave remains quite constant on Lead III used as a reference (2280).

FIG. 19A illustrates the ability of the apparatus introduced herein, e.g., a catheter placement system, to show several display windows at the same time on the screen thereof. One, two, or more display windows can be included. Each of the display windows (3310 and 3320) can display one to three ECG waveforms (leads I, II, and III) in any combination, in real-time acquisition, in playback, or frozen modes.

In one embodiment, one display window (3310) is used to show real-time ECG waveforms (catheter guiding, or endovascular, lead II and skin reference lead III) and another display window (320) is used to show frozen ECG waveforms (catheter guiding lead II and skin reference lead III). Thus, the user can compare the changes in the catheter guiding lead and in particular in the P-R complex at two different catheter tip locations: at the tip location frozen in display window (2320) and at the current (real-time) tip location displayed in window (2310).

The above multi-window comparison enables the use of the following catheter placement method, according to one embodiment: first advance the catheter in the atrium until the P-wave reaches its maximum amplitude as seen in window (2320) (FIG. 19B) and then pull back the catheter to a location where the P-wave is half the size of its maximum amplitude. Such a location where the amplitude of the P-wave is half the size of its maximum amplitude is indicative of the lower third of the superior vena cava (Location B in FIG. 5).

FIG. 20A illustrates how the skin reference lead can be used to analyze the P-wave segment of the catheter guiding lead (Lead II), according to one embodiment. The P-wave segment, in which is found the P-wave itself, is characterized by the fact that it immediately precedes the QRS complex of the same heart beat. The P-wave segment of a heart beat also follows the T-wave of the previous beat. In order to detect the P-wave segment, an algorithm can be applied including detection of the R-peak of the QRS complex. The algorithm in one embodiment includes the following steps:

Detect R-peak.

Compute R-R interval.

Assume that a certain percentage of the R-R interval prior to the R-peak is the interval in which the P-wave occurs. This interval where the P-wave occurs is defined as the P-wave segment.

Detect the P-peak in the P-wave segment, its amplitude and polarity.

Apply processing, analysis and decision making algorithms as illustrated in FIGS. 11 and 12.

In one embodiment, in order to apply the algorithm described above, the R-peak and the R-R interval can be detected on endovascular Lead II, i.e., on the same ECG lead which is used for guidance. In another embodiment, the R-peak and the R-R interval can be detected using Lead III (the skin reference lead). In particular, the R-peak detection on Lead III (2410) in FIG. 20A can be used to trigger the analysis of any segment of the ECG waveform on Lead II including the analysis of the P-wave segment (2420) in FIG. 20A. It is also possible, if the signal quality of Lead II allows, to use the R-peak (2430) detected on lead II itself to trigger processing of the Lead II waveform. In other embodiments, other leads can be used to implement triggering on a different lead than the one used for catheter navigation and tip positioning. For example, Lead I can optionally be used for catheter navigation and tip positioning. The apparatus according to one embodiment allows also the use of Lead I for catheter navigation and tip positioning, though Lead II is suitable in many clinical settings. Note that in one embodiment the above triggering can occur for peaks on a waveform detected by the same lead. Also, a peak detected on Lead II can be used to trigger analysis of Lead I, in one embodiment. Thus, these and other variations are contemplated.

Triggering analysis on one ECG lead that is different than the ECG lead used for catheter navigation and positioning as

introduced herein is useful in many practical situations regardless of which ECG lead is used for triggering the analysis and which ECG lead is used for catheter navigation and positioning. As will be seen in FIGS. 20B-20E and especially in FIG. 20E, triggering on a stable, noiseless lead, e.g., Lead III improves the ability to process different segments of other leads, e.g., endovascular Lead II used for catheter navigation and positioning in cases where the Lead II ECG signal includes a greater than desired amount of signal noise. Noisy Lead II ECG signals appear quite frequently in practical settings because of the manual handling of the Lead II connection by the user. Other situations can benefit from the trigger concept introduced herein, as will be seen below.

FIG. 20B illustrates how the R-peak detected on reference skin Lead III (2410) and the corresponding R-R interval trigger the analysis of the PQRST segment (2430) on the navigation Lead II. As described herein, the P-wave segment and the QRS complex of the ECG Lead II can be analyzed separately or in relationship to each other in order to predict the location of the catheter tip in the vasculature. In the case shown in FIG. 20B, the P-wave has a large positive amplitude which is equal to the R-amplitude and is also bipolar (has a negative first segment). In such a case, the detection of the R-peak on the Lead II itself is very difficult if not impossible through the use of algorithms. Triggering the ECG waveform analysis of Lead II (2430) based on detection of the R-peak detected on the reference Lead III (2410), as introduced herein, allows for detection and processing of the changes of the P-wave segment characteristics of the catheter tip location. Such algorithmic ECG waveform analysis of Lead II would otherwise be difficult in the case shown in FIG. 20B because of the difficulty of clearly detecting the R-peak on this lead.

FIG. 20C illustrates how triggering on the R-peak of one lead, for example the R-peak of Lead III (2410) can be used to trigger the analysis of the P-wave segment on catheter navigation Lead II (2440) in the case of a patient with arrhythmias. Typically, the P-wave segment is not present in the skin ECG lead in patients with arrhythmias, as seen in FIGS. 20C and 20D. However, the catheter navigation and tip positioning lead, e.g., Lead II, can detect a relatively higher level of electrical activity in the P-wave segment as the catheter approaches the sino-atrial node and the caval-atrial junction. The level of electrical activity (energy) in the P-wave segment increases further as the catheter tip passes the sino-atrial node and enters the right atrium. Since the highest level of this increased electrical activity on the P-wave segment of navigation Lead II cannot be predicted, e.g., the P-wave amplitude could be higher than that of the R-wave on the Lead II, triggering the analysis of the said P-wave segment on the R-peak of a skin ECG lead provides a suitable solution to P-wave detection and subsequent catheter tip location and positioning.

FIG. 20D illustrates the lack of P-wave in the case of an arrhythmia patient on both ECG leads II and III. In FIG. 20D, lead II is connected to a skin electrode on the right arm of the patient and lead III to a skin electrode on the left arm of the patient. The R-peak on lead III (2410) is depicted in this figure and the corresponding segment showing the absence of a discernible P-wave on lead II is shown as (2450).

FIG. 20E illustrates the situation in which the catheter navigation lead, e.g., Lead II, is noisy or unstable and the detection of the R-peak and of the corresponding P-wave is thus difficult. In this case, as before, detecting the R-peak (2410) on a stable reference lead, e.g., the skin Lead III,

preserves the ability via the above-described triggering, to find and analyze the P-wave segment (2460) on the noisier catheter navigation lead.

FIG. 20F illustrates another embodiment, wherein two leads (in this example Leads I and II—see FIG. 18A) are used to detect simultaneous, corresponding ECG waveforms (2470) and (2475) and triangulate, together with an additional, simultaneous ECG waveform (2480) of the reference lead (Lead III), the location of the catheter tip. In particular, a substantially accurate location of the catheter tip can be determined by looking at Leads I and II at the same time and use their correlation (or lack thereof) to reduce noise and more accurately determine the changes of the P-segment, of the QRS segment, and the relative changes between the P-wave and the QRS complex.

FIGS. 21A and 21B illustrate details regarding an algorithm to use the P-wave segment and/or its relationship with the QRS complex for catheter navigation and tip location in the case of arrhythmia, according to one embodiment.

Specifically, FIG. 21A illustrates the ECG waveforms for two skin ECG leads (using skin electrodes). In FIG. 21A, Lead III with its corresponding R-peak (2510) is detected using the skin left arm electrode and Lead II showing the lack of the P-wave (2520) is detected using the skin right arm electrode, both being compared with the skin left leg electrode, in one embodiment. Previously, patients showing these typical arrhythmia ECG waveforms were not considered as candidates for using the ECG-based method for catheter navigation and tip location. It was believed that, because the P-wave is not present at the skin level, the ECG method cannot be used to determine catheter tip location at the caval-atrial junction. FIG. 21A thus illustrates a situation where the R-peak of the skin reference lead (2510) can be used to compute the characteristics and the energy of the P-segment (P-wave) on the navigation lead at locations where the P-wave is not present.

In greater detail, FIG. 21B illustrates ECG waveforms as obtained with the apparatus described in connection with FIGS. 20A-20E and show that, with the apparatus and method described herein, even arrhythmia patients can be treated using ECG-based catheter navigation and tip location. Due to the processing algorithms described in FIGS. 11 and 12, the ECG signal obtained from the tip of the catheter on Lead II is more accurate and less noisy when compared to prior art. Thus, changes in the P-wave segment (2530) become visible when the catheter tip is in the proximity of the sino-atrial node. They correspond, as justified by physiology, to a random electrical activity of the right atrium. This random electrical activity and its changes can be detected with the apparatus introduced herein as illustrated by the P-wave segment (2530). This random electrical activity typically cancels out once reaching the skin and the Lead III and thus is difficult or impossible to detect by prior art ECG methods.

Sometimes the above random electrical activity of the right atrium is also very weak and an apparatus such as the one introduced herein is needed to detect it even at the tip of the catheter. By observing and/or analyzing the changes of the P-wave segment on the catheter navigation lead, the tip location of the catheter can be mapped, for example, to locations in the superior vena cava (weak, low energy or no P-wave), to locations at the caval atrial junction and to locations in the right atrium. FIG. 21B illustrates how the R-peak on the reference lead (e.g., skin Lead III) can trigger the analysis of the corresponding P-wave (P-segment) on the navigation lead (e.g., endovascular Lead II) at locations where a P-wave segment (2530) is present.

In addition to those described in FIGS. 11 and 12, it is appreciated that other decision algorithms can be used, such as those related to the level of electrical energy as calculated from the electrogram spectrum, in placing a catheter or other endovascular devices. For instance, one criterion specifies that at the location corresponding to the lower third of the SVC, the average electrical energy calculated from the endovascular electrogram is twice as high as the average electrical energy calculated from the endovascular electrogram at skin level, e.g., from a skin electrocardiogram in a corresponding lead, e.g., Lead III.

In addition to the algorithms disclosed above in connection with FIGS. 11 and 12, the concept of directional energy and of decision making based thereon are introduced herein.

As seen, for example, in FIGS. 18B at (2250) and 18C at (2255), the P-wave is uni-polar, i.e., has a single polarity, the polarity being positive. In comparison, FIGS. 18D at (2260) and 18E at (2265) illustrate a bi-polar P-wave, i.e., a P-wave which has both a negative and a positive component. FIG. 18F illustrates a P-wave segment at (2270) with a uni-polar P-wave segment but of polarity reversed compared to that of the P-wave segment shown in FIGS. 18B and 18C.

The above change of polarity in the P-wave segment is due to the location of the catheter tip relative to the sino-atrial node and of the locations of the skin electrodes according to the Einthoven triangle (FIG. 18A). In the cases illustrated herein, as the catheter navigates from the superior vena cava through the caval-atrial junction, through the right atrium and into the inferior vena cava, the polarity of the P-wave segment changes correspondingly.

According to one embodiment and in light of the above, catheter tip location can be determined by the following: a positive energy value and a negative energy value are determined for a detected P-wave by the apparatus described herein, such as a catheter placement system. The positive P-wave energy value is determined according to the energy computation algorithms described herein, but only for positive values of the P-wave (i.e., values above the ECG baseline). Correspondingly, the negative P-wave energy value is determined according to the energy computation algorithms described herein, but only for negative values of the P-wave (i.e., values below the ECG baseline). These energy values (positive and negative) determined according to the present embodiment are also referred to herein as “directional energy” values because they are related to the direction and location of the catheter tip at which point the P-wave is being detected via an appropriate sensor in operable connection with a corresponding ECG lead, such as the endovascular Lead II discussed above.

The P-wave directional energy described above can be used to guide navigation of a catheter and for locating a tip thereof, according to one embodiment. Particularly, in one embodiment a standard Einthoven electrode configuration, with the right arm electrode detecting endovascular ECG signals at the catheter tip (as described above in connection with FIGS. 20A-20E) is considered. Note that other electrode configurations are also possible. If the P-wave energy is substantially entirely positive, the catheter tip is considered to be located above the sinoatrial node, for example in the superior vena cava. If the P-wave includes positive energy and a relatively small amount of negative energy, but the positive energy is smaller relative to the R-wave energy, such as is seen at (2260) in FIG. 18D, the catheter tip may be located at the caval atrial junction. If the P-wave segment includes a large amount of negative energy relative to its positive energy, and the positive energy is comparable to that of the R-wave energy, such as is seen in at (2265) in FIG.

18E, the catheter tip may be in the right atrium. If the P-wave includes substantially entirely negative energy, as seen at (2270) in FIG. 18F, the catheter tip is approaching the inferior vena cava or is in the inferior vena cava. In this way, the directional energy introduced herein is used by the present method described herein for catheter navigation and tip location.

FIGS. 22A-22D and 23A-23B illustrate various details regarding a connector according to example embodiments, which allow for the use of the apparatus and method described herein by a single operator in the sterile field.

In particular, FIG. 22A shows a connecting object (2915) including magnetic attraction properties and a surface including electrically conductive properties. The connecting object (2915) electrically connects to two connectors (2910) and (2920). The connector (2910) is connected to one end of a sterile device/adaptor (2905). The other end of the sterile device (2905) can be connected to a sterile guidewire or stylet or to a sterile saline adaptor as described further above. The connector (2920) can be attached to or be itself one end of an ECG cable connected to the apparatus illustrated herein in FIG. 1A.

The surface of the connecting object (2915) can be implemented in several ways. In one embodiment, a magnet is built into an enclosure with an electrical conductive surface. The magnet attracts the electrical connectors (2910) and (2920) to the metallic surface and locks them on the surface, thus establishing electrical contact between connector (2910) and the electrically conductive surface of the connecting object (2915) and another electrical contact between the electrically conductive surface of the connecting object (2915) and the other electrical contact (2920).

The connecting object 2915 illustrates one type of connector that can be used with the methods described herein by a single operator in the sterile field. Accordingly, in one embodiment, the object (2915) is placed prior to the commencement of a catheter placement procedure in the non-sterile field such that it can be reached by the single sterile operator during the procedure. Then, the as-yet non-sterile operator connects one end of the non-sterile connector (2920) to an ECG cable and “drops” the connector end shown in FIG. 22A onto the surface of the connecting object 2915. Because of the magnet incorporated in the object (2915), the connector (2920) is attracted to the electrically conductive surface of the connecting object and adheres to the surface thereof. The end of the ECG cable to which the connector (2920) is attached or included can be an ECG lead itself, thus simplifying the workflow.

During the procedure, the single operator is sterile. The operators opens the sterile package in which the connector (adaptor) (2910, 2905) is packaged, holds the sterile connector end (2915) with a sterile gloved hand and drops the sterile connector onto the electrically conductive surface of the connecting object (2915). Similarly to connector (2920), the connector (2910) is magnetically attracted to the connecting object (915) by the built-in magnet, which secures the connector (2910) on the electrically conductive surface of the connecting object. Using this method, an electrical connection can be established between a sterile electrical connector (2910) and a non-sterile connector (2920) without compromising the sterile field. Again, this method can be used by a single operator and enables the single sterile operator use of the apparatus described herein.

FIG. 22B illustrates another embodiment of the connector, wherein the connecting object (2930) is directly connected to a wire or is an integral part of an ECG cable (2935). This embodiment simplifies the method described

above in connection with FIG. 22A, as only the sterile connector (2925) connected to the sterile adaptor (2905) must be dropped on to the electrically conductive surface (2930) of the connecting object (2930) during the sterile procedure.

FIG. 22C illustrates another embodiment of the connecting object, wherein a connector (2940) of the sterile adaptor (2905) is similar to the adapter (2905) and connector (2910) described above in connection with FIG. 22A. During a catheter placement procedure, the sterile operator drops the sterile connector (2940) into a connecting object, or mating piece (2945). The mating piece (2945) includes a cup that receives therein the connector (2940). A magnet is built into the cup, which attracts the connector (2940) into the cup to secure it therein. At the same time, the cup ensures electrical connectivity. The mating piece (2945) can be an integral part of an ECG cable (2950) (e.g., one end of an ECG lead), one end of a wire for connection to an ECG cable, or some other suitable configuration. The method for using the mating piece 2945 is similar to that described in connection with FIG. 22B, with a difference being that the cup (2945) has the ability to suck in the connector (2940) for a relatively secure male/female-type connection. As is the case with the embodiments described in connection with FIGS. 22A, 22B, and 22D, the shapes and materials used for the connecting objects can vary while still ensuring proper electrical contact for the component interconnected therewith.

FIG. 22D illustrates a connecting object configuration similar to that described in connection with FIG. 22C, except that a cup (2960), which contains a magnet for operably connecting with a connector (2955), includes on an opposite end a connector (2965) to which an ECG cable clip can be attached. As such, during a placement procedure a non-sterile operator can connect the connector (2965) to a commercially available ECG cable by using the clip provided with the ECG cable. Later, during the sterile procedure, the sterile operator drops the sterile connector (2955) into the cup (2960), similar to the method described in connection with FIG. 22C.

FIG. 23A illustrates details of a steerable sterile adaptor (3010) according to one embodiment, including a reinforced sterile connector piece (3020) of rigid plastic, for instance. Instead of dropping the sterile connector piece (3020) into a mating piece (3030) as in FIGS. 22C and 22D, the sterile operator can use the rigid connector piece (3020) of the sterile adaptor (3010) to steer, e.g., push, rotate, etc., it into the mating piece. In one embodiment, the mating piece (3030) includes a built-in magnet to attract the connector piece 3020. In another embodiment, the mating piece (3030) includes no magnet, but is of an appropriate size and shape for the connector piece (3020) to fit therein so as to establish suitable electrical contact therebetween.

FIG. 23B illustrates a steerable connector piece (3040) according to one embodiment, which can be pushed into and operably connect with a simple mating piece (3050) without the need of a magnet. In addition to what has been shown and described, other shapes are possible for the connector (3040) and its mating piece (3050), e.g. rails or screws.

It is appreciated that any suitable combination of the connector embodiments discussed above can be used. For example, the steerable connector of FIG. 23B can include a mating piece like that shown in FIG. 22D.

FIGS. 24A-24F illustrate various details of catheter navigation according to one embodiment. As shown, each of these figures includes two display windows: a first window showing ECG waveforms, and a second window showing a representation, or icon, of a heart and an additional location

icon indicating the point of measurement of the ECG signal to which the ECG waveforms in the first window correspond. The mapping between ECG waveforms and the location icon is performed in one embodiment using the algorithms and methods described above. The two display windows can be used independently or together. In one embodiment, the two display windows are shown simultaneously on the graphical user interface (FIG. 1A) in order to allow the operator to correlate the observed ECG waveform (s) with catheter tip location. In another embodiment, only the heart and location icon window is shown in order to simplify the user interface.

The location icon can include any one or more of several possible configurations, including an arrow to show advancement in a certain direction, a dot, a cross, a star, etc., to show an identifiable location. Each of these icons can include different colors to emphasize location relevance. In another embodiment, different sounds can be associated to each of the identifiable tip locations. Sounds and icons identifying tip locations can be used together or independently to help the user navigate the catheter and locate the tip within the patient vasculature.

In one embodiment a simplified user interface is employed, wherein only the heart icon and the corresponding location icon(s) are displayed. In this instance, the ECG waveforms and the computation behind the location mapping are not visible to the user. Thus, the apparatus described herein can be employed for navigation and tip location without requiring user interpretation of the ECG waveforms. The simplified user interface with only the heart and catheter tip location icons can be used as shown in the embodiment illustrated in FIG. 25B, for instance.

In greater detail, FIG. 24A illustrates ECG waveforms corresponding to catheter tip locations outside the thoracic cavity in the upper body: a skin reference ECG Lead III (3110) and an endovascular catheter navigation ECG Lead II (3115). In the icon display window, a heart icon (3125) is displayed and a location icon (3120) shows that the catheter is moving towards the thoracic cavity. In another embodiment, the arrow-shaped location icon (3120) can be replaced with a cross, a dot, or any other suitable icon showing location above and outside the superior vena cava.

The arrow-shaped location icon (3120) is displayed by the apparatus according to one embodiment only if the algorithms detect changes in the navigation ECG Lead II that support the fact that the catheter tip is moving towards the heart, e.g., a steady increase in the electrical energy and a P-wave with positive directional energy, indicating that the tip is approaching the sino-atrial node. If the algorithms do not detect a steady increase in the electrical energy of the endovascular ECG signal as the catheter advances through the vasculature, only a dot, star, cross or other suitable location icon is displayed at a location above and outside the superior vena cava. Sounds associated with each of these locations and situations can be played in addition to or instead of the graphical icons.

FIG. 24B illustrates the ECG waveforms corresponding to the reference lead (3110) and catheter navigation lead (3115) at a location corresponding to the upper superior vena cava. The icon display window shows the heart icon (3125) and a dot-shaped location icon (3130) indicating the upper superior vena cava on the heart icon. This location is determined by the apparatus, as described further above, based on the ECG waveforms (3110) and (3115). As in FIG. 24A, any suitable icon shape and color can be used, and/or a sound or tune can be played when the tip of the catheter reaches the location indicated by the detected ECG waveforms.

FIG. 24C illustrates the ECG waveforms corresponding to the reference lead (3110) and catheter navigation lead (3115) at a location corresponding to the lower third of the superior vena cava. The icon display window shows the heart icon (3125) and a dot-shaped location icon (3140) indicating the lower third of superior vena cava on the heart icon. This location is computed by the apparatus, as described further above, based on the ECG waveforms (3110) and (3115). As in FIG. 24A, any suitable icon shape and color can be used and/or a sound or tune can be played when the tip of the catheter reaches the location as indicated by the detected ECG waveforms.

FIG. 24D illustrates the ECG waveforms corresponding to the reference lead (3110) and catheter navigation lead (3115) at a location corresponding to the caval-atrial junction. The icon display window shows the heart icon (3125) and a dot-shaped location icon (3150) indicating the caval-atrial junction on the heart icon. This location is computed by the apparatus, as described further above, based on the ECG waveforms (3110) and (3115). As in FIG. 24A, any suitable icon shape and color can be used and/or a sound or tune can be played when the tip of the catheter reaches this location as indicated by the detected ECG waveforms.

FIG. 24E illustrates the ECG waveforms corresponding to the reference lead (3110) and catheter navigation lead (3115) at a location corresponding to the right atrium. The icon display window shows the heart icon (3125) and a dot-shaped location icon (3160) indicating the right atrium on the heart icon. This location is computed by the apparatus, as described further above, based on the ECG waveforms (3110) and (3115). As in FIG. 24A, any suitable icon shape and color can be used and/or a sound or tune can be played when the tip of the catheter reaches this location as indicated by the detected ECG waveforms.

FIG. 24F illustrates ECG waveforms corresponding to catheter tip locations outside the thoracic cavity in the lower body: the skin reference ECG Lead III (3110) and the endovascular catheter navigation ECG Lead II (3115). In the icon display window, the heart icon is displayed (3125) and an arrow-shaped location icon (3170) showing that the catheter is moving away from the thoracic cavity, such as toward the inferior vena cava. In another embodiment, the arrow-shaped location icon (3170) can be replaced with a cross, a dot, or any other suitable icon showing location below the right atrium.

The arrow-shaped location icon (3170) is displayed by the apparatus in one embodiment only if the algorithms detect changes in the navigation ECG Lead II that support the fact that the catheter tip is moving away from the heart, e.g., a steady decrease in the electrical energy and a P-wave with negative directional energy, indicating that the tip is moving away from the sino-atrial node. If the algorithms do not detect a steady decrease in the electrical energy of the endovascular ECG signal as the catheter advances through the vasculature but detect a negative P-wave, only a dot, star, cross or any other location icon is displayed at a location below and outside the right atrium. The sounds associated with each of these locations and situations can be played in addition to or instead of the graphical icons.

FIG. 25A illustrates a display window on a graphical user interface of a mobile phone (3210), tablet PC, or other suitable handheld or portable device. In particular, the user interface of the mobile phone is shown displaying waveforms (3220) of two ECG leads: the reference lead and the catheter navigation lead. The mobile phone or other suitable device is in held in one embodiment in a horizontal position as to allow for a longer time (more heart cycles) of the ECG

waveform to be displayed. If the display device is in a real-time display mode, the display switches automatically to showing the ECG waveforms each time the device is turned horizontally. In another embodiment only one ECG lead is displayed at a time. In yet another embodiment, three or more leads can be displayed simultaneously. As described in an embodiment of the present invention, in another embodiment the screen of the display device can be split in real-time to depict a (current location) display window and a frozen (reference location) window to allow for easier assessment of ECG waveform changes. Two-way interaction between the apparatus shown in FIG. 1A and the mobile phone (3210) to enable the functionality shown and described in connection with FIGS. 25A-27B can be achieved in one embodiment via the wireless connectivity component 150, shown in FIG. 1A. It is appreciated that the mobile phone (3210) is equipped with corresponding wireless connectivity so as to enable communication therebetween, as appreciated by one skilled in the art.

FIG. 25B illustrates a simplified user interface (3230) displayed on the screen of a mobile phone (3210) or other suitable handheld/portable device based on the navigation interface described in FIGS. 24A-24F. When in real-time display mode and if the display device is positioned vertically, the device automatically displays the simplified user interface shown in FIG. 25B. When in real-time display mode, the device automatically switches back and forth between displaying ECG waveforms when the device is held horizontally, illustrated in FIG. 25A, and displaying the navigation user interface, illustrated in FIG. 25B when the device is held vertically.

FIG. 26 illustrates, in one embodiment, the zoom and scroll functions on the touch screen of a mobile phone (3310), tablet PC or similar device. The user can use two fingers (3320) to zoom in and out the ECG waveforms for better visualization. Scrolling through the ECG waveform recording can be also achieved using the fingers and the touch screen.

FIG. 27A illustrates the ability, in one embodiment to use a mobile phone (3410), tablet PC, or other suitable handheld/portable device to communicate the ECG waveforms and/or the simplified user interface and patient data to another computer or device. The communication interface is illustrated by (3420). Such transfer can be performed by the mobile phone (3410) via a Wi-Fi, cell phone, or other suitable network.

FIG. 27B illustrates the graphical user interface of a mobile phone (3410), tablet PC, or other suitable handheld/portable device, which allows for the display of patient data (3430), ECG waveforms (3440) or a simplified heart icon depending on the device orientation, and an interface (3450) browsing, control, and disposition of one or more patient records, including deleting, copying to memory, etc.

It is appreciated that the apparatus, algorithms, and methods described herein can be practiced in connection with a variety of environments and using a variety of components and systems. One example of an ECG monitoring system with which embodiments of the present invention can be practiced can be found in U.S. Patent Application Publication No. 2010/0036227, filed Sep. 10, 2009, and entitled "Apparatus and Display Methods Relating to Intravascular Placement of a Catheter." Another example of an ECG monitoring system can be found in U.S. Patent Application Publication No. 2009/0259124, filed Apr. 21, 2009, and entitled "Method of Locating the Tip of a Central Venous Catheter." Each of the foregoing applications is incorporated herein by reference in its entirety.

Non-limiting examples of ECG sensor stylets that can be used in connection with embodiments of the present invention can be found in U.S. Patent Application Publication No. 2010/0222664, filed Aug. 21, 2009, and entitled "Catheter Assembly Including ECG Sensor and Magnetic Assemblies," and U.S. Patent Application No. 2011/0015533, filed Sep. 29, 2010, and entitled "Stylets for use with Apparatus for Intravascular Placement of a Catheter," each of which is incorporated herein by reference in its entirety.

Reference is now generally made to FIGS. 28-39 in noting that additional methods can be employed to assist with the navigation and placement of a vascular access device, such as a catheter, within the vasculature of a patient using ECG signals, according to present embodiments, which are described below. As will be described, these embodiments disclose the automatic detection of regions and parameters of interest in the ECG signals, methods for analyzing the ECG signals to assist with determining in real time the intravascular location of the vascular access device, and an associated user interface.

Thus, in one aspect, an easy-to-use graphical interface is presented which is based on the automatic real-time detection of various parameters and regions of interest in signals related to endovascular ECG energy levels. For example, in the case of using endovascular ECG measurements for endovascular electrical energy computations, elements of the ECG signal can be automatically detected in real time, including the R-peak, the P-wave segment, the P-peak portions of an ECG waveform. These elements are highlighted in one embodiment using various graphical markers in order to allow an user to easily identify them, assess their characteristics, and follow their changes in real time.

In another aspect, the calculation of non-directional energy in an ECG signal complex is disclosed. In one embodiment, non-directional energy is calculated from an ECG signal corresponding to at least one heart beat of the patient, i.e., between two successive R-peaks bounding an ECG waveform complex. In one embodiment, the non-directional energy over this interval is calculated as: $E_{RR} = \text{Sum}_{RR} A^2 / \# \text{ of Samples}_{RR}$. In this context, the non-directional energy is calculated using all portions of the complex irrespective of the polarity of the portion, i.e., negative portions where the energy value is below the ECG signal baseline and positive portions where the energy value is above the ECG signal baseline.

The calculated non-directional energy values of one or more complexes of the ECG signal can be used to determine the location within the vasculature of the catheter or other vascular access device. Such a method can be readily implemented in an algorithm and automated for use by a suitable ECG monitoring and/or ECG-based tracking system. Further, the method can take into account changes in the electrical activity over the entirety of the complex, thus providing a reliable, "time-integrated" energy value calculation. In addition, the method eliminates the need for identifying a sub-segment of the ECG complex, such as the P-wave or the R-wave, and also can be used in situations where the P-wave is not easily identifiable, such as patients with arrhythmia.

In another aspect, the calculation of directional energy in an ECG signal complex is disclosed. In particular, the positive directional energy includes the sum of the squared amplitudes of portions of an ECG waveform complex where the energy value is above the ECG signal baseline. Similarly, the negative directional energy includes the sum of the squared amplitudes of portions of the ECG waveform complex where the energy value is below the ECG signal

baseline. This can be applied to the P-wave segment of the ECG waveform complex such that the positive and negative directional energies and their respective ratio serve as an additional indicator of the location within the vasculature of a portion of a vascular access device, such as catheter tip relative to the sino-atrial node (SAN) of the patient's heart from where ECG signals emanate.

Specifically in one embodiment, substantially positive directional energy values indicate a catheter tip position superior to the SAN, while substantially negative directional energy values indicate a catheter tip position inferior to the SAN. If substantial portions of both positive and negative directional energy values are present, this indicates that the catheter tip is proximate to the right atrium. Note that the information provided by the directional energy of the P-wave segment of the ECG waveform complex as discussed above can also be provided by analysis of the amplitude of the P-wave, in one embodiment. Use of the ratio of positive and negative directional energy (or amplitude) of the P-wave segment can also be employed to clarify catheter tip position in situations where other tip location modalities may indicate that the tip can be positioned at either of two possible locations, such as the SVC or the IVC, for instance. Thus the sign (positive or negative) of the P-wave segment net directional energy value can be used to distinguish between SVC and IVC, wherein the net energy is positive for SVC placement and negative for IVC placement. Note that an additional method for distinguishing between tip placement in the IVC vs. the SVC includes the inserted catheter length, wherein the locations in the SVC and IVC where the non-directional energy (discussed further above) has a similar value are typically about 10 cm apart.

Note that practice of the system and methods to be described below enables a user to focus only on the features of the ECG signal waveform that are relevant to the location in the vasculature of the tip of the vascular access device. Also, the user can readily identify and follow the highlighted ECG signal features as they change over time.

FIG. 28 illustrates various elements of a graphical user interface for use with an apparatus, such as the apparatus (100) shown in FIG. 1A, for facilitating guidance of an indwelling catheter or other suitable vascular access device through a vasculature of a patient so as to position a tip thereof in a desired location therein, according to one embodiment. Note that as used herein, "indwelling" includes a position wherein at least a portion of the medical device is disposed within the body of the patient.

As shown, the graphical user interface (GUI) includes various highlighted signal features of interest for two waveforms: both an endovascular ECG signal (3560) displayed on the interface and a skin ECG signal (3570). The graphical user interface further includes various energy values calculated from the endovascular and skin signal waveforms of the ECG signals (3560) and (3570), as will be described. Note that the endovascular and skin ECG signals (3560) and (3570) respectively represent waveforms as detected by an electrode disposed proximate a tip of a vascular access device, such as a catheter, disposed at a point within the patient's vasculature outside the thoracic cavity region, and a skin reference electrode on the patient's skin.

In greater detail, the ECG signal (3570) represents a skin ECG control lead, typically associated with lead III, as described further above. The ECG signal (3560) represents an endovascular ECG signal, typically associated with lead II, measured at the tip of a catheter or other suitable vascular access device disposed in the vasculature outside the thoracic cavity region. An R-peak indicator (3505) highlights

an R-peak of both ECG signals (3560) and (3570) for each waveform complex and is automatically computed by the apparatus 100 (FIG. 1A) and displayed in real-time to enable a user to readily identify the R-peak of each ECG signal. Note that the ECG signals (3560) and (3570) as depicted in the GUI are time-synchronized and each include a plurality of successive waveform complexes, each complex including a P, Q, R, & S-wave element generally corresponding to a single heartbeat, though other sampling directions can also be employed. Also note that the R-peak indicator (3505) (as with the other indicators described herein) marks the R-peak of each complex, though only select waveforms may be marked, if desired.

A P-peak indicator (3510) highlights a P-peak of both ECG signals (3560) and (3570) for each waveform complex therein and is automatically computed by the apparatus (100) and displayed in real-time to enable a user to readily identify the P-peak of each waveform complex. Also, a P-wave segment indicator (3515) highlights a P-wave of both ECG signal (3560) and (3570) for each waveform complex therein and is automatically computed by the apparatus (100) and displayed in real-time to indicate the P-wave portion of each complex of the displayed ECG signal waveforms. Note that the ECG signals as depicted by signal waveforms (3560) and (3570) on the GUI are continually updated as detected by the skin and endovascular electrodes during operation of the apparatus (100). As such, the graphical user interface is continually refreshed during operation of the apparatus (100) so as to depict the ECG signals in real time.

In one embodiment, the highlighted P-wave segment indicator (3515) is determined as follows. The waveforms corresponding to the ECG signals (3560) and 3570 are captured and stored by a processor or other suitable component of the apparatus (100) for at least two seconds, in one embodiment. This is sufficient to capture ECG signals relating to at least one heartbeat of the patient such that at least two consecutive R-peaks bounding a single ECG waveform complex is stored. The points in time of each of the two consecutive R-peaks are marked and the number of samples over which the ECG waveform complex was detected between the two consecutive R-peaks is calculated.

With respect to the presently captured waveform complex extending between the consecutive R-peaks, the P-wave segment is considered by the apparatus (100) in one embodiment to start a predetermined time after the first of the two consecutive R-peaks. Similarly, the P-wave segment is considered to stop a predetermined time before the second of the two consecutive R-peaks. In another embodiment, the start and stop points of the P-wave segment in the present waveform complex are calculated as a percentage of the length of the complex extending between the R-peaks (the R-R interval). For example, the P-wave segment in one embodiment can start at 70% of the R-R interval after the first R-peak and end at 5% of the R-R interval before the second R-peak. This information can be natively included in or programmed into the processor, such as the computer module 140 or other computing portion, of the apparatus (100) so as to be used thereby during P-wave segment detection. Note that other methods of computation of the P-wave segment are possible, based for instance on the assumption that the P-wave segment represents a certain percentage of the R-R interval starting and ending at some predictable points in the R-R cycle. These and other suitable methods for identifying desired components of the waveform are therefore contemplated, as appreciated by one skilled in the art.

Once the P-wave segment has been detected, it can be highlighted on the GUI and appear as the P-wave segment indicator (3515). The detection of the P-wave segment as described above, as well as detection of the R-peak indicator (3505) and P-peak indicator (3510), is continuously repeated for each new waveform complex detected by the apparatus. As such, the GUI in the present embodiment depicts a series of indicators across the screen as the waveform complexes are continuously captured and analyzed to identify the aforementioned complex components.

The above-described method for identifying and highlighting the P-wave segment can be applied to other ECG signals, including those depicted in FIGS. 29-35 herein, which are indicative of detection of ECG signals by the endovascular electrode of an indwelling catheter at different locations within the patient vasculature.

FIG. 28 further shows a field (3530) that displays various peak amplitude values for the respective R-peaks and P-peaks of the waveforms of the ECG signal (3560), captured by the reference skin electrode lead III, and the ECG signal (3570), captured by the endovascular catheter electrode lead II. The values included in the field (3530) and the other fields depicted in the GUI are calculated in the present embodiment by the computer module (140) of the apparatus (100) (FIG. 1A).

FIG. 28 also shows a field (3540) that displays the total energy levels per heartbeat, i.e., its corresponding waveform complex, detected on the ECG signal (3560) by lead II (shown at (3540A)) and on the ECG signal (3570) by lead III (shown at (3540B)). In the present embodiment, the total energy value, E_{RR} , for a waveform complex of either the endovascular ECG signal (3560) (shown at (3540A)) or the skin reference ECG signal (3570) (shown at (3540B)) is calculated using the following equation:

$$E_{RR} = \text{Sum}_{RR} A^2 / \# \text{ of Samples}_{RR}, \quad (1)$$

wherein the squares of the amplitudes of the complex at each discretely sampled portion of the complex between the two R-peaks are summed together, then divided by the number of sampled portions of the complex. Thus, in one example the apparatus (100) samples the ECG signal 100 times between successive R-peaks in order to ascertain the amplitude of the waveform complex at each of those sample points. Equation (1) would therefore include a summation of the square of the amplitudes of the waveform complex at each of the 100 sample points and would be divided by 100. This in turn yields a non-directional total energy value for the sampled waveform complex, wherein "non-directional" indicates that the total energy value is calculated by the apparatus 100 using all portions of the waveform complex irrespective of the polarity of the portion, i.e., negative portions where the energy value is below the ECG signal baseline and positive portions where the energy value is above the ECG signal baseline.

As mentioned further above, the calculated non-directional total energy values (3540A) of the endovascular ECG signal (3560) and (3540B) of the skin ECG signal (3570) for selected waveform complexes between consecutive R-peaks can be monitored by a user as the endovascular electrode at the tip of the catheter is advanced through the vasculature in order to assist the user in determining when the catheter tip has been placed in a desired intravascular position. Again, the method described above in connection with equation (1) can be readily implemented in an algorithm and automated for use by the computer module (140) of the apparatus (100), or other suitable ECG monitoring and/or ECG-based tracking system. Further, the method can take into account

changes in the electrical activity over the entirety of the complex regardless of whether the complex contains positive and/or negative polarity portions, thus providing a reliable, "time-integrated" energy value calculation.

FIG. 28 further shows a field (3550) that displays various energy values and ratios related to the ECG signals (3560) and (3570). In particular, a P-wave field (3550A) is shown, including a positive directional energy value P(+) and a negative directional energy value P(-) and a resultant directional energy value (i.e., the difference of P(+) and P(-)) for a selected waveform complex, e.g., the current monitored heartbeat, of the endovascular lead II ECG signal (3560).

As described further above, the positive directional energy value P(+) includes the sum of the squared amplitudes of portions of the P-wave segment (identified by the P-wave segment indicator (3515)) of the current waveform complex, where the energy value is above the ECG signal baseline. Similarly, the negative directional energy value P(-) includes the sum of the squared amplitudes of portions of the P-wave segment (identified by the P-wave segment indicator (3515)) of the current waveform complex, where the energy value is below the ECG signal baseline.

Thus, the information contained in field (3550A) can serve as an additional indicator to the user of the location within the vasculature of the tip of the catheter, wherein in one embodiment, substantially positive directional energy values indicate a catheter tip position superior to the SAN, while substantially negative directional energy values indicate a catheter tip position inferior to the SAN. If substantial portions of both positive and negative directional energy values are present, this indicates that the catheter tip is proximate to the right atrium. Note that the information provided by the directional energy of the P-wave segment of the ECG waveform complex as discussed above can also be provided by analysis of the amplitude of the P-wave, in one embodiment.

Use of the ratio of positive to negative directional energy of the P-wave segment can also be employed to clarify catheter tip position in situations where other tip location methods, such as reference to the total energy values indicated in the total waveform complex energy field (3540), may indicate that the tip is positioned at either one of two possible locations, such as the SVC or the IVC, for instance. Thus the sign (positive or negative) of the net directional energy value of the P-wave segment as indicated in field (3550A) can be used to distinguish between SVC and IVC, wherein the net energy is positive for SVC placement and negative for IVC placement.

Note that an additional method for distinguishing between tip placement in the IVC vs. the SVC includes the inserted catheter length, wherein the locations in the SVC and IVC where the non-directional energy (discussed further above) has a similar value are typically about 10 cm apart.

Field (3550) further includes field (3550B), which depicts the ratio of the P-peak amplitude and the R-peak of the current endovascular waveform complex, and field (3550C), which depicts the ratio of the R-peak of the current endovascular waveform complex to the R-peak of the current skin waveform complex. These ratios, like the other energy and amplitude values depicted on the GUI, vary in time as the catheter tip including the endovascular electrode is advanced through the vasculature. Also, like the other energy and amplitude values depicted on the GUI, these ratios can be used by the user in determining proper catheter tip placement.

FIG. 29 illustrates various elements of the graphical user interface (GUI) for use with an apparatus, such as the

apparatus (100) shown in FIG. 1A, for facilitating guidance of the catheter or other suitable vascular access device through the patient's vasculature, according to one embodiment. Note that many aspects of the GUI and the information depicted therein are similar to those aspects depicted in FIG. 28; as such, similar numbering conventions are used in FIG. 29 and subsequent figures, and only selected differences will be discussed herein.

As before, the GUI includes various highlighted signal features of interest for the two displayed waveforms, i.e., an endovascular ECG signal (3660) and a skin ECG signal (3670). The highlighted signal features include an R-peak indicator (3605), a P-peak indicator (3610), and a P-wave segment indicator (3615). The GUI of FIG. 29 further includes various energy values calculated from the endovascular and skin signal waveforms of the ECG signals (3660) and (3670), including the fields (3630), (3640), and (3650). The calculations to yield the information depicted in these fields are performed in a manner similar to that described above in connection with FIG. 28.

The ECG signals (3660) and (3670) and the energy and ratio data included in the fields (3630), (3640), and (3650) of FIG. 29 depict one example of waveforms and data detected and calculated when the endovascular electrode associated with the tip of the catheter is positioned in the upper SVC of the vasculature. As such, the information depicted on the GUI such as is seen in FIG. 29 can assist the user to determine when the catheter tip is located in the upper SVC of the patient vasculature.

FIG. 30 illustrates various elements of the graphical user interface (GUI) for use with an apparatus, such as the apparatus (100) shown in FIG. 1A, for facilitating guidance of the catheter or other suitable vascular access device through the patient's vasculature, according to one embodiment. Note that many aspects of the GUI and the information depicted therein are similar to those aspects depicted in FIG. 28; as such, similar numbering conventions are used in FIG. 30, and only selected differences will be discussed herein.

As before, the GUI includes various highlighted signal features of interest for the two displayed waveforms, i.e., an endovascular ECG signal (3760) and a skin ECG signal (3770). The highlighted signal features include an R-peak indicator (3705), a P-peak indicator (3710), and a P-wave segment indicator (3715). The GUI of FIG. 30 further includes various energy values calculated from the endovascular and skin signal waveforms of the ECG signals (3760) and (3770), including the fields (3730), (3740), and (3750). The calculations to yield the information depicted in these fields are performed in a manner similar to that described above in connection with FIG. 28.

The ECG signals (3760) and (3770) and the energy and ratio data included in the fields (3730), (3740), and (3750) of FIG. 30 depict one example of waveforms and data detected and calculated when the endovascular electrode associated with the tip of the catheter is positioned in the lower $\frac{1}{3}^{rd}$ of the SVC of the vasculature. As such, the information depicted on the GUI such as is seen in FIG. 30 can assist the user to determine when the catheter tip is located in the lower $\frac{1}{3}^{rd}$ of the SVC of the patient vasculature.

FIG. 31 illustrates various elements of the graphical user interface (GUI) for use with an apparatus, such as the apparatus (100) shown in FIG. 1A, for facilitating guidance of the catheter or other suitable vascular access device through the patient's vasculature, according to one embodiment. Note that many aspects of the GUI and the informa-

tion depicted therein are similar to those aspects depicted in FIG. 28; as such, similar numbering conventions are used in FIG. 31, and only selected differences will be discussed herein.

As before, the GUI includes various highlighted signal features of interest for the two displayed waveforms, i.e., an endovascular ECG signal (3860) and a skin ECG signal (3870). The highlighted signal features include an R-peak indicator (3805), a P-peak indicator (3810), and a P-wave segment indicator (3815). The GUI of FIG. 31 further includes various energy values calculated from the endovascular and skin signal waveforms of the ECG signals (3860) and (3870), including the fields (3830), (3840), and (3850). The calculations to yield the information depicted in these fields are performed in a manner similar to that described above in connection with FIG. 28.

The ECG signals (3860) and (3870) and the energy and ratio data included in the fields (3830), (3840), and (3850) of FIG. 31 depict one example of waveforms and data detected and calculated when the endovascular electrode associated with the tip of the catheter is positioned in the CAJ of the vasculature. As such, the information depicted on the GUI such as is seen in FIG. 31 can assist the user to determine when the catheter tip is located in the CAJ of the patient vasculature.

FIG. 32 illustrates various elements of the graphical user interface (GUI) for use with an apparatus, such as the apparatus (100) shown in FIG. 1A, for facilitating guidance of the catheter or other suitable vascular access device through the patient's vasculature, according to one embodiment. Note that many aspects of the GUI and the information depicted therein are similar to those aspects depicted in FIG. 28; as such, similar numbering conventions are used in FIG. 32, and only selected differences will be discussed herein.

As before, the GUI includes various highlighted signal features of interest for the two displayed waveforms, i.e., an endovascular ECG signal (3960) and a skin ECG signal (3970). The highlighted signal features include an R-peak indicator (3905), a P-peak indicator (3910), and a P-wave segment indicator (3915). The GUI of FIG. 32 further includes various energy values calculated from the endovascular and skin signal waveforms of the ECG signals (3960) and (3970), including the fields (3930), (3940), and (3950). The calculations to yield the information depicted in these fields are performed in a manner similar to that described above in connection with FIG. 28.

The ECG signals (3960) and (3970) and the energy and ratio data included in the fields (3930), (3940), and (3950) of FIG. 32 depict one example of waveforms and data detected and calculated when the endovascular electrode associated with the tip of the catheter is positioned in the RA of the vasculature. As such, the information depicted on the GUI such as is seen in FIG. 32 can assist the user to determine when the catheter tip is located in the RA of the patient vasculature.

FIG. 33 illustrates various elements of the graphical user interface (GUI) for use with an apparatus, such as the apparatus (100) shown in FIG. 1A, for facilitating guidance of the catheter or other suitable vascular access device through the patient's vasculature, according to one embodiment. Note that many aspects of the GUI and the information depicted therein are similar to those aspects depicted in FIG. 28; as such, similar numbering conventions are used in FIG. 33, and only selected differences will be discussed herein.

As before, the GUI includes various highlighted signal features of interest for the two displayed waveforms, i.e., an endovascular ECG signal (4060) and a skin ECG signal (4070). The highlighted signal features include an R-peak indicator (4005), a P-peak indicator (4010), and a P-wave segment indicator (4015). The GUI of FIG. 33 further includes various energy values calculated from the endovascular and skin signal waveforms of the ECG signals (4060) and (4070), including the fields (4030), (4040), and (4050). The calculations to yield the information depicted in these fields are performed in a manner similar to that described above in connection with FIG. 28.

The ECG signals (4060) and (4070) and the energy and ratio data included in the fields (4030), (4040), and (4050) of FIG. 33 depict one example of waveforms and data detected and calculated when the endovascular electrode associated with the tip of the catheter is positioned in the IVC of the vasculature. As such, the information depicted on the GUI such as is seen in FIG. 33 can assist the user to determine when the catheter tip is located in the IVC of the patient vasculature.

Note that the negative directional energy value P(-) for the endovascular electrode as shown at field (4050A) is greater relative to the positive directional energy value P(+), indicative of the P-wave (highlighted by the P-wave segment indicator (4015)) including a large negative component below the ECG signal baseline for the P-wave of the endovascular ECG signal (4060), a fact that is borne out upon observation of the P-wave thereof. This fact can be employed in one embodiment to discern between catheter tip placement in the lower 1/3 of the SVC or the IVC, where the total energy values as depicted in the fields (3740A) and (3740B) (for the lower 1/3 SVC tip placement scenario shown in FIG. 30) and in the fields (4040A) and (4040B) (for the IVC tip placement scenario shown in FIG. 33) are often similar and do not alone always provide a clear indication of the catheter tip location. In addition to reference to the relatively greater negative directional energy value P(-) with respect to P(+), the user can observe that the total energy of the complex decreased as the IVC is approached by the endovascular electrode of the catheter tip, wherein an increase in total energy is observed as the SVC is approached.

FIG. 34 illustrates various elements of the graphical user interface (GUI) for use with an apparatus, such as the apparatus (100) shown in FIG. 1A, for facilitating guidance of the catheter or other suitable vascular access device through the patient's vasculature, according to one embodiment. Note that many aspects of the GUI and the information depicted therein are similar to those aspects depicted in FIG. 28; as such, similar numbering conventions are used in FIG. 34, and only selected differences will be discussed herein.

As before, the GUI includes various highlighted signal features of interest for the two displayed waveforms, i.e., an endovascular ECG signal (4160) and a skin ECG signal (4170). The highlighted signal features include an R-peak indicator (4105), a P-peak indicator (4110), and a P-wave segment indicator (4115). The GUI of FIG. 34 further includes various energy values calculated from the endovascular and skin signal waveforms of the ECG signals (4160) and (4170), including the fields (4130), (4140), and (4150). The calculations to yield the information depicted in these fields are performed in a manner similar to that described above in connection with FIG. 28.

The ECG signals (4160) and (4170) and the energy and ratio data included in the fields (4130), (4140), and (4150)

of FIG. 34 depict one example of waveforms and data detected and calculated for a patient with arrhythmia. As such, the information depicted on the GUI such as is seen in FIG. 34 can assist the user in placing the catheter tip as desired even in patients encountering arrhythmia.

FIG. 35 illustrates various elements of the graphical user interface (GUI) for use with an apparatus, such as the apparatus (100) shown in FIG. 1A, for facilitating guidance of the catheter or other suitable vascular access device through the patient's vasculature, according to one embodiment. Note that many aspects of the GUI and the information depicted therein are similar to those aspects depicted in FIG. 28; as such, similar numbering conventions are used in FIG. 35, and only selected differences will be discussed herein.

As before, the GUI includes various highlighted signal features of interest for the two displayed waveforms, i.e., an endovascular ECG signal (4260) and a skin ECG signal (4270). The highlighted signal features include an R-peak indicator (4205), a P-peak indicator (4210), and a P-wave segment indicator (4215). The GUI of FIG. 35 further includes various energy values calculated from the endovascular and skin signal waveforms of the ECG signals (4260) and (4270), including the fields (4230), (4240), and (4250). The calculations to yield the information depicted in these fields are performed in a manner similar to that described above in connection with FIG. 28.

The ECG signals (4260) and (4270) and the energy and ratio data included in the fields (4230), (4240), and (4250) of FIG. 35 depict one example of waveforms and data detected and calculated for a patient with arrhythmia when the endovascular electrode associated with the tip of the catheter is positioned in the CAJ of the vasculature. As such, the information depicted on the GUI such as is seen in FIG. 35 can assist the user to determine when the catheter tip is located in the CAJ of the patient vasculature, even in patients encountering arrhythmia.

FIG. 36 shows a table including various energy values and ratios calculated for selected possible locations of the indwelling catheter within the patient vasculature. In particular, the table shows the total energy values of a waveform complex of the skin ECG signal (such as the ECG signal (3570) shown in FIG. 28) and of the endovascular ECG signal (such as the ECG signal (3560) shown in FIG. 28). The total energy values shown in the first two rows of the table correspond to the total energy values shown in the fields (3540A) . . . (4240A) and (3540B) . . . (4240B) of FIGS. 28-35, respectively.

The bottom row of the table shown in FIG. 36 shows the ratio of the total energy values of the above waveform complex for each selected location shown in the table. In the present embodiment, the ratio is calculated using the following equation:

$$R = E_{RR-II} / E_{RR-III} \quad (2)$$

As seen, this ratio employs total energy value (E_{RR-II}) of the waveform from the skin ECG signal (3570) . . . (4270) in order to provide a reference point for evaluating the endovascular total energy value of the waveform complex.

FIG. 37 shows a graph including an endovascular (catheter tip) ECG total energy plot (4310) and a skin ECG total energy plot (4320). In particular, the plot (4310) shows the total energy values of a waveform complex of the endovascular ECG signal (such as the ECG signal (3560) shown in FIG. 28) and the plot (4320) shows the total energy values of the waveform complex of the skin ECG signal (such as the ECG signal (3570) shown in FIG. 28) at selected

possible locations of the catheter tip within the vasculature. The total energy values shown in the two plots (4310) and (4320) correspond to the total energy values shown in the fields (3540A) . . . (4240A) and (3540B) . . . (4240B) of FIGS. 28-35, respectively. As expected, the total energy reflected in the skin ECG signal as shown in plot (4320) remains substantially constant and independent of the catheter tip location during monitoring, with some possible light fluctuations being due to patient respiration during the catheter insertion procedure.

On the skin, as expected, the total energy as reflected in both plots (4310) and (4320) is of a similar value, with the endovascular energy value being slightly higher than that of the skin due to the particular orientation of lead II in the Einthoven triangle (FIG. 18A).

As the catheter tip advances from the insertion point towards the heart, the total energy detected at the tip thereof increases, as shown by the plot (4310). The total energy reaches a maximum value in the right atrium below the sino-atrial node and starts decreasing as the catheter tip advances beyond the right atrium and toward the inferior vena cava. It is therefore appreciated the total energy level measured by an endovascular electrode positioned proximate the tip of the catheter can be used to identify specific locations of the tip within the vasculature. It is thus seen that clear energy thresholds can be established between the different locations of interest.

Note that the total energy levels for each of the different locations shown in FIG. 37 are patient specific, and so comparison with a patient specific reference level is required in the present embodiment in order to accurately identify location of the catheter tip. For example, the energy level at the skin surface for the endovascular electrode could be used as a reference, with energy changes at the catheter tip being compared with this initial level. This in turn enables the same signal (from the endovascular lead II) to be used for reference and tip location estimation. However, this electrode is not operably connected to the apparatus (100) at the beginning of the procedure so as to be able to measure a skin-level measurement, and would be unable to measure the skin level energy after insertion into the vasculature, which skin energy level may change during the catheter insertion procedure due to patient respiration or movement.

FIG. 38 graphically depicts selected possible locations for placement/location of the tip of a catheter or other vascular access device within the vasculature, including the skin at (4410), the SVC at (4420), the lower 1/3 of the SVC at (4430), the CAJ at (4440), the RA at (4450), the IVC at (4460). Of course, other locations can also be identified and used as desired placement locations for the methods described herein.

FIG. 39 shows various elements of the GUI according to another embodiment, wherein an endovascular Doppler ultrasound signal is employed to locate a tip of a catheter or other medical device. As shown, an ultrasound signal (4510) is depicted, including the Doppler spectrum as measured at the tip of the catheter with a Doppler ultrasound probe or the like. Peaks (4530) represent a maximum in blood kinetic energy during a heart beat as measured by the Doppler ultrasound probe. The time interval between two designated peaks (4530) represents the time interval of a heart beat. Based on the peak activity of the heart cycle as detected by Doppler spectrum signal (4510), a region of interest (4540) can be defined corresponding to the atrial depolarization, i.e., a time interval during the heart beat equivalent to the P-wave. Based on energy calculations and changes in energy in the region (4540), the location of the catheter tip can be

assessed. For example, a relatively high blood kinetic energy as detected by the Doppler ultrasound probe is indicative of location within the right atrium, in one embodiment. Note that in terms of the present disclosure dealing with ECG signals, that negative directional energy in the ultrasound example given here signifies the kinetic energy of blood flowing away from the catheter tip (i.e., a negative Doppler shift), and positive directional energy signifies the kinetic energy of blood flowing towards the catheter tip (i.e., a positive Doppler shift). Note further that the total energy, or non-directional energy, described further above in connection with ECG signals signifies in the ultrasound example here the kinetic energy measured by the Doppler ultrasound signal irrespective of the direction of the flow of the blood being measured.

In light of the above, it is therefore appreciated that in addition to ECG signals, other signal types, such as ultrasound (described above), or electromagnetic energy via magnetic or near-infrared signals can be employed in connection with the above-described energy mapping embodiments.

Embodiments of the invention may be embodied in other specific forms without departing from the spirit of the present disclosure. The described embodiments are to be considered in all respects only as illustrative, not restrictive. The scope of the embodiments is, therefore, indicated by the appended claims rather than by the foregoing description. All changes that come within the meaning and range of equivalency of the claims are to be embraced within their scope.

What is claimed is:

1. A system for tracking a location of a medical device within a vasculature of a patient, the system comprising:
 an endovascular electrode disposed on the medical device and capable of detecting an endovascular ECG signal;
 a display for depicting an image of the endovascular ECG signal;
 a storage device including one or more instructions; and
 a module including a processor, the module communicatively coupled to the storage device, wherein when the processor executes the one or more instructions, the processor identifies an endovascular ECG waveform complex of the endovascular ECG signal and calculates an absolute value of an energy of the endovascular ECG waveform complex in order to enable determination of a position of the medical device within the vasculature.

2. The system for tracking as defined in claim 1, wherein the display depicts information relating to the absolute value of the energy of the endovascular ECG waveform complex to enable a clinician to determine the location of the medical device within the vasculature.

3. The system for tracking as defined in claim 1, wherein when the processor executes the one or more instructions, the processor identifies a P-wave segment in the endovascular ECG waveform complex, calculates a positive energy value relating to an amount of energy of the P-wave segment above a baseline of the endovascular ECG signal, and calculates a negative energy value relating to the amount of energy of the P-wave segment below a baseline of the endovascular ECG signal in order to assist in determining the location of the medical device within the vasculature.

4. The system for tracking as defined in claim 1, wherein the endovascular ECG signal is detected via a lead II configuration of Einthoven's triangle, and wherein a skin ECG signal is detected by the system via a lead III configuration of Einthoven's triangle.

49

5. The system for tracking as defined in claim 1, further comprising a graphical user interface displaying a P-wave indicator on the display, the P-wave indicator highlighting a P-wave of the endovascular ECG waveform complex of the endovascular ECG signal.

6. The system for tracking as defined in claim 1, further comprising a graphical user interface displaying a R-peak indicator on the display, the R-peak indicator highlighting a R-peak of the endovascular ECG waveform complex of the endovascular ECG signal.

7. The system for tracking as defined in claim 1, further comprising a graphical user interface displaying a P-peak indicator on the display, the P-peak indicator highlighting a P-peak of the endovascular ECG waveform complex of the endovascular ECG signal.

8. The system for tracking as defined in claim 1, wherein the display is further designed for depicting an image of a skin ECG signal.

9. The system for tracking as defined in claim 8, further comprising a graphical user interface displaying a R-peak indicator on the display, the R-peak indicator highlighting a (i) R-peak of the endovascular ECG waveform complex of the endovascular ECG signal and (ii) a R-peak of a skin ECG waveform complex of the skin ECG signal.

50

10. The system for tracking as defined in claim 9, further comprising a graphical user interface displaying a P-peak indicator on the display, the P-peak indicator highlighting (i) a P-peak of the endovascular ECG waveform complex of the endovascular ECG signal and (ii) a P-peak of the skin ECG waveform complex of the skin ECG signal.

11. The system for tracking as defined in claim 8, further comprising a graphical user interface displaying a P-wave indicator on the display, the P-wave indicator highlighting a P-wave of the endovascular ECG waveform complex of the endovascular ECG signal and a P-wave of the skin ECG waveform complex of the skin ECG signal.

12. The system for tracking as defined in claim 8, further comprising a graphical user interface displaying a P-peak indicator on the display, the P-peak indicator highlighting a P-peak of the endovascular ECG waveform complex of the endovascular ECG signal and a P-peak of the skin ECG waveform complex of the skin ECG signal.

13. The system for tracking as defined in claim 12, further comprising a graphical user interface displaying a P-wave indicator on the display, the P-wave indicator highlighting a P-wave of the endovascular ECG waveform complex of the endovascular ECG signal and a P-wave of the skin ECG waveform complex of the skin ECG signal.

* * * * *

专利名称(译)	使用血管内能量绘图进行导管导航的装置和方法		
公开(公告)号	US9532724	公开(公告)日	2017-01-03
申请号	US13/240171	申请日	2011-09-22
[标]申请(专利权)人(译)	巴德阿克塞斯系统股份有限公司		
申请(专利权)人(译)	BARD接入系统, INC.		
当前申请(专利权)人(译)	BARD接入系统, INC.		
[标]发明人	GRUNWALD SORIN		
发明人	GRUNWALD, SORIN		
IPC分类号	A61B5/04 A61B5/0452 A61B5/00 A61B5/042 A61B5/06 A61M25/01 A61M25/09 A61M25/00		
CPC分类号	A61B5/04017 A61B5/0006 A61B5/042 A61B5/0452 A61B5/06 A61B5/7203 A61B2034/2046 A61M25/003 A61M25/0026 A61M25/0102 A61M25/0147 A61M25/0194 A61M2025/09116 A61B5/063 A61B5/0408 A61B5/044 A61B5/0456 A61B2034/2053 A61M25/09 A61M2025/0166		
代理机构(译)	鲁坦和塔克LLP		
优先权	61/213474 2009-06-12 US 61/282397 2010-02-02 US 61/344732 2010-09-23 US 61/272025 2009-08-10 US		
其他公开文献	US20120059270A1		
外部链接	Espacenet USPTO		

摘要(译)

装置和方法在许多临床应用和设置中获得和使用血管内电描记图。在一个实施例中，一种用于在患者的脉管系统内定位留置医疗装置的方法包括从与留置医疗装置相关联的血管内ECG信号识别血管内ECG波形复合波，然后计算血管内ECG波形的能量的绝对值复合体。然后通过观察血管内ECG波形复合波的预定段的能量的绝对值来确定医疗装置在脉管系统内的位置。

