



US007907996B2

(12) **United States Patent**
Prystowsky et al.

(10) **Patent No.:** **US 7,907,996 B2**
(45) **Date of Patent:** ***Mar. 15, 2011**

(54) **SYSTEM AND METHOD FOR PROCESSING AND PRESENTING ARRHYTHMIA INFORMATION TO FACILITATE HEART ARRHYTHMIA IDENTIFICATION AND TREATMENT**

(75) Inventors: **Eric N. Prystowsky**, Carmel, IN (US); **Lev Korzinov**, San Diego, CA (US); **Eric Baumann**, San Diego, CA (US); **Scott Denis**, Murrieta, CA (US); **Manuel E. Jaime**, Solana Beach, CA (US); **Justin James**, San Diego, CA (US)

(73) Assignee: **CardioNet, Inc.**, Conshohocken, PA (US)

(*) Notice: Subject to any disclaimer, the term of this patent is extended or adjusted under 35 U.S.C. 154(b) by 767 days.

This patent is subject to a terminal disclaimer.

(21) Appl. No.: **11/739,037**

(22) Filed: **Apr. 23, 2007**

(65) **Prior Publication Data**

US 2007/0191723 A1 Aug. 16, 2007

Related U.S. Application Data

(63) Continuation of application No. 10/760,122, filed on Jan. 16, 2004, now Pat. No. 7,212,850.

(60) Provisional application No. 60/525,386, filed on Nov. 26, 2003.

(51) **Int. Cl.**
A61B 5/0402 (2006.01)

(52) **U.S. Cl.** **600/523; 600/518**

(58) **Field of Classification Search** **600/508-523**
See application file for complete search history.

(56) **References Cited**

U.S. PATENT DOCUMENTS

4,173,971 A *	11/1979	Karz	600/515
4,622,979 A	11/1986	Katchis et al.	
4,630,204 A	12/1986	Mortara	
4,920,489 A	4/1990	Hubelbank et al.	
4,938,228 A	7/1990	Righter et al.	

(Continued)

FOREIGN PATENT DOCUMENTS

EP 0 360 412 3/1995

(Continued)

OTHER PUBLICATIONS

Jan Galuszka et al., "Assessment of Spectral Analysis of Heart Rate Variability in Patients With History of Atrial Fibrillation by Means of Age-Dependent Parameters", Biomed. Papers 146(2), 81-85 (2002).

(Continued)

Primary Examiner — Scott M Getzow

(74) *Attorney, Agent, or Firm* — Fish & Richardson P.C.

(57) **ABSTRACT**

A system and method for presenting information relating to heart data can involve operations including identifying arrhythmia events in physiological data obtained for a living being, receiving human assessments of at least a portion of the arrhythmia events, determining a measure of correlation between the human assessments and the identified events, and selectively presenting information regarding the identified events based on the measure of correlation. The operations can also include identifying atrial fibrillation events in physiological data obtained for a living being, obtaining heart rate data for the living being, and presenting information regarding the heart rate data and duration of the atrial fibrillation events together with a common time scale to pictographically represent heart rate trend with atrial fibrillation burden during a defined time period.

28 Claims, 6 Drawing Sheets

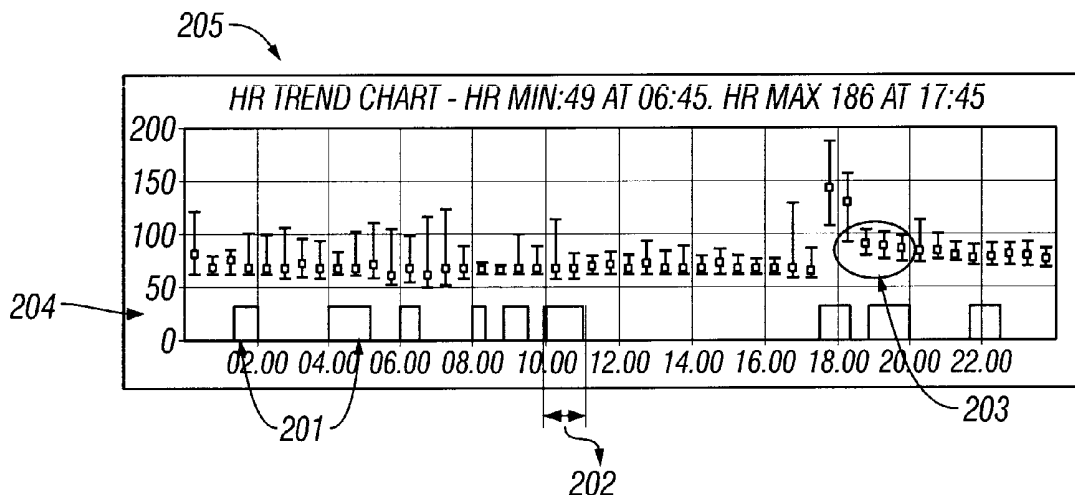

U.S. PATENT DOCUMENTS

4,951,681	A	8/1990	Mortara	
4,958,641	A	9/1990	Digby et al.	
4,977,899	A	12/1990	Digby et al.	
5,191,891	A	3/1993	Righter	
5,197,479	A	3/1993	Hubelbank et al.	
5,217,021	A	6/1993	Steinhaus et al.	
5,226,425	A	7/1993	Righter	
5,365,935	A	11/1994	Righter et al.	
5,421,342	A	6/1995	Mortara	
5,490,515	A	2/1996	Mortara	
5,513,645	A	5/1996	Jacobson et al.	
5,522,396	A	6/1996	Langer et al.	
5,546,950	A	8/1996	Schoeckert et al.	
5,581,369	A	12/1996	Righter et al.	
5,634,468	A	6/1997	Platt et al.	
5,676,153	A	10/1997	Smith et al.	
5,678,562	A	10/1997	Sellers	
5,704,351	A	1/1998	Mortara et al.	
5,730,143	A	3/1998	Schwarzberg	
5,868,680	A	2/1999	Steiner et al.	
5,931,791	A	8/1999	Saltzstein et al.	
5,942,986	A	8/1999	Shabot et al.	
5,966,692	A	10/1999	Langer et al.	
6,064,906	A	5/2000	Langberg et al.	
6,102,856	A	8/2000	Groff et al.	
6,246,907	B1	6/2001	Lin et al.	
6,287,252	B1	9/2001	Lugo	
6,302,844	B1	10/2001	Walker et al.	
6,366,871	B1	4/2002	Geva	
6,409,661	B1	6/2002	Murphy	
6,411,840	B1	6/2002	Bardy	
6,418,340	B1	7/2002	Conley et al.	
6,449,504	B1	9/2002	Conley et al.	
6,485,429	B2	11/2002	Forstner	
6,490,479	B2	12/2002	Bock	
6,524,239	B1	2/2003	Reed et al.	
6,564,077	B2	5/2003	Mortara	
6,583,796	B2	6/2003	Jamar et al.	
6,609,023	B1	8/2003	Fischell et al.	
6,648,827	B2*	11/2003	Heikkila et al.	600/502
6,687,685	B1	2/2004	Sadeghi et al.	
6,697,655	B2	2/2004	Sueppel et al.	
6,937,887	B2	8/2005	Bock	
7,001,334	B2	2/2006	Reed et al.	
7,223,234	B2	5/2007	Stupp et al.	
7,311,665	B2	12/2007	Hawthorne et al.	
7,542,878	B2	6/2009	Nanikashvili	
2002/0099303	A1	7/2002	Bardy	
2002/0128804	A1	9/2002	Geva	
2002/0143266	A1	10/2002	Bock	
2002/0173727	A1	11/2002	Bardy	

2003/0028442	A1	2/2003	Wagstaff et al.
2003/0069486	A1	4/2003	Sueppel et al.
2003/0069487	A1	4/2003	Mortara
2004/0010201	A1	1/2004	Korzinov et al.
2005/0119833	A1	6/2005	Nanikashvili
2005/0203349	A1	9/2005	Nanikashvili
2007/0100213	A1	5/2007	Dossas et al.

FOREIGN PATENT DOCUMENTS

EP	0360412	3/1995
JP	04-300523	10/1992
JP	4300523	10/1992
JP	2000195910	A 7/2000
JP	2003-000559	1/2003
JP	2003130815	5/2003
WO	WO0176461	A2 10/2001
WO	WO0224276	A1 3/2002

OTHER PUBLICATIONS

Med Monitoring Systems, Inc. (Holter, Spiro, DMS, ECG, EKG, APB), <http://www.medmonitoringsystems.com/holtertestanalysis2.html> [Retrieved Nov. 13, 2003].

Massimo Santini et al., "Atrial Fibrillation: The Role of Atrial Defibrillation", *Journal of Interventional Cardiac Electrophysiology* 9, 229-233, 2003.

Jun. 30, 2009, JPO Office Action for patent application No. 2006-541106.

Med Monitoring Systems, Inc. (Holter, Spiro, DMS, ECG, EKG, APB), <http://www.medmonitoringsystems.com/holtertestanalysis2.html>.

Mar. 10, 2008; CA2544926; Office Action from CA Intellectual Property Office, (CA counter-part).

Japanese Patent Office, Nov. 4, 2009, Office Action for Application No. JP2006-5411006.

Biomedical Computer Laboratory, Institute for Biomedical Computing, Washington University, "Progress Report No. 21," Jul. 1, 1984-Jun. 30, 1985, 164 pages.

Savi Wireless—Mobile Cardiac Telemetry Brochure, published by at least May 2009, 12 pages, Medicomp, Melbourne, Florida.

Japanese Patent Application No. 2006-541106, Dispatch Date Nov. 4, 2009, Notification of Reason(s) for Refusal, with translation, 7 pages.

Japanese Patent Application No. 2006-541106, Dispatch Date May 18, 2010, Decision of Refusal, 9 pages, including translation.

European Patent Office, Application No. 04702945.9, filed Jan. 16, 2004, in Supplementary Partial European Search Report, mailed Nov. 11, 2010, 4 pages.

* cited by examiner

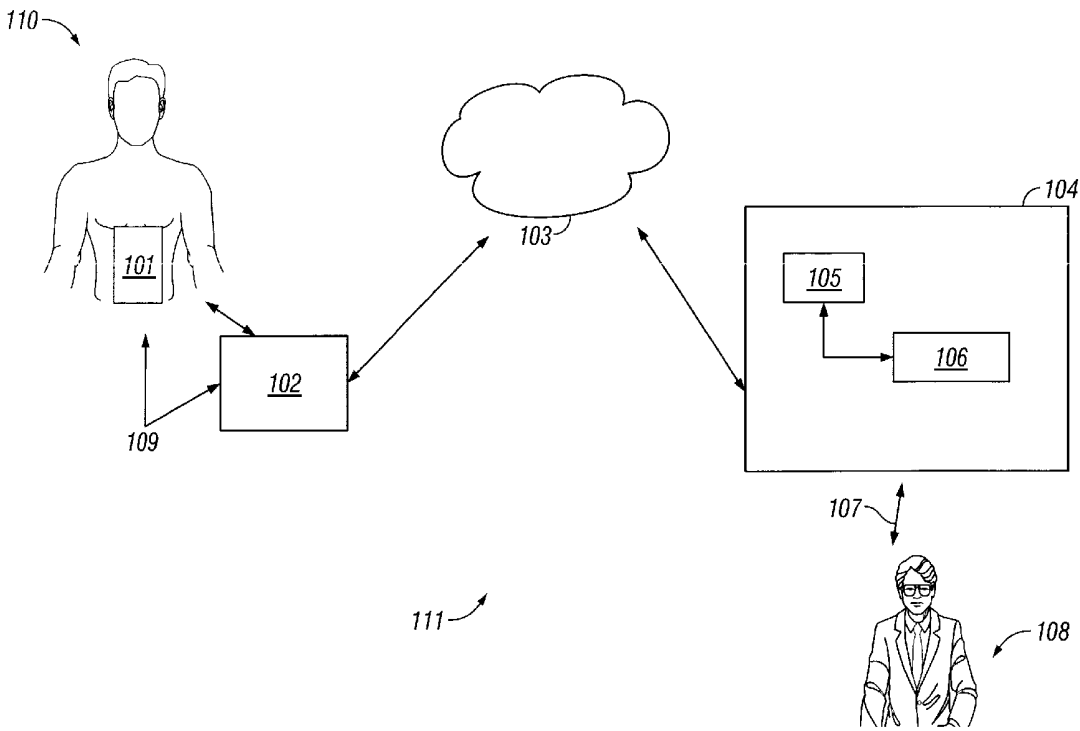

FIG. 1

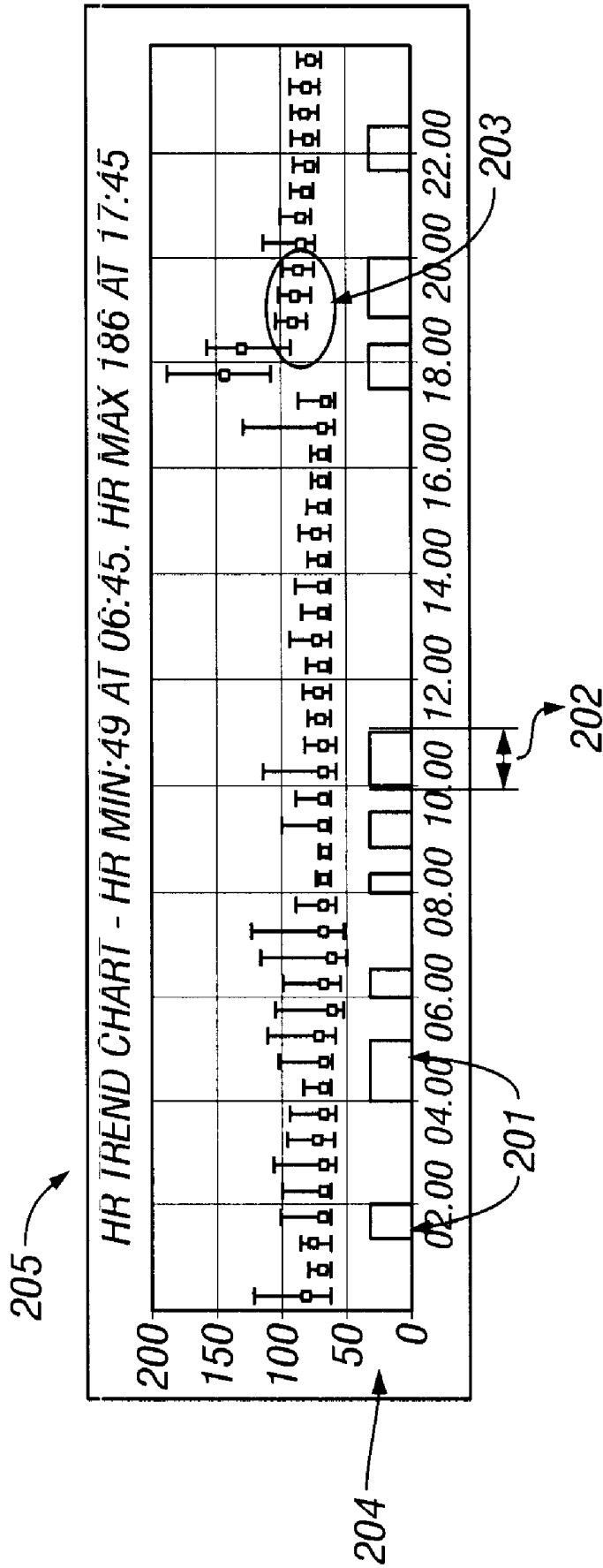

FIG. 2

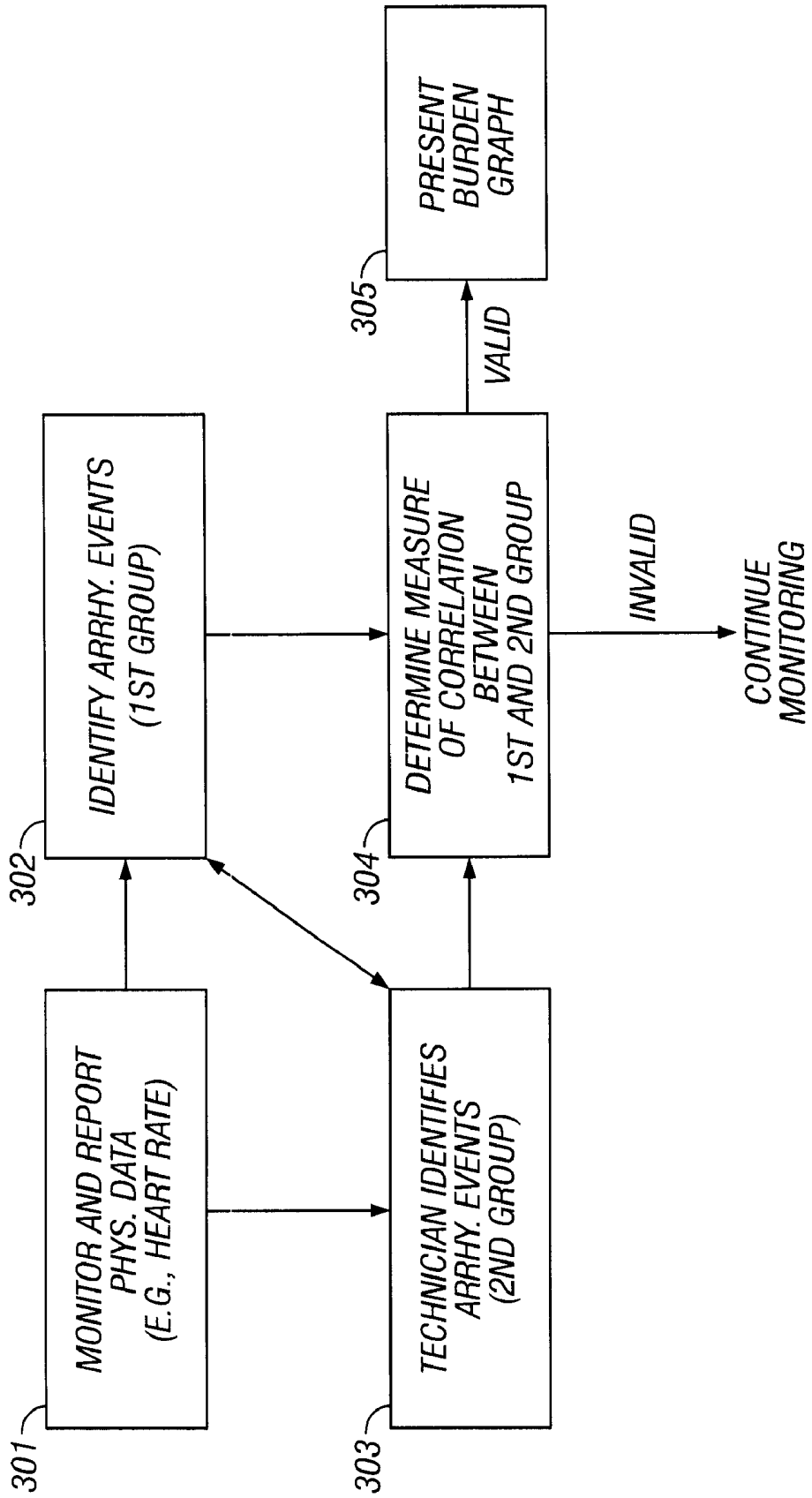

FIG. 3

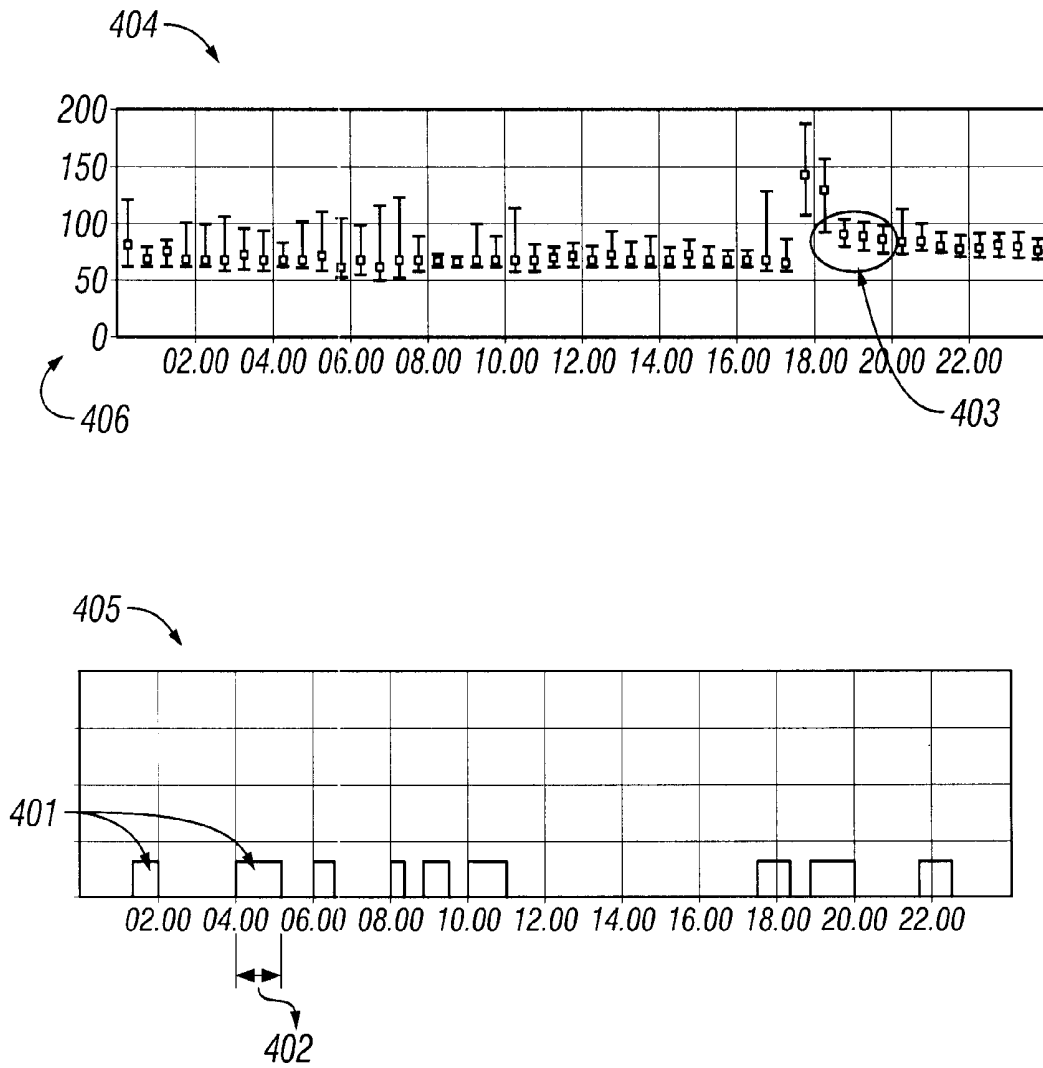

FIG. 4

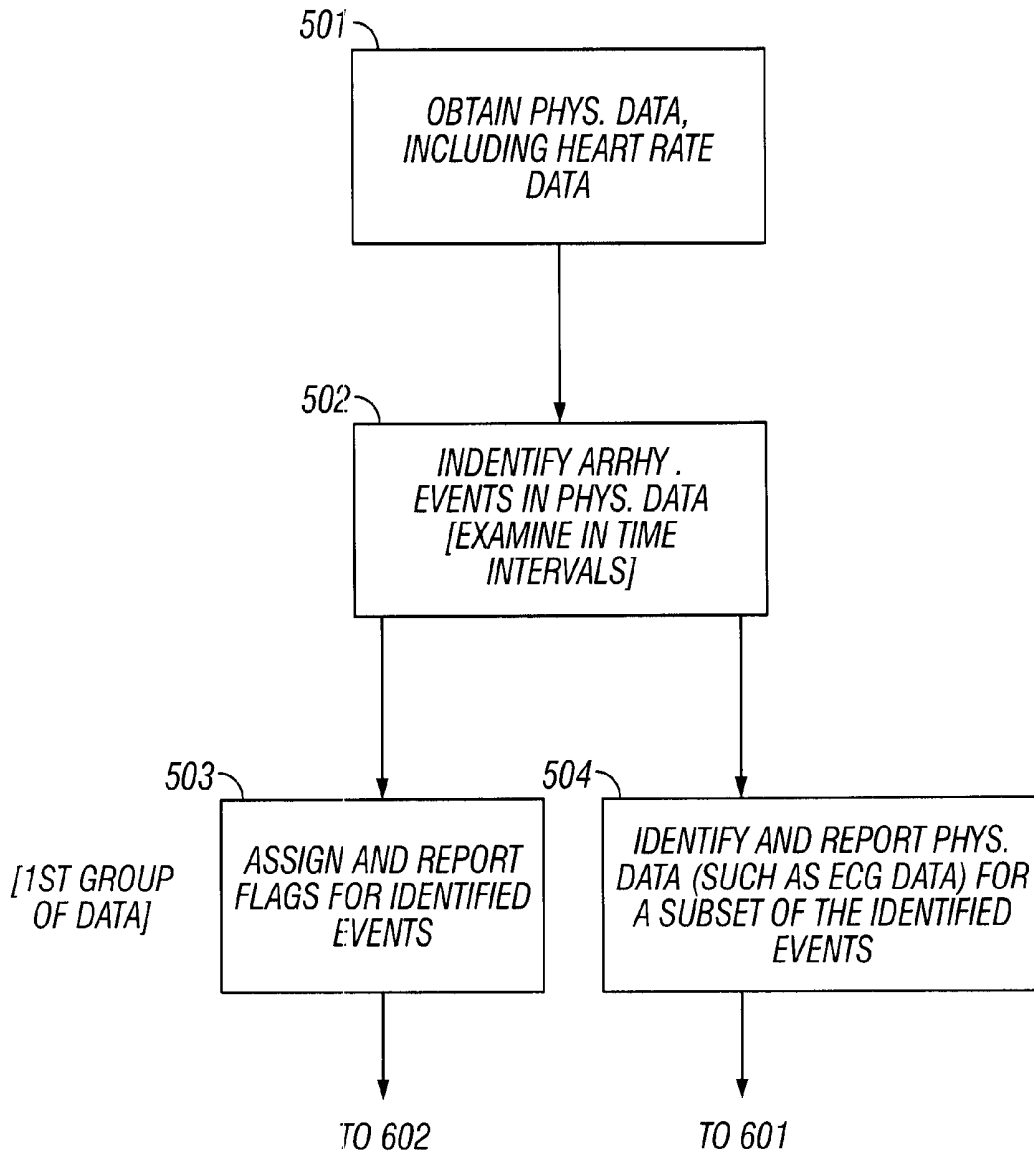

FIG. 5

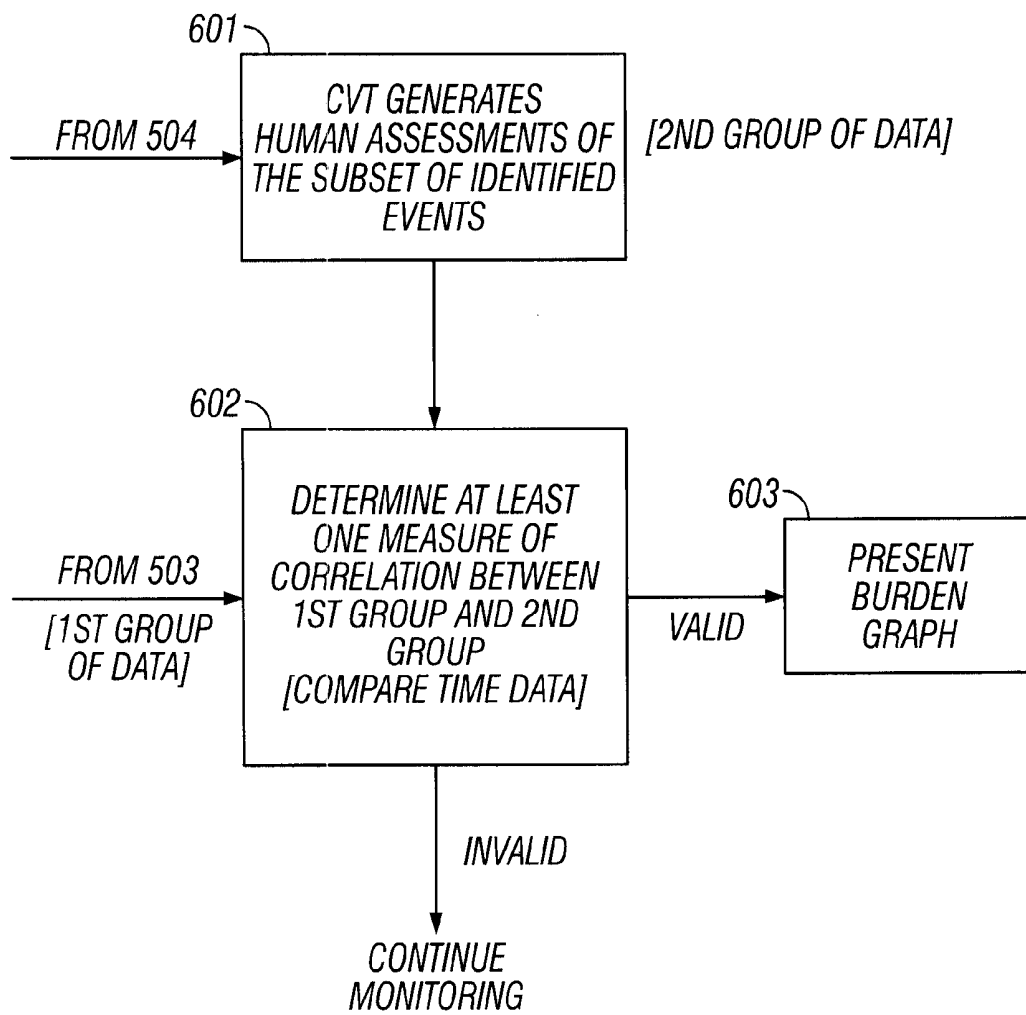

FIG. 6

SYSTEM AND METHOD FOR PROCESSING AND PRESENTING ARRHYTHMIA INFORMATION TO FACILITATE HEART ARRHYTHMIA IDENTIFICATION AND TREATMENT

CROSS REFERENCE TO RELATED APPLICATIONS

This application is a continuation application of and claims the benefit of priority from the U.S. Application entitled "System And Method For Processing And Presenting Arrhythmia Information To Facilitate Heart Arrhythmia Identification And Treatment," filed Jan. 16, 2004, application Ser. No. 10/760,122, and claims priority from U.S. Provisional Application entitled "Presenting Arrhythmia Information to Facilitate Heart Arrhythmia Identification and Treatment," filed Nov. 26, 2003, Application Ser. No. 60/525,386.

BACKGROUND

The present application describes systems and techniques relating to processing and presenting arrhythmia event information from physiological data, for example, selectively presenting atrial fibrillation events to a medical practitioner.

Over the years, various devices have been used for monitoring hearts in living beings. Additionally, systems have been used to collect and report on heart information obtained from patients.

SUMMARY

In general, in one aspect, a heart monitoring system collects heart data from a monitored individual and stores the data at a monitoring center. Collected data can be processed, and graphical representations of the collected information can be presented to medical practitioners to assist in treating heart arrhythmias, such as atrial fibrillation. A system and method can involve operations including identifying arrhythmia events in physiological data obtained for a living being, receiving human assessments of at least a portion of the arrhythmia events, determining a measure of correlation between the human assessments and the identified events, and selectively presenting information regarding the identified events based on the measure of correlation. The operations also can include identifying atrial fibrillation events in physiological data obtained for a living being, obtaining heart rate data for the living being, and presenting information regarding the heart rate data and duration of the atrial fibrillation events together with a common time scale to pictographically represent heart rate trend with atrial fibrillation burden during a defined time period.

One or more of the following advantages can be realized. The heart monitor can loop every twenty-four hours and can automatically transmit heart data at least every twenty-four hours. The system can automatically generate a daily graphical summary of atrial fibrillation (AF) burden for review by a medical practitioner, which can be presented effectively anywhere using one or more communication networks. The AF burden graph can be used for asymptomatic AF detection, drug therapy (rate, rhythm, anti-coagulants), pre/post ablation monitoring, and CHF (congestive heart failure) decompensation. The system can provide an overall sensitivity of 96%, a positive predictivity of over 99%, and artifact rejection of over 90%. In one implementation, the graph only

displays events where AF detection is validated by a technician finding AF in over 50% of the automatically identified events.

The details of one or more embodiments are set forth in the accompanying drawings and the description below. Other features and advantages will become apparent from the description, the drawings, and the claims.

DRAWING DESCRIPTIONS

FIG. 1 illustrates, according to an exemplary embodiment, a system for reporting information related to arrhythmia events.

FIG. 2 shows, according to one embodiment, a graph presenting an example of atrial fibrillation burden and heart rate trend.

FIG. 3 is a diagram illustrating, according to an exemplary embodiment, a procedure for monitoring, processing, and reporting information related to arrhythmia events.

FIG. 4 shows, according to an exemplary embodiment, one graph presenting an example of atrial fibrillation burden and one graph presenting an example of heart rate trend.

FIGS. 5 and 6 are diagrams illustrating, according to another exemplary embodiment, a procedure for monitoring, processing, and reporting information related to arrhythmia events.

DETAILED DESCRIPTION

FIG. 1 illustrates, according to one embodiment, a system for reporting information related to arrhythmia events, such as atrial fibrillation events. In this embodiment, monitoring system 109 can communicate (via devices 101 and 102) ECG (electrocardiogram), cardiac event, and other data to monitoring center 104. The system 109 can include, for example, an implantable medical device (IMD), such as an implantable cardiac defibrillator and an associated transceiver or pacemaker and an associated transceiver, or a monitoring device 101 that a patient 110 wears. Further, monitoring system 109 can include a monitor processing device 102 that can send standard physiological data (received from monitoring device 101) to monitoring center 104 and that can detect arrhythmia events (such as atrial fibrillation events). In one implementation, the devices 101 and 102 are integrated into a single device. Moreover, the system 109 can be implemented using, for example, the CardioNet Mobile Cardiac Outpatient Telemetry (MCOT) device, which is commercially available and provided by CardioNet, Inc of San Diego, Calif.

Monitor processing device 102 can transmit physiological data (including data related to arrhythmia events) through a communication network 103, which can be a local area network (LAN), a landline telephone network, a wireless network, a satellite communication network, or other suitable network to facilitate two-way communication with monitoring center 104. Advantageously, monitoring center 104 can be located in the same location (e.g., in the same room or building) as monitoring system 109 or at some remote location.

The monitoring center 104 can include a monitoring (or display) station 105 and a processing system 106. In one implementation, a cardiovascular technician (CVT) can use the monitoring station 105 to evaluate physiological data received from monitoring system 109, identifying and reporting, among other things, arrhythmia events (such as atrial fibrillation events). The CVT reports these assessments of the physiological data to the processing system 106, which also receives information related to the arrhythmia events identified by monitoring system 109. As will be explained further

below, processing system 106 analyzes this arrhythmia event data (both the human-assessed data from the CVT and the data reported by monitoring system 109) and determines whether to generate a graph (or other similar presentation) related to these events. In certain circumstances, the processing system will send a report related to both arrhythmia and heart rate data to, for example, a physician or other health care provider 108 via transmission path 107—which may be part of the network 103.

FIG. 3 illustrates, according to one embodiment, a procedure for monitoring, processing, and reporting arrhythmia event data (such as data associated with atrial fibrillation events). In this embodiment, the monitoring system 109 (illustrated in FIG. 1) monitors and reports physiological data (including data related to heart rate) at 301. At 302, various parts of this physiological data can be analyzed (for example, RR variability and QRS morphology) and arrhythmia events can be identified based on predefined criteria—the information relating to these events (among other possible information) constituting a first group of data. In one implementation, the monitoring system 109 identifies certain of the arrhythmia events that are urgent or representative and reports those events to both a CVT at 303 and to the processing system at 304. Alternatively, the system could simply report the events identified at 302 to the processing system. Further, at 303, a CVT, using station 105, evaluates various parts of the physiological data received from 302 and/or 301 and also identifies arrhythmia events—the information relating to these human-assessed events (among other possible information) constituting a second group of data. Here, if needed, the CVT can request additional data from monitoring system 109.

At 304, the processing system 106 analyzes both the first and second group of data, determining a measure of correlation between these groups. This process can involve, for example, determining whether a correlation measure exceeds and/or equals a predetermined correlation parameter or whether a correlation measure is less than and/or equals that parameter. If, based on the correlation analysis, the information related to the arrhythmia events is determined to be valid, then the system generates a report relating to both heart rate trend and the arrhythmia events at 305, such as the graph shown in FIG. 2 or the graphs shown in FIG. 4. If, on the other hand, there is insufficient correlation, then the system does not generate a report and monitoring continues.

To illustrate, in one implementation, every ten minutes, the monitoring system 109 transmits a “flag” if it has detected an atrial fibrillation (AF) event in the last ten minutes. In this implementation, the processing system 106 only generates a graph (or graphs) related to heart rate trend and atrial fibrillation burden—such as the graph shown in FIG. 2 or the graphs shown in FIG. 4—if more than 50% of the ten minute flags (generated at 302) match events identified by a CVT (at 303)—a correlation (with respect to the time period at issue) indicating a high positive predictivity for the identification of AF events. If this 50% threshold is not met, then the system does not generate a graph (or graphs) based on the data at issue and simply continues to process data.

The term “atrial fibrillation burden” (or more generally, “arrhythmia event burden”) refers generally to the overall amount of time that a patient is in atrial fibrillation (or arrhythmia) over a specified time period, taking into account the number and duration of episodes. Advantageously, employing pictographic presentations, such as those of FIGS. 2 and 4, a medical practitioner can see whether a patient is more likely to experience an arrhythmia, such as AF, at certain times of the day, and this can affect therapeutic approaches in some cases.

FIG. 2 represents one example of how to pictographically present both heart rate trend and atrial fibrillation burden on a common time scale (to “pictographically present” such data, however, a graph is not required.). The graph 205 contains information relating to, for example, daily AF incidence and time of occurrence 201, AF duration 202, and heart rate (203 and 204). A scale 204 (in this example) indicates heart rate in average beats-per-minute and the dots and lines shown at 203 (for example) indicate values on that scale, standard deviations associated with these values, and heart rates during AF. Further, graph 205 shows heart rate data at 15 minutes and 45 minutes past the hour. Finally, in this graph, the presence of one or more AF events in a given 10-minute period is graphed as a 10-minute interval.

Like FIG. 2, FIG. 4 represents an example of how to pictographically present heart rate trend and atrial fibrillation burden on a common time scale. Although FIG. 4, unlike FIG. 2, uses two graphs, FIG. 4 presents the same information as FIG. 2. Specifically, graphs 404 and 405 contain information relating to, for example, daily AF incidence and time of occurrence 401, AF duration 402, and heart rate (403 and 406). A scale 406 (in this example) indicates heart rate in average beats-per-minute and the dots and lines shown at 403 (for example) indicate values on that scale, standard deviations associated with these values, and heart rates during AF.

FIGS. 5 and 6 are diagrams illustrating another implementation of the invention. Specifically, at 501, the system 111, employing monitoring system 109, obtains physiological data, including heart rate data. In turn, at 502, the system identifies the presence of arrhythmia events (such as AF events) in this physiological data, examining this data in time intervals. At 503, the system assigns flags indicating the presence of arrhythmia events and reports those flags—which represent a first group of data—to the processing system. Similarly, at 504, the system identifies and reports physiological data, such as ECG data, for a subset of the events identified at 502 and reported at 503. Notably, the system, in this implementation, need not report physiological data for each flag assigned at 503, but need only report data associated with the most significant events identified at 502, thereby minimizing the data sent to a CVT.

At 601, the CVT analyzes this data and reports whether arrhythmia events have occurred, thereby generating a second group of data. The processing system then determines (at 602), based on comparing time stamps associated with each group of data, at least one measure of correlation between the first group of data and the second group of data. To illustrate, if enough of the human-assessed events reported at 601 match the events reported at 503, then the system determines that the data is valid, that is, that there is a high positive predictivity for the identification of arrhythmia events. If such a determination is made, the data associated with each flag reported at 503 is pictographically presented in a form such as FIG. 2 or FIG. 4. Significantly, in this implementation, while this pictographic representation can contain all such data, the CVT need only review a subset of this data. In short, the system achieves increased accuracy in the presentation of information relating to arrhythmia events while minimizing the data that the CVT reviews.

The disclosed system and all of the functional operations described and illustrated in this specification can be implemented in digital electronic circuitry, or in computer hardware, firmware, software, or in combinations of the foregoing. Apparatus can be implemented in a software product (e.g., a computer program product) tangibly embodied in a machine-readable storage device for execution by a programmable processor, and processing operations can be performed by a

programmable processor executing a program of instructions to perform functions by operating on input data and generating output. Further, the system can be implemented advantageously in one or more software programs that are executable on a programmable system. This programmable system can include the following: 1) at least one programmable processor coupled to receive data and instructions from, and to transmit data and instructions to, a data storage system; 2) at least one input device; and 3) at least one output device. Moreover, each software program can be implemented in a high-level procedural or object-oriented programming language, or in assembly or machine language if desired; and in any case, the language can be a compiled or an interpreted language.

Also, suitable processors include, by way of example, both general and special purpose microprocessors. Generally, a processor will receive instructions and data from a read-only memory, a random access memory, and/or a machine-readable signal (e.g., a digital signal received through a network connection). Generally, a computer will include one or more mass storage devices for storing data files. Such devices can include magnetic disks, such as internal hard disks and removable disks, magneto-optical disks, and optical disks. Storage devices suitable for tangibly embodying software program instructions and data include all forms of non-volatile memory, including, by way of example, the following: 1) semiconductor memory devices, such as EPROM (electrically programmable read-only memory); EEPROM (electrically erasable programmable read-only memory) and flash memory devices; 2) magnetic disks such as internal hard disks and removable disks; 3) magneto-optical disks; and 4) CD-ROM disks. Any of the foregoing can be supplemented by, or incorporated in, ASICs (application-specific integrated circuits).

To provide for interaction with a user (such as the CVT), the system can be implemented on a computer system having a display device such as a monitor or LCD (liquid crystal display) screen for displaying information to the user and a keyboard and a pointing device such as a mouse or a trackball by which the user can provide input to the computer system. The computer system can be programmed to provide a graphical user interface through which computer programs interact with users.

Finally, while the foregoing system has been described in terms of particular implementations, other embodiments are within the scope of the following claims. For example, the disclosed operations can be performed in a different order and still achieve desirable results. Moreover, the system need not employ 10-minute intervals; many different time intervals are possible (as is, no interval at all), including 1 minute, 30 second, and 30-minute intervals. Indeed, because time intervals are not required, the graphs of FIGS. 2 and 4 could be modified to show continuous heart rate trend (accompanied by corresponding AF data) rather than just specific instances of this trend. Further, while FIGS. 2 and 4 show examples of (among other things) pictographically presenting atrial fibrillation burden (one type of arrhythmia event burden), one could present the same or similar information for another type of arrhythmia event. In fact, one could employ both the format and procedures associated with generating FIG. 2 or FIG. 4 (or a similar figure) to pictographically present information related to a number of different types of arrhythmia event burdens.

What is claimed is:

1. A machine-implemented method comprising:
identifying atrial fibrillation events in physiological data obtained for a living being, wherein identifying atrial fibrillation events comprises examining the physiologi-

cal data in multiple time intervals, and identifying intervals in which at least one atrial fibrillation event has occurred;

obtaining heart rate data for the living being;
receiving a human assessment of a subset of the identified atrial fibrillation events; and

based on the human assessment of the subset of the identified atrial fibrillation events, pictographically presenting, using a common time scale, information regarding the heart rate data for the multiple time intervals during a defined time period in alignment with indications of atrial fibrillation activity for the identified intervals, according to the identified atrial fibrillation events, during the defined time period such that heart rate trend is presented with atrial fibrillation burden, wherein pictographically presenting information regarding the heart rate data comprises displaying for each of the multiple time intervals a range of heart rates and a heart rate average.

2. The method of claim 1,
further comprising determining that the identified atrial fibrillation events are valid when a threshold percentage of the identified atrial fibrillation events match events identified by the human assessment; and
wherein pictographically presenting based on the human assessment comprises pictographically presenting based on the determining.

3. The method of claim 2, wherein pictographically presenting the indications of atrial fibrillation activity comprises presenting information regarding duration of the identified atrial fibrillation events during the defined time period.

4. The method of claim 2, wherein the heart rate data comprise information presented in beats-per-minute.

5. The method of claim 4, wherein the range of heart rates comprises standard deviation of heart rate.

6. The method of claim 2, wherein pictographically presenting information comprises presenting the heart rate trend juxtaposed with the atrial fibrillation burden.

7. The method of claim 2, wherein pictographically presenting information comprises presenting heart rate trend and atrial fibrillation burden on the same graph.

8. The method of claim 2, wherein pictographically presenting information comprises presenting heart rate trend and atrial fibrillation burden on different graphs.

9. The method of claim 2, further comprising receiving input specifying the defined time period.

10. The method of claim 2, further comprising displaying an indication of a time interval of the multiple time intervals having a minimum heart rate for the multiple time intervals.

11. The method of claim 2, further comprising displaying an indication of a time interval of the multiple time intervals having a maximum heart rate for the multiple time intervals.

12. An article comprising a machine-readable medium embodying information indicative of instructions that when performed by one or more machines result in operations comprising:

identifying atrial fibrillation events in physiological data obtained for a living being, wherein identifying atrial fibrillation events comprises examining the physiological data in multiple time intervals, and identifying intervals in which at least one atrial fibrillation event has occurred;

obtaining heart rate data for the living being;
receiving a human assessment of a subset of the identified atrial fibrillation events; and

based on the human assessment of the subset of the identified atrial fibrillation events, pictographically present-

ing, using a common time scale, information regarding the heart rate data for the multiple time intervals during a defined time period in alignment with indications of atrial fibrillation activity for the identified intervals, according to the identified atrial fibrillation events, during the defined time period such that heart rate trend is presented with atrial fibrillation burden, wherein pictographically presenting information regarding the heart rate data comprises displaying for each of the multiple time intervals a range of heart rates and a heart rate average.

13. The article of claim **12**,

determining that the identified atrial fibrillation events are valid when a threshold percentage of the identified events match events identified by the human assessment; and

wherein pictographically presenting based on the human assessment comprises pictographically presenting based on the determining.

14. The article of claim **13**, wherein pictographically presenting the indications of atrial fibrillation activity comprises presenting information regarding duration of the identified atrial fibrillation events during the defined time period.

15. The article of claim **13**, wherein pictographically presenting information comprises presenting the heart rate trend juxtaposed with the atrial fibrillation burden.

16. The article of claim **13**, wherein the operations further comprise receiving input specifying the defined time period.

17. The article of claim **13**, wherein the operations further comprise displaying an indication of a time interval of the multiple time intervals having a maximum heart rate for the multiple time intervals.

18. An apparatus comprising:

means for identifying atrial fibrillation events in physiological data obtained for a living being based on examination of the physiological data in multiple time intervals to identify intervals in which at least one atrial fibrillation event has occurred;

means for obtaining heart rate data for the living being;

means for receiving a human assessment of a subset of the identified atrial fibrillation events; and

means for pictographically presenting, based on the human assessment of the subset of the identified atrial fibrillation events, information regarding the heart rate data for the multiple time intervals during a defined time period in alignment with indications of atrial fibrillation activity for the identified intervals, according to the identified atrial fibrillation events, during the defined time period such that heart rate trend is presented with atrial fibrillation burden, and a range of heart rates and a heart rate average are displayed for each of the multiple time intervals.

19. The apparatus of claim **18**, further comprising means for determining that the identified atrial fibrillation events are valid when a threshold percentage of the identified events match events identified by the human assessment; and

wherein the means for pictographically presenting is coupled to operate based on output of the means for determining.

20. The apparatus of claim **19**, wherein the indications of atrial fibrillation activity comprise information regarding duration of the identified atrial fibrillation events during the defined time period.

21. The apparatus of claim **19**, wherein the means for pictographically presenting comprises means for presenting the heart rate trend juxtaposed with the atrial fibrillation burden.

22. The apparatus of claim **19**, further comprising means for receiving input specifying the defined time period.

23. A system for reporting information related to arrhythmia events comprising:

a monitoring system configured to process and report physiological data, including heart rate data, for a living being, configured to identify atrial fibrillation events from the physiological data, and configured to examine the physiological data in multiple time intervals to identify intervals in which at least one atrial fibrillation event has occurred;

a monitoring station for receiving the physiological data from the monitoring system; and

a processing system configured to:

receive a human assessment of a subset of the identified atrial fibrillation events, and

pictographically present based on the human assessment of the subset of the identified atrial fibrillation events, information regarding the heart rate data for the multiple time intervals during a defined time period in alignment with indications of atrial fibrillation activity for the identified intervals, according to the identified atrial fibrillation events, during the defined time period such that heart rate trend is presented with atrial fibrillation burden, and a range of heart rates and a heart rate average are displayed for each of the multiple time intervals.

24. The system of claim **23**, wherein the processing system is configured to determine that the identified atrial fibrillation events are valid when a threshold percentage of the identified events match events identified by the human assessment, and configured to present the information regarding the heart rate data based on said determination.

25. The system of claim **24**, wherein the processing system is configured to display an indication of a time interval of the multiple time intervals having a maximum heart rate for the multiple time intervals.

26. The system of claim **24**, wherein the indications of atrial fibrillation activity comprise duration of the identified atrial fibrillation events during the defined time period.

27. The system of claim **24**, wherein the processing system is configured to present the heart rate trend juxtaposed with the atrial fibrillation burden.

28. The system of claim **24**, wherein the processing system is configured to receive input specifying the defined time period.

专利名称(译)	用于处理和呈现心律失常信息以促进心律失常识别和治疗的系统和方法		
公开(公告)号	US7907996	公开(公告)日	2011-03-15
申请号	US11/739037	申请日	2007-04-23
申请(专利权)人(译)	CARDIONET INC.		
当前申请(专利权)人(译)	宝马制造有限责任公司		
[标]发明人	PRYSTOWSKY ERIC N KORZINOV LEV BAUMANN ERIC DENIS SCOTT JAIME MANUEL E JAMES JUSTIN		
发明人	PRYSTOWSKY, ERIC N. KORZINOV, LEV BAUMANN, ERIC DENIS, SCOTT JAIME, MANUEL E. JAMES, JUSTIN		
IPC分类号	A61B5/0402 A61B5/00 A61B5/0245 A61B5/044 A61B5/046		
CPC分类号	A61B5/0006 A61B5/046 A61B5/0245 A61B5/044 A61B5/7246 A61B5/7282 A61B5/742		
代理机构(译)	FISH & RICHARDSON P.C.		
优先权	60/525386 2003-11-26 US		
其他公开文献	US20070191723A1		
外部链接	Espacenet USPTO		

摘要(译)

用于呈现与心脏数据有关的信息的系统和方法可以涉及包括识别为生物获得的生理数据中的心律失常事件，接收对至少一部分心律失常事件的人体评估，确定人类评估与之间的相关性度量的操作。所识别的事件，并基于相关性度量选择性地呈现关于所识别的事件的信息。该操作还可以包括识别为生物获得的生理数据中的心房颤动事件，获得生物的心率数据，并且以象形方式呈现关于心率数据和心房颤动事件的持续时间的信息以及共同的时间尺度。表示在规定时间内心房颤动负荷的心率趋势。

