



US 20040147981A1

(19) **United States**

(12) **Patent Application Publication**  
**Bardy**

(10) **Pub. No.: US 2004/0147981 A1**

(43) **Pub. Date: Jul. 29, 2004**

(54) **SYSTEM AND METHOD FOR COLLECTION AND ANALYSIS OF PATIENT INFORMATION FOR AUTOMATED REMOTE PATIENT CARE**

**Publication Classification**

(51) **Int. Cl.<sup>7</sup> ..... A61N 1/08**

(52) **U.S. Cl. .... 607/60**

(76) **Inventor: Gust H. Bardy, Seattle, WA (US)**

(57) **ABSTRACT**

Correspondence Address:  
**Law Offices of Patrick J.S. Inouye**  
**Suite 258**  
**810 Third Avenue**  
**Seattle, WA 98104 (US)**

A system for collection and analysis of patient information for automated remote patient care is presented. A medical device adapted to be implanted for an individual patient regularly records and stores measures sets containing individual measures which each relate to patient information. A database collects one or more patient care records organized to include a plurality of the collected measures sets, and stores the collected measures set into a patient care record for the individual patient within a database. A server periodically receives a set of the collected measures from the medical device adapted to be implanted, and analyzes one or more of the collected measures sets in the patient care record for the individual patient relative to one or more other collected measures sets stored in the database server to determine a patient status indicator.

(21) **Appl. No.: 10/646,104**

(22) **Filed: Aug. 22, 2003**

**Related U.S. Application Data**

(63) Continuation of application No. 09/948,307, filed on Sep. 6, 2001, which is a continuation of application No. 09/324,894, filed on Jun. 3, 1999, now Pat. No. 6,312,378.

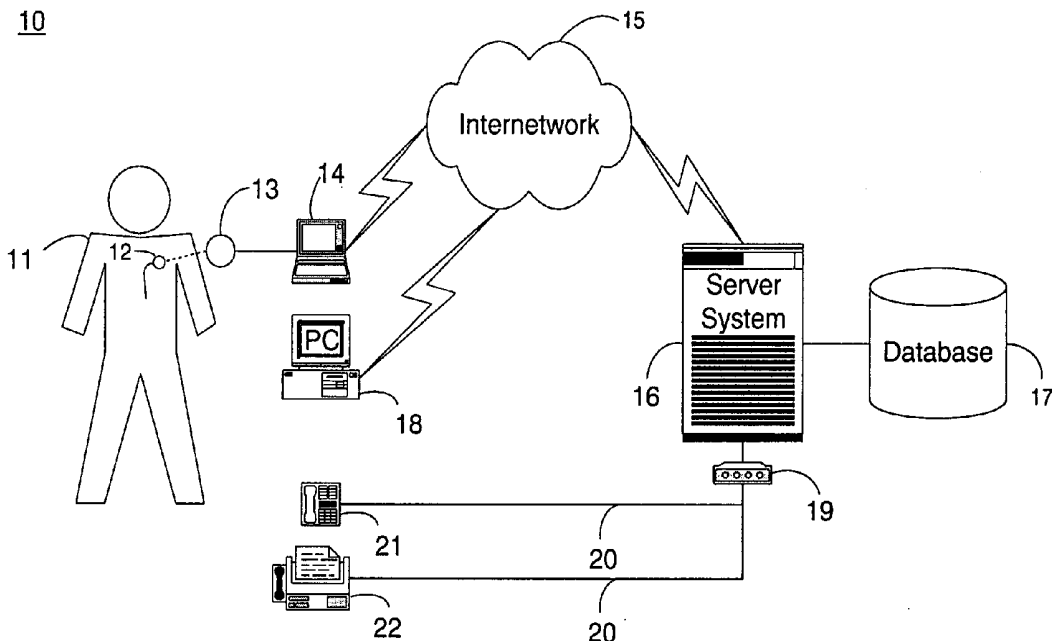

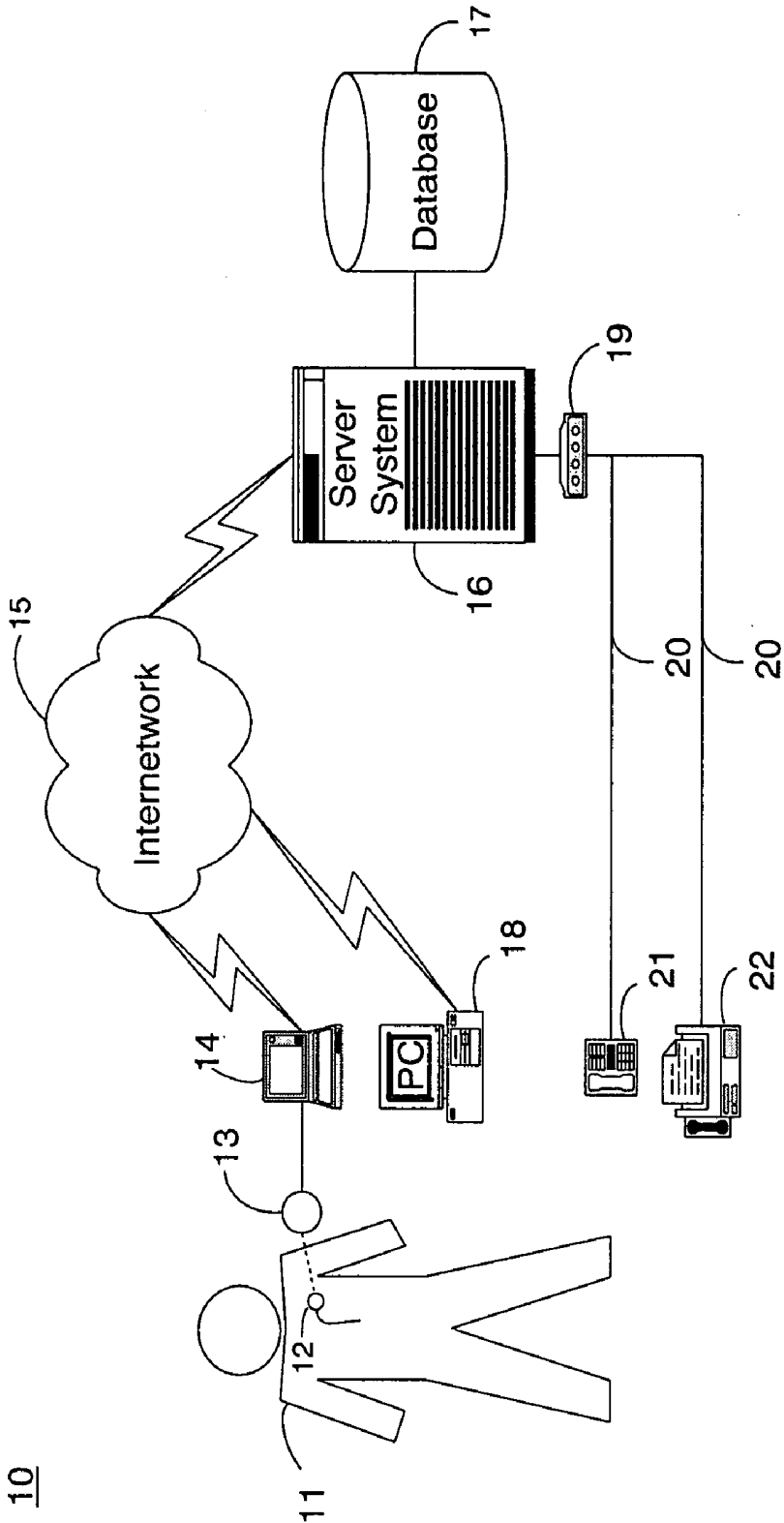

Figure 1.

10

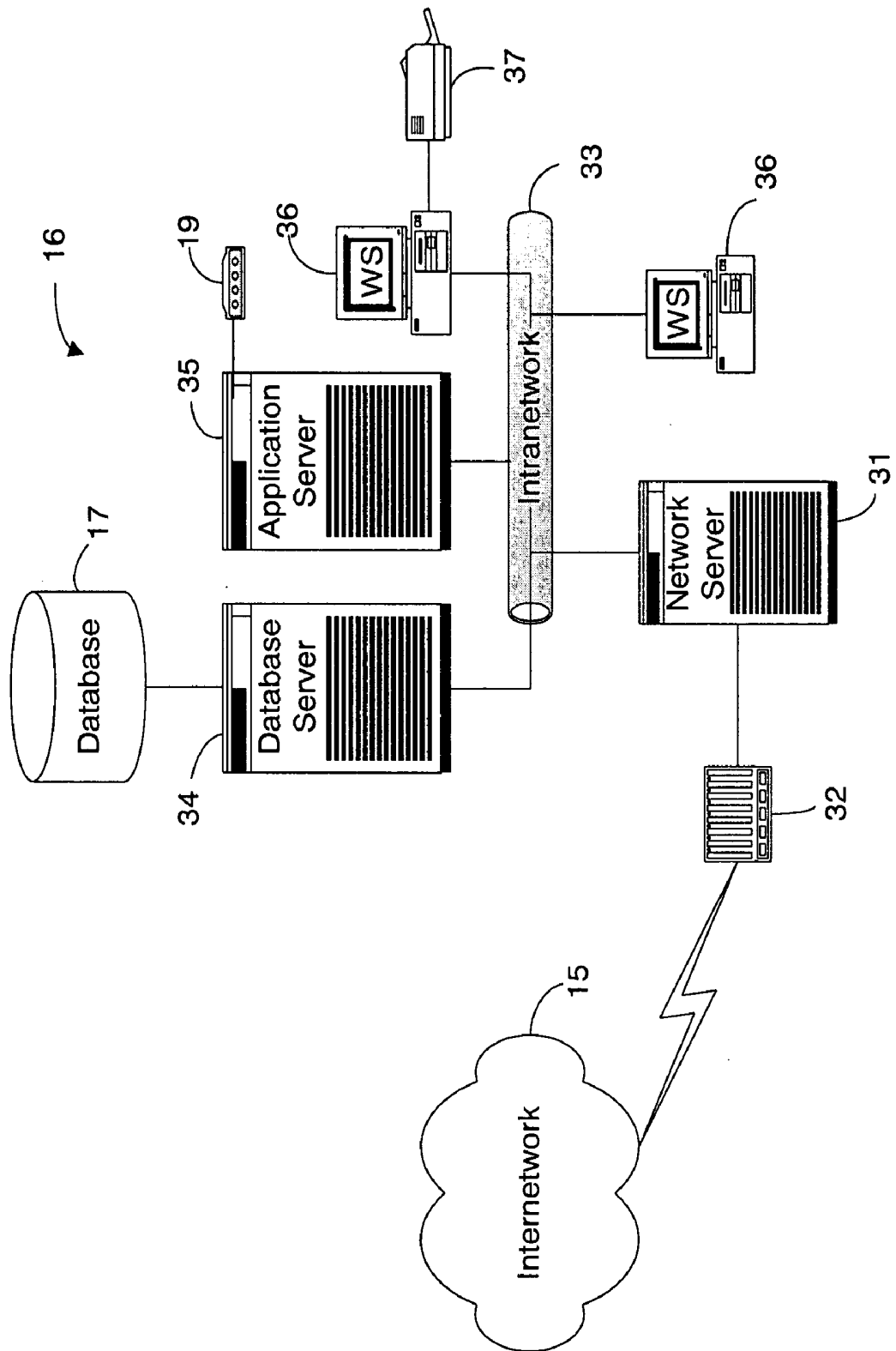

Figure 2.

Figure 3.

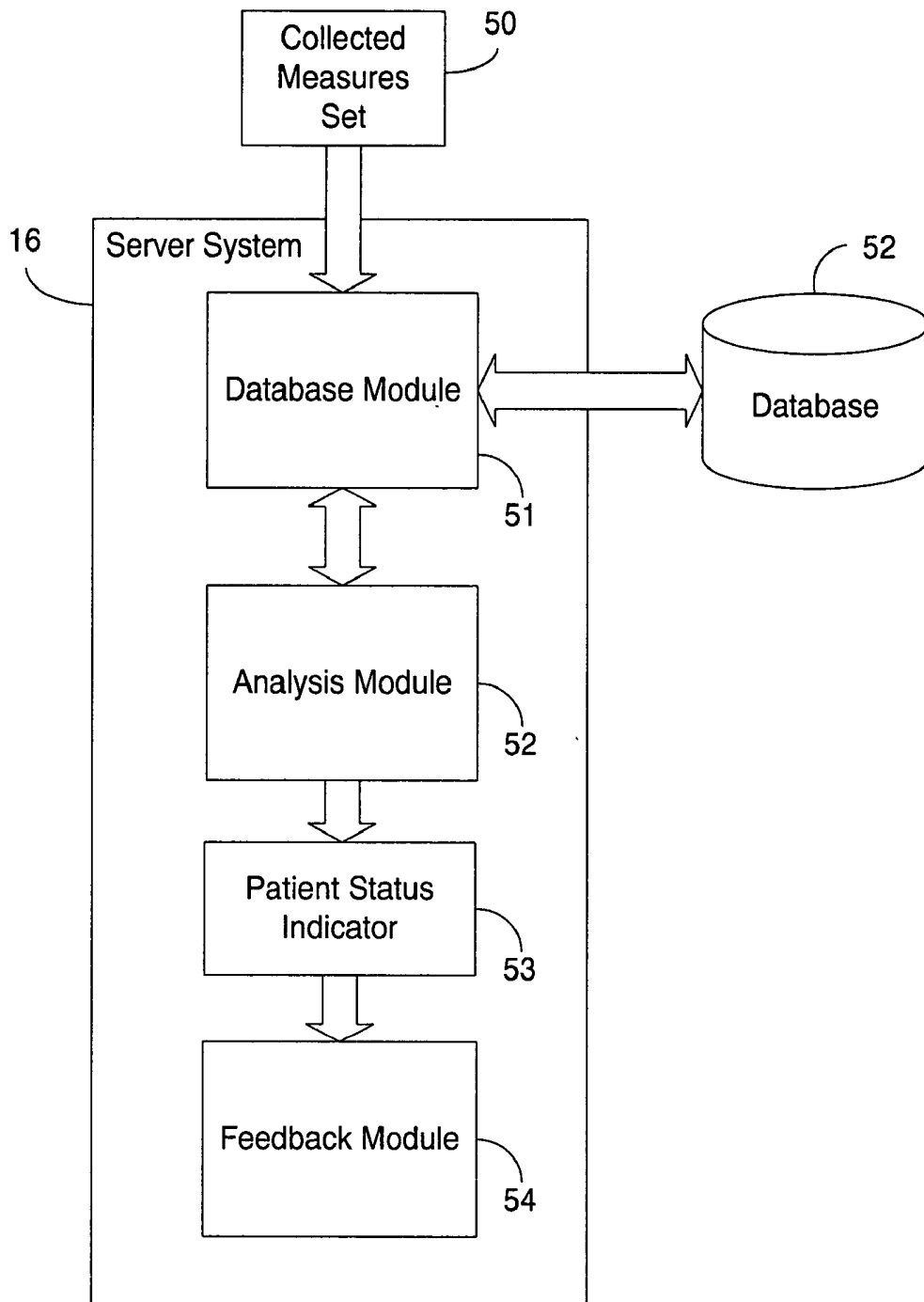
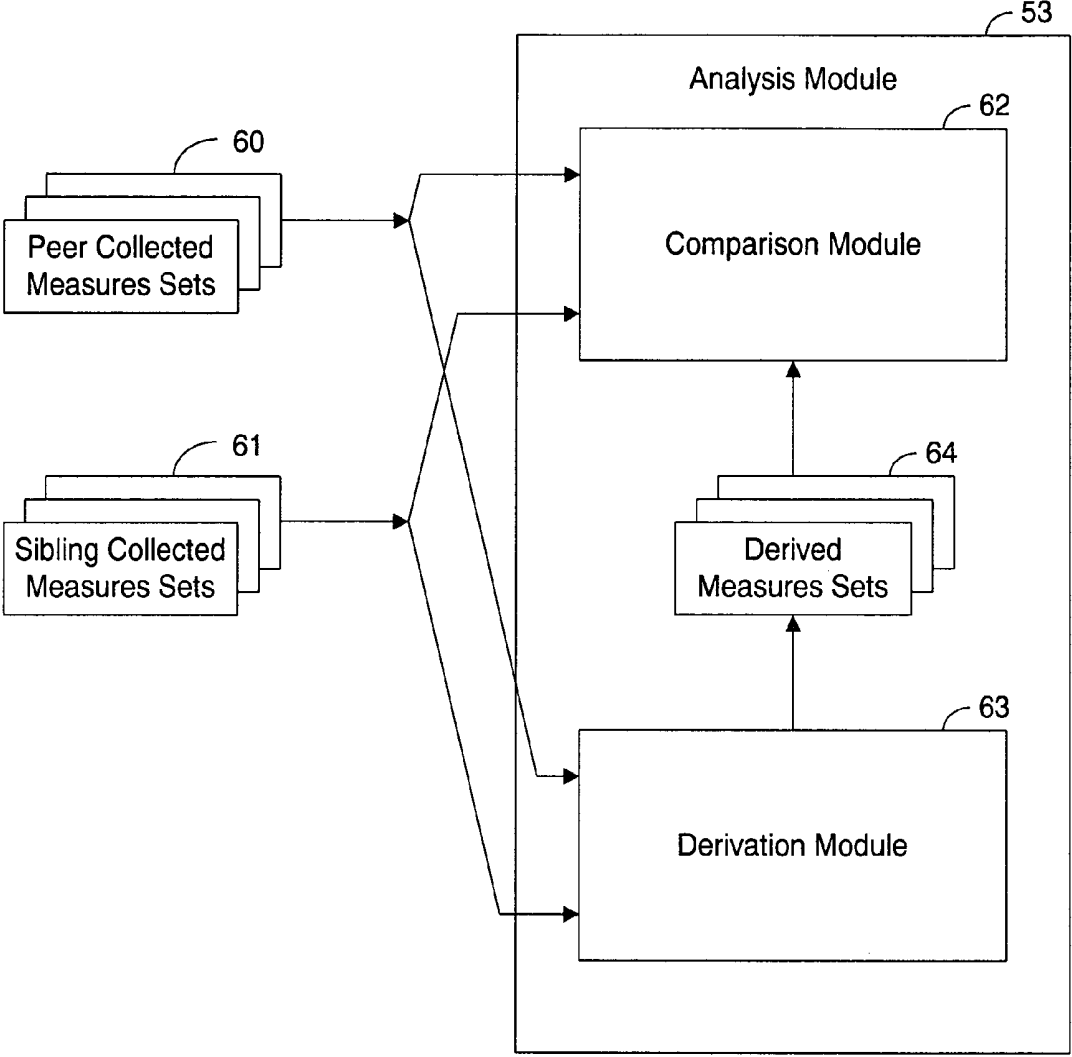

Figure 4.



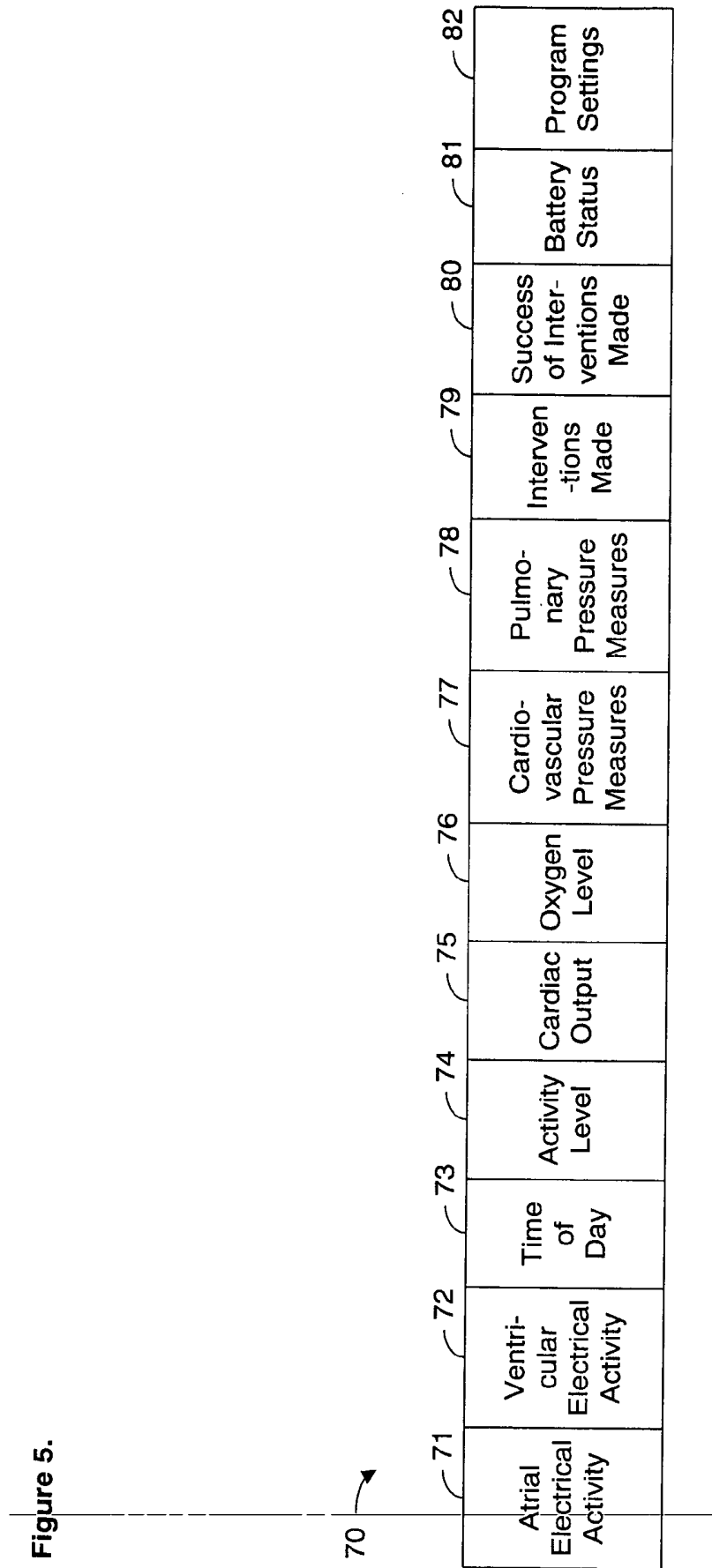

Figure 6.

Patient 1

Set 0				Set n-2	Set n-1	Set n
$X_0$	•	•	•	$X_{n-2}$	$X_{n-1}$	$X_n$
$Y_0$	•	•	•	$Y_{n-2}$	$Y_{n-1}$	$Y_n$
$Z_0$	•	•	•	$Z_{n-2}$	$Z_{n-1}$	$Z_n$

*time* →

Patient 2

Set 0				Set n-2	Set n-1	Set n
$X_{0'}$	•	•	•	$X_{n-2'}$	$X_{n-1'}$	$X_{n'}$
$Y_{0'}$	•	•	•	$Y_{n-2'}$	$Y_{n-1'}$	$Y_{n'}$
$Z_{0'}$	•	•	•	$Z_{n-2'}$	$Z_{n-1'}$	$Z_{n'}$

*time* →

Patient 3

Set 0				Set n-2	Set n-1	Set n
$X_{0''}$	•	•	•	$X_{n-2''}$	$X_{n-1''}$	$X_{n''}$
$Y_{0''}$	•	•	•	$Y_{n-2''}$	$Y_{n-1''}$	$Y_{n''}$
$Z_{0''}$	•	•	•	$Z_{n-2''}$	$Z_{n-1''}$	$Z_{n''}$

*time* →

Figure 7.

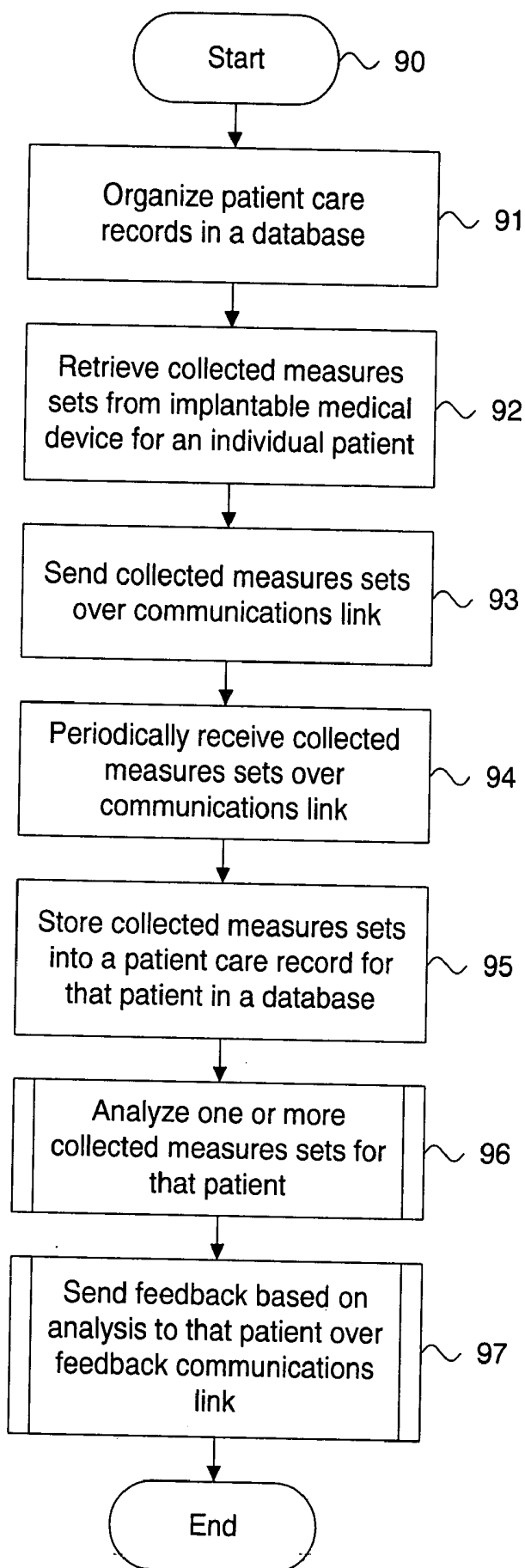

Figure 8.

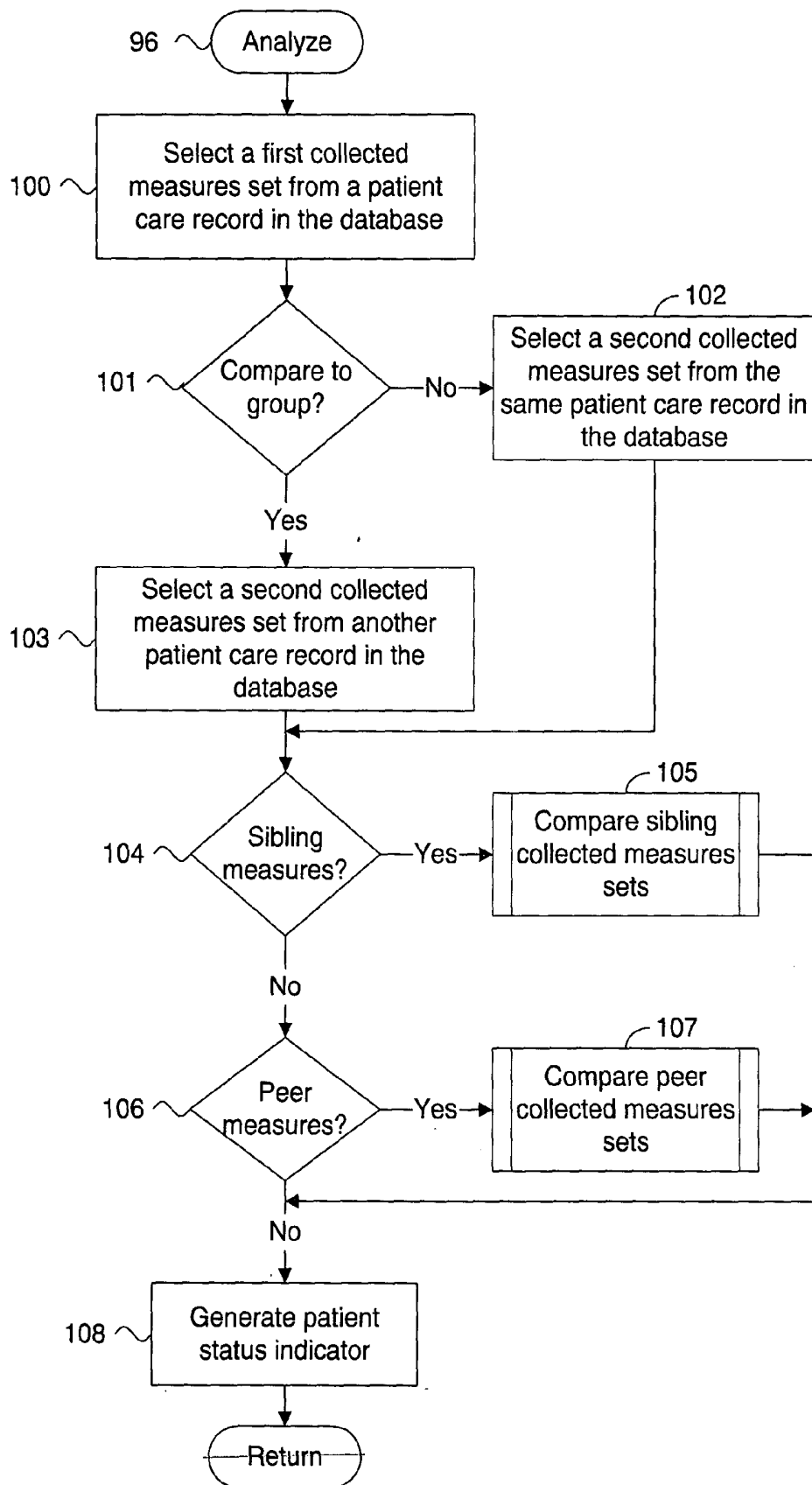

Figure 9.

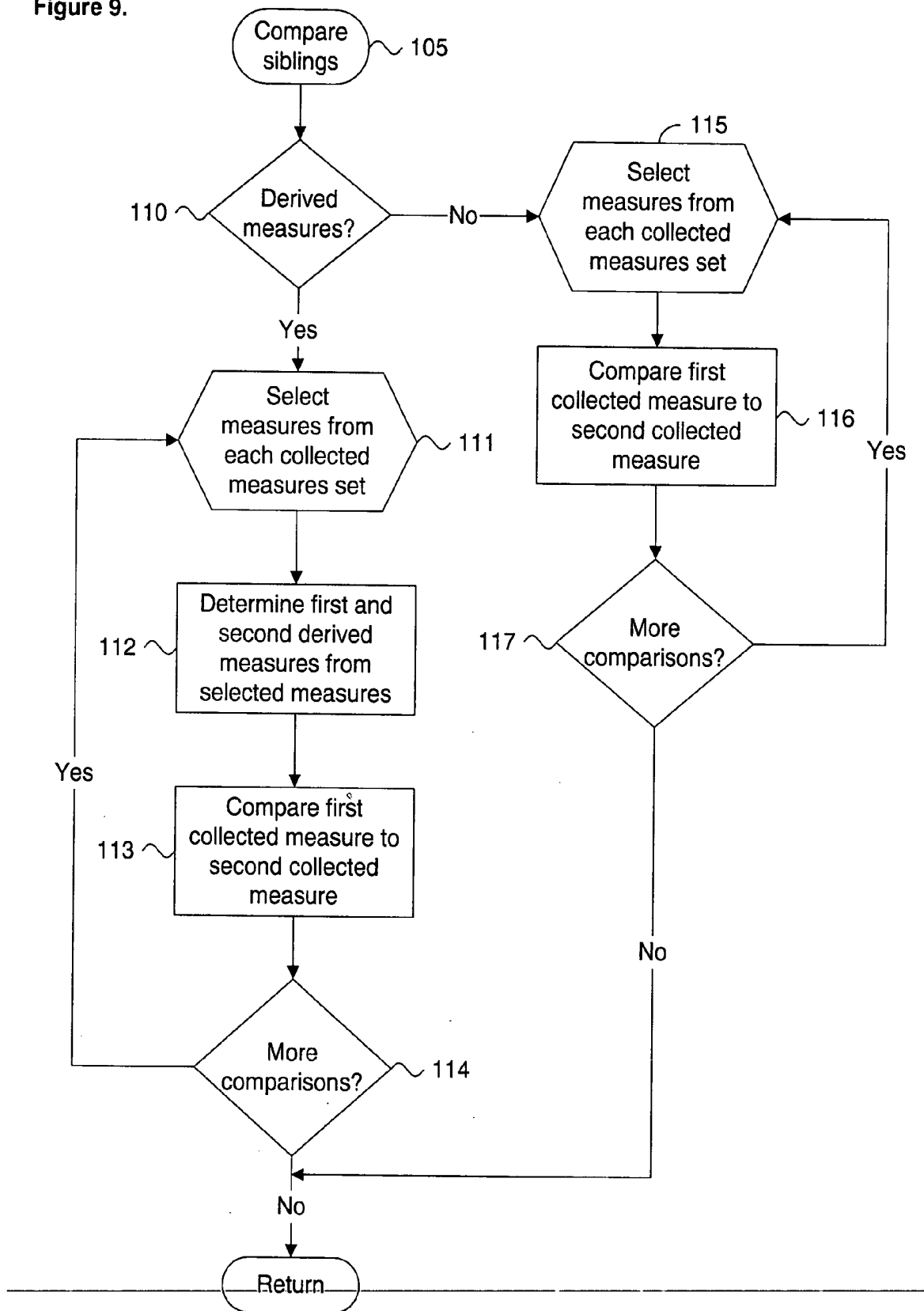

Figure 10A.

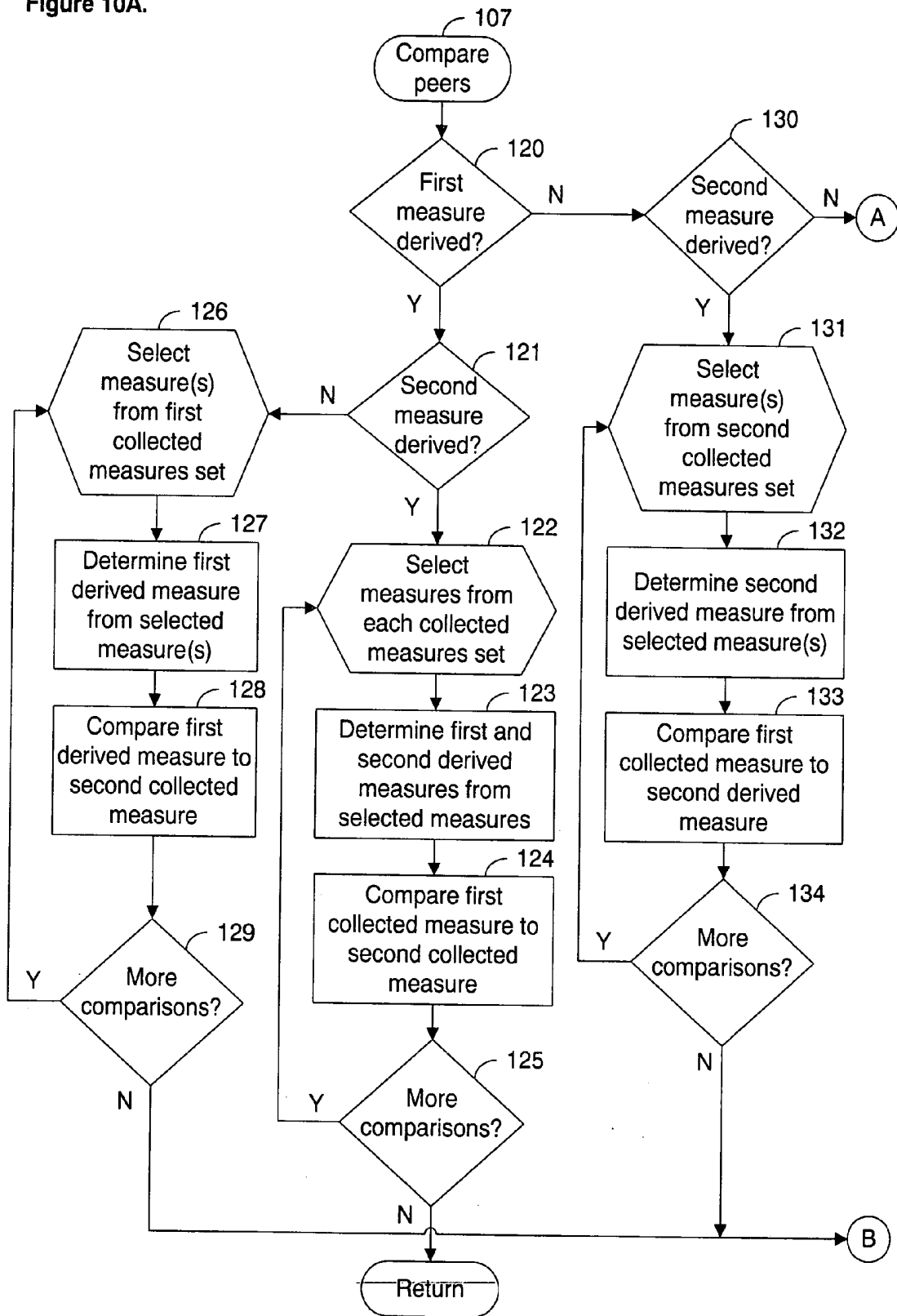

Figure 10B.

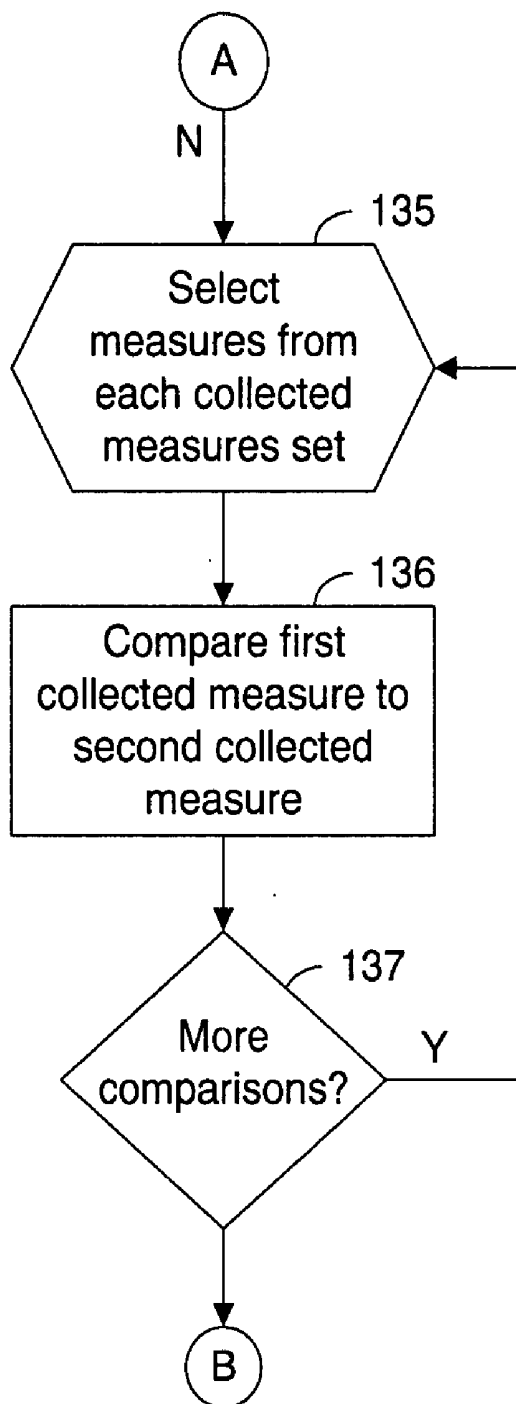
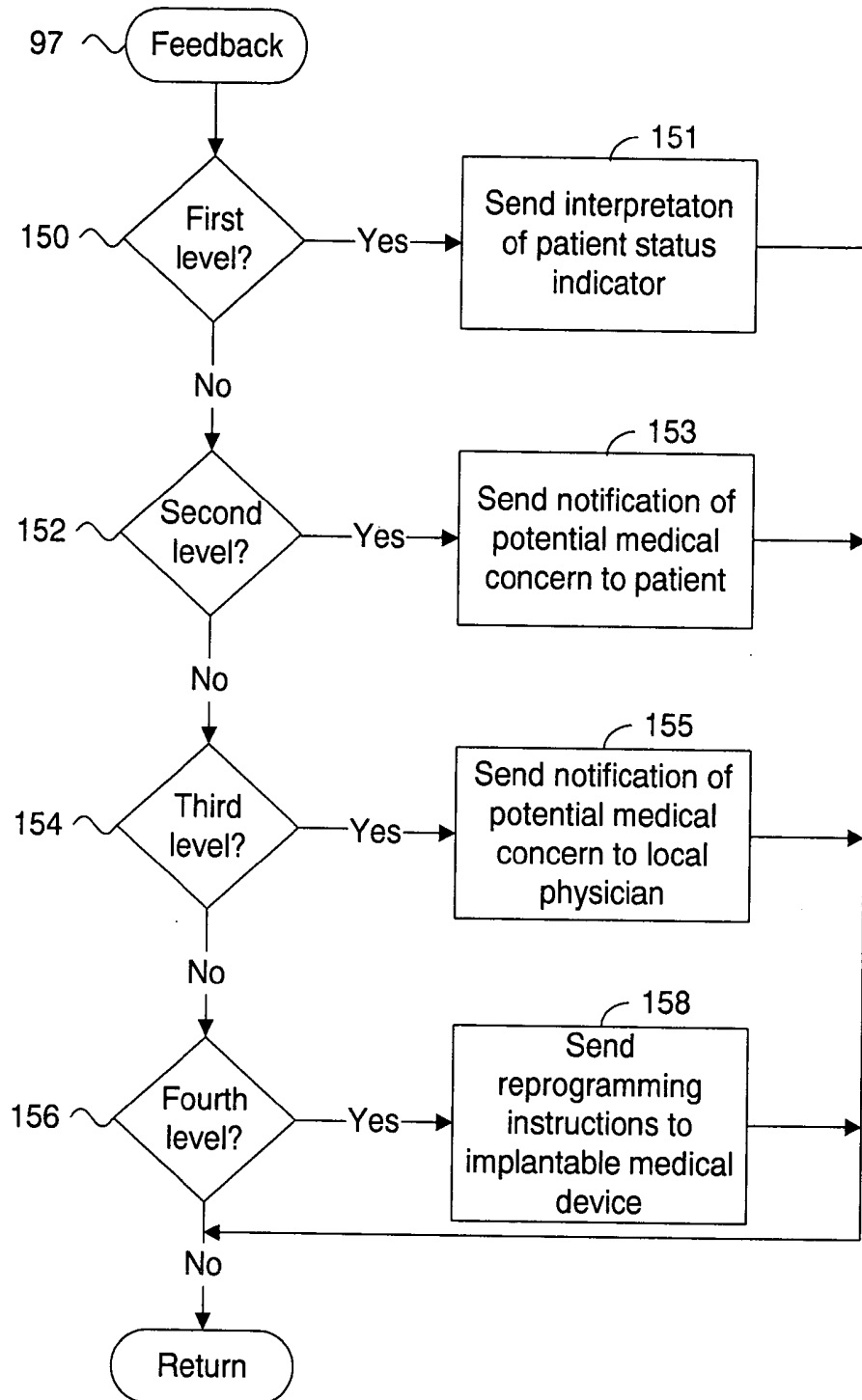

Figure 11.



## SYSTEM AND METHOD FOR COLLECTION AND ANALYSIS OF PATIENT INFORMATION FOR AUTOMATED REMOTE PATIENT CARE

### CROSS-REFERENCE TO RELATED APPLICATION

[0001] This patent application is a continuation of U.S. patent application Ser. No. 09/948,307, filed Sep. 6, 2001, pending; which is a continuation of U.S. Pat. No. 6,312,378, issued Nov. 6, 2001, the disclosures of which are incorporated by reference.

### FIELD OF THE INVENTION

[0002] The present invention relates in general to automated data collection and analysis, and, in particular, to a system and method for automated collection and analysis of patient information retrieved from an implantable medical device for remote patient care.

### BACKGROUND OF THE INVENTION

[0003] Implantable pulse generators (IPGs) are medical devices commonly used to treat irregular heartbeats, known as arrhythmias. There are two basic types. Cardiac pacemakers are used to manage bradycardia, an abnormally slow or irregular heartbeat. Left untreated, bradycardia can cause symptoms such as fatigue, dizziness, and fainting. Implantable cardioverter defibrillators (ICDs) are used to treat tachycardia, heart rhythms that are abnormally fast and life threatening. Tachycardia can result in sudden cardiac death (SCD).

[0004] Pacemakers and ICDs are increasingly being equipped with an on-board, volatile memory in which telemetered signals can be stored for later retrieval and analysis. Typically, the telemetered signals provide patient device information regarding atrial electrical activity, ventricular electrical activity, time of day, activity level, cardiac output, oxygen level, cardiovascular pressure measures, pulmonary measures, and any interventions made on a per heartbeat or binned average basis. In addition, a growing class of cardiac medical devices, including implantable heart failure monitors, implantable event monitors, cardiovascular monitors, and therapy devices, are being used to provide similar stored device information. These devices are able to store approximately thirty minutes of per heartbeat data. Telemetered signals are also stored in a broader class of monitors and therapeutic devices for other areas of medicine, including metabolism, endocrinology, hematology, neurology, muscular, gastrointestinal, genital-urology, ocular, auditory, and the like.

[0005] Presently, stored device information is retrieved using a proprietary interrogator or programmer, often during a clinic visit or following a device event. The volume of data retrieved from a single device interrogation "snapshot" can be large and proper interpretation and analysis can require significant physician time and detailed subspecialty knowledge, particularly by cardiologists and cardiac electrophysiologists. The sequential logging and analysis of regularly scheduled interrogations can create an opportunity for recognizing subtle and incremental changes in patient condition otherwise undetectable by inspection of a single "snapshot." However, present approaches to data interpretation and

understanding and practical limitations on time and physician availability make such analysis impracticable.

[0006] A prior art system for collecting and analyzing pacemaker and ICD telemetered signals in a clinical or office setting is the Model 9790 Programmer, manufactured by Medtronic, Inc., Minneapolis, Minn. This programmer can be used to retrieve data, such as patient electrocardiogram and any measured physiological conditions, collected by the IPG for recordation, display and printing. The retrieved data is displayed in chronological order and analyzed by a physician. Comparable prior art systems are available from other IPG manufacturers, such as the Model 2901 Programmer Recorder Monitor, manufactured by Guidant Corporation, Indianapolis, Ind., which includes a removable floppy diskette mechanism for patient data storage. These prior art systems lack remote communications facilities and must be operated with the patient present. These systems present a limited analysis of the collected data based on a single device interrogation and lack the capability to recognize trends in the data spanning multiple episodes over time or relative to a disease specific peer group.

[0007] A prior art system for locating and communicating with a remote medical device implanted in an ambulatory patient is disclosed in U.S. Pat. No. 5,752,976 ('976). The implanted device includes a telemetry transceiver for communicating data and operating instructions between the implanted device and an external patient communications device. The communications device includes a communication link to a remote medical support network, a global positioning satellite receiver, and a patient activated link for permitting patient initiated communication with the medical support network.

[0008] Related prior art systems for remotely communicating with and receiving telemetered signals from a medical device are disclosed in U.S. Pat. Nos. 5,113,869 ('869) and 5,336,245 ('245). In the '869 patent, an implanted AECG monitor can be automatically interrogated at preset times of day to telemeter out accumulated data to a telephonic communicator or a full disclosure recorder. The communicator can be automatically triggered to establish a telephonic communication link and transmit the accumulated data to an office or clinic through a modem. In the '245 patent, telemetered data is downloaded to a larger capacity, external data recorder and is forwarded to a clinic using an auto-dialer and fax modem operating in a personal computer-based programmer/interrogator. However, the '976 telemetry transceiver, '869 communicator, and '245 programmer/interrogator are limited to facilitating communication and transferal of downloaded patient data and do not include an ability to automatically track, recognize, and analyze trends in the data itself.

[0009] Thus, there is a need for a system and method for providing continuous retrieval, transferal, and automated analysis of retrieved implantable medical device information, such as telemetered signals, retrieved in general from a broad class of implantable medical devices and, in particular, from IPGs and cardiovascular monitors. Preferably, the automated analysis would include recognizing a trend and determining whether medical intervention is necessary.

[0010] There is a further need for a system and method that would allow consideration of sets of collected measures, both actual and derived, from multiple device interrogations.

These collected measures sets could then be compared and analyzed against short and long term periods of observation.

[0011] There is a further need for a system and method that would enable the measures sets for an individual patient to be self-referenced and cross-referenced to similar or dissimilar patients and to the general patient population. Preferably, the historical collected measures sets of an individual patient could be compared and analyzed against those of other patients in general or of a disease specific peer group in particular.

#### SUMMARY OF THE INVENTION

[0012] The present invention provides a system and method for automated collection and analysis of patient information retrieved from an implantable medical device for remote patient care. The patient device information relates to individual measures recorded by and retrieved from implantable medical devices, such as IPGs and monitors. The patient device information is received on a regular, e.g., daily, basis as sets of collected measures which are stored along with other patient records in a database. The information can be analyzed in an automated fashion and feedback provided to the patient at any time and in any location.

[0013] An embodiment of the present invention is a system, method, and computer-readable storage medium holding code for automated collection and analysis of patient information retrieved from a medical device adapted to be implanted in a patient for remote patient care. A set of collected measures is periodically received from the medical device adapted to be implanted over a communications link which is interfaced to a network server. The collected measures set includes individual measures which each relate to patient information recorded by the medical device adapted to be implanted for an individual patient. The collected measures set is stored into a patient care record for the individual patient within a database server organized to store one or more patient care records. Each patient care record includes a plurality of the collected measures sets. One or more of the collected measures sets in the patient care record for the individual patient is analyzed relative to one or more other collected measures sets stored in the database server to determine a patient status indicator. The patient status indicators are then triaged and prioritized for an appropriate level of alert and interaction.

[0014] A further embodiment of the present invention is a system and method for automated remote patient care using patient information retrieved from a medical device adapted to be implanted in a patient. One or more patient care records are organized in a database with each patient care record including a plurality of the collected measures sets. Each collected measures set include individual measures which each relate to patient information recorded by a medical device adapted to be implanted for an individual patient. A set of the collected measures periodically sent from the implantable medical device over a communications link is received. The collected measures set is stored into the patient care record in the database for the individual patient. One or more of the collected measures sets in the patient care record for the individual patient are analyzed relative to one or more other collected measures sets stored in the patient care record of the individual patient. Feedback based

on the analysis of the one or more collected measures sets is sent to the individual patient over a feedback communications link.

[0015] A further embodiment of the present invention is a system and method for automated remote patient care using patient information retrieved from a medical device adapted to be implanted in a patient. A plurality of patient care records is organized in a database with each patient care record including a plurality of the collected measures sets. Each collected measures set includes individual measures which each relate to patient information recorded by a medical device adapted to be implanted for an individual patient. A set of the collected measures periodically sent from the implantable medical device over a communications link is received. The collected measures set is stored into the patient care record in the database for the individual patient. One or more of the collected measures sets in the patient care record for the individual patient is analyzed relative to one or more other collected measures sets stored in other patient care records in the database. Feedback based on the analysis of the one or more collected measures sets is sent to the individual patient over a feedback communications link.

[0016] A further embodiment of the present invention is a system and method for automated remote cardiac patient care using cardiovascular patient information retrieved from a cardiac monitoring device adapted to be implanted in a patient. A set of collected cardiovascular measures recorded by and stored in the cardiac monitoring device adapted to be implanted is retrieved on a substantially regular basis and the collected cardiovascular measures set are periodically communicated over a communications link to a centralized server. The collected cardiovascular measures set is stored into a patient care record for the individual patient in a database coupled to the centralized server. A plurality of patient care records is organized in the database with each patient care record including a plurality of the collected cardiovascular measures sets. Each collected cardiovascular measures set includes individual cardiovascular measures which each relate to patient information recorded by the cardiac monitoring device for an individual patient. One or more of the collected cardiovascular measures sets in the patient care record for the individual patient is analyzed relative to one or more other collected cardiovascular measures sets stored in the patient care records in the database. Feedback based on the analysis of the one or more collected cardiovascular measures sets is sent to the individual patient over a feedback communications link.

[0017] The present invention facilitates the gathering, storage, and analysis of critical patient information obtained on a routine basis and analyzed in an automated manner. Thus, the burden on physicians and trained personnel to evaluate the volumes of information is significantly minimized while the benefits to patients are greatly enhanced.

[0018] Still other embodiments of the present invention will become readily apparent to those skilled in the art from the following description, wherein is described embodiments of the invention by way of illustrating the best mode contemplated for carrying out the invention. As will be realized, the invention is capable of other and different embodiments and its several details are capable of modifications in various obvious respects, all without departing

from the spirit and the scope of the present invention. Accordingly, the drawings and detailed description are to be regarded as illustrative in nature and not as restrictive.

#### BRIEF DESCRIPTION OF THE DRAWINGS

[0019] FIG. 1 is a block diagram showing a system for automated collection and analysis of patient information retrieved from an implantable medical device for remote patient care in accordance with the present invention;

[0020] FIG. 2 is a block diagram showing the hardware components of the server system of the system of FIG. 1;

[0021] FIG. 3 is a block diagram showing the software modules of the server system of the system of FIG. 1;

[0022] FIG. 4 is a block diagram showing the analysis module of the server system of FIG. 3;

[0023] FIG. 5 is a database schema showing, by way of example, the organization of a cardiac patient care record stored in the database of the system of FIG. 1;

[0024] FIG. 6 is a record view showing, by way of example, a set of partial cardiac patient care records stored in the database of the system of FIG. 1;

[0025] FIG. 7 is a flow diagram showing a method for automated collection and analysis of patient information retrieved from an implantable medical device for remote patient care in accordance with the present invention;

[0026] FIG. 8 is a flow diagram showing a routine for analyzing collected measures sets for use in the method of FIG. 7;

[0027] FIG. 9 is a flow diagram showing a routine for comparing sibling collected measures sets for use in the routine of FIG. 8;

[0028] FIGS. 10A and 10B are flow diagrams showing a routine for comparing peer collected measures sets for use in the routine of FIG. 8; and

[0029] FIG. 11 is a flow diagram showing a routine for providing feedback for use in the method of FIG. 7.

#### DETAILED DESCRIPTION

[0030] FIG. 1 is a block diagram showing a system 10 for automated collection and analysis of patient information retrieved from an implantable medical device for remote patient care in accordance with the present invention. A patient 11 is a recipient of an implantable medical device 12, such as, by way of example, an IPG or a heart failure or event monitor, with a set of leads extending into his or her heart. The implantable medical device 12 includes circuitry for recording into a short-term, volatile memory telemetered signals, which are stored as a set of collected measures for later retrieval.

[0031] For an exemplary cardiac implantable medical device, the telemetered signals non-exclusively present patient information relating to: atrial electrical activity, ventricular electrical activity, time of day, activity level, cardiac output, oxygen level, cardiovascular pressure measures, the number and types of interventions made, and the relative success of any interventions made on a per heartbeat or binned average basis, plus the status of the batteries and programmed settings. Examples of pacemakers suitable for

use in the present invention include the Discovery line of pacemakers, manufactured by Guidant Corporation, Indianapolis, Ind. Examples of ICDs suitable for use in the present invention include the Ventak line of ICDs, also manufactured by Guidant Corporation, Indianapolis, Ind.

[0032] In the described embodiment, the patient 11 has a cardiac implantable medical device. However, a wide range of related implantable medical devices are used in other areas of medicine and a growing number of these devices are also capable of measuring and recording patient information for later retrieval. These implantable medical devices include monitoring and therapeutic devices for use in metabolism, endocrinology, hematology, neurology, muscularology, gastro-intestinalogy, genital-urology, ocular, auditory, and similar medical subspecialties. One skilled in the art would readily recognize the applicability of the present invention to these related implantable medical devices.

[0033] On a regular basis, the telemetered signals stored in the implantable medical device 12 are retrieved. By way of example, a programmer 14 can be used to retrieve the telemetered signals. However, any form of programmer, interrogator, recorder, monitor, or telemetered signals transceiver suitable for communicating with an implantable medical device 12 could be used, as is known in the art. In addition, a personal computer or digital data processor could be interfaced to the implantable medical device 12, either directly or via a telemetered signals transceiver configured to communicate with the implantable medical device 12.

[0034] Using the programmer 14, a magnetized reed switch (not shown) within the implantable medical device 12 closes in response to the placement of a wand 13 over the location of the implantable medical device 12. The programmer 14 communicates with the implantable medical device 12 via RF signals exchanged through the wand 14. Programming or interrogating instructions are sent to the implantable medical device 12 and the stored telemetered signals are downloaded into the programmer 14. Once downloaded, the telemetered signals are sent via an internetwork 15, such as the Internet, to a server system 16 which periodically receives and stores the telemetered signals in a database 17, as further described below with reference to FIG. 2.

[0035] An example of a programmer 14 suitable for use in the present invention is the Model 2901 Programmer Recorder Monitor, manufactured by Guidant Corporation, Indianapolis, Ind., which includes the capability to store retrieved telemetered signals on a proprietary removable floppy diskette. The telemetered signals could later be electronically transferred using a personal computer or similar processing device to the internetwork 15, as is known in the art.

[0036] Other alternate telemetered signals transfer means could also be employed. For instance, the stored telemetered signals could be retrieved from the implantable medical device 12 and electronically transferred to the internetwork 15 using the combination of a remote external programmer and analyzer and a remote telephonic communicator, such as described in U.S. Pat. No. 5,113,869, the disclosure of which is incorporated herein by reference. Similarly, the stored telemetered signals could be retrieved and remotely downloaded to the server system 16 using a world-wide patient

location and data telemetry system, such as described in U.S. Pat. No. 5,752,976, the disclosure of which is incorporated herein by reference.

[0037] The received telemetered signals are analyzed by the server system 16, which generates a patient status indicator. The feedback is then provided back to the patient 11 through a variety of means. By way of example, the feedback can be sent as an electronic mail message generated automatically by the server system 16 for transmission over the internetwork 15. The electronic mail message is received by personal computer 18 (PC) situated for local access by the patient 11. Alternatively, the feedback can be sent through a telephone interface device 19 as an automated voice mail message to a telephone 21 or as an automated facsimile message to a facsimile machine 22, both also situated for local access by the patient 11. In addition to a personal computer 18, telephone 21, and facsimile machine 22, feedback could be sent to other related devices, including a network computer, wireless computer, personal data assistant, television, or digital data processor. Preferably, the feedback is provided in a tiered fashion, as further described below with reference to FIG. 3.

[0038] FIG. 2 is a block diagram showing the hardware components of the server system 16 of the system 10 of FIG. 1. The server system 16 consists of three individual servers: network server 31, database server 34, and application server 35. These servers are interconnected via an intranetwork 33. In the described embodiment, the functionality of the server system 16 is distributed among these three servers for efficiency and processing speed, although the functionality could also be performed by a single server or cluster of servers. The network server 31 is the primary interface of the server system 16 onto the internetwork 15. The network server 31 periodically receives the collected telemetered signals sent by remote implantable medical devices over the internetwork 15. The network server 31 is interfaced to the internetwork 15 through a router 32. To ensure reliable data exchange, the network server 31 implements a TCP/IP protocol stack, although other forms of network protocol stacks are suitable.

[0039] The database server 34 organizes the patient care records in the database 17 and provides storage of and access to information held in those records. A high volume of data in the form of collected measures sets from individual patients is received. The database server 34 frees the network server 31 from having to categorize and store the individual collected measures sets in the appropriate patient care record.

[0040] The application server 35 operates management applications and performs data analysis of the patient care records, as further described below with reference to FIG. 3. The application server 35 communicates feedback to the individual patients either through electronic mail sent back over the internetwork 15 via the network server 31 or as automated voice mail or facsimile messages through the telephone interface device 19.

[0041] The server system 16 also includes a plurality of individual workstations 36 (WS) interconnected to the intranetwork 33, some of which can include peripheral devices, such as a printer 37. The workstations 36 are for use by the data management and programming staff, nursing staff, office staff, and other consultants and authorized personnel.

[0042] The database 17 consists of a high-capacity storage medium configured to store individual patient care records and related health care information. Preferably, the database 17 is configured as a set of high-speed, high capacity hard drives, such as organized into a Redundant Array of Inexpensive Disks (RAID) volume. However, any form of volatile storage, non-volatile storage, removable storage, fixed storage, random access storage, sequential access storage, permanent storage, erasable storage, and the like would be equally suitable. The organization of the database 17 is further described below with reference to FIG. 3.

[0043] The individual servers and workstations are general purpose, programmed digital computing devices consisting of a central processing unit (CPU), random access memory (RAM), non-volatile secondary storage, such as a hard drive or CD ROM drive, network interfaces, and peripheral devices, including user interfacing means, such as a keyboard and display. Program code, including software programs, and data are loaded into the RAM for execution and processing by the CPU and results are generated for display, output, transmittal, or storage. In the described embodiment, the individual servers are Intel Pentium-based server systems, such as available from Dell Computers, Austin, Tex., or Compaq Computers, Houston, Tex. Each system is preferably equipped with 128 MB RAM, 100 GB hard drive capacity, data backup facilities, and related hardware for interconnection to the intranetwork 33 and internetwork 15. In addition, the workstations 36 are also Intel Pentium-based personal computer or workstation systems, also available from Dell Computers, Austin, Tex., or Compaq Computers, Houston, Tex. Each workstation is preferably equipped with 64 MB RAM, 10 GB hard drive capacity, and related hardware for interconnection to the intranetwork 33. Other types of server and workstation systems, including personal computers, minicomputers, mainframe computers, supercomputers, parallel computers, workstations, digital data processors and the like would be equally suitable, as is known in the art.

[0044] The telemetered signals are communicated over an internetwork 15, such as the Internet. However, any type of electronic communications link could be used, including an intranetwork link, serial link, data telephone link, satellite link, radio-frequency link, infrared link, fiber optic link, coaxial cable link, television link, and the like, as is known in the art. Also, the network server 31 is interfaced to the internetwork 15 using a T-1 network router 32, such as manufactured by Cisco Systems, Inc., San Jose, Calif. However, any type of interfacing device suitable for interconnecting a server to a network could be used, including a data modem, cable modem, network interface, serial connection, data port, hub, frame relay, digital PBX, and the like, as is known in the art.

[0045] FIG. 3 is a block diagram showing the software modules of the server system 16 of the system 10 of FIG. 1. Each module is a computer program written as source code in a conventional programming language, such as the C or Java programming languages, and is presented for execution by the CPU as object byte code, as is known in the arts. The various implementations of the source code and object and byte codes can be held on a computer-readable storage medium or embodied on a transmission medium in a carrier wave. There are three basic software modules, which functionally define the primary operations performed

by the server system 16: database module 51, analysis module 53, and feedback module 55. In the described embodiment, these modules are executed in a distributed computing environment, although a single server or a cluster of servers could also perform the functionality of the modules. The module functions are further described below in more detail beginning with reference to FIG. 7.

[0046] For each patient being provided remote patient care, the server system 16 periodically receives a collected measures set 50 which is forwarded to the database module 51 for processing. The database module 51 organizes the individual patient care records stored in the database 52 and provides the facilities for efficiently storing and accessing the collected measures sets 50 and patient data maintained in those records. An exemplary database schema for use in storing collected measures sets 50 in a patient care record is described below, by way of example, with reference to FIG. 5. The database server 34 (shown in FIG. 2) performs the functionality of the database module 51. Any type of database organization could be utilized, including a flat file system, hierarchical database, relational database, or distributed database, such as provided by database vendors, such as Oracle Corporation, Redwood Shores, Calif.

[0047] The analysis module 53 analyzes the collected measures sets 50 stored in the patient care records in the database 52. The analysis module 53 makes an automated determination of patient wellness in the form of a patient status indicator 54. Collected measures sets 50 are periodically received from implantable medical devices and maintained by the database module 51 in the database 52. Through the use of this collected information, the analysis module 53 can continuously follow the medical well being of a patient and can recognize any trends in the collected information that might warrant medical intervention. The analysis module 53 compares individual measures and derived measures obtained from both the care records for the individual patient and the care records for a disease specific group of patients or the patient population in general. The analytic operations performed by the analysis module 53 are further described below with reference to FIG. 4. The application server 35 (shown in FIG. 2) performs the functionality of the analysis module 53.

[0048] The feedback module 55 provides automated feedback to the individual patient based, in part, on the patient status indicator 54. As described above, the feedback could be by electronic mail or by automated voice mail or facsimile. Preferably, the feedback is provided in a tiered manner. In the described embodiment, four levels of automated feedback are provided. At a first level, an interpretation of the patient status indicator 54 is provided. At a second level, a notification of potential medical concern based on the patient status indicator 54 is provided. This feedback level could also be coupled with human contact by specially trained technicians or medical personnel. At a third level, the notification of potential medical concern is forwarded to medical practitioners located in the patient's geographic area. Finally, at a fourth level, a set of reprogramming instructions based on the patient status indicator 54 could be transmitted directly to the implantable medical device to modify the programming instructions contained therein. As is customary in the medical arts, the basic tiered feedback scheme would be modified in the event of bona fide medical

emergency. The application server 35 (shown in FIG. 2) performs the functionality of the feedback module 55.

[0049] FIG. 4 is a block diagram showing the analysis module 53 of the server system 16 of FIG. 3. The analysis module 53 contains two functional submodules: comparison module 62 and derivation module 63. The purpose of the comparison module 62 is to compare two or more individual measures, either collected or derived. The purpose of the derivation module 63 is to determine a derived measure based on one or more collected measures which is then used by the comparison module 62. For instance, a new and improved indicator of impending heart failure could be derived based on the exemplary cardiac collected measures set described with reference to FIG. 5. The analysis module 53 can operate either in a batch mode of operation wherein patient status indicators are generated for a set of individual patients or in a dynamic mode wherein a patient status indicator is generated on the fly for an individual patient.

[0050] The comparison module 62 receives as inputs from the database 17 two input sets functionally defined as peer collected measures sets 60 and sibling collected measures sets 61, although in practice, the collected measures sets are stored on a per sampling basis. Peer collected measures sets 60 contain individual collected measures sets that all relate to the same type of patient information, for instance, atrial electrical activity, but which have been periodically collected over time. Sibling collected measures sets 61 contain individual collected measures sets that relate to different types of patient information, but which may have been collected at the same time or different times. In practice, the collected measures sets are not separately stored as "peer" and "sibling" measures. Rather, each individual patient care record stores multiple sets of sibling collected measures. The distinction between peer collected measures sets 60 and sibling collected measures sets 61 is further described below with reference to FIG. 6.

[0051] The derivation module 63 determines derived measures sets 64 on an as-needed basis in response to requests from the comparison module 62. The derived measures 64 are determined by performing linear and non-linear mathematical operations on selected peer measures 60 and sibling measures 61, as is known in the art.

[0052] FIG. 5 is a database schema showing, by way of example, the organization of a cardiac patient care record stored 70 in the database 17 of the system 10 of FIG. 1. Only the information pertaining to collected measures sets are shown. Each patient care record would also contain normal identifying and treatment profile information, as well as medical history and other pertinent data (not shown). Each patient care record stores a multitude of collected measures sets for an individual patient. Each individual set represents a recorded snapshot of telemetered signals data which was recorded, for instance, per heartbeat or binned average basis by the implantable medical device 12. For example, for a cardiac patient, the following information would be recorded as a collected measures set: atrial electrical activity 71, ventricular electrical activity 72, time of day 73, activity level 74, cardiac output 75, oxygen level 76, cardiovascular pressure measures 77, pulmonary measures 78, interventions made by the implantable medical device 78, and the relative success of any interventions made 80. In addition, the implantable medical device 12 would also communicate

device specific information, including battery status **81** and program settings **82**. Other types of collected measures are possible. In addition, a well-documented set of derived measures can be determined based on the collected measures, as is known in the art.

**[0053]** FIG. 6 is a record view showing, by way of example, a set of partial cardiac patient care records stored in the database **17** of the system **10** of FIG. 1. Three patient care records are shown for Patient 1, Patient 2, and Patient 3. For each patient, three sets of measures are shown, X, Y, and Z. The measures are organized into sets with Set 0 representing sibling measures made at a reference time  $t=0$ . Similarly, Set  $n-2$ , Set  $n-1$  and Set  $n$  each represent sibling measures made at later reference times  $t=n-2$ ,  $t=n-1$  and  $t=n$ , respectively.

**[0054]** For a given patient, for instance, Patient 1, all measures representing the same type of patient information, such as measure X, are peer measures. These are measures, which are monitored over time in a disease-matched peer group. All measures representing different types of patient information, such as measures X, Y, and Z, are sibling measures. These are measures which are also measured over time, but which might have medically significant meaning when compared to each other within a single set. Each of the measures, X, Y, and Z, could be either collected or derived measures.

**[0055]** The analysis module **53** (shown in FIG. 4) performs two basic forms of comparison. First, individual measures for a given patient can be compared to other individual measures for that same patient. These comparisons might be peer-to-peer measures projected over time, for instance,  $X_n, X_{n-1}, X_{n-2}, \dots, X_0$ , or sibling-to-sibling measures for a single snapshot, for instance,  $X_n, Y_n$ , and  $Z_n$ , or projected over time, for instance,  $X_n, Y_n, Z_n, X_{n-1}, Y_{n-1}, Z_{n-1}, X_{n-2}, Y_{n-2}, Z_{n-2}, \dots, X_0, Y_0, Z_0$ . Second, individual measures for a given patient can be compared to other individual measures for a group of other patients sharing the same disease-specific characteristics or to the patient population in general. Again, these comparisons might be peer-to-peer measures projected over time, for instance,  $X_n, X_n, X_n, X_{n-1}, X_{n-1}, X_{n-1}, X_{n-2}, X_{n-2}, X_{n-2}, \dots, X_0, X_0, X_0$ , or comparing the individual patient's measures to an average from the group. Similarly, these comparisons might be sibling-to-sibling measures for single snapshots, for instance,  $X_n, X_n, X_n, Y_n, Y_n, Y_n$ , and  $Z_n, Z_n, Z_n$ , or projected over time, for instance,  $X_n, X_n, X_n, Y_n, Y_n, Y_n, Z_n, Z_n, Z_n, X_{n-1}, X_{n-1}, X_{n-1}, Y_{n-1}, Y_{n-1}, Y_{n-1}, Z_{n-1}, Z_{n-1}, Z_{n-1}, X_{n-2}, X_{n-2}, X_{n-2}, Y_{n-2}, Y_{n-2}, Y_{n-2}, Z_{n-2}, Z_{n-2}, Z_{n-2}, \dots, X_0, X_0, X_0, Y_0, Y_0, Y_0$ , and  $Z_0, Z_0, Z_0$ . Other forms of comparisons are feasible.

**[0056]** FIG. 7 is a flow diagram showing a method **90** for automated collection and analysis of patient information retrieved from an implantable medical device **12** for remote patient care in accordance with the present invention. The method **90** is implemented as a conventional computer program for execution by the server system **16** (shown in FIG. 1). As a preparatory step, the patient care records are organized in the database **17** with a unique patient care record assigned to each individual patient (block **91**). Next, the collected measures sets for an individual patient are retrieved from the implantable medical device **12** (block **92**) using a programmer, interrogator, telemetered signals trans-

ceiver, and the like. The retrieved collected measures sets are sent, on a substantially regular basis, over the internetwork **15** or similar communications link (block **93**) and periodically received by the server system **16** (block **94**). The collected measures sets are stored into the patient care record in the database **17** for that individual patient (block **95**). One or more of the collected measures sets for that patient are analyzed (block **96**), as further described below with reference to FIG. 8. Finally, feedback based on the analysis is sent to that patient over the internetwork **15** as an email message, via telephone line as an automated voice mail or facsimile message, or by similar feedback communications link (block **97**), as further described below with reference to FIG. 11.

**[0057]** FIG. 8 is a flow diagram showing the routine for analyzing collected measures sets **96** for use in the method of FIG. 7. The purpose of this routine is to make a determination of general patient wellness based on comparisons and heuristic trends analyses of the measures, both collected and derived, in the patient care records in the database **17**. A first collected measures set is selected from a patient care record in the database **17** (block **100**). If the measures comparison is to be made to other measures originating from the patient care record for the same individual patient (block **101**), a second collected measures set is selected from that patient care record (block **102**). Otherwise, a group measures comparison is being made (block **101**) and a second collected measures set is selected from another patient care record in the database **17** (block **103**). Note the second collected measures set could also contain averaged measures for a group of disease specific patients or for the patient population in general.

**[0058]** Next, if a sibling measures comparison is to be made (block **104**), a routine for comparing sibling collected measures sets is performed (block **105**), as further described below with reference to FIG. 9. Similarly, if a peer measures comparison is to be made (block **106**), a routine for comparing sibling collected measures sets is performed (block **107**), as further described below with reference to FIGS. **10A** and **10B**.

**[0059]** Finally, a patient status indicator is generated (block **108**). By way of example, cardiac output could ordinarily be approximately 5.0 liters per minute with a standard deviation of  $\pm 1.0$ . An actionable medical phenomenon could occur when the cardiac output of a patient is  $\pm 3.0$ - $4.0$  standard deviations out of the norm. A comparison of the cardiac output measures **75** (shown in FIG. 5) for an individual patient against previous cardiac output measures **75** would establish the presence of any type of downward health trend as to the particular patient. A comparison of the cardiac output measures **75** of the particular patient to the cardiac output measures **75** of a group of patients would establish whether the patient is trending out of the norm. From this type of analysis, the analysis module **53** generates a patient status indicator **54** and other metrics of patient wellness, as is known in the art.

**[0060]** FIG. 9 is a flow diagram showing the routine for comparing sibling collected measures sets **105** for use in the routine of FIG. 8. Sibling measures originate from the patient care records for an individual patient. The purpose of this routine is either to compare sibling derived measures to sibling derived measures (blocks **111-113**) or sibling col-

lected measures to sibling collected measures (blocks 115-117). Thus, if derived measures are being compared (block 110), measures are selected from each collected measures set (block 111). First and second derived measures are derived from the selected measures (block 112) using the derivation module 63 (shown in FIG. 4). The first and second derived measures are then compared (block 113) using the comparison module 62 (also shown in FIG. 4). The steps of selecting, determining, and comparing (blocks 111-113) are repeated until no further comparisons are required (block 114), whereupon the routine returns.

[0061] If collected measures are being compared (block 110), measures are selected from each collected measures set (block 115). The first and second collected measures are then compared (block 116) using the comparison module 62 (also shown in FIG. 4). The steps of selecting and comparing (blocks 115-116) are repeated until no further comparisons are required (block 117), whereupon the routine returns.

[0062] FIGS. 10A and 10B are a flow diagram showing the routine for comparing peer collected measures sets 107 for use in the routine of FIG. 8. Peer measures originate from patient care records for different patients, including groups of disease specific patients or the patient population in general. The purpose of this routine is to compare peer derived measures to peer derived measures (blocks 122-125), peer derived measures to peer collected measures (blocks 126-129), peer collected measures to peer derived measures (block 131-134), or peer collected measures to peer collected measures (blocks 135-137). Thus, if the first measure being compared is a derived measure (block 120) and the second measure being compared is also a derived measure (block 121), measures are selected from each collected measures set (block 122). First and second derived measures are derived from the selected measures (block 123) using the derivation module 63 (shown in FIG. 4). The first and second derived measures are then compared (block 124) using the comparison module 62 (also shown in FIG. 4). The steps of selecting, determining, and comparing (blocks 122-124) are repeated until no further comparisons are required (block 115), whereupon the routine returns.

[0063] If the first measure being compared is a derived measure (block 120) but the second measure being compared is a collected measure (block 121), a first measure is selected from the first collected measures set (block 126). A first derived measure is derived from the first selected measure (block 127) using the derivation module 63 (shown in FIG. 4). The first derived and second collected measures are then compared (block 128) using the comparison module 62 (also shown in FIG. 4). The steps of selecting, determining, and comparing (blocks 126-128) are repeated until no further comparisons are required (block 129), whereupon the routine returns.

[0064] If the first measure being compared is a collected measure (block 120) but the second measure being compared is a derived measure (block 130), a second measure is selected from the second collected measures set (block 131). A second derived measure is derived from the second selected measure (block 132) using the derivation module 63 (shown in FIG. 4). The first collected and second derived measures are then compared (block 133) using the comparison module 62 (also shown in FIG. 4). The steps of selecting, determining, and comparing (blocks 131-133) are

repeated until no further comparisons are required (block 134), whereupon the routine returns.

[0065] If the first measure being compared is a collected measure (block 120) and the second measure being compared is also a collected measure (block 130), measures are selected from each collected measures set (block 135). The first and second collected measures are then compared (block 136) using the comparison module 62 (also shown in FIG. 4). The steps of selecting and comparing (blocks 135-136) are repeated until no further comparisons are required (block 137), whereupon the routine returns.

[0066] FIG. 11 is a flow diagram showing the routine for providing feedback 97 for use in the method of FIG. 7. The purpose of this routine is to provide tiered feedback based on the patient status indicator. Four levels of feedback are provided with increasing levels of patient involvement and medical care intervention. At a first level (block 150), an interpretation of the patient status indicator 54, preferably phrased in lay terminology, and related health care information is sent to the individual patient (block 151) using the feedback module 55 (shown in FIG. 3). At a second level (block 152), a notification of potential medical concern, based on the analysis and heuristic trends analysis, is sent to the individual patient (block 153) using the feedback module 55. At a third level (block 154), the notification of potential medical concern is forwarded to the physician responsible for the individual patient or similar health care professionals (block 155) using the feedback module 55. Finally, at a fourth level (block 156), reprogramming instructions are sent to the implantable medical device 12 (block 157) using the feedback module 55.

[0067] Therefore, through the use of the collected measures sets, the present invention makes possible immediate access to expert medical care at any time and in any place. For example, after establishing and registering for each patient an appropriate baseline set of measures, the database server could contain a virtually up-to-date patient history, which is available to medical providers for the remote diagnosis and prevention of serious illness regardless of the relative location of the patient or time of day.

[0068] Moreover, the gathering and storage of multiple sets of critical patient information obtained on a routine basis makes possible treatment methodologies based on an algorithmic analysis of the collected data sets. Each successive introduction of a new collected measures set into the database server would help to continually improve the accuracy and effectiveness of the algorithms used. In addition, the present invention potentially enables the detection, prevention, and cure of previously unknown forms of disorders based on a trends analysis and by a cross-referencing approach to create continuously improving peer-group reference databases.

[0069] Finally, the present invention makes possible the provision of tiered patient feedback based on the automated analysis of the collected measures sets. This type of feedback system is suitable for use in, for example, a subscription based health care service. At a basic level, informational feedback can be provided by way of a simple interpretation of the collected data. The feedback could be built up to provide a graduated response to the patient, for example, to notify the patient that he or she is trending into a potential trouble zone. Human interaction could be introduced, both

by remotely situated and local medical practitioners. Finally, the feedback could include direct interventive measures, such as remotely reprogramming a patient's IPG.

[0070] While the invention has been particularly shown and described as referenced to the embodiments thereof, those skilled in the art will understand that the foregoing and other changes in form and detail may be made therein without departing from the spirit and scope of the invention.

What is claimed is:

1. A system for collection and analysis of patient information for automated remote patient care, comprising:

- a medical device adapted to be implanted for an individual patient regularly recording and storing measures sets comprising individual measures which each relate to patient information;
- a database collecting one or more patient care records, organizing one or more patient care records which each comprise a plurality of the collected measures sets, and storing the collected measures set into a patient care record for the individual patient within a database; and
- a server periodically receiving a set of the collected measures from the medical device adapted to be implanted, and analyzing one or more of the collected measures sets in the patient care record for the individual patient relative to one or more other collected measures sets stored in the database server to determine a patient status indicator.

2. A system according to Claim 1, the server further comprising:

- a comparison module comparing an initial measure selected from the one or more collected measures sets to a sibling measure selected from the one or more other collected measures sets, the initial measure and the sibling measure both relating to the same type of patient information.

3. A system according to Claim 1, the server further comprising:

- a derivation module determining an initial derived measure using at least one measure selected from the one or more collected measures sets and determining a sibling derived measure using at least one measure selected from the one or more other collected measures sets, the initial derived measure and the sibling derived measure both relating to the same type of derived patient information; and
- a comparison module comparing the initial derived measure to the sibling derived measure.

4. A system according to Claim 1, the server further comprising:

- a comparison module comparing an initial measure selected from the one or more collected measures sets to a peer measure selected from the one or more other collected measures sets, the initial measure relating to a different type of patient information than the peer measure.

5. A system according to Claim 1, the server further comprising:

- a derivation module determining a peer derived measure using at least one measure selected from the one or more other collected measures sets; and
- a comparison module comparing an initial measure selected from the one or more collected measures sets to the peer derived measure, the initial measure relating to a different type of patient information than the derived patient information to which the peer derived measure relates.

6. A system according to Claim 1, the server further comprising:

- a derivation module determining an initial derived measure using at least one measure selected from the one or more collected measures sets; and
- a comparison module comparing the initial derived measure to a peer measure selected from the one or more other collected measures sets, the initial derived measure relating to a different type of derived patient information than the patient information to which the peer measure relates.

7. A system according to Claim 1, the server further comprising:

- a derivation module determining an initial derived measure using at least one measure selected from the one or more collected measures sets and determining a peer derived measure using at least one measure selected from the one or more other collected measures sets; and
- a comparison module comparing the initial derived measure to the peer derived measure, the initial derived measure relating to a different type of derived patient information than the derived patient information to which the peer derived measure relates.

8. A system according to Claim 1, wherein the one or more other collected measures sets are stored in the patient care record for the individual patient for whom the patient care indicator has been determined.

9. A system according to Claim 1, wherein the one or more other collected measures sets are stored in the patient care records for a group of one or more other individual patients.

10. A system according to Claim 1, further comprising:

- a collection client communicatively interposed between the medical device adapted to be implanted and the communications link, the collection client retrieving the collected measures set and downloading the collected measures set from the collection client into the network server over the communications link.

11. A system according to Claim 10, wherein the collection client is selected from the group consisting of a programmer, interrogator, recorder, monitor, telemetered signals transceiver, personal computer, digital data processor, and combinations thereof.

12. A system according to Claim 1, the server being interfaced to a feedback communications link and further comprising:

- a feedback client interfaced to the feedback communications link over which automated feedback based on the patient status indicator is provided to the individual patient from the server.

13. A system according to Claim 12, the server further comprising:

a feedback module providing tiered feedback comprising:

at a first level of feedback, communicating an interpretation of the patient status indicator to the individual patient;

at a second level of feedback, communicating a notification of potential medical concern based on the patient status indicator to the individual patient;

at a third level of feedback, communicating a notification of potential medical concern based on the patient status indicator to medical personnel in local proximity to the individual patient; and

at a fourth level of feedback, communicating a set of reprogramming instructions based on the patient status indicator to the implantable medical device.

14. A system according to Claim 12, wherein the automated feedback comprises at least one of the group consisting of a peer group status indicator, a historical status indicator, a trend indicator, a medicinal efficacy indicator, and a wellness indicator.

15. A system according to Claim 12, wherein the feedback communications link comprises at least one of the following: internetwork link, intranetwork link, serial link, data telephone link, satellite link, radio-frequency link, infrared link, fiber optic link, coaxial cable link, television link, and combinations thereof.

16. A system according to Claim 12, wherein the feedback client is selected from the group consisting of a personal computer, facsimile machine, telephone instrument, network computer, wireless computer, personal data assistant, television, digital data processor, and combinations thereof.

17. A system according to Claim 1, the server further comprising:

an analysis module dynamically analyzing the one or more of the collected measures sets in the patient care record for the individual patient.

18. A system according to Claim 1, the server further comprising:

an analysis module analyzing the one or more of the collected measures sets in the patient care record for the individual patient in a batch comprising the one or more of the collected measures sets in patient care records for a plurality of individual patients.

19. A system according to Claim 1, wherein the communications link comprises at least one of the following: internetwork link, intranetwork link, serial link, data telephone link, satellite link, radio-frequency link, infrared link, fiber optic link, coaxial cable link, television link, and combinations thereof.

20. A system according to Claim 1, wherein the database comprises at least one of the following: volatile storage, non-volatile storage, removable storage, fixed storage, random access storage, sequential access storage, permanent storage, erasable storage, and combinations thereof.

21. A system according to Claim 1, wherein the organization of the database comprises at least one of the following: flat file, hierarchical database server, relational database server, distributed database server, and combinations thereof.

22. A system according to Claim 1, wherein the server is selected from the group consisting of a personal computer, minicomputer, mainframe computer, supercomputer, parallel computer, workstation, digital data processor, and combinations thereof.

23. A system according to Claim 1, wherein the medical device is selected from the group consisting of a pacemaker, implantable cardioverter defibrillator, implantable heart failure monitor, implantable event monitor, implantable cardiopulmonary monitor, implantable metabolic monitor or device, endocrinology monitor or device, hematology monitor or device, implantable neuromuscular monitor or device, implantable gastrointestinal monitor or device, genitourinary monitor or device, and combinations thereof.

24. A system according to Claim 1, wherein the set of collected measures comprises at least one of the following: atrial electrical activity, ventricular electrical activity, time of day, activity level, cardiac output, oxygen level, cardiovascular pressure measures, pulmonary measures, interventions made, and combinations thereof.

25. A system according to Claim 24, the set of collected measures further comprising derived measures selected from the group consisting of linear measures derived from the set of collected measures, non-linear measures derived from the set of collected measures, and combinations thereof.

26. A method for collection and analysis of patient information for automated remote patient care, comprising:

regularly recording and storing measures sets comprising individual measures which each relate to patient information by a medical device adapted to be implanted for an individual patient;

periodically receiving a set of the collected measures from the medical device adapted to be implanted;

collecting one or more patient care records into a database, comprising:

organizing one or more patient care records which each comprise a plurality of the collected measures sets;

storing the collected measures set into a patient care record for the individual patient within the database; and

analyzing one or more of the collected measures sets in the patient care record for the individual patient relative to one or more other collected measures sets stored in the database to determine a patient status indicator.

27. A method according to claim 26, the operation of analyzing the one or more collected measures sets further comprising:

comparing an initial measure selected from the one or more collected measures sets to a sibling measure selected from the one or more other collected measures sets, the initial measure and the sibling measure both relating to the same type of patient information.

28. A method according to Claim 26, the operation of analyzing the one or more collected measures sets further comprising:

determining an initial derived measure using at least one measure selected from the one or more collected measures sets;

- determining a sibling derived measure using at least one measure selected from the one or more other collected measures sets, the initial derived measure and the sibling derived measure both relating to the same type of derived patient information; and
- comparing the initial derived measure to the sibling derived measure.
- 29.** A method according to Claim 26, the operation of analyzing the one or more collected measures sets further comprising:
- comparing an initial measure selected from the one or more collected measures sets to a peer measure selected from the one or more other collected measures sets, the initial measure relating to a different type of patient information than the peer measure.
- 30.** A method according to Claim 26, the operation of analyzing the one or more collected measures sets further comprising:
- determining a peer derived measure using at least one measure selected from the one or more other collected measures sets; and
- comparing an initial measure selected from the one or more collected measures sets to the peer derived measure, the initial measure relating to a different type of patient information than the derived patient information to which the peer derived measure relates.
- 31.** A method according to Claim 26, the operation of analyzing the one or more collected measures sets further comprising:
- determining an initial derived measure using at least one measure selected from the one or more collected measures sets; and
- comparing the initial derived measure to a peer measure selected from the one or more other collected measures sets, the initial derived measure relating to a different type of derived patient information than the patient information to which the peer measure relates.
- 32.** A method according to Claim 26, the operation of analyzing the one or more collected measures sets further comprising:
- determining an initial derived measure using at least one measure selected from the one or more collected measures sets;
- determining a peer derived measure using at least one measure selected from the one or more other collected measures sets; and
- comparing the initial derived measure to the peer derived measure, the initial derived measure relating to a different type of derived patient information than the derived patient information to which the peer derived measure relates.
- 33.** A method according to Claim 26, wherein the one or more other collected measures sets are stored in the patient care record for the individual patient for whom the patient care indicator has been determined.
- 34.** A method according to Claim 26, wherein the one or more other collected measures sets are stored in the patient care records for a group of one or more other individual patients.
- 35.** A method according to Claim 26, further comprising:
- retrieving the collected measures set into a collection client communicatively interposed between the medical device adapted to be implanted and a network server; and
- downloading the collected measures set from the collection client into the network server.
- 36.** A method according to Claim 35, wherein the collection client is selected from the group consisting of a programmer, interrogator, recorder, monitor, telemetered signals transceiver, personal computer, digital data processor, and combinations thereof.
- 37.** A method according to Claim 26, further comprising:
- providing automated feedback based on the patient status indicator to the individual patient configured between a network server and a feedback client.
- 38.** A method according to Claim 37, further comprising:
- providing tiered feedback comprising:
- at a first level of feedback, communicating an interpretation of the patient status indicator to the individual patient;
  - at a second level of feedback, communicating a notification of potential medical concern based on the patient status indicator to the individual patient;
  - at a third level of feedback, communicating a notification of potential medical concern based on the patient status indicator to medical personnel in local proximity to the individual patient; and
  - at a fourth level of feedback, communicating a set of reprogramming instructions based on the patient status indicator to the implantable medical device.
- 39.** A method according to Claim 37, wherein the automated feedback comprises at least one of the group consisting of a peer group status indicator, a historical status indicator, a trend indicator, a medicinal efficacy indicator, and a wellness indicator.
- 40.** A method according to Claim 37, wherein a feedback communications link comprises at least one of the following: internetwork link, intranetwork link, serial link, data telephone link, satellite link, radio-frequency link, infrared link, fiber optic link, coaxial cable link, television link, and combinations thereof.
- 41.** A method according to Claim 37, wherein the feedback client is selected from the group consisting of a personal computer, facsimile machine, telephone instrument, network computer, wireless computer, personal data assistant, television, digital data processor, and combinations thereof.
- 42.** A method according to Claim 26, further comprising:
- dynamically analyzing the one or more of the collected measures sets in the patient care record for the individual patient.
- 43.** A method according to Claim 26, further comprising:
- analyzing the one or more of the collected measures sets in the patient care record for the individual patient in a batch comprising the one or more of the collected measures sets in patient care records for a plurality of individual patients.

**44.** A method according to Claim 26, wherein a communications link comprises at least one of the following: internetwork link, intranetwork link, serial link, data telephone link, satellite link, radio-frequency link, infrared link, fiber optic link, coaxial cable link, television link, and combinations thereof.

**45.** A method according to Claim 26, wherein the database comprises at least one of the following: volatile storage, non-volatile storage, removable storage, fixed storage, random access storage, sequential access storage, permanent storage, erasable storage, and combinations thereof.

**46.** A method according to Claim 45, wherein an organization of the database comprises at least one of the following: flat file, hierarchical database server, relational database server, distributed database server, and combinations thereof.

**47.** A method according to Claim 26, wherein a server is selected from the group consisting of a personal computer, minicomputer, mainframe computer, supercomputer, parallel computer, workstation, digital data processor, and combinations thereof.

**48.** A method according to Claim 26, wherein the medical device is selected from the group consisting of a pacemaker, implantable cardioverter defibrillator, implantable heart failure monitor, implantable event monitor, implantable cardiopulmonary monitor, implantable metabolic monitor or device, endocrinology monitor or device, hematological monitor or device, implantable neuromuscular monitor or device, implantable gastrointestinal monitor or device, genitourinary monitor or device, and combinations thereof.

**49.** A method according to Claim 26, wherein the set of collected measures comprises at least one of the following: atrial electrical activity, ventricular electrical activity, time of day, activity level, cardiac output, oxygen level, cardiovascular pressure measures, pulmonary measures, interventions made, and combinations thereof.

**50.** A method according to Claim 49, the set of collected measures further comprising derived measures selected from the group consisting of linear measures derived from the set of collected measures, non-linear measures derived from the set of collected measures, and combinations thereof.

**51.** A computer-readable storage medium holding code for collection and analysis of patient information for automated remote patient care, comprising:

code for regularly recording and storing measures sets comprising individual measures which each relate to patient information by a medical device adapted to be implanted for an individual patient;

code for periodically receiving a set of the collected measures from the medical device adapted to be implanted;

code for collecting one or more patient care records into a database, comprising organizing one or more patient care records which each comprise a plurality of the collected measures sets, and storing the collected measures set into a patient care record for the individual patient within the database; and

code for analyzing one or more of the collected measures sets in the patient care record for the individual patient relative to one or more other collected measures sets stored in the database to determine a patient status indicator.

**52.** A storage medium according to Claim 51, the code for analyzing one or more of the collected measures sets further comprising:

code for operating a comparison module comparing an initial measure selected from the one or more collected measures sets to a sibling measure selected from the one or more other collected measures sets, the initial measure and the sibling measure both relating to the same type of patient information.

**53.** A storage medium according to Claim 51, the code for analyzing one or more of the collected measures sets further comprising:

code for operating a derivation module determining an initial derived measure using at least one measure selected from the one or more collected measures sets and determining a sibling derived measure using at least one measure selected from the one or more other collected measures sets, the initial derived measure and the sibling derived measure both relating to the same type of derived patient information; and

code for operating a comparison module comparing the initial derived measure to the sibling derived measure.

**54.** A storage medium according to Claim 51, the code for analyzing one or more of the collected measures sets further comprising:

code for operating a comparison module comparing an initial measure selected from the one or more collected measures sets to a peer measure selected from the one or more other collected measures sets, the initial measure relating to a different type of patient information than the peer measure.

**55.** A storage medium according to Claim 51, the code for analyzing one or more of the collected measures sets further comprising:

code for operating a derivation module determining a peer derived measure using at least one measure selected from the one or more other collected measures sets; and

code for operating a comparison module comparing an initial measure selected from the one or more collected measures sets to the peer derived measure, the initial measure relating to a different type of patient information than the derived patient information to which the peer derived measure relates.

**56.** A storage medium according to Claim 51, the code for analyzing one or more of the collected measures sets further comprising:

code for operating a derivation module determining an initial derived measure using at least one measure selected from the one or more collected measures sets; and

code for operating a comparison module comparing the initial derived measure to a peer measure selected from the one or more other collected measures sets, the initial derived measure relating to a different type of derived patient information than the patient information to which the peer measure relates.

**57.** A storage medium according to Claim 51, the code for analyzing one or more of the collected measures sets further comprising:

code for operating a derivation module determining an initial derived measure using at least one measure

selected from the one or more collected measures sets and determining a peer derived measure using at least one measure selected from the one or more other collected measures sets; and

code for operating a comparison module comparing the initial derived measure to the peer derived measure, the initial derived measure relating to a different type of derived patient information than the derived patient information to which the peer derived measure relates.

**58.** A storage medium according to Claim 51, further comprising:

code for operating a collection client communicatively interposed between the medical device adapted to be implanted and a network server, the collection client retrieving the collected measures set and downloading the collected measures set from the collection client into the network server.

**59.** A storage medium according to Claim 51, further comprising:

code for operating a feedback client interfaced to a feedback communications link over which automated feedback based on the patient status indicator is provided to the individual patient from the network server.

**60.** A storage medium according to Claim 59, the code for analyzing one or more of the collected measures sets further comprising:

code for operating a feedback module providing tiered feedback comprising:

at a first level of feedback, code for operatively communicating an interpretation of the patient status indicator to the individual patient over the feedback communications link;

at a second level of feedback, code for operatively communicating a notification of potential medical concern based on the patient status indicator to the individual patient over the feedback communications link;

at a third level of feedback, code for operatively communicating a notification of potential medical concern based on the patient status indicator to medical personnel in local proximity to the individual patient over the feedback communications link; and

at a fourth level of feedback, code for operatively communicating a set of reprogramming instructions based on the patient status indicator to the implantable medical device over the feedback communications link.

**61.** A storage medium according to Claim 51, the code for analyzing one or more of the collected measures sets further comprising:

code for operating an analysis module dynamically analyzing the one or more of the collected measures sets in the patient care record for the individual patient.

**62.** A storage medium according to Claim 51, the code for analyzing one or more of the collected measures sets further comprising:

code for operating an analysis module analyzing the one or more of the collected measures sets in the patient care record for the individual patient in a batch com-

prising the one or more of the collected measures sets in patient care records for a plurality of individual patients.

**63.** A system for collection and analysis of patient information for automated remote patient care, comprising:

a database collecting one or more patient care records, comprising:

a schema defining each patient care record comprising a plurality of collected measurements sets; and

each collected measurements set comprising individual measurements which each relate to patient information recorded by a medical device adapted to be implanted for an individual patient;

a server processing at least one of the collected measurements sets, comprising:

a receiver receiving a set of the collected measurements regularly stored and periodically sent from the implantable medical device;

a database module storing the collected measurements set into the patient care record in the database for the individual patient;

an analysis module analyzing one or more of the collected measurements sets in the patient care record for the individual patient relative to one or more other collected measurements sets stored in the patient care record of the individual patient; and

a feedback module sending feedback based on the analysis of the one or more collected measurements sets.

**64.** A system according to Claim 63, the analysis module further comprising:

a comparison module comparing at least one collected measurement selected from the one or more collected measurements sets to at least one other collected measurement selected from the one or more other collected measurements sets, the at least one collected measurement and the at least one other collected measurement both relating to the same type of patient information.

**65.** A system according to Claim 63, the analysis module further comprising:

a comparison module comparing at least one collected measurement selected from the one or more collected measurements sets to at least one other collected measurement selected from the one or more other collected measurements sets, the at least one collected measurement and the at least one other collected measurement both relating to different types of patient information.

**66.** A system according to Claim 63, the analysis module further comprising:

a derivation module determining at least one derived measurement using at least one collected measurement selected from at least one of the one or more collected measurements sets and the one or more other collected measurements sets; and

a comparison module comparing the at least one derived measurement to at least one measurement selected from

at least one of the one or more collected measurements sets and the one or more other collected measurements sets.

**67.** A system according to Claim 63, the analysis module further comprising:

a derivation module determining at least one derived measurement using at least one collected measurement selected from at least one of the one or more collected measurements sets and the one or more other collected measurements sets and determining at least one other derived measurement using at least one collected measurement selected from at least one of the one or more collected measurements sets and the one or more other collected measurements sets; and

a comparison module comparing the at least one derived measurement to the at least one other derived measurement.

**68.** A system according to Claim 63, the feedback module further comprising providing tiered feedback comprising:

at a first level of feedback, communicating an interpretation of the analysis of the one or more collected measurements sets to the individual patient;

at a second level of feedback, communicating a notification of potential medical concern based on the analysis of the one or more collected measurements sets to the individual patient;

at a third level of feedback, communicating a notification of potential medical concern based on the analysis of the one or more collected measurements sets to medical personnel in local proximity to the individual patient; and

at a fourth level of feedback, communicating a set of reprogramming instructions based on analysis of the one or more collected measurements sets to the implantable medical device.

**69.** A method for collection and analysis of patient information for automated remote patient care, comprising:

collecting one or more patient care records in a database, comprising:

defining each patient care record comprising a plurality of collected measurements sets; and

specifying each collected measurements set comprising individual measurements which each relate to patient information recorded by a medical device adapted to be implanted for an individual patient;

processing at least one of the collected measurements sets, comprising:

receiving a set of the collected measurements regularly stored and periodically sent from the implantable medical device;

storing the collected measurements set into the patient care record in the database for the individual patient;

analyzing one or more of the collected measurements sets in the patient care record for the individual patient relative to one or more other collected measurements sets stored in the patient care record of the individual patient; and

sending feedback based on the analysis of the one or more collected measurements sets.

**70.** A method according to Claim 69, the operation of analyzing further comprising:

comparing at least one collected measurement selected from the one or more collected measurements sets to at least one other collected measurement selected from the one or more other collected measurements sets, the at least one collected measurement and the at least one other collected measurement both relating to the same type of patient information.

**71.** A method according to Claim 69, the operation of analyzing further comprising:

comparing at least one collected measurement selected from the one or more collected measurements sets to at least one other collected measurement selected from the one or more other collected measurements sets, the at least one collected measurement and the at least one other collected measurement both relating to different types of patient information.

**72.** A method according to Claim 69, the operation of analyzing further comprising:

determining at least one derived measurement using at least one collected measurement selected from at least one of the one or more collected measurements sets and the one or more other collected measurements sets; and

comparing the at least one derived measurement to at least one measurement selected from at least one of the one or more collected measurements sets and the one or more other collected measurements sets.

**73.** A method according to Claim 69, the operation of analyzing further comprising:

determining at least one derived measurement using at least one collected measurement selected from at least one of the one or more collected measurements sets and the one or more other collected measurements sets;

determining at least one other derived measurement using at least one collected measurement selected from at least one of the one or more collected measurements sets and the one or more other collected measurements sets; and

comparing the at least one derived measurement to the at least one other derived measurement.

**74.** A method according to Claim 69, the operation of sending feedback further comprising:

providing tiered feedback comprising:

at a first level of feedback, communicating an interpretation of the analysis of the one or more collected measurements sets to the individual patient;

at a second level of feedback, communicating a notification of potential medical concern based on the analysis of the one or more collected measurements sets to the individual patient;

at a third level of feedback, communicating a notification of potential medical concern based on the analysis of the one or more collected measurements sets to medical personnel in local proximity to the individual patient; and

at a fourth level of feedback, communicating a set of reprogramming instructions based on analysis of the one or more collected measurements sets to the implantable medical device.

**75.** A computer-readable storage medium holding code for collection and analysis of patient information for automated remote patient care, comprising:

code for collecting one or more patient care records in a database, comprising:

code for defining each patient care record comprising a plurality of collected measurements sets; and

code for specifying each collected measurements set comprising individual measurements which each relate to patient information recorded by a medical device adapted to be implanted for an individual patient;

code for processing information for at least one of the collected measurements sets, comprising:

code for receiving a set of the collected measurements regularly stored and periodically sent from the implantable medical device;

code for storing the collected measurements set into the patient care record in the database for the individual patient;

code for analyzing one or more of the collected measurements sets in the patient care record for the individual patient relative to one or more other collected measurements sets stored in the patient care record of the individual patient; and

code for sending feedback based on the analysis of the one or more collected measurements sets.

**76.** A storage medium according to Claim 75, the operation of analyzing further comprising:

code for comparing at least one collected measurement selected from the one or more collected measurements sets to at least one other collected measurement selected from the one or more other collected measurements sets, the at least one collected measurement and the at least one other collected measurement both relating to the same type of patient information.

**77.** A storage medium according to Claim 75, the operation of analyzing further comprising:

code for comparing at least one collected measurement selected from the one or more collected measurements sets to at least one other collected measurement selected from the one or more other collected measurements sets, the at least one collected measurement and the at least one other collected measurement both relating to different types of patient information.

**78.** A storage medium according to Claim 75, the operation of analyzing further comprising:

code for determining at least one derived measurement using at least one collected measurement selected from at least one of the one or more collected measurements sets and the one or more other collected measurements sets; and

code for comparing the at least one derived measurement to at least one measurement selected from at least one

of the one or more collected measurements sets and the one or more other collected measurements sets.

**79.** A storage medium according to Claim 75, the operation of analyzing further comprising:

code for determining at least one derived measurement using at least one collected measurement selected from at least one of the one or more collected measurements sets and the one or more other collected measurements sets;

code for determining at least one other derived measurement using at least one collected measurement selected from at least one of the one or more collected measurements sets and the one or more other collected measurements sets; and

code for comparing the at least one derived measurement to the at least one other derived measurement.

**80.** A storage medium according to Claim 75, the operation of sending feedback further comprising:

code for providing tiered feedback comprising:

at a first level of feedback, code for communicating an interpretation of the analysis of the one or more collected measurements sets to the individual patient;

at a second level of feedback, code for communicating a notification of potential medical concern based on the analysis of the one or more collected measurements sets to the individual patient;

at a third level of feedback, code for communicating a notification of potential medical concern based on the analysis of the one or more collected measurements sets to medical personnel in local proximity to the individual patient; and

at a fourth level of feedback, code for communicating a set of reprogramming instructions based on analysis of the one or more collected measurements sets to the implantable medical device.

**81.** A system for automated remote cardiac patient care using cardiovascular patient information retrieved from a cardiac monitoring device adapted to be implanted in a patient, comprising:

a telemetry transceiver retrieving on a substantially regular basis a set of cardiovascular measurements regularly recorded by and stored in the cardiac monitoring device adapted to be implanted and periodically communicating the collected cardiovascular measurements set;

a centralized server, comprising:

a database module storing the collected cardiovascular measurements set into a patient care record for the individual patient;

a database coupled to the centralized server organizing a plurality of patient care records in the database, comprising defining each patient care record comprising a plurality of the collected cardiovascular measurements sets, and specifying each collected cardiovascular measurements set comprising individual cardiovascular measurements which each relate to patient information recorded by the cardiac monitoring device for an individual patient;

an analysis module analyzing one or more of the collected cardiovascular measurements sets in the patient care record for the individual patient relative to one or more other collected cardiovascular measurements sets stored in the patient care records in the database; and

a feedback module sending feedback based on the analysis of the one or more collected cardiovascular measurements sets to the individual patient.

**82.** A method for automated remote cardiac patient care using cardiovascular patient information retrieved from a cardiac monitoring device adapted to be implanted in a patient, comprising:

retrieving on a substantially regular basis a set of cardiovascular measurements regularly recorded by and stored in the cardiac monitoring device adapted to be implanted;

periodically communicating the collected cardiovascular measurements set to a centralized server;

storing the collected cardiovascular measurements set into a patient care record for the individual patient in a database coupled to the centralized server;

organizing a plurality of patient care records in the database, comprising:

defining each patient care record comprising a plurality of the collected cardiovascular measurements sets; and

specifying each collected cardiovascular measurements set comprising individual cardiovascular measurements which each relate to patient information recorded by the cardiac monitoring device for an individual patient;

analyzing one or more of the collected cardiovascular measurements sets in the patient care record for the individual patient relative to one or more other collected cardiovascular measurements sets stored in the patient care records in the database; and

sending feedback based on the analysis of the one or more collected cardiovascular measurements sets to the individual patient.

\* \* \* \* \*

专利名称(译)	用于收集和分析用于自动远程患者护理的患者信息的系统和方法		
公开(公告)号	<a href="#">US20040147981A1</a>	公开(公告)日	2004-07-29
申请号	US10/646104	申请日	2003-08-22
[标]申请(专利权)人(译)	BARDY GUST ^ h		
申请(专利权)人(译)	BARDY GUST ^ h		
当前申请(专利权)人(译)	BARDY GUST ^ h		
[标]发明人	BARDY GUST H		
发明人	BARDY, GUST H.		
IPC分类号	A61B5/00 G16H10/60 A61N1/08		
CPC分类号	A61B5/0031 G06F19/322 G06F19/3406 A61B5/0205 G06Q50/24 Y10S128/92 G06F19/3418 G16H10/60 G16H40/63		
其他公开文献	US7134996		
外部链接	<a href="#">Espacenet</a> <a href="#">USPTO</a>		

摘要(译)

公开了一种用于收集和分析用于自动远程患者护理的患者信息的系统和方法。收集数据库中的患者护理记录。定义每个患者护理记录并包括收集的测量集。每个收集的测量集被指定并包括各个测量值，每个测量值与由适于植入的医疗设备记录的患者信息相关。处理至少一个收集的测量集。接收从可植入医疗设备定期存储和定期发送的一组收集的测量值。收集的测量集存储在患者护理记录中。相对于存储在患者护理记录中的一个或多个其他收集的测量集，在患者护理记录中针对个体患者分析一个或多个收集的测量集。发送基于对一个或多个收集的测量集的分析的反馈。

