

(19)



(11)

**EP 2 121 091 B1**

(12)

**EUROPEAN PATENT SPECIFICATION**

(45) Date of publication and mention of the grant of the patent:  
**28.11.2018 Bulletin 2018/48**

(21) Application number: **08732032.1**

(22) Date of filing: **12.03.2008**

(51) Int Cl.:

<b>A61B 17/12</b> <small>(2006.01)</small>	<b>A61F 2/04</b> <small>(2013.01)</small>
<b>A61B 1/267</b> <small>(2006.01)</small>	<b>A61B 5/00</b> <small>(2006.01)</small>
<b>A61B 5/08</b> <small>(2006.01)</small>	<b>A61M 16/00</b> <small>(2006.01)</small>
<b>A61M 16/04</b> <small>(2006.01)</small>	<b>A61M 16/20</b> <small>(2006.01)</small>
<b>A61M 25/10</b> <small>(2013.01)</small>	

(86) International application number:  
**PCT/US2008/056706**

(87) International publication number:  
**WO 2008/112797 (18.09.2008 Gazette 2008/38)**

**(54) DEVICES FOR PASSIVE RESIDUAL LUNG VOLUME REDUCTION AND FUNCTIONAL LUNG VOLUME EXPANSION**

VORRICHTUNGEN FÜR PASSIVE RESIDUALVOLUMENREDUKTION UND FUNKTIONELLE LUNGENVOLUMENEXPANSION

DISPOSITIFS PERMETTANT LA RÉDUCTION PASSIVE DU VOLUME RÉSIDUEL DES POUMONS ET LA DILATATION FONCTIONNELLE DU VOLUME DES POUMONS

(84) Designated Contracting States:  
**AT BE BG CH CY CZ DE DK EE ES FI FR GB GR HR HU IE IS IT LI LT LU LV MC MT NL NO PL PT RO SE SI SK TR**

(30) Priority: **12.03.2007 US 685008**

(43) Date of publication of application:  
**25.11.2009 Bulletin 2009/48**

(73) Proprietor: **Pulmonx Corporation**  
**Redwood City, CA 94063 (US)**

(72) Inventors:  
• **ALJURI, Nikolai**  
**Hillsborough, California 94010 (US)**

• **PERKINS, Rodney C.**  
**Woodside, California 94062 (US)**

(74) Representative: **Kazi, Ilya**  
**Mathys & Squire LLP**  
**The Shard**  
**32 London Bridge Street**  
**London SE1 9SG (GB)**

(56) References cited:  
**EP-A2- 0 982 044**      **WO-A1-2006/091597**  
**WO-A2-00/41612**      **US-A- 3 794 026**  
**US-A- 5 588 424**      **US-A1- 2002 169 413**  
**US-A1- 2003 171 332**      **US-A1- 2005 288 684**  
**US-A1- 2006 264 772**      **US-A1- 2006 264 772**  
**US-A1- 2006 264 772**      **US-B1- 6 398 775**

**EP 2 121 091 B1**

Note: Within nine months of the publication of the mention of the grant of the European patent in the European Patent Bulletin, any person may give notice to the European Patent Office of opposition to that patent, in accordance with the Implementing Regulations. Notice of opposition shall not be deemed to have been filed until the opposition fee has been paid. (Art. 99(1) European Patent Convention).

## Description

### BACKGROUND OF THE INVENTION

#### 1. Field of the Invention.

**[0001]** The present invention relates generally to medical apparatus. More particularly, the present invention relates to apparatus for endobronchial residual lung volume reduction by passive deflation of hyperinflated segments with functional lung volume expansion as a result.

**[0002]** Chronic obstructive pulmonary disease is a significant medical problem affecting 16 million people or about 6% of the U.S. population. Specific diseases in this group include chronic bronchitis, asthmatic bronchitis, and emphysema. While a number of therapeutic interventions are used and have been proposed, none are completely effective, and chronic obstructive pulmonary disease remains the fourth most common cause of death in the United States. Thus, improved and alternative treatments and therapies would be of significant benefit.

**[0003]** Of particular interest to the present invention, lung function in patients suffering from some forms of chronic obstructive pulmonary disease can be improved by reducing the effective lung volume, typically by resecting diseased portions of the lung. Resection of diseased portions of the lungs both promotes expansion of the non-diseased regions of the lung and decreases the portion of inhaled air which goes into the lungs but is unable to transfer oxygen to the blood. Lung volume reduction is conventionally performed in open chest or thoracoscopic procedures where the lung is resected, typically using stapling devices having integral cutting blades.

**[0004]** While effective in many cases, conventional lung volume reduction surgery is significantly traumatic to the patient, even when thoracoscopic procedures are employed. Such procedures often result in the unintentional removal of healthy lung tissue, and frequently leave perforations or other discontinuities in the lung which result in air leakage from the remaining lung. Even technically successful procedures can cause respiratory failure, pneumonia, and death. In addition, many older or compromised patients are not able to be candidates for these procedures.

**[0005]** As an improvement over open surgical and minimally invasive lung volume reduction procedures, endobronchial lung volume reduction procedures have been proposed. For example, U.S. Patent Nos. 6,258,100 and 6,679,264 describe placement of one-way valve structures in the airways leading to diseased lung regions. It is expected that the valve structures will allow air to be expelled from the diseased region of the lung while blocking reinflation of the diseased region. Thus, over time, the volume of the diseased region will be reduced and the patient condition will improve.

**[0006]** While promising, the use of implantable, one-way valve structures is problematic in at least several respects. The valves must be implanted prior to assess-

ing whether they are functioning properly. Thus, if the valve fails to either allow expiratory flow from or inhibit inspiratory flow into the diseased region, that failure will only be determined after the valve structure has been implanted, requiring surgical removal. Additionally, even if the valve structure functions properly, many patients have diseased lung segments with collateral flow from adjacent, healthy lung segments. In those patients, the lung volume reduction of the diseased region will be significantly impaired, even after successfully occluding inspiration through the main airway leading to the diseased region, since air will enter collaterally from the adjacent healthy lung region. When implanting one-way valve structures, the existence of such collateral flow will only be evident after the lung region fails to deflate over time, requiring further treatment.

**[0007]** For these reasons, it would be desirable to provide improved and alternative methods and apparatus for effecting residual lung volume reduction in hyperinflated and other diseased lung regions. The methods and apparatus will preferably allow for passive deflation of an isolated lung region without the need to implant a one-way valve structure in the lung. The methods and apparatus will preferably be compatible with known protocols for occluding diseased lung segments and regions after deflation, such as placement of plugs and occluding members within the airways leading to such diseased segments and regions. Additionally, such methods and devices should be compatible with protocols for identifying and treating patients having diseased lung segments and regions which suffer from collateral flow with adjacent healthy lung regions. At least some of these objectives will be met by the invention described hereinbelow.

#### 2. Description of the Background Art.

**[0008]** Methods for performing minimally invasive and endobronchial lung volume reduction are described in the following U.S. patents and publications:  
5,972,026; 6,083,255; 6,258,100; 6,287,290; 6,398,775; 6,527,761; 6,585,639; 6,679,264; 6,709,401; 6,878,141; 6,997,918; 2001/0051899; and 2004/0016435.

**[0009]** In addition, US 2006/0264772 describes minimally invasive methods, systems and devices for qualitatively and quantitatively assessing collateral ventilation in the lungs. In particular, collateral ventilation of a target compartment within a lung of a patient is assessed by advancement of a catheter through the tracheobronchial tree to a feeding bronchus of the target compartment. The feeding bronchus is occluded by the catheter and a variety of measurements are taken with the use of the catheter in a manner which is of low risk to the patient. Examples of such measurements include but are not limited to flow rate, volume and pressure. These measurements are used to determine the presence of collateral ventilation and to quantify such collateral ventilation.

**[0010]** US 2002/0169413 describes methods and apparatus for treating congestive heart by actively or pas-

sively enhancing perfusion to the renal arteries. A first example comprises a specially configured balloon catheter and extracorporeal pump, wherein the pump operates in a "once-through" fashion or alternating volume displacement mode. In another example the catheter includes a pair of balloons to isolate a region of the aorta, and a third balloon that directs flow into the renal arteries.

In still further examples, a stent or cuff having a constricted region is deployed in or around the aorta, respectively, to create a backpressure upstream of the stent or cuff. **[0011]** US 6,398,775 describes apparatus, systems, methods, and kits for isolating a target lung segment and treating that segment, usually by drug delivery or lavage. The systems include at least a lobar or sub-lobar isolation catheter which is introduced beyond a second lung bifurcation (i.e., beyond the first bifurcation in a lobe of the lung) and which can occlude a bronchial passage at that point. An inner catheter is usually introduced through the isolation catheter and used in cooperation with the isolation catheter for delivering and/or removing drugs or washing liquids from the isolated lung region. Optionally, the inner catheter also has an occluding member near its distal end for further isolation of a target region within the lung.

**[0012]** Finally, EP 0,982,044 describes an apparatus/method for detecting an empty breathing gas compartment condition in a bellows ventilator for a patient. The apparatus includes a first sensor for measuring, during inspiration, the incoming flow of gas into a driving gas compartment located in the bellows container. The second sensor measures the pressure in the driving gas compartment. During the inspiration cycle, measurements taken by the first and second sensors are signalled to a control unit and used to determine a  $\Delta V/\Delta p$  compliance value. The compliance value will be large if the bellows is movable, i.e. not in the empty breathing compartment gas condition. The compliance value is small if the empty breathing gas compartment condition exists. The compliance value, so determined, is compared with a reference compliance value in the control unit to detect the empty breathing gas compartment condition.

#### BRIEF SUMMARY OF THE INVENTION

**[0013]** The present invention is defined by the appended claims. Associated methods are also described herein to aid understanding the invention. These methods do not form part of the claimed invention.

**[0014]** The present disclosure provides methods and apparatus for passively reducing the residual volume (the volume of air remaining after maximal exhalation) of hyperinflated or otherwise diseased lung compartments or segments. By "passively reducing," it is meant that air can be removed from the diseased lung region without the use of a vacuum aspiration to draw the air from the region. Typically, such passive reduction will rely on a non-implanted one-way flow element, structure, or assembly which permits air to be exhaled or exhausted from

the lung region while preventing or inhibiting the inspiration of air back into the lung region. By non-implanted, it is meant that some portion of the element, structure, or assembly will be temporarily placed in an airway or bronchus leading to the lung region in a manner that allows that portion to be removed later, typically within days or hours, without the need for surgical intervention. Thus, the methods of the present disclosure will not require the permanent implantation of valves or other structures prior to actually achieving the desired residual lung volume reduction, as with the one-way implantable valve structures of the prior art.

**[0015]** The methods and apparatus of the present disclosure can be terminated and all apparatus removed should it appear for any reason that the desired residual lung volume reduction is not being achieved. Commonly, such failure can be the result of collateral flow into the diseased lung region from adjacent healthy lung region(s). In such cases, steps can be taken to limit or stop the collateral flow and allow resumption of the passive lung volume reduction protocols. In other cases, it might be desirable or necessary to employ open surgical, thoracoscopic, or other surgical procedures for lung resection.

**[0016]** Patients who successfully achieve residual volume reduction of hyperinflated or other diseased lung regions in accordance with the principles of the present disclosure will typically have those regions sealed permanently to prevent reinflation. Such sealing can be achieved by a variety of known techniques, including the application of radiofrequency or other energy for shrinking or sealing the walls of the airways feeding the lung region. Alternatively, synthetic or biological glues could be used for achieving sealing of the airway walls. Most commonly, however, expandable plugs will be implanted in the airways leading to the deflated lung region to achieve the sealing.

**[0017]** In a first aspect of the present disclosure, methods for reducing the residual volume of a hyperinflated lung compartment comprise sealingly engaging a distal end of a catheter in an airway feeding the lung compartment. Air is allowed to be expelled from the lung compartment through a passage in the catheter while the patient is exhaling, and air is blocked from re-entering the lung compartment through the catheter passage while the patient is inhaling. As the residual volume diminishes, the hyperinflated lung compartment reduces in size freeing up the previously occupied space in the thoracic cavity. Consequently, a greater fraction of the Total Lung Capacity (TLC), which is the volumetric space contained in the thoracic cavity that is occupied by lung tissue after a full inhalation becomes available for the healthier lung compartments to expand and the volume of the lung available for gas exchange commonly referred to in clinical practice as the lung's Functional Vital Capacity (FVC) or Vital Capacity (VC) increases, the result of which is effectively a functional lung volume expansion.

**[0018]** The hyperinflated lung compartment will usually be substantially free of collateral flow from adjacent lung compartments, and optionally the patient can be tested for the presence of such collateral flow, for example using techniques taught in copending, commonly assigned application numbers 11/296,951 (US 2006/0264772) (Attorney Docket No.: 017534-002820US), filed on December 7, 2005; 11/550,660 (US 2007/0142742) (Attorney Docket No. 017534-003020US), filed on October 18, 2006; and application number 11/428,762 (Attorney Docket No. 017534-003010US), filed on July 5, 2006.

**[0019]** Alternatively, the methods of the present disclosure for reducing residual lung volume can be performed in patients having collateral flow channels leading into the hyperinflated or other diseased lung compartment. In such cases, the collateral flow channels may first be blocked, for example, by introducing glues, occlusive particles, hydrogels or other blocking substances, as taught for example in copending application no. 11/684,950 (Attorney Docket No. 017534-004000US), filed on March 12, 2008. In other cases, where the flow channels are relatively small, those channels will partially or fully collapse as the residual lung volume is reduced. In such cases, the patient may be treated as if the collateral flow channels did not exist. The effectiveness of reduction in hyperinflation however will depend on the collateral resistance between the hyperinflated compartment and the neighboring compartments, as illustrated in Fig. 9, where residual volume reduction is negligible when the resistance to collateral flow  $R_{coll}$  is very small (significant collateral flow channels) and maximally effective when  $R_{coll}$  is very high (no collateral flow channels).

**[0020]** In all of the above methods, it may be desirable to introduce an oxygen-rich gas into the lung compartment while or after the lung volume is reduced in order to induce or promote absorption atelectasis. Absorption atelectasis promotes absorption of the remaining or residual gas in the compartment into the blood to further reduce the volume, either before or after permanent sealing of the lung volume compartment or segment.

**[0021]** In a second aspect, the present disclosure provides catheters for isolating and deflating hyperinflated and other diseased lung compartments. The catheter comprises a catheter body, an expandable occluding member on the catheter body, and a one-way flow element associated with the catheter body. The catheter body usually has a distal end, a proximal end, and at least one lumen extending from a location at or near the distal end to a location at or near the proximal end. At least a distal portion of the catheter body is adapted to be advanced into and through the airways of a lung so that the distal end can reach an airway which feeds a target lung compartment or segment to be treated. The expandable occluding member is disposed near the distal end of the catheter body and is adapted to be expanded in the airway which feeds the target lung compartment or segment so that said compartment or segment can be isolated with access provided only through the lumen or

catheter body when the occluding member is expanded. The one-way flow element is adapted to be disposed within or in-line with the lumen of the catheter body in order to allow flow in a distal-to-proximal direction so that air will be expelled from the isolated lung compartment or segment as the patient exhales. The one-way flow element, however, inhibits or prevents flow through the lumen in a proximal-to-distal direction so that air cannot enter the isolated lung compartment or segment while the patient is inhaling.

**[0022]** For the intended endobronchial deployment, the catheter body will typically have a length in the range from 20 cm to 200 cm, preferably from 80 cm to 120 cm, and a diameter near the distal end in the range from 0.1 mm to 10 mm, preferably from 1 mm to 5 mm. The expandable occluding member will typically be an inflatable balloon or cuff, where the balloon or cuff has a width in the range from 1 mm to 30 mm, preferably from 5 mm to 20mm, when inflated. The one-way flow element is typically a conventional one-way flow valve, such as a duck-bill valve, a flap valve, or the like, which is disposed in the lumen of the catheter body, either near the distal end or at any other point within the lumen. Alternatively, the one-way flow element could be provided as a separate component, for example, in a hub which is detachably mounted at the proximal end of the catheter body. In other instances, it might be desirable to provide two or more one-way flow elements in series within the lumen or otherwise provided in-line with the lumen in order to enhance sealing in the inspiratory direction through the lumen. In a particular illustrated embodiment, a one-way flow control assembly is provided as part of an external console attached in-line with the catheter lumen. The flow-control assembly comprises a valve that is controlled electrically or through other means, sensors for sensing flow and pressure in the lumen, and a valve controller for controlling the valve based on input from the sensors. The sensors monitor flow to detect the beginning of an inhalation cycle and pressure to detect the beginning of an exhalation cycle. Based on the input from the sensors, the valve controller opens the valve at the beginning of the exhalation cycle to deflate the lung region and closes the valve at the beginning of the inhalation cycle to prevent re-inflation of the lung region.

## BRIEF DESCRIPTION OF THE DRAWINGS

### [0023]

Fig. 1 is a perspective view of an isolation and deflation catheter constructed in accordance with the principles of the present invention.

Figs. 2-4 illustrate alternative placements of one-way flow elements within a central lumen of the catheter of Fig. 1.

Fig. 5a shows an alternative embodiment of a one-

way flow element comprising a valve controller coupled to sensors and an electrically-controlled valve.

Fig 5b shows an external console housing the one-way flow element shown in Fig. 5a.

Fig. 6a shows a flowchart and Fig. 6b show flow and pressure graphs, illustrating the operation of the one-way flow element shown in Fig. 5a.

Fig. 7 illustrates the trans-esophageal endobronchial placement of the catheter of Fig. 1 in an airway leading to a diseased lung region in accordance with the principles of the present invention.

Figs. 8A-8D illustrate use of the catheter as placed in Fig. 7 for isolating and reduction of the volume of the diseased lung region in accordance with the principles of the present invention.

Fig. 9 is a graph showing the relationship between collateral resistance  $R_{coll}$  and residual volume reduction in an isolated lung compartment

#### DETAILED DESCRIPTION OF THE INVENTION

**[0024]** Referring to Fig. 1, an endobronchial lung volume reduction catheter 10 constructed in accordance with the principles of the present invention includes an elongate catheter body 12 having a distal end 14 and a proximal end 16. Catheter body 12 includes at least one lumen or central passage 18 extending generally from the distal end 14 to the proximal end 16. Lumen 18 will have a distal opening 19 at or near the distal end 14 in order to permit air or other lung gases to enter the lumen and flow in a distal-to-proximal direction out through the proximal end of the lumen. Additionally, catheter body 12 will have an expandable occluding element 15 at or near the distal end 14, to occlude an air passageway during treatment. Optionally, a hub 20 will be provided at the proximal end, but the hub is not a necessary component of the catheter.

**[0025]** The present invention relies on placement of a one-way flow element within or in-line with the lumen 18 so that flow from an isolated lung compartment or segment (as described hereinbelow) may occur in a distal-to-proximal direction but flow back into the lung compartment or segment is inhibited or blocked in the proximal-to-distal direction. As shown in Figs. 2-4, a one-way flow element 22 may be provided in the lumen 18 near the distal end 14 of the catheter body 12, optionally being immediately proximal of the distal opening 19. As shown, the one-way flow element 22 is a duck-bill valve which opens as shown in broken line as the patient exhales to increase the pressure on the upstream or distal side of the valve 22. As the patient inhales, the pressure on the upstream or distal side of the valve is reduced, drawing the valve leaflets closed as shown in full line.

**[0026]** Alternatively or additionally, the one-way flow element 22 could be provided anywhere else in the lumen 18, and two, three, four, or more such valve structures could be included in order to provide redundancy.

5 **[0027]** As a third option, a one-way valve structure 26 in the form of a flap valve could be provided within the hub 20. The hub 20 could be removable or permanently fixed to the catheter body 12. Other structures for providing in-line flow control could also be utilized, as will be presently described.

10 **[0028]** In addition to the passive one-way valve structures described above, one-way flow functionality may be provided using an actively controlled one-way flow control assembly. One-way flow can be controlled by measuring the flow and pressure through the lumen and using this information to determine the beginning and end of inhalation and exhalation cycles and thereby determining whether the valve should remain open or closed. In one embodiment, the one-way flow control assembly is provided as part of an external console attached in-line with the catheter lumen. The console comprises a channel for air flow to which the proximal end of the catheter connects via a standard connector. When the patient exhales, air is forced through the catheter lumen into the console's air channel, and then exits through an exhaust port of the console. The one-way flow control assembly comprises a valve that is within or in-line with the catheter lumen and can be opened or closed by a valve controller to control the air flow through the air channel. The valve controller opens and closes the valve based on input from flow and pressure sensors within or in-line with the catheter lumen. The sensors measure the air flow and air pressure to detect the inhalation and exhalation cycles of the patient. Based on input from the sensors, the valve controller opens the valve at the beginning of the exhalation cycle, and closes the valve at the beginning of the inhalation cycle. The valve controller may control the valve electrically, magnetically, mechanically or through other means known in the art.

20 25 30 35 40 **[0029]** Fig. 5a shows an illustration of such an actively controlled one-way flow control assembly provided as part of an external console. The external console 60 comprises an air channel 61, a connector 62, and an exhaust port 64. Catheter 10 is detachably coupled to air channel 61 using a standard connector 62, such that air channel 61 is in-line with lumen 18. Preferably, a filter 63 is provided between the air channel 61 and lumen 18 to maintain sterility of air channel 61 and promote reusability of console 60. Additionally, air flowing into air channel 61 is expelled through exhaust port 64. Console 60 comprises a one-way flow assembly 70 in-line with lumen 18 of catheter 10.

45 50 55 **[0030]** One-way flow assembly 70 comprises an electrically controlled valve 71, a flow sensor 73, a pressure sensor 74, and a valve controller 75. In one embodiment, valve 71, flow sensor 73, and pressure sensor 74 are disposed within air channel 61. Valve controller 75 provides one-way flow functionality by opening and closing

valve 71 based on flow and pressure signals received from sensors 73 and 74, respectively. When valve 71 is closed, it prevents air from flowing into the lumen of catheter 10 (during inhalation); during exhalation, valve 71 remains open and allows air to flow out of the isolated lung compartment.

**[0031]** In one embodiment, valve 71 is a solenoid-based valve. Alternatively, valve 71 may be any other valve that can be opened and closed via an electrical control signal. Flow sensor 73 and pressure sensor 74, respectively, measure air flow and pressure in lumen 18. Valve controller 75 receives a flow indicator signal 76 from the flow sensor 73 and a pressure indicator signal 77 from pressure sensor 74 and produces a valve control signal 78 to open or close valve 71. Alternatively, one or more of flow sensor 73, pressure sensor 74, and valve 71 may reside within lumen 18 and be in communication with valve controller 75 via connections between the catheter 10 and console 60.

**[0032]** Fig. 5b shows one embodiment of of an external console 60 connected to catheter 10. External console 60 optionally comprises a visual display 79 that receives and displays flow and pressure data as sensed by sensors 73 and 74, for example, via a connection 72 to the controller 75. Optionally, visual display 79 is a touch-screen display allowing a user to interact with console 60.

**[0033]** Figs. 6a and 6b illustrate the operation of one-way flow assembly 70. Fig. 6a is a flowchart showing the operational steps of valve controller 75 as it produces the electrical valve control signal 78 to open or close valve 71 based on input from flow sensor 73 and pressure sensor 74. Fig. 6b is a graph showing exemplary signals generated by the flow sensor 73 (top panel) and pressure sensor 74 (bottom panel) during a series of respiration cycles. The flow and pressure direction during exhalation is herein referred to as the positive flow and pressure direction and plotted on the positive ordinate of the graphs in Fig. 6B, and the flow and pressure direction during inhalation is referred to as the negative flow direction and plotted on the negative ordinate of Fig. 6B.

**[0034]** Initially, the patient may breathe normally through lumen 18 of catheter 10. Once the treatment is initiated-which could be accomplished using the touch-screen display 79 - valve controller 75 waits for the completion of an inhalation cycle, until flow sensor 73 indicates a flow value that is greater than a specified flow threshold value. This is shown as step 81 in Fig. 6a and shown as the first flow and pressure cycle in Fig. 6B lasting for a period indicated as 81p. The flow threshold value is chosen to indicate the beginning of an exhalation cycle. Figs. 6a and 6b and the present description assume an exemplary flow threshold value of zero. Optionally, the flow threshold value is configurable to a value other than zero.

**[0035]** In step 82 in Fig. 6a (also indicating the positive flow and pressure in Fig. 6b), valve controller 75 maintains valve 71 in an open state during exhalation until flow sensor 73 receives a flow value less than or equal

to zero. Thus, as is illustrated in Fig. 6b, step 82 lasts for a period indicated as 82p as long as flow sensor 73 senses an air flow value greater than zero.

**[0036]** When flow sensor 73 senses a flow value that is less than or equal to zero, valve controller 75 closes valve 71 in step 83 in Fig. 6a and no air flows through the lumen into the lung compartment. As is shown in Fig. 6b, Step 83 occurs contemporaneously with the flow value reaching zero or lower at the point in time denoted 83p. Typically, the flow reduces to zero at the end of exhalation, at which point valve controller 75 closes the valve 71.

**[0037]** The following steps of valve controller 75 refer to a pressure threshold value. The pressure threshold value is chosen to indicate the beginning of an exhalation cycle. This value is configurable, and in what follows, an example pressure threshold value of zero is assumed.

**[0038]** Ideally, it is desirable that valve controller 75 reopen valve 71 when the pressure increases to or above the pressure threshold value. Realistically, given hardware imperfections, the pressure as sensed and reported by pressure sensor 74 at the end of exhalation may fluctuate around zero, causing chatter of valve 71. To prevent valve chatter, in step 84, valve controller 75 maintains valve 71 in a closed state while the pressure remains above a specified minimum pressure value, denoted as min\_pressure in Figs. 6a and 6b. This minimum pressure--min\_pressure-- is configurable and set to a value appreciably less than the specified pressure threshold value. Thus, as is further shown in Fig. 6b, valve 71 remains closed during the period 84p.

**[0039]** Optionally, during step 84, valve controller 75 also monitors pressure to ensure that valve 71 will open if the patient starts exhalation prior to the pressure decreasing to below min\_pressure. To this end, during step 84, valve controller 75 is optionally configured to open valve 71 if pressure increases to a value that is above the pressure threshold value by an amount referred to as a safeguard offset value. The safeguard offset value is configurable.

**[0040]** During step 85 in Fig. 6a, once the pressure passes below "min\_pressure", valve controller 75 maintains valve 71 in a closed state until the pressure increases to or passes the pressure threshold value. Referring to Fig. 6b, step 85 lasts the duration between the achievement of min\_pressure in step 84 and the attainment of the pressure threshold value, with the period denoted as 85p in Fig. 6b.

**[0041]** When the pressure increases to or passes the pressure threshold value, the valve controller 75 opens the valve 71 at step 86 in Fig. 6a. Thus, referring to Fig. 6b, the opening of the valve in step 86 occurs at point 86p and is contemporaneous with the pressure increasing to or passing a zero value. This allows air to empty from the lung compartment in communication with lumen 18.

**[0042]** Thereafter, as the patient resumes inhalation, the valve controller 75 resumes operation at Step 82

(close valve 71 and prevent airflow into the target lung compartment), for a new respiration cycle, until the lung reduction process is terminated.

**[0043]** Use of the endobronchial lung volume reduction catheter 10 to reduce the residual volume of a diseased region DR of a lung L is illustrated beginning in Fig. 7. Catheter 10 is introduced through the patient's mouth, down past the trachea T and into a lung L. The distal end 14 of the catheter 10 is advanced to the main airway AW leading into the diseased region DR of the lung. Introduction and guidance of the catheter may be achieved in conventional manners, such as described in commonly-owned U.S. Patent Nos. 6,287,290; 6,398,775; and 6,527,761.

**[0044]** Referring now to Figs. 8A-D, functioning of the one-way valve element in achieving the desired lung volume reduction will be described. After the distal end 14 of the catheter 10 is advanced to the feeding airway AW, an expandable occluding element 15 is expanded to occlude the airway. The expandable occluding element may be a balloon, cuff, or a braided balloon as described in copending applications 60/823,734 (Attorney Docket No. 017534-003800US), filed on August 28, 2006, and 60/828,496 (Attorney Docket No. 017534-003900US) filed on October 6, 2006. At that point, the only path between the atmosphere and the diseased region DR of the lung is through the lumen 18 of the catheter 10. As the patient exhales, as shown in Fig. 8A, air from the diseased region DR flows outwardly through the lumen 18 and the one-way valve element 22, one-way flow assembly 70, or any other one-way flow structure, causing a reduction in residual air within the region and a consequent reduction in volume. Air from the remainder of the lung also passes outward in the annular region around the catheter 10 in a normal manner.

**[0045]** As shown in Fig. 8B, in contrast, when the patient inhales, no air enters the diseased regions DR of the lung L (as long as there are no significant collateral passageways), while the remainder of the lung is ventilated through the region around the catheter. It will be appreciated that as the patient continues to inhale and exhale, the air in the diseased region DR is incrementally exhausted, further reducing the lung volume as the external pressure from the surrounding regions of the lung are increased relative to the pressure within the diseased region. As shown in Fig. 8C, after sometime, typically seconds to minutes, air flow from the isolated lung segment will stop and a maximum or near-maximum level of residual lung volume reduction within the diseased region DR will have been achieved. At that time, the airway AW feeding the diseased region DR can be occluded, by applying heat, radiofrequency energy, glues, or preferably by implanting an occluding element 30, as shown in Fig. 8D. Implantation of the occluding element may be achieved by any of the techniques described in commonly-owned U.S. Patent Nos. 6,287,290; and 6,527,761.

**[0046]** While the above is a complete description of the preferred embodiments of the invention, various alterna-

tives, modifications, and equivalents may be used. Therefore, the above description should not be taken as limiting the scope of the invention which is defined by the appended claims.

## Claims

1. A medical apparatus comprising:  
a catheter (10) for isolating and deflating a hyperinflated lung compartment, said catheter (10) comprising:

a catheter body (12) having a distal end (14), a proximal end (16), and at least one lumen (18) extending from the distal end (14) to the proximal end (16), wherein at least a distal portion of the catheter body is adapted to be advanced through the airways of the lung;

an expandable occluding member (15) disposed near the distal end (14) of the catheter body, wherein said occluding member (15) is adapted to be expanded in an airway which feeds the hyperinflated lung compartment such that access to the compartment is provided only through the lumen (18) when the occluding member (15) is expanded; and

a one-way flow assembly (70) comprising:

a one-way flow element (71) adapted to be disposed within or in-line with the lumen (18) so that flow in a distal-to-proximal direction is allowed and flow in a proximal-to-distal direction is inhibited or prevented; and

a flow sensor (73), a pressure sensor (74) and a valve controller (75); wherein the flow sensor (73) monitors flow to detect the beginning of an inhalation cycle, the pressure sensor (74) monitors pressure to detect the beginning of an exhalation cycle and the valve controller (75) opens the one-way flow element at the beginning of the exhalation cycle to deflate the hyperinflated lung compartment and closes the one-way flow element at the beginning of the inhalation cycle to prevent reinflation of the hyperinflated lung compartment.

2. A medical apparatus as in claim 1, wherein the catheter body (12) has a length in the range from 20 cm to 200 cm and a diameter near the distal end (14) in the range from 0.1 mm to 10 mm.

3. A medical apparatus as in claims 1 or 2, wherein the expandable occluding member (15) is an inflatable balloon, cuff, or braided balloon.

4. A medical apparatus as in any one of the preceding

claims, wherein the expandable occluding member (15) has a width in the range from 1 mm to 30 mm when fully expanded.

5. A medical apparatus as in any one of the preceding claims, wherein the one-way flow element (71) is disposed in the lumen. 5
6. A medical apparatus as in claim 5, wherein the one-way flow element (71) is disposed near the distal end of the catheter body. 10
7. A medical apparatus as in any one of claims 1 to 4, further comprising a hub (20) disposed on a proximal end of the catheter body. 15
8. A medical apparatus as in claim 7, wherein a second one-way flow element is disposed in the hub (20).
9. A medical apparatus as in claim 7 or 8, wherein the hub (20) is removable and can be attached in-line with the lumen (18). 20
10. A medical apparatus for isolating and deflating a hyperinflated lung compartment as in claim 1, wherein the catheter is configured to connect to a console (60) comprising the one-way flow element (71) in-line with the lumen (18) so that flow in a distal-to-proximal direction is allowed and flow in a proximal-to-distal direction is inhibited or prevented. 25 30

### Patentansprüche

1. Eine medizinische Vorrichtung, die Folgendes beinhaltet: 35  
einen Katheter (10) zum Isolieren und Ablassen von Luft aus einem übermäßig aufgeblähten Lungenkompartiment, wobei der Katheter (10) Folgendes beinhaltet: 40  
  
einen Katheterhauptteil (12) mit einem distalen Ende (14), einem proximalen Ende (16) und mindestens einem Lumen (18), das sich von dem distalen Ende (14) zu dem proximalen Ende (16) erstreckt, wobei mindestens ein distaler Abschnitt des Katheterhauptteils dazu angepasst ist, durch die Atemwege der Lunge vorgeschoben zu werden; 45  
ein expandierbares Okklusionselement (15), das in der Nähe des distalen Endes (14) des Katheterhauptteils angeordnet ist, wobei das Okklusionselement (15) dazu angepasst ist, in einem Atemweg expandiert zu werden, der das übermäßig aufgeblähte Lungenkompartiment speist, so dass, wenn das Okklusionselement (15) expandiert ist, der Zugang zu dem Kompartiment nur durch das Lumen (18) bereitgestellt 50 55

wird; und  
eine Einwege-Strömungsbaugruppe (70), die Folgendes beinhaltet:

- ein Einwege-Strömungselement (71), das dazu angepasst ist, innerhalb des Lumens (18) oder in Reihe mit dem Lumen angeordnet zu sein, sodass die Strömung in einer Richtung von distal nach proximal gestattet wird und die Strömung in einer Richtung von proximal nach distal behindert oder verhindert wird; und  
einen Strömungssensor (73), einen Drucksensor (74) und eine Ventilsteuereinrichtung (75);  
wobei der Strömungssensor (73) die Strömung überwacht, um den Beginn eines Inhalationszyklus zu detektieren, der Drucksensor (74) den Druck überwacht, um den Beginn eines Exhalationszyklus zu detektieren, und die Ventilsteuereinrichtung (75) das Einwege-Strömungselement am Beginn des Exhalationszyklus öffnet, um Luft aus dem übermäßig aufgeblähten Lungenkompartiment abzulassen, und das Einwege-Strömungselement am Beginn des Inhalationszyklus schließt, um ein erneutes Aufblähen des übermäßig aufgeblähten Lungenkompartiments zu verhindern.
2. Medizinische Vorrichtung nach Anspruch 1, wobei der Katheterhauptteil (12) eine Länge im Bereich von 20 cm bis 200 cm und einen Durchmesser in der Nähe des distalen Endes (14) im Bereich von 0,1 mm bis 10 mm aufweist.
3. Medizinische Vorrichtung nach Anspruch 1 oder 2, wobei das expandierbare Okklusionselement (15) ein aufblähbare Ballon, eine Manschette oder ein geflochtener Ballon ist.
4. Medizinische Vorrichtung nach einem der vorhergehenden Ansprüche, wobei das expandierbare Okklusionselement (15) eine Breite im Bereich von 1 mm bis 30 mm aufweist, wenn es vollständig expandiert ist.
5. Medizinische Vorrichtung nach einem der vorhergehenden Ansprüche, wobei das Einwege-Strömungselement (71) in dem Lumen angeordnet ist.
6. Medizinische Vorrichtung nach Anspruch 5, wobei das Einwege-Strömungselement (71) in der Nähe des distalen Endes des Katheterhauptteils angeordnet ist.
7. Medizinische Vorrichtung nach einem der Ansprüche 1 bis 4, die ferner eine Nabe (20) beinhaltet, die

an einem proximalen Ende des Katheterhauptteils angeordnet ist.

8. Medizinische Vorrichtung nach Anspruch 7, wobei ein zweites Einwege-Strömungselement in der Nabe (20) angeordnet ist. 5
9. Medizinische Vorrichtung nach Anspruch 7 oder 8, wobei die Nabe (20) entfernbar ist und in Reihe mit dem Lumen (18) befestigt werden kann. 10
10. Medizinische Vorrichtung zum Isolieren und Ablassen von Luft aus einem übermäßig aufgeblähten Lungenkompartiment nach Anspruch 1, wobei der Katheter dazu ausgelegt ist, mit einem Schaltpult (60) verbunden zu werden, welches das Einwege-Strömungselement (71) in Reihe mit dem Lumen (18) beinhaltet, sodass die Strömung in einer Richtung von distal nach proximal gestattet wird und die Strömung in einer Richtung von proximal nach distal behindert oder verhindert wird. 15  
20

#### Revendications

1. Appareil médical comprenant :  
un cathéter (10) pour isoler et dégonfler un compartiment de poumon hypergonflé, ledit cathéter (10) comprenant :

un corps de cathéter (12) ayant une extrémité distale (14), une extrémité proximale (16), et au moins une lumière (18) s'étendant de l'extrémité distale (14) à l'extrémité proximale (16), où au moins une partie distale du corps de cathéter est adaptée pour être avancée à travers les voies aériennes du poumon ;

un élément d'occlusion apte à s'élargir (15) disposé à proximité de l'extrémité distale (14) du corps de cathéter, ledit élément d'occlusion (15) étant adapté pour être élargi dans une voie aérienne qui alimente le compartiment de poumon hypergonflé de sorte que l'accès au compartiment soit fourni uniquement par la lumière (18) lorsque l'élément d'occlusion (15) est élargi ; et un ensemble d'écoulement unidirectionnel (70) comprenant :

un élément d'écoulement unidirectionnel (71) adapté pour être disposé au sein de la lumière (18) ou en ligne avec celle-ci de sorte qu'un écoulement dans un sens distal-à-proximal soit permis et un écoulement dans un sens proximal-à-distal soit entravé ou empêché ; et

un capteur d'écoulement (73), un capteur de pression (74) et un dispositif de commande de soupape (75) ;

où le capteur d'écoulement (73) surveille l'écoulement pour détecter le début d'un cycle d'inspiration, le capteur de pression (74) surveille la pression pour détecter le début d'un cycle d'expiration et le dispositif de commande de soupape (75) ouvre l'élément d'écoulement unidirectionnel au début du cycle d'expiration afin de dégonfler le compartiment de poumon hypergonflé et ferme l'élément d'écoulement unidirectionnel au début du cycle d'inspiration pour empêcher un regonflage du compartiment de poumon hypergonflé.

2. Appareil médical tel que dans la revendication 1, où le corps de cathéter (12) a une longueur dans la plage allant de 20 cm à 200 cm et un diamètre à proximité de l'extrémité distale (14) dans la plage allant de 0,1 mm à 10 mm. 15
3. Appareil médical tel que dans les revendications 1 ou 2, où l'élément d'occlusion apte à s'élargir (15) est un ballonnet tressé, un brassard ou un ballonnet gonflable. 20
4. Appareil médical tel que dans l'une quelconque des revendications précédentes, où l'élément d'occlusion apte à s'élargir (15) a une largeur dans la plage allant de 1 mm à 30 mm lorsqu'il est complètement élargi. 25
5. Appareil médical tel que dans l'une quelconque des revendications précédentes, où l'élément d'écoulement unidirectionnel (71) est disposé dans la lumière. 30
6. Appareil médical tel que dans la revendication 5, où l'élément d'écoulement unidirectionnel (71) est disposé à proximité de l'extrémité distale du corps de cathéter. 35
7. Appareil médical tel que dans l'une quelconque des revendications 1 à 4, comprenant en outre un embout (20) disposé sur une extrémité proximale du corps de cathéter. 40
8. Appareil médical tel que dans la revendication 7, où un deuxième élément d'écoulement unidirectionnel est disposé dans l'embout (20). 45
9. Appareil médical tel que dans la revendication 7 ou 8, où l'embout (20) est amovible et peut être attaché en ligne avec la lumière (18). 50
10. Appareil médical pour isoler et dégonfler un compartiment de poumon hypergonflé tel que dans la revendication 1, où le cathéter est configuré pour se connecter à une console (60) comprenant l'élément 55

d'écoulement unidirectionnel (71) en ligne avec la lumière (18) de sorte qu'un écoulement dans un sens distal-à-proximal soit permis et un écoulement dans un sens proximal-à-distal soit entravé ou empêché.

5

10

15

20

25

30

35

40

45

50

55

10

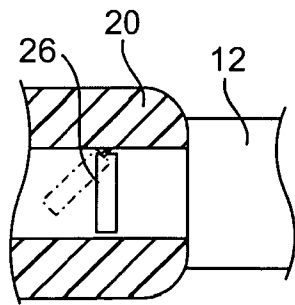
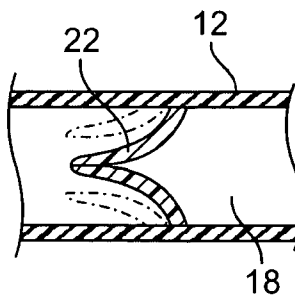
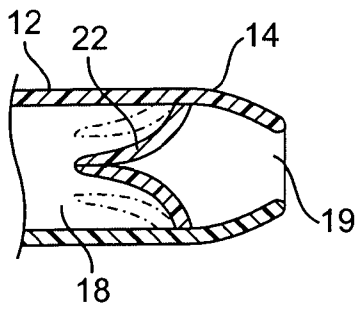
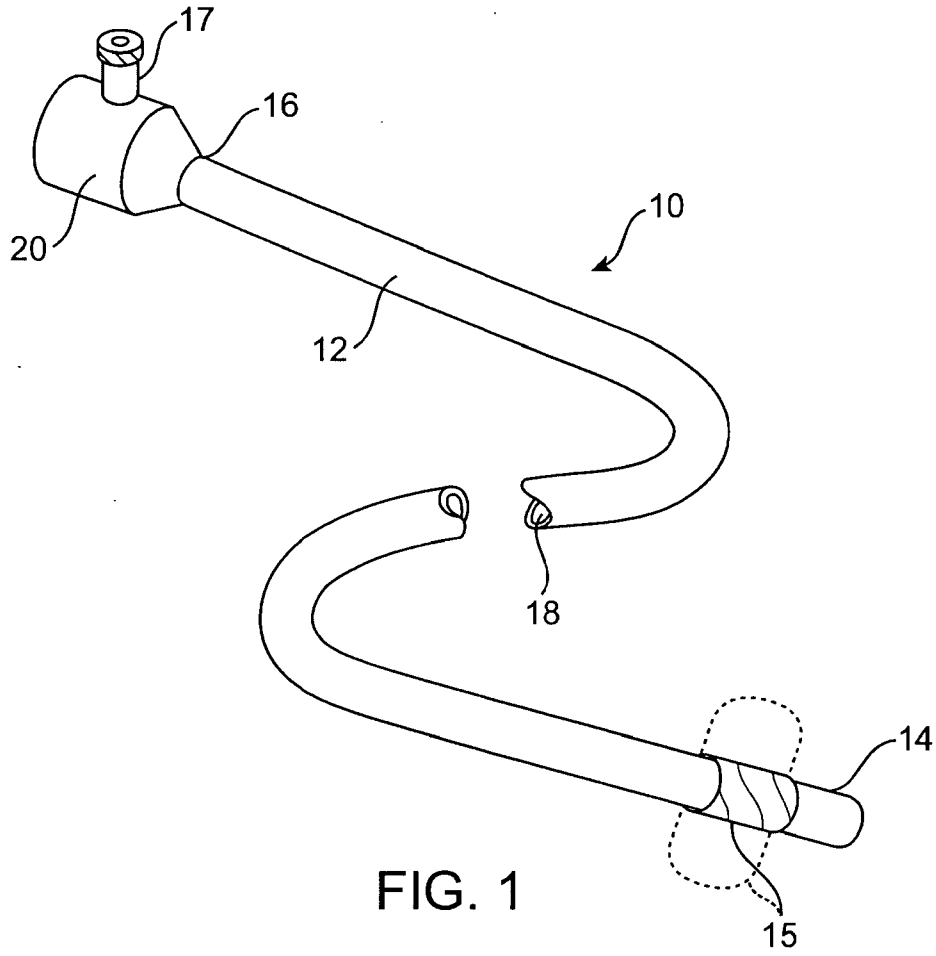

FIG. 2

FIG. 3

FIG. 4

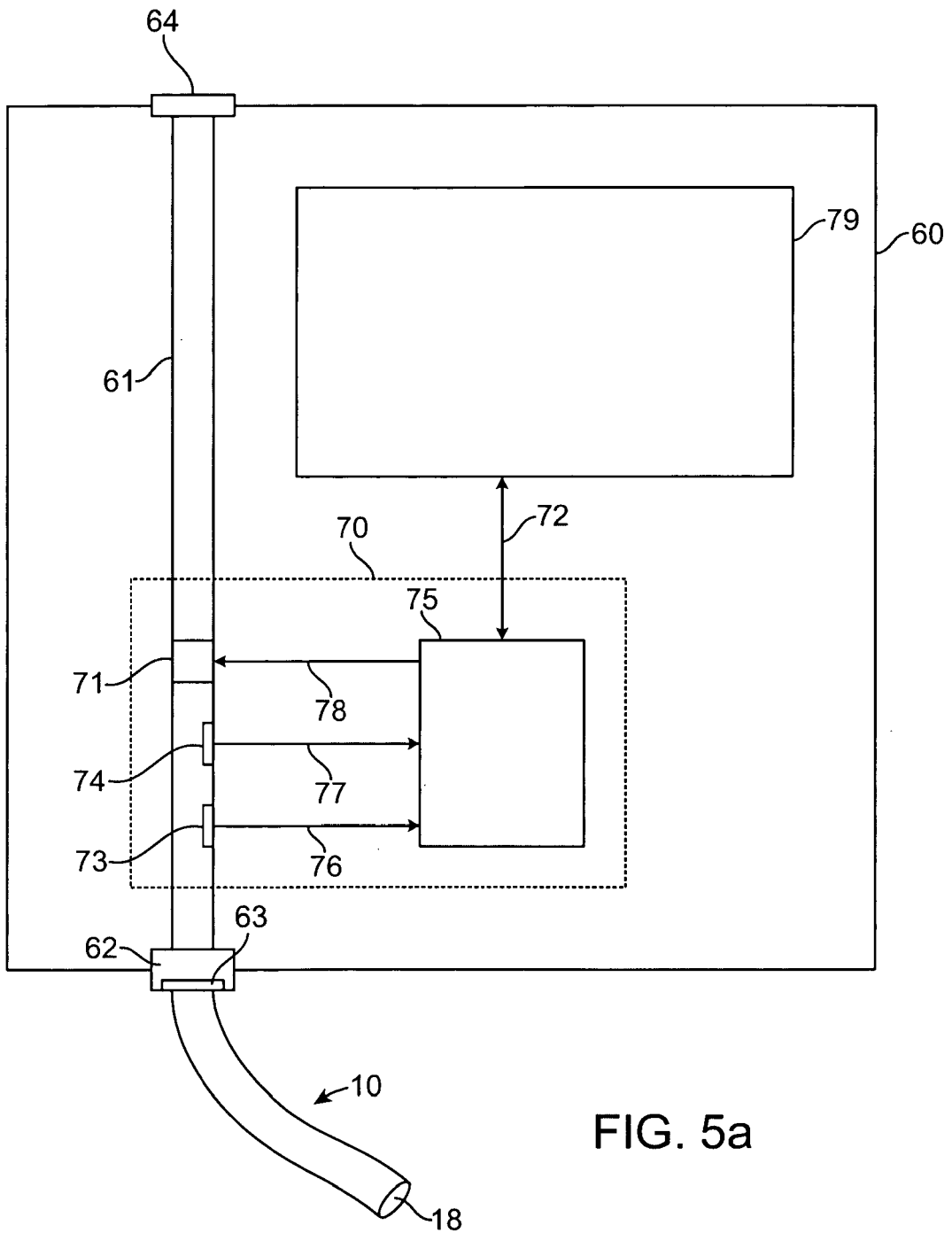

FIG. 5a

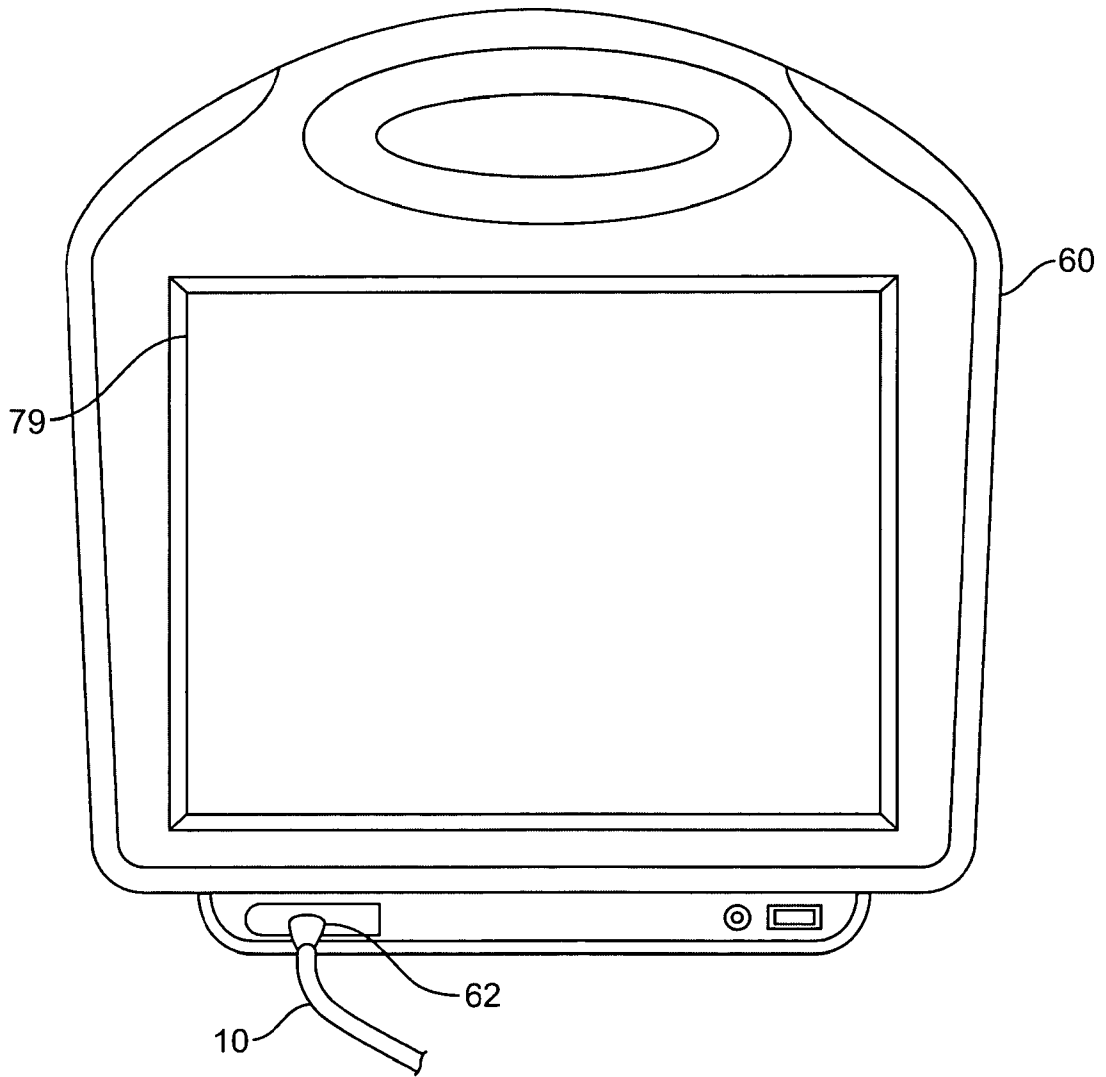

FIG. 5b

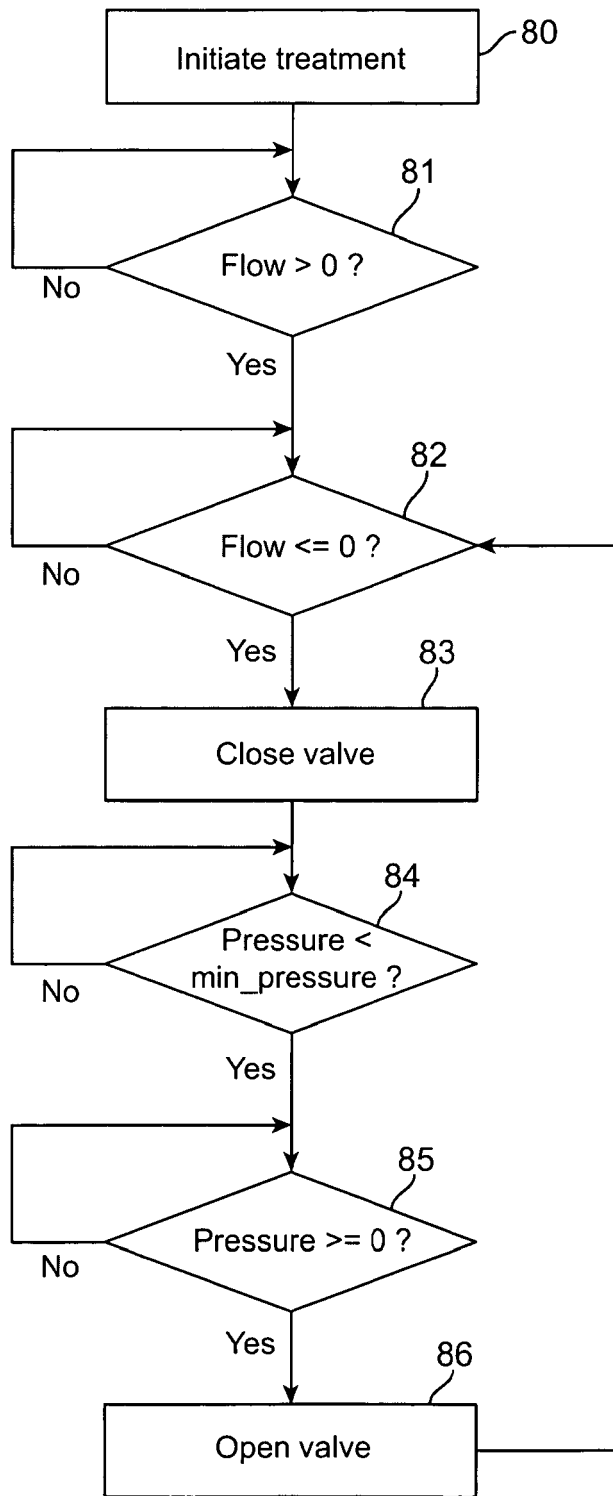

FIG. 6a

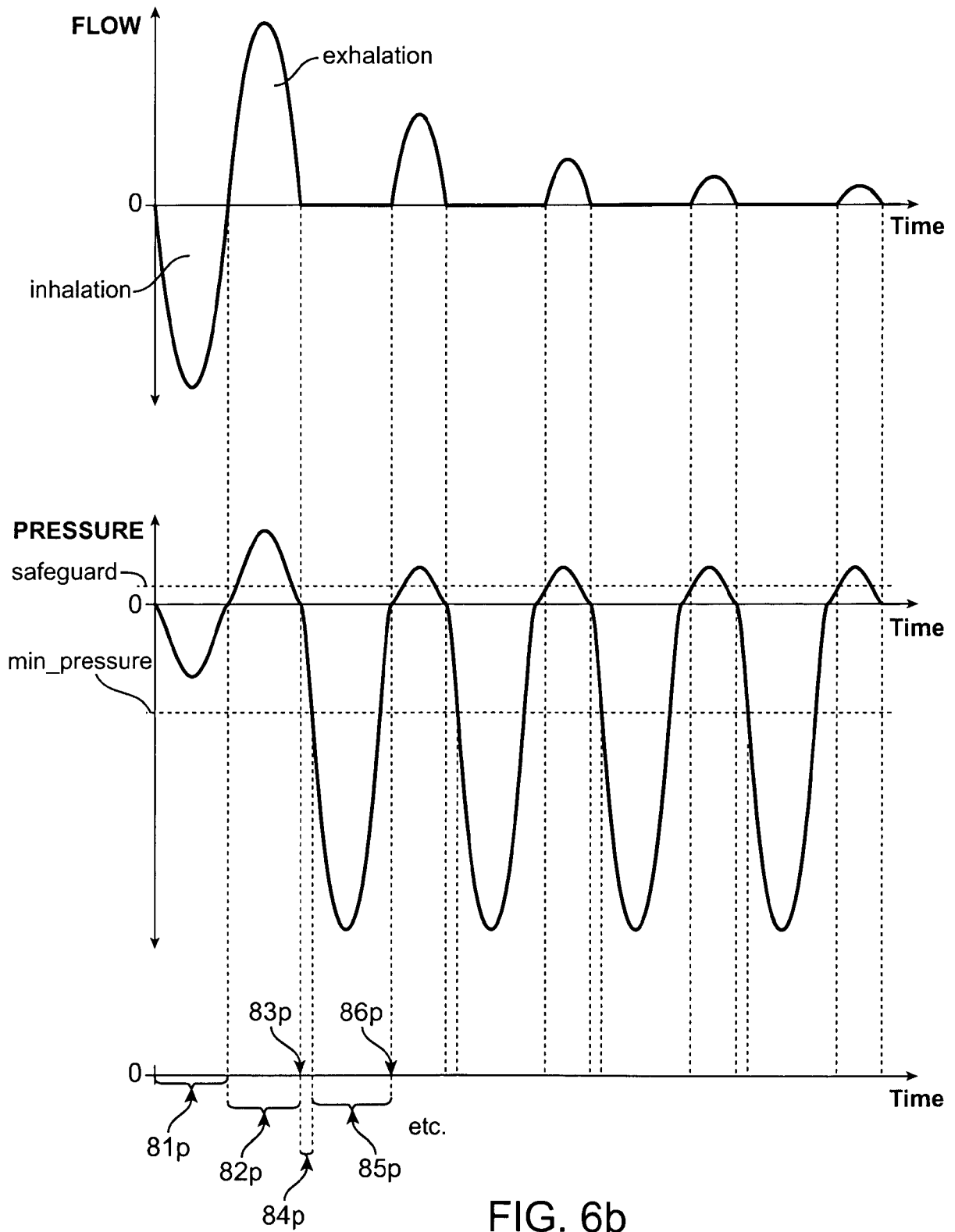

FIG. 6b

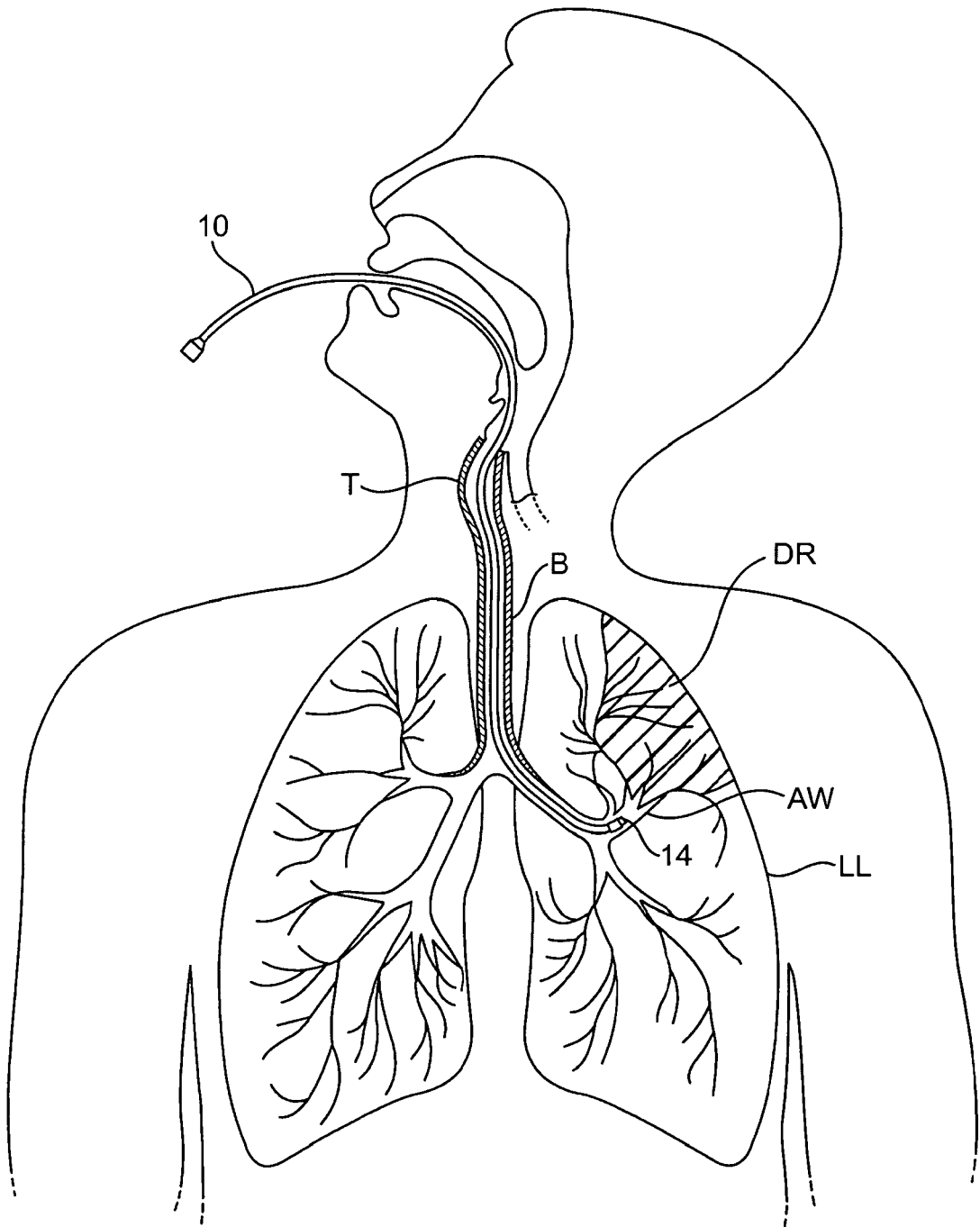

FIG. 7

EXHALATION FROM  
ISOLATED SEGMENT

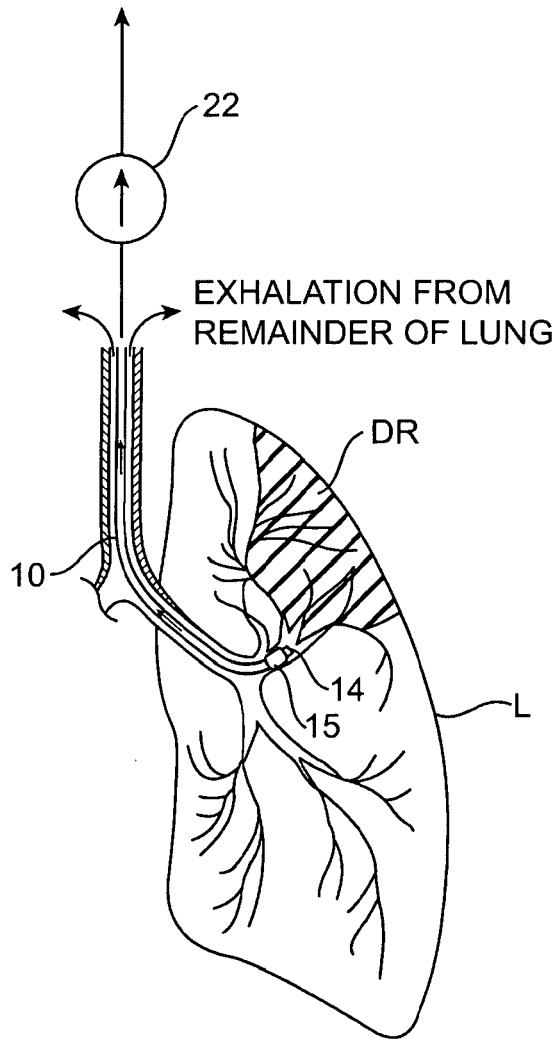

FIG. 8a

NO INHALATION TO  
ISOLATED LUNG SEGMENT

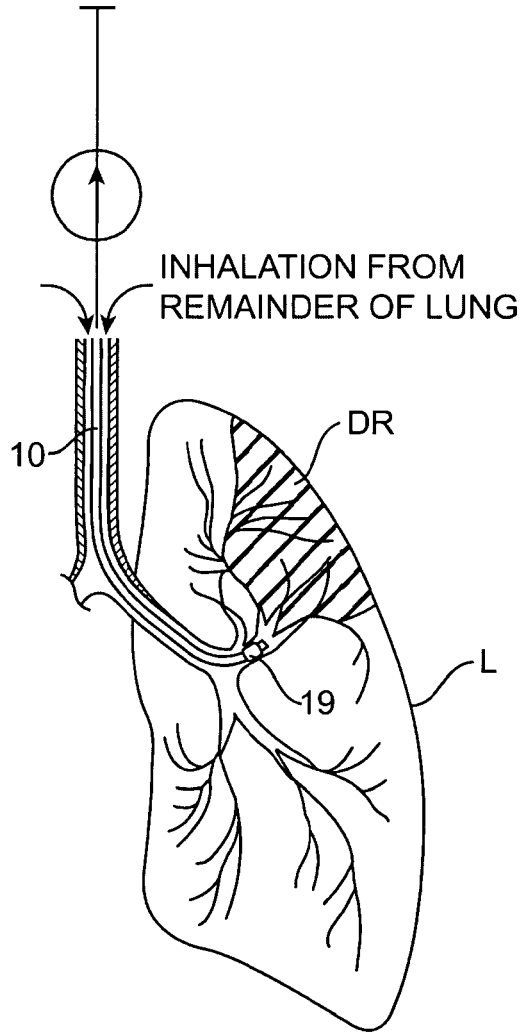

FIG. 8b

EXHALATION CEASES FROM  
ISOLATED LUNG SEGMENT

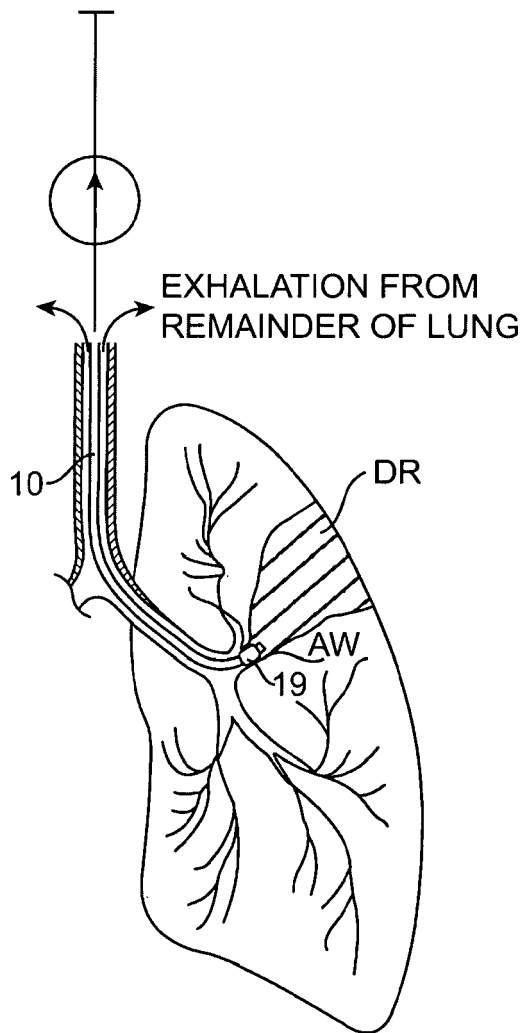

FIG. 8c

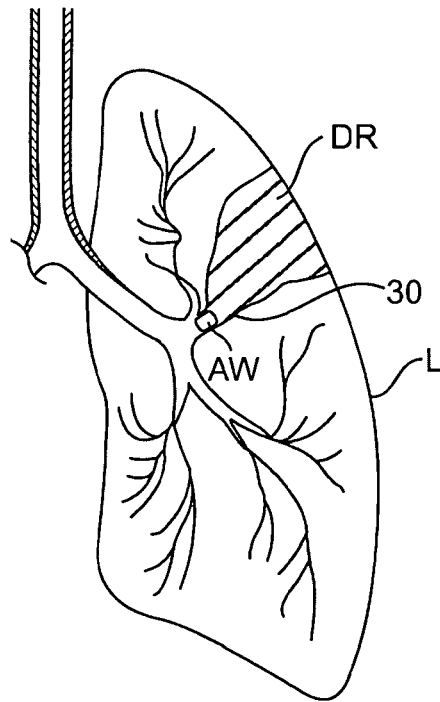

FIG. 8d

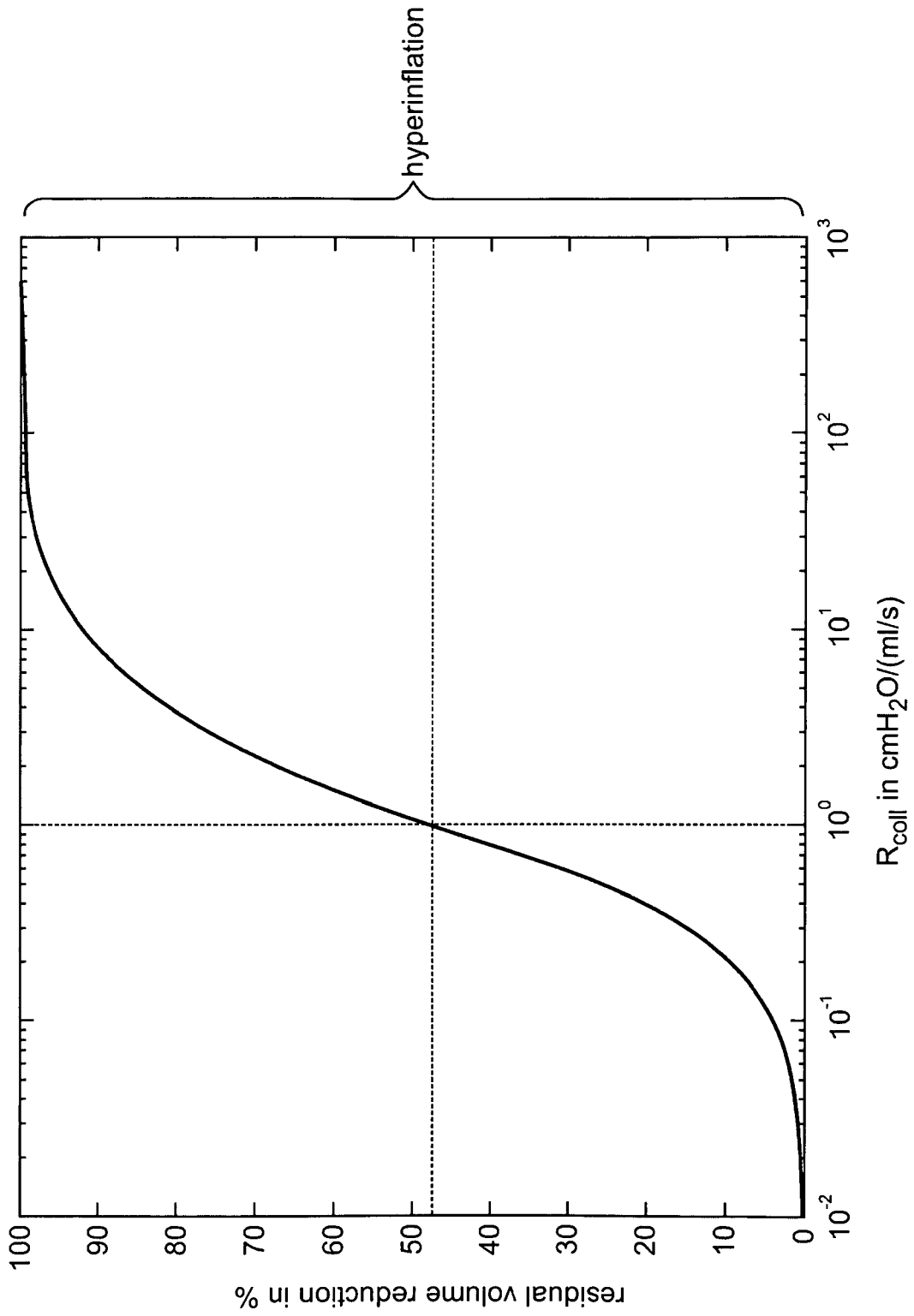

FIG. 9

**REFERENCES CITED IN THE DESCRIPTION**

*This list of references cited by the applicant is for the reader's convenience only. It does not form part of the European patent document. Even though great care has been taken in compiling the references, errors or omissions cannot be excluded and the EPO disclaims all liability in this regard.*

**Patent documents cited in the description**

- US 6258100 B [0005] [0008]
- US 6679264 B [0005] [0008]
- US 5972026 A [0008]
- US 6083255 A [0008]
- US 6287290 B [0008] [0043] [0045]
- US 6398775 B [0008] [0011] [0043]
- US 6527761 B [0008] [0043] [0045]
- US 6585639 B [0008]
- US 6709401 B [0008]
- US 6878141 B [0008]
- US 6997918 B [0008]
- US 20010051899 A [0008]
- US 20040016435 A [0008]
- US 20060264772 A [0009] [0018]
- US 20020169413 A [0010]
- EP 0982044 A [0012]
- US 11296951 B [0018]
- US 11550660 B [0018]
- US 20070142742 A [0018]
- US 11428762 B [0018]
- US 11684950 B [0019]
- US 60823734 B [0044]
- US 60828496 B [0044]

专利名称(译)	用于被动残余肺减容和功能性肺容量扩张的方法和装置		
公开(公告)号	<a href="#">EP2121091A2</a>	公开(公告)日	2009-11-25
申请号	EP2008732032	申请日	2008-03-12
申请(专利权)人(译)	PULMONX CORPORATION		
当前申请(专利权)人(译)	PULMONX CORPORATION		
[标]发明人	ALJURI NIKOLAI PERKINS RODNEY C		
发明人	ALJURI, NIKOLAI PERKINS, RODNEY C.		
IPC分类号	A61M16/00 A61B17/12 A61F2/958 A61B1/267 A61B5/00 A61B5/08 A61F2/04 A61M16/04 A61M16/20 A61M25/10		
CPC分类号	A61B17/12104 A61B17/12136 A61F2002/043 A61M25/10 A61M2025/1052 Y10T29/49826 A61B1 /2676 A61B5/0084 A61B5/08 A61B5/4836 A61M16/0003 A61M16/0434 A61M16/0436 A61M16/208 A61M2016/0027 A61M2016/003 A61M2202/0208 A61M2205/3334 A61M2207/10		
代理机构(译)	WORK, 伊利亚		
优先权	11/685008 2007-03-12 US		
其他公开文献	EP2121091A4 EP2121091B1		
外部链接	<a href="#">Espacenet</a>		

#### 摘要(译)

通过在供给肺隔室的气道中密封导管的远端来减少过度充气的肺隔室的体积。当患者呼气时，空气通过导管中的通道流出肺隔室。与导管相关联的单向流动元件防止空气在患者吸气时重新进入肺隔室。随着时间的推移，肺隔室周围区域的压力导致其随着空气体积减小而坍塌。残余体积减少有效地导致功能性肺容量扩张。可选地，可以密封肺隔室以永久地防止空气重新进入肺隔室。本发明还公开了一种导管，其尖端具有透明的闭塞元件，能够检查通过观察镜的肺通道。