



- (51) **International Patent Classification:**
A61B 5/117 (2006.01) A61B 5/00 (2006.01)
- (21) **International Application Number:**
PCT/US2017/046106
- (22) **International Filing Date:**
09 August 2017 (09.08.2017)
- (25) **Filing Language:** English
- (26) **Publication Language:** English
- (30) **Priority Data:**
15/232,884 10 August 2016 (10.08.2016) US
15/232,888 10 August 2016 (10.08.2016) US
15/232,894 10 August 2016 (10.08.2016) US
- (71) **Applicant:** ELWHA LLC [US/US]; 3150 139th Ave SE, Bellevue, Washington 98005-4046 (US).
- (72) **Inventor:** HYDE, Roderick A.; 9915 161st Ave NE, Redmond, Washington 98052 (US).
- (72) **Inventor:** KARE, Jordin T. (deceased).
- (72) **Inventors:** MCKNIGHT, Gary L.; 8548 NE 176th St., Bothell, Washington 98011 (US). PETROSKI, Robert C.; 1435 E John St., #405, Seattle, Washington 98112 (US).
- (74) **Agent:** MALASKA, Stephen L. et al.; 3150 139th Ave SE, Bellevue, Washington 98005-4046 (US).
- (81) **Designated States** (unless otherwise indicated, for every kind of national protection available): AE, AG, AL, AM, AO, AT, AU, AZ, BA, BB, BG, BH, BN, BR, BW, BY, BZ, CA, CH, CL, CN, CO, CR, CU, CZ, DE, DJ, DK, DM, DO, DZ, EC, EE, EG, ES, FI, GB, GD, GE, GH, GM, GT, HN, HR, HU, ID, IL, IN, IR, IS, JO, JP, KE, KG, KH, KN, KP, KR, KW, KZ, LA, LC, LK, LR, LS, LU, LY, MA, MD, ME, MG, MK, MN, MW, MX, MY, MZ, NA, NG, NI, NO, NZ, OM, PA, PE, PG, PH, PL, PT, QA, RO, RS, RU, RW, SA, SC, SD, SE, SG, SK, SL, SM, ST, SV, SY, TH, TJ, TM, TN, TR, TT, TZ, UA, UG, US, UZ, VC, VN, ZA, ZM, ZW.
- (84) **Designated States** (unless otherwise indicated, for every kind of regional protection available): ARIPO (BW, GH, GM, KE, LR, LS, MW, MZ, NA, RW, SD, SL, ST, SZ, TZ, UG, ZM, ZW), Eurasian (AM, AZ, BY, KG, KZ, RU, TJ, TM), European (AL, AT, BE, BG, CH, CY, CZ, DE, DK, EE, ES, FI, FR, GB, GR, HR, HU, IE, IS, IT, LT, LU, LV, MC, MK, MT, NL, NO, PL, PT, RO, RS, SE, SI, SK, SM, TR), OAPI (BF, BJ, CF, CG, CI, CM, GA, GN, GQ, GW, KM, ML, MR, NE, SN, TD, TG).

(54) **Title:** SYSTEMS AND METHODS FOR INDIVIDUAL IDENTIFICATION AND AUTHORIZATION UTILIZING CONFORMABLE ELECTRONICS

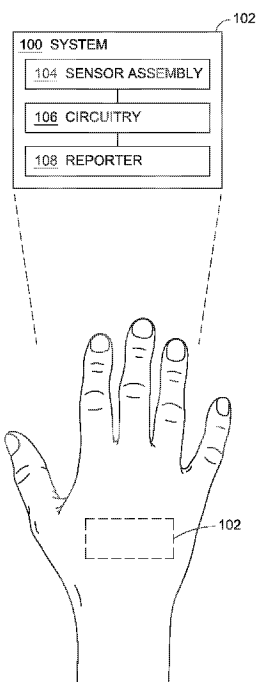

FIG. 1

(57) **Abstract:** A device embodiment includes, but is not limited to, a deformable substrate; a sensor assembly including one or more sensors configured to generate one or more identity sense signals associated with at least one physical characteristic of an individual subject; circuitry including an identity comparison module configured to compare the one or more identity sense signals to reference data indicative of one or more physical characteristics associated with an identity of at least one individual to determine whether the one or more identity sense signals correspond to the identity of the at least one individual, the circuitry including an authorization comparison module configured to compare at least one of the identity sense signals or the identity with one or more authorization parameters; and a reporter configured to generate one or more communication signals associated with at least one of the one or more identity sense signals or a comparison of at least one of the one or more identity sense signals with the one or more physical characteristics associated with the identity of the at least one individual or authorization parameters or the identity with the one or more authorization parameters.

WO 2018/031665 A1

Published:

— *with international search report (Art. 21(3))*

Systems and Methods for Individual Identification and Authorization Utilizing Conformable Electronics

5 All subject matter of the Priority Application(s) is incorporated herein by reference to the extent such subject matter is not inconsistent herewith.

SUMMARY

10 In an aspect, a device includes, but is not limited to, a deformable substrate configured to conform to a skin surface of a body portion of an individual subject; including one or more identity sensors configured to generate one or more identity sense signals associated with at least one physical characteristic of the individual subject; circuitry operably coupled to the sensor assembly and configured to receive the one or more identity sense signals associated with the at least one
15 physical characteristic of the individual subject, the circuitry including an identity comparison module configured to compare the one or more identity sense signals generated by the sensor assembly to reference data indicative of one or more physical characteristics associated with an identity of at least one individual to determine whether the one or more identity sense signals correspond to the
20 identity of the at least one individual, the circuitry including an authorization comparison module configured to compare at least one of the one or more identity sense signals, or the identity of the at least one individual with one or more authorization parameters; and a reporter operably coupled to the circuitry and configured to generate one or more communication signals responsive to
25 instruction by the circuitry, the one or more communication signals associated with a comparison of at least one of the one or more identity sense signals or a comparison of the one or more identity sense signals with the one or more physical characteristics associated with the identity of the at least one individual or authorization parameters or the identity of the at least one individual with the one
30 or more authorization parameters.

 In an aspect, a method includes, but is not limited to, generating one or more identity sense signals corresponding to an individual subject via an identification device having a deformable substrate configured to conform to a skin

surface of a body portion of the individual subject and having at least one sensor coupled to the deformable substrate, the one or more identity sense signals associated with at least one physical characteristic of the individual subject; comparing via circuitry the one or more identity sense signals generated by the sensor assembly to reference data indicative of one or more physical characteristics associated with an identity of at least one individual to determine whether the one or more identity sense signals correspond to the identity of the at least one individual; comparing via circuitry at least one of the one or more identity sense signals or the identity of the at least one individual with one or more authorization parameters; and reporting to an associated external device via a reporter one or more communication signals responsive to instruction by circuitry coupled with the sensor assembly, the one or more communication signals associated with at least one of the one or more identity sense signals or associated with a comparison of at least one of the one or more identity sense signals or the identity of the at least one individual with the one or more physical characteristics associated with the identity of the at least one individual or authorization parameters.

In an aspect, a system includes, but is not limited to, an identification device including, but not limited to, a deformable substrate configured to conform to a skin surface of a body portion of an individual subject; a sensor assembly coupled to the deformable substrate, the sensor assembly including one or more identity sensors configured to generate one or more identity sense signals associated with at least one physical characteristic of the individual subject; circuitry operably coupled to the sensor assembly and configured to receive the one or more identity sense signals associated with the at least one physical characteristic of the individual subject, the circuitry including a comparison module configured to compare the one or more identity sense signals generated by the sensor assembly to reference data indicative of one or more physical characteristics associated with an identity of at least one individual; and a reporter operably coupled to the circuitry and configured to generate one or more communication signals responsive to instruction by the circuitry, the one or more communication signals associated with at least one of the one or more identity sense signals or a comparison of the one or more identity sense signals with the

one or more physical characteristics associated with the identity of the at least one individual; and an external device operably coupled to the identification device, the external device including, but not limited to, a receiver configured to receive the one or more communication signals from the reporter of the identification device;
 5 and circuitry configured to compare the one or more communication signals with one or more authorization parameters associated with one or more users authorized to operate the external device.

The foregoing summary is illustrative only and is not intended to be in any way limiting. In addition to the illustrative aspects, embodiments, and features
 10 described above, further aspects, embodiments, and features will become apparent by reference to the drawings and the following detailed description.

BRIEF DESCRIPTION OF THE FIGURES

- 15 **FIG. 1** is a schematic of a system for identification of an individual using conformable electronics.
- FIG. 2** is a schematic of an embodiment of a system such as shown in FIG. 1.
- FIG. 3** is a schematic of an embodiment of a system such as shown in FIG. 1.
- FIG. 4** is a schematic of an embodiment of a system such as shown in FIG. 1.
- 20 **FIG. 5** is a schematic of an embodiment of a system such as shown in FIG. 1.
- FIG. 6** is a schematic of an embodiment of a system such as shown in FIG. 1.
- 25 **FIG. 7** is a schematic of an embodiment of a system such as shown in FIG. 1.
- FIG. 8** is a schematic of an embodiment of a system such as shown in FIG. 1.
- FIG. 9** is a schematic of an embodiment of a system such as shown in FIG. 1.
- 30 **FIG. 10** is a schematic of a system for identification of an individual and authorization of an identified individual using conformable electronics.

FIG. 11 is a schematic of an embodiment of a system such as shown in FIG. 10.

FIG. 12 is a schematic of an embodiment of a system such as shown in FIGS. 1 and 10.

5 **FIG. 13** is a schematic of an embodiment of a system such as shown in FIGS. 1 and 10.

FIG. 14 is a schematic of an embodiment of a system such as shown in FIGS. 1 and 10.

10 **FIG. 15** is a schematic of an embodiment of a system such as shown in FIGS. 1 and 10.

FIG. 16 is a flowchart of a method of identifying an individual using conformable electronics positioned on the individual.

FIG. 17 is a flowchart of a method of identifying and authorizing an individual using conformable electronics positioned on the individual.

15 **FIG. 18** is a flowchart of a method of adjusting an adhesive state of an adhesive responsive to identification of an individual using conformable electronics.

FIG. 19 is a flowchart of a method of adjusting an adhesive state of an adhesive responsive to identification of an individual using conformable
20 electronics.

DETAILED DESCRIPTION

In the following detailed description, reference is made to the accompanying drawings, which form a part hereof. In the drawings, similar
25 symbols typically identify similar components, unless context dictates otherwise. The illustrative embodiments described in the detailed description, drawings, and claims are not meant to be limiting. Other embodiments may be utilized, and other changes may be made, without departing from the spirit or scope of the subject matter presented here.

30 Systems, devices, and methods are described for identification and authorization of individuals using conformable electronics for aspects of the identification and authorization processes. Such systems can be applied to,

maintained against, or otherwise be in contact with, a skin surface of a body portion of an individual to evaluate one or more physical characteristics of the individual, including but not limited to, skin topography features (e.g., pattern of skin surface, follicle pattern, pore pattern, pigmentation, etc.), vascular properties or layouts, electric current pattern (e.g., photovoltaic current pattern), or skin resistivity measurement. The physical characteristics can be compared against reference data that include physical characteristics of known identities to determine whether the measured physical characteristics correspond to the reference physical characteristics, whereby the particular identity can be determined or inferred. In an embodiment, the identification can disable or enable operation or functionality of one or more components of the system. For example, where an individual does not match an identity that corresponds to any reference identity, is identified but is not in a state suitable for operation of a device (e.g., intoxicated, stressed, etc.), or is identified but not authorized to use a particular device or system, the system can disable a power connection to one or more components of the system, thereby preventing their use. Where an individual is identified, the system can enable a power connection to one or more components of the system (e.g., sensors, reporters, etc.), thereby enabling or activating their use. In an embodiment, the identification can lead to subsequent authorization, such as authorization reported to or processed by an external device. Such authorization can permit operation of the external device or associated device or system by the identified and authorized individual, or can permit an external device or associated device or system to be aware of the identity of a particular user.

In an embodiment, the systems described herein can be configured to adhere to a skin surface of a body portion of the individual, which can facilitate ease of use and avoid unintentional misplacement of the identification and/or authorization system. In an embodiment, such systems can be configured to disable the functionality of one or more components when removed from the skin surface, or otherwise become difficult to remove intact, such as to avoid transfer of the system to another user. In an embodiment, the systems described herein can be removable and reusable.

In an embodiment, the systems described herein can sense a combination of skin properties to confirm that the host body portion is associated with an individual that is present and in good health, which can avoid security issues associated with identification and/or authorization systems that utilize biometric or other identification/authorization protocols that can be circumvented by removal of a body portion or embedded tag used for identification/authorization.

In an embodiment, the systems described herein employ one or more identity sensors configured to monitor or sense at least one physical characteristic of the individual. The identity sensor can include, but is not limited to, an optical sensor, an electromagnetic sensor, an impedance sensor, a capacitive sensor, an electrophysiological sensor, a plethysmographic sensor, a resistive sensor, a biosensor, or a chemical sensor. The identity sensors are coupled to circuitry configured to compare the output of the identity sensors to reference data to determine whether the output of the identity sensors corresponds to an identity of a known individual. The systems can also include one or more of physiological sensors, proximity sensors, contact sensors, pressure sensors, or temperature sensors to facilitate operation of the system, to provide contextual data in combination with the output from the identity sensors, to toggle activation/deactivation of one or more components of the system, or the like.

In an embodiment, the systems described herein employ a reporter configured to generate one or more communication signals responsive to instruction by the circuitry. For example, the reporter can convey information via the one or more communication signals directed to the output of the sensors, a comparison of the output of the sensors with reference data (e.g., reference identity data or reference physical characteristics), identity information of the individual on which the system is positioned, authorization information (e.g., whether or not an identified individual is authorized, such as authorized to operate a particular device, machine, electronic device, etc.), or the like.

In an embodiment, shown in FIG. 1, a system (or device) 100 is configured to evaluate one or more physical characteristics of an individual on which the system 100 is positioned to facilitate identification of the individual. The system 100 includes a deformable substrate 102, a sensor assembly 104, circuitry 106, and a reporter 108. The deformable substrate 102 is configured to conform to a

contour of a body portion of an individual subject (e.g., the curvature of a limb). For example, the deformable substrate 102 can comprise a deformable (e.g., conformable, flexible, stretchable, etc.) material configured to interface with, and conform to, the body portion. The body portion is shown in FIG. 1 as a hand, however the system 100 can be positioned on the skin surface of any body portion, including but not limited to, an arm, an elbow, a wrist, a hand, a finger, a leg, a knee, an ankle, a foot, a toe, a facial region, a neck region, a torso region, or the like. The pliable nature of the deformable substrate 102 (e.g., flexibility and stretchability) facilitates interaction/interfaces with the body portion, which includes a generally low-modulus and deformable natural skin surface. In an embodiment, the deformable substrate 102 can include one or more of a stretchable/flexible fabric, paper, or polymer (e.g., a natural or synthetic elastomeric polymer, polyimide, polyvinyl, an organic polymer such as PDMS, xylylene, parylene, an inorganic polymer, a biopolymer, a composite material, or any combination thereof), a film (e.g., a hydrocolloid film), a membrane (e.g., a nanomembrane, such as a silicon nanomembrane), a gas-permeable elastomeric sheet, or other deformable (e.g., stretchable, flexible, pliable) material. The deformable substrate 102 can be positioned in proximity with the skin surface according to various mechanisms including, but not limited to, affixed to the skin via an adhesive material, held in place by an external pressure, such as pressure provided by a material wrapped around or about a body portion (e.g., a fabric, a garment, a glove, a bandage, etc.), affixed in a textile, fabric, garment, accessory (e.g., a glove, a sock, a finger cot, etc.), or so forth.

In embodiments, the system 100 includes at least one flexible or stretchable electronic component. For example, at least one of the sensor assembly 104 (e.g., identity sensors as described herein), the circuitry 106, or the reporter 108 can include or be formed of flexible or stretchable electronics coupled to the deformable substrate 102. For example, interconnects (not illustrated) between these components or within the circuitry can include or be formed of flexible or stretchable electronics (e.g., serpentine conducting tracings allowing for stretchable interconnects) and coupled to the deformable substrate 102. For example, a power source (e.g., power supply 600 described herein), can include or be formed of flexible or stretchable electronics and be coupled to the

deformable substrate 102. In embodiments, the at least one flexible or stretchable electronic component includes at least one of a wavy, bent, mesh (e.g., open mesh), buckled, or serpentine geometry. In embodiments, the at least one flexible or stretchable electronic component includes at least one nanowire, at least one
5 nanoribbon, or at least one nanomembrane. For example, the system 100 can include one or more multifunctional electronic units comprising a stretchable/flexible system including a sensor assembly (e.g., sensor assembly 104), reporter (e.g., reporter 108), and power source (e.g., power supply 600) in communication via associated circuitry (e.g., circuitry 106), including
10 interconnects, residing in or on a deformable substrate (e.g., deformable substrate 102).

In embodiments, the system 100 can include at least one ultrathin electronic component. For example, an ultrathin (e.g., less than 20 micrometers) electronic component can include a thinned wafer (e.g., thinned silicon wafer
15 bonded to a polymer substrate), an ultrathin chip, or the like. For example, ultrathin circuitry can include conductive layers formed on a deformable substrate (e.g., deformable substrate 102) such as parylene by evaporation deposition with UV lithography and etching. For example, at least one of the sensory assembly 104, the circuitry 106, or the reporter 108 can include ultrathin electronics.

20 In embodiments, the system 100 can include at least one electrically conductive thread, yarn, or textile. For example, the sensory assembly 104, the circuitry 106, or the reporter 108 can include at least one electrically conductive thread or yarn. Electrically conductive threads, yarns, or textiles can be configured to provide sufficient current to induce at least one of a wired or wireless coupling,
25 e.g., between electronic components. For example, electronically conductive threads, yarns, or textiles may form circuitry 106 configured to function in communication between one or more sensor assemblies 106, one or more reporters 108, or other circuitry 106. For example, electronically conductive threads, yarns, or textiles may form at least a portion of circuitry 106 configured to
30 function in communication between a plurality of multifunctional electronic units each comprising one or more sensor assemblies 106, one or more reporters 108, and circuitry 106. Electrically conductive fibers, threads, and yarns can include a metallic material, semi-metallic material, semi-insulative material, semi-conductive

material (e.g., silicon and a gallium arsenide), or transparent conductive material (e.g., an indium-tin-oxide (ITO) material). Electrical threads or yarns can be embedded in textiles using weaving, knitting or embroidery, for example, or can be attached using nonwoven production techniques such as adhesion. For
5 example, electrically conductive yarns having curved configuration can be attached to an elastic textile (e.g., by sewing or by adhesion) and can form all or part of a sensor assembly 104 that measures one or more physical characteristics of an individual, e.g., as the curved configuration is altered, such as due to particular skin topography or the like.

10 The sensor assembly 104 is coupled to the deformable substrate 102 and is positioned to generate one or more sense signals associated with a physical characteristic of the individual subject on whom the system 100 is positioned. For example, as shown in FIG. 2, the sensor assembly 104 includes one or more identity sensors 200 configured to generate one or more identity sense signals
15 associated with at least one physical characteristic of the individual subject. The identity sensor 200 can sense the physical characteristic to provide a basis for identification of the individual subject, or to provide an indication that the individual subject cannot be readily identified based on the observed physical characteristics. The identity sensor 200 can include, but is not limited to, one or
20 more of an optical sensor 202, an electromagnetic sensor 204, an impedance sensor 206, a capacitive sensor 208, an electrophysiological sensor 210, a plethysmographic sensor 212, a resistive sensor 214, a biosensor 216, or a chemical sensor 218. The identity sensor 200 can generate the one or more identity sense signals based on measurement or sensing of one more physical
25 characteristics of the individual subject, where the one or physical characteristics can include but are not limited to, skin topography features (e.g., pattern of skin surface, follicle pattern, pore pattern, pigmentation, etc.), vascular properties or layouts (e.g., arterial patterns, properties, or layouts; vein patterns, properties, or layouts; etc.), electric current pattern (e.g., photovoltaic current pattern), or skin
30 resistivity measurement. For example, as shown in FIG. 3, the system 100 can be positioned on a skin surface of a body portion (shown as a top surface of a hand in FIG. 3), where the system 100 can detect via the identity sensor 200 one or more of a follicle pattern 300, a pore pattern 302, a skin pigmentation or distinctive

skin mark 304, or a vascular pattern or layout 306. The identity sensor 200 can then generate one or more identity sense signals based on the structure of the particular sensor(s) of the sensor assembly 104 (e.g., optical sensor 202, electromagnetic sensor 204, impedance sensor 206, etc.), where such signals will correspond to the measured or sensed physical characteristics to facilitate in analysis of whether the identity of the individual subject can be determined. In an embodiment, the optical sensor 202 includes one or more optoelectronics generate the one or more identity sense signals based on measurement or sensing of one more physical characteristics of the individual subject. For example, the optoelectronics can include, but are not limited to, one or more polymer light-emitting diodes (PLEDs), one or more organic photodetectors (OPDs), or combinations thereof. In an embodiment, the optoelectronics include a plurality of polymer light-emitting diodes (PLEDs) configured to emit light of differing wavelengths (e.g., green, red, blue, etc.), which in combination with one or more organic photodetectors (e.g., having an active layer of poly(3-hexylthiophene) (P3HT):(6,6)-phenyl-C61-butyric acid methyl ester (PCBM)) are arranged as an ultraflexible reflective pulse oximeter.

Chemical sensors and biosensors (e.g., chemical sensor 218 and biosensor 216) can include aspects of physiological sensors, such that each of chemical sensors and biosensors can detect certain physiological conditions or parameters. For example, without limitation, a chemical sensor can detect a chemical signature of an analyte, for example an analyte of a physiological origin (e.g., a cellular compound, a secreted compound such as an antibody or a cytokine, or a metabolite) or an analyte of an exogenous origin (e.g., an ingested, inhaled, or topical substance, such as a drug, or a tagging or labeling compound). Examples of chemical sensors include, but are not limited to, sensors having recognition elements, electronic chip sensors, microbalance sensors, and near infrared spectrometers. A biosensor can detect a biochemical or biological element. Biosensors include, for example but are not limited to, sensors having a biological recognition element able to bind an analyte of interest (e.g., an aptamer-based microcantilever) and sensors utilizing an enzyme with recognition and reaction properties. In an embodiment, chemical sensors or biosensors can include molecular sensor or nanosensor aspects.

The sensor assembly 104 can be structured relative to the deformable substrate 102 such that at least a portion of the sensor assembly 104 is embedded within the deformable substrate 102, affixed to the deformable substrate 102, residing on the deformable substrate 102, printed directly onto the deformable substrate 102, or a combination thereof. For example, at least a portion of an identity sensor 200 can be embedded within the deformable substrate 102, can be affixed to the deformable substrate 102, can reside on the deformable substrate 102, can be directly printed on the deformable substrate 102, or a combination thereof. In an embodiment, the deformable substrate 102 can include one or more of a stretchable/flexible fabric, an elastomeric polymer, a hydrocolloid film, a membrane (e.g., a nanomembrane, such as a silicon nanomembrane), a gas-permeable elastomeric sheet, or other conformable material. In an embodiment, at least one of the sensor assembly 104, the circuitry 106, or the reporter 108 resides on the deformable substrate 102, such as residing on at least a portion of one or more of a stretchable/flexible fabric, an elastomeric polymer, a hydrocolloid film, a membrane (e.g., a nanomembrane, such as a silicon nanomembrane), a gas-permeable elastomeric sheet, or other conformable material. For example, at least a portion of at least one of the sensor assembly 104, the circuitry 106, or the reporter 108 can be printed directly onto at least a portion of the deformable substrate 102. In an embodiment, at least one of the sensor assembly 104, the circuitry 106, or the reporter 108 is embedded within the deformable substrate 102, such as embedded within at least a portion of one or more of a stretchable/flexible fabric, an elastomeric polymer, a hydrocolloid film, a membrane (e.g., a nanomembrane, such as a silicon nanomembrane), a gas-permeable elastomeric sheet, or other conformable material.

The circuitry 106 is configured to receive one or more identity sense signals (e.g., from the sensor assembly 104) associated with one or more physical characteristics of the individual subject on which the system 100 is positioned, and can provide analysis of the one or more identity sense signals. For example, in an embodiment, the circuitry 106 is operably coupled to the sensor assembly 104 such that the circuitry 106 is configured to receive the one or more identity sense signals from the one or more identity sensors 200 of the sensor assembly 104. In an embodiment, shown in FIG. 4, the circuitry 106 includes a comparison module

400 configured to compare the one or more identity sense signals generated by the sensor assembly 104 to reference data indicative of one or more physical characteristics associated with an identity of at least one individual to determine whether the one or more identity signals correspond to the identity of the at least
5 one individual. In an embodiment, the reference data is stored in a computer memory device 402 which can include, but is not limited to, random-access memory (RAM), read-only memory (ROM), electrically erasable programmable read-only memory (EEPROM), flash memory, or other memory technology, CD-ROM, digital versatile disks (DVD), or other optical disk storage, magnetic
10 cassettes, magnetic tape, magnetic disk storage, or other magnetic storage devices, or any other medium which can be used to store the desired information maintained by the comparison module 400 and which can be accessed by the circuitry 106 or other associated accessing device.

The circuitry 106 includes components to process the one or more sense
15 signals from the sensor assembly 104 and to provide instruction to the reporter 108 to generate one or more communication signals associated with the one or more identity sense signals, a comparison of the one or more identity sense signals with the one or more physical characteristics from reference data indicative with an identity of a particular individual, determinations made by the
20 circuitry 106, or other information. For example, the circuitry 106 can include a microprocessor, a central processing unit (CPU), a digital signal processor (DSP), an application-specific integrated circuit (ASIC), a field programmable gate entry (FPGA), or the like, or any combinations thereof, and can include discrete digital or analog circuit elements or electronics, or combinations thereof. In an
25 embodiment, the circuitry 106 includes one or more ASICs having a plurality of predefined logic components. In an embodiment, the circuitry 106 includes one or more FPGAs having a plurality of programmable logic commands. The computer memory device can be integrated with the system 100, can be associated with an external device and accessible by the system 100 through wireless or wired
30 communication protocols, or a combination thereof. For example, the reference data can be stored by the computer memory 702 coupled to the deformable substrate 102 of the system 100, can be accessible by the circuitry 106 via wireless means, or can be available to the circuitry 106 through another method,

such as through a remote network, a cloud network, and so forth. In an embodiment, the circuitry 106 includes a receiver 404 or transceiver 406 (e.g., antenna, etc.) to receive the reference data information or other information (e.g., correspondence threshold information, programming information) to facilitate
5 operation or control of the system 100 through wireless or wired communication protocols. For example, the receiver 404 can receive one or more communication signals from an external device associated with but not limited to, control programming, authorization parameters, reference data, or a query (e.g., a query to transmit information from the system 100 to the external device, a query to
10 begin sensing of identity sense signals via the sensor assembly 104, etc.). In embodiments, the circuitry 106 can also include a transmitter 408 or transceiver (e.g., antenna, etc.) to send information amongst components of the system 100 or to components external the system, such as to communicate with an external device (e.g., external device 800 described herein). Such communication can
15 include, for example, indications that the circuitry 106 is accessing one or more databases or memory devices storing reference or programming data, computational protocols, system updates, or the like.

The reference data includes data indicative of one or more physical characteristics associated with an identity of at least one individual. For example,
20 the reference data can include, but is not limited to, a skin topography feature associated with an identity of an individual, a skin surface pattern associated with an identity of an individual, a follicle pattern associated with an identity of an individual, a pore pattern associated with an identity of an individual, a pigmentation pattern or characteristic associated with an identity of an individual,
25 a vascular layout associated with an identity of an individual, an electric current pattern associated with an identity of an individual, a photovoltaic current pattern associated with an identity of an individual, a skin resistivity measurement associated with an identity of an individual, or the like. For example, the reference data can include one or more physical characteristics associated with a first
30 person/individual, one or more physical characteristics associated with a second person/individual, one or more physical characteristics associated with a third person/individual, and so on. The circuitry 106 is configured to compare the identity sense signals from the sensor assembly 104 to the reference data, such

that when the comparison is at or exceeds a threshold correspondence (e.g., within a predetermined confidence interval), the identity of the person/individual stored by the reference data can be attributed to the individual on which the system 100 is positioned. For example, if the reference data includes physical
5 characteristic information for each of Bob, Jan, and Joe, the circuitry 106 can compare the identity sense signals from the sensor assembly 104 to determine whether the identity sense signals would correspond to the physical characteristic information of Bob, Jan, or Joe.

The circuitry 106 can coordinate operations of the system 100 based on
10 analysis of the one or more identity sense signals, which can include but is not limited to, enabling or disabling certain operations or components of the system 100 based on whether the individual subject can be identified via the one or more identity sense signals. For example, in an embodiment, the circuitry 106 is configured to disable at least one component of the system 100 responsive to a
15 correspondence between the one or more identity sense signals and the one or more physical characteristics associated with the identity of the at least one individual being below a threshold correspondence. The correspondence between the one or more identity sense signals and the one or more physical characteristics associated with the identity of the at least one individual can
20 include a comparison by the circuitry 106 between the one or more identity sense signals and the one or more physical characteristics provided in the reference data (e.g., which can be linked or associated with certain identified individuals). As such, the circuitry 106 can disable functionality of a component of the system 100 where the individual subject on which the system 100 is positioned cannot be
25 readily identified based on the comparison made by the circuitry 106. For example, in an embodiment, the circuitry 106 is configured to disable a power connection to the sensor assembly 104 responsive to the correspondence between the one or more identity sense signals and the one or more physical characteristics associated with the identity of the at least one individual being
30 below the threshold correspondence. In an embodiment, the circuitry 106 is configured to disable a power connection to the reporter 108 responsive to the correspondence between the one or more identity sense signals and the one or more physical characteristics associated with the identity of the at least one

individual being below the threshold correspondence. For example, in an embodiment, shown in FIG. 5, the circuitry 106 can include, or can be operably coupled to, a switch structure 500 switchable between an active configuration and an inactivate configuration responsive to control by the circuitry 106. The switch
5 structure 500 can automatically disable, or can continue to disable, a power connection to one or more of the sensor assembly 104 or the reporter 108 (e.g., by providing a break in an electrical circuit providing power to the sensor assembly 104 or the reporter 108) when the individual subject on which the system 100 is positioned cannot be identified by the one or more identity sense
10 signals, causing the circuitry 106 to manipulate the switch structure 500 to the inactive configuration, or causing the circuitry 106 to maintain the inactive configuration. Thus, when the individual subject cannot be identified, the individual subject would be precluded from operating the sensor assembly 104 or the reporter 108.

15 The circuitry 106 can be configured to permit operation of at least one component of the system 100 responsive to a correspondence between the one or more identity sense signals and the one or more physical characteristics associated with the identity of the at least one individual being at or above a threshold correspondence. The correspondence between the one or more identity
20 sense signals and the one or more physical characteristics associated with the identity of the at least one individual can include a comparison by the circuitry 106 between the one or more identity sense signals and the one or more physical characteristics provided in the reference data (e.g., which can be linked or associated with certain identified individuals). As such, the circuitry 106 can
25 enable functionality of a component of the system 100 where the individual subject on which the system 100 is positioned can be identified (e.g., within the threshold correspondence) based on the comparison made by the circuitry 106. For example, in an embodiment, the circuitry 106 is configured to activate a power connection to the sensor assembly 104 responsive to the correspondence
30 between the one or more identity sense signals and the one or more physical characteristics associated with the identity of the at least one individual being at least at the threshold correspondence. In an embodiment, the circuitry 106 is configured to activate a power connection to the reporter 108 responsive to the

correspondence between the one or more identity sense signals and the one or more physical characteristics associated with the identity of the at least one individual being at least at the threshold correspondence. For example, the switch structure 500 can automatically activate, or can continue to support, a power connection to one or more of the sensor assembly 104 or the reporter 108 (e.g., by closing a break in an electrical circuit providing power to the sensor assembly 104 or the reporter 108, by maintaining the operability of the electrical circuit providing power to the sensor assembly 104 or the reporter 108, etc.) when the individual subject on which the system 100 is positioned can be identified by the one or more identity sense signals, causing the circuitry 106 to manipulate the switch structure 500 to the active configuration, causing the circuitry to maintain the switch structure 500 in the active configuration, or the like. Thus, when the individual subject can be identified, the individual subject can operate the sensor assembly 104 or the reporter 108, the system 100 can maintain functionality, etc.

In an embodiment, the circuitry 106 is activated, controlled, or deactivated by gesture. For example, the circuitry 106 can receive one or more sense signals from a gesture sensor of the system (e.g., an accelerometer, a motion sensor, a proximity sensor, a contact sensor, or other sensor) indicative of a gesture performed by the individual subject, such as a gesture with the body portion on which the system is positioned, a body portion proximate to the body portion on which the system is positioned, or other body portion. For example, the gesture can include a wave, a pinch, a rub, a squeeze, a click, a lift, a flick, a shake, or other gesture configured to activate, control, or deactivate the circuitry 106 via the one or more sense signals from gesture sensor. The system 100 can store a correspondence between a particular gesture and a functionality of the circuitry. For example, a first gesture (e.g., a wave gesture) can correspond to execution of a first program or protocol (e.g., a reporting protocol to cause the circuitry 106 to instruct the reporter 108 to generate the one or more communication signals), a second gesture (e.g., a pinch gesture) can correspond to execution of a second program or protocol (e.g., a sensing protocol to cause the circuitry 106 to activate or deactivate the sensor assembly 104), and where a third gesture (e.g., a shake gesture) can correspond to execution of a third program or protocol (e.g., a power protocol to cause the system 100 to power up or power down), and so on.

In an embodiment, as shown in FIG. 6, the system 100 includes a power supply 600 configured to provide power to one or more components of the system 100 including, but not limited to, the sensor assembly 104, the circuitry 106, and the reporter 108. For example, the power supply 600 can be a resident device component that is coupled to the deformable substrate 102. Examples of resident device components include, but are not limited to, batteries (e.g., a thin film battery, a microbattery), solar cells (e.g., silicon-based solar cells) configured to convert light energy into electrical energy for use by the components of the system 100, fuel cells, and energy harvesting devices (e.g., power devices configured to generate power from motion, such as motion of the body portion, motion of blood flow, and so forth). In embodiments, the power supply 600 includes one or more components positioned remotely from the deformable substrate 102 that transmit power signals via associated wireless power methods including, but not limited to, inductive coupling of power signals. In such embodiments, the system 100 includes one or more components positioned on the deformable substrate 102 configured to one or more of receive, process, and/or distribute the power signals that originate from components positioned remotely from the deformable substrate 102. For example, the system 100 can include a wireless power coil coupled to the deformable substrate 102 that is configured to receive a remote power signal, such as a remote power signal originating from a remote transmission coil. In an embodiment, the power supply 600 includes stretchable or flexible electronics. For example, the power supply 600 can include a silicon filamentary serpentine-shaped photovoltaic cell. For example, the power supply 600 can include filamentary serpentine-shaped inductive coils.

The reporter 108 of the system 100 is configured to generate one or more communication signals to report information associated with operation of the system 100. In an embodiment, the reporter 108 is operably coupled to the circuitry 106 and is configured to generate one or more communication signals responsive to instruction by the circuitry 106. The communication signals can be associated with the one or more identity sense signals generated by the sensor assembly 104 (e.g., via the one or more identity sensors 200), with a comparison of the one or more identity sense signals with the one or more physical

characteristics associated with the identity of the at least one individual (e.g., as provided by the circuitry 106 to determine whether the one or more identity signals correspond to the identity of the at least one individual), or a combination thereof. For example, the reporter 108 can report that the individual on which the system 5 100 is placed corresponds to a first individual (e.g., it is Bob), the reporter 108 can report that the information transmitted is a second individual's physical characteristics (e.g., this information corresponds to the skin topography feature of Jan), the reporter 108 can report that the system 100 is unable to determine an identity of the individual (e.g., the physical characteristics measured by the sensor 10 104 do not correspond to, or do not meet a threshold correspondence to, any of Bob, Jan, or Joe), or the like. In an embodiment, the communication signals are reportable to an external device or system (e.g., external device 800, described further herein). For example the external device or system can include, but is not limited to, a computing device, system or network (e.g., a personal 15 computing device, an electronic health record, etc.), or an electronic device (e.g., an electronic game, an electronic controller such as on a vehicle or instrument, or other electronic equipment). In an embodiment, the system 100 can transmit the one or more communication signals to a computing device having at least one of circuitry or programming that collects data from one or more wearable sensors 20 that are part of the system 100 or are otherwise associated with the individual on which the system 100 is positioned, so that the computing device can associate data within the communication signals with the individual. The system 100, via the reporter 108, can transmit identity information to an electronic controller equipped with authorization capabilities for employment in authorizing use of one 25 or more devices, programs, device functionalities, or the like, by the identified individual. For example, the system 100 can transmit information that the individual is identified as Bob, whereby the electronic controller can facilitate use of one or more devices, programs, device functionalities by Bob, according to his identity.

30 In an embodiment, shown in FIG. 7, the reporter 108 includes one or more of a transmitter 700, a transceiver 702, or a receiver 704. For example, the reporter 108 can include an antenna structure configured to at least one of transmit the one or more communication signals (e.g., via the transmitter 700, the

transceiver 702, etc.) or receive one or more communication signals from an external device (e.g., via the transceiver 702, the receiver 704, etc.). The one or more communication signals from the external device can include but are not limited to, control programming, authorization parameters, reference data, or a query (e.g., a query to transmit information from the system 100 to the external device). In an embodiment, the sensor assembly 104 includes one or more of a transceiver (e.g., transceiver 702) or a receiver (e.g., receiver 704) configured receive one or more communication signals from an external device. For example, the one or more communication signals from the external device can include but are not limited to, control programming, authorization parameters, reference data, or a query (e.g., a query to begin sensing physical characteristics of the individual subject on which the system 100 is positioned).

In an embodiment, the system 100 includes a unique identifier associated with at least one of the deformable substrate 102, the sensor assembly 104, the circuitry 106, or the reporter 108. The unique identifier can facilitate identifying a source of data, a source of communication signals, or the like, such as when multiple identification devices or systems 100 are utilized in combination to identify a plurality of individual subjects or when multiple identification devices or systems 100 are utilized by an individual subject, e.g., over a period of time. For example, when the reporter 108 generates the one or more communication signals for transmission (e.g., to an external device), the one or more communication signals can be associated with or can include the unique identifier to identify the source of the one or more communication signals, which in turn can be associated with a particular identity of an individual on which the system 100 is positioned. The external device can therefore associate the identity of the individual with the particular device in future communications, actions, queries, and the like. When multiple identification devices or systems 100 are utilized by the individual subject the use of such identification devices or systems 100 can be tracked via the unique identifier associated with each identification device or system. For example, the unique identifier can designate a source for communications, measurements, identifications, etc. as being directed to a specific identification device or system 100 (e.g., a lot number), where the communications can be tracked sequentially (when multiple identification devices or systems 100 are

utilized by the individual subject over a period of time), in parallel (when multiple identification devices or systems 100 are utilized by the individual subject at a given time), or a combination thereof (when multiple identification devices or systems 100 are utilized by the individual subject over a period of time and at a given time).

In an embodiment, shown in FIG. 8, the system 100 further includes an external device or system (referred to herein as external device 800) configured to receive communications from the reporter 108 for analysis by the external device 800. The external device 800 can include a receiver 802 (e.g., receiving antenna, transceiver, etc.) configured to receive the one or more communication signals from the reporter 108. The external device 800 can also include circuitry 804 configured to compare the one or more communication signals with one or more authorization parameters associated with one or more users authorized to operate the external device 800. For example, the external device 800 can include, or can access, a computer memory device 806 that maintains data associated with authorization parameters pertinent to operation of the external device 800. The authorization parameters can include but are not limited to, a list of identified individuals, identities, devices, or systems authorized to operate at least a portion of features of the external device 800, a list of reference physical characteristics for one or more users authorized to operate the external device 800, a list of functionalities of the external device 800 that identified individuals are authorized to utilize, or the like. For example, the external device 800 can receive the communication signals from the reporter 108 indicating an identity of the individual subject on whom the deformable substrate 102 is positioned, whereby the external device 800 can compare (e.g., via the circuitry 804) the identity of the individual with the authorization parameters stored in the memory 806 to determine whether the identified individual is authorized to operate the external device 800, to determine which functionalities of the external device 800 the identified individual is authorized to operate, or the like. As another example, where the authorization parameters includes a list of identified devices or systems, such devices or systems can automatically operate the portion of features of the external device 800, such as without interaction with the individual subject or other individual. The external device 800 can include but is not limited

to, a communication device or electronic equipment, such as one or more of a mobile communication device or a computer system including, but not limited to, mobile computing devices (e.g., hand-held portable computers, Personal Digital Assistants (PDAs), laptop computers, netbook computers, tablet computers, or so forth), mobile telephone devices (e.g., cellular telephones and smartphones), devices that include functionalities associated with smartphones and tablet computers (e.g., phablets), portable game devices, portable media players, multimedia devices, satellite navigation devices (e.g., Global Positioning System (GPS) navigation devices), e-book reader devices (eReaders), Smart Television (TV) devices, surface computing devices (e.g., table top computers), Personal Computer (PC) devices, devices that employ touch-based human interfaces, currency-handling devices (e.g., automated teller machines (ATMs), cash registers, coin/bill counters and sorters, credit/debit card readers, etc.), a motorized vehicle or control systems thereof (e.g., car, truck, motorcycle, boat, snowmobile, airplane, helicopter, etc.), exercise facilities or equipment, a home security system, an electronic medication dispenser (e.g., pill dispenser), medical treatment facilities or equipment (e.g., patient suites, surgical suites, surgical equipment, etc.), rental equipment with a user interface (e.g., video rentals, audio rentals, etc.), transportation security terminals (e.g., airport security terminal, train security terminal, ferry security terminal, etc.), personnel-tracking equipment, heavy or specialized machinery, specialized tools, safety equipment, security equipment (e.g., a lock or access point), medical equipment (e.g., drug delivery devices or surgical tools), or personal equipment or clothing having customizable electronic features. The reporter 108 can communicate (e.g., send and receive communication signals) with the external device 800 via one or more connected or wireless communication mechanisms including, but not limited to acoustic communication signals, sound communication signals (e.g., audible, inaudible, or combinations thereof), optical communication signals, radio communication signals, infrared communication signals, ultrasonic communication signals, electric signals (e.g., via a conduction pathway between a component of the system 100 and the external device 800), and the like. In an embodiment, one or more of the sensor assembly 104 or the circuitry 106 can receive communication signals from the external device 800. For example, the external device 800 (e.g., a cellular or

network-based device) can transmit one or more communication signals to one or more of the sensor assembly 104 or the circuitry 106, where such communication signals can initiate or terminate particular functionalities of the sensor assembly 104 or circuitry 106 (e.g., turn on/off), provide programming information, provide
5 updated functionalities, provide or update comparison threshold values or reference data, or the like. In an embodiment, the circuitry 106 directs the reporter 108 to generate the one or more communication responsive to a query from the external device 800. In an embodiment, the reporter 108 generates the one or more communication signals responsive to instruction by the circuitry 106
10 without any dependence or communication from the external device 800. For example, the reporter 108 can generate the one or more communication signals regardless of whether the external device 800 is capable of receiving the communication signals. In such instances, the communication signals generated by the reporter 108 can be stored in memory of the system 100, where the stored
15 communication signals can be utilized later (e.g., to program one or more new systems 100, external devices 800, etc.).

In an embodiment, one or more of the sensor assembly 104, the circuitry 106, or the reporter 108 facilitates interaction between the system 100 and one or more other devices or systems resident on the body of the individual on which the
20 system 100 is positioned. For example, the external device 800 can include one or more devices or systems (e.g., one or more sensors, computing devices, or the like) that also reside on the individual on which the system 100 is positioned. In an embodiment, the system 100 includes the one or more other devices or systems resident on the body of the individual, such as additional sensing devices
25 communicatively coupled with one or more of the sensor assembly 104, the circuitry 106, or the reporter 108. For example, when a sensing device resident on the body of the individual is active (e.g., a heart rate monitor), the output of the sensing device can be associated with the identity of the individual by the association between the sensing device resident on the body and the activities of
30 one or more of the sensor assembly 104, the circuitry 106, or the reporter 108 (e.g., the heart rate measured by the heart rate monitor can be associated with the identity of individual on which the devices or systems are positioned).

The system 100 can also include other sensors to provide functionalities independent of identification, supportive of identification, or the like. For example, in an embodiment, shown in FIG. 9, the system 100 includes one or more of a physiological sensor 900, a proximity sensor 902, a contact sensor 904, a pressure sensor 906, or a temperature sensor 908. In an embodiment, one or more of the physiological sensor 900, the proximity sensor 902, the contact sensor 904, the pressure sensor 906, or the temperature sensor 908 can provide sense signals indicative of whether the deformable substrate 102 is attached to, maintained against, or otherwise in contact with a skin surface of the individual. For example, the circuitry 106 can receive the sense signals from one or more of the physiological sensor 900, the proximity sensor 902, the contact sensor 904, the pressure sensor 906, or the temperature sensor 908 and can activate the sensor assembly 104 to begin identification of the individual subject responsive to confirmation of the presence of the deformable substrate 102 on the skin surface.

In an embodiment, shown in FIG. 10, the circuitry 106 includes an identity comparison module 1000 and an authorization comparison module 1002. The identity comparison module 1000 is configured to compare the one or more identity sense signals generated by the sensor assembly 104 to reference data indicative of one or more physical characteristics associated with an identity of at least one individual to determine whether the one or more identity sense signals correspond to the identity of the at least one individual. For example, the identity comparison module 1000 can include structure and functionality similar to, or the same as, the comparison module 400 described herein. The reference data indicative of one or more physical characteristics associated with an identity of at least one individual can be stored in a computer memory device 1004 accessible by the circuitry 106, the identity comparison module 1000, or the authorization comparison module 1002. For example, the computer memory device 1004 can store data associated with a list of identities (e.g., names of individuals) having associated physical characteristics attributable to the particular identity (e.g., a skin topography feature associated with and unique to a first identity, a skin topography feature associated with and unique to a second identity, and the so forth). The authorization comparison module 1002 is configured to compare at least one of the one or more identity sense signals or the identity of the at least

one individual with one or more authorization parameters. The authorization parameters can include but are not limited to, a list of identified individuals or identities authorized to operate at least a portion of features of the system 100, a list of identified authorized individuals or identities under which at least a portion of
5 features of the system 100 (e.g., reporter 108) will function, a list of identified individuals or identities authorized to operate at least a portion of features of an external device (e.g., external device 800), a list of reference physical characteristics for one or more users authorized to operate an external device (e.g., external device 800), a list of functionalities of an external device (e.g.,
10 external device 800) that identified individuals are authorized to utilize, or the like.

In an embodiment, the reporter 108 is configured to generate the one or more communication signals responsive to instruction by the circuitry 106, where the one or more communication signals are associated with a comparison of at least one of the one or more identity sense signals with the one or more
15 authorization parameters or the identity of the at least one individual with the one or more authorization parameters. For example, instances where the one or more communication signals are based on a comparison of one or more identity sense signals with the one or more authorization parameters, the authorization comparison module 1002 can directly compare the one or more identity sense
20 signals with authorization parameters stored in the memory 1004. The authorization parameters can include a list of physical characteristics of authorized individuals, such that when the identity sense signals match the physical characteristics of authorized individuals stored in memory, the individual subject can be authorized. For example, authorization can include, but is not
25 limited to, the individual being authorized to utilize the system 100 or to use an external device (e.g., where that individual subject substantially matches one identity of the list of individuals authorized to operate the external device), or the system 100 can function fully (e.g., can transmit information) or a portion of the functionalities of the system 100 to which the authorized individual is permitted to
30 utilized are enabled. When the one or more communication signals are based on a comparison of the identity of the at least one individual with the one or more authorization parameters, the identity comparison module 1000 can first identify the individual based on the one or more identity sense signals, whereby the

authorization comparison module 1002 can determine whether the identified authorized individual is (e.g., by comparing the identity to reference data having a list of authorized individuals or identities). In an embodiment, when the one or more authorization parameters corresponds to a single authorized user, the identity comparison module 1000 and the authorization comparison module 1002 can be incorporated as a single module for automatic authentication after identification.

In an embodiment, shown in FIG. 11, the circuitry 106 includes a comparison module 1100 configured to compare the one or more identity sense signals generated by the sensor assembly 104 to reference data indicative of one or more physical characteristics associated with a physical state of the individual to determine whether the individual subject is authorized to operate an external device. For example, the memory 1004 can store reference data associated with physical states including but not limited to, a vital status (e.g., physiological reference data indicative of a living status or a deceased status, physiological data associated with a distress or stress status, or the like) or a functional status (e.g., a physical status, a mental status, or the like). In an embodiment, the comparison module compares sense signals from other sensors of the system (e.g., one or more of the physiological sensor 900, the proximity sensor 902, the contact sensor 904, the pressure sensor 906, or the temperature sensor 908) to determine the vital status or the functional status of the individual. The reference data indicative of one or more physical characteristics associated with a functional status can include but are not limited to, chemical or biological indicators of inebriation or intoxication (e.g., by drugs or alcohol), the presence or absence of a substance (e.g., a toxin, a poison, a prescription medication), a blood oxygenation level, a movement, pattern of movement, or absence of movement (e.g., as indicators of a state of consciousness or of compromised fine motor skills), or so forth. The vital status or the functional status can serve as an indicator as to whether an identified individual is in a state suitable for operation of the external device. For example, while the individual subject may be identified and authorized to use a device, the current status of the individual may preclude total or partial operation of the external device. For example, the sensors of the system 100 may detect that the individual does not have sufficient levels of medication in their

bloodstream (e.g., a person with tremors or seizures) to safely operate a motorized vehicle for an extended period of time. In an embodiment, the circuitry 106 is configured to prevent authorization of the individual subject to operate at least a portion of the external device responsive to a correspondence between the one or more identity sense signals and the reference data indicative of the one or more physical characteristics associated with the functional status of the individual being above a functional threshold correspondence. For example, the functional threshold correspondence can be related to a safety threshold of a physical characteristic for operation of the external device (e.g., a blood alcohol content, a medication level, etc.). In an embodiment, the circuitry 106 prevents authorization of the individual subject by not instructing the reporter 108 to generate or transmit the one or more communication signals. In an embodiment, the circuitry 106 can permit partial authorization of operation of the external device, such that only a subset of functionalities of the external device is available to the individual for operation. For example, if an individual is identified and authorized to use a smart phone device, and that individual is determined to be intoxicated or to otherwise have a diminished functional status, the circuitry 106 can permit phone calls or web browsing functionalities, but prevent financial transaction functionalities.

In an embodiment, shown in FIG. 12, the reporter 108 includes a display device 1200 configured to provide a visual indication associated with an output of the reporter 108. For example, the display device 1200 can include one or more light-emitting elements 1202 (e.g., light-emitting diodes, polymer light-emitting diodes (PLEDs), lasers, or other light source(s)) configured to provide a predetermined pattern of light corresponding to a comparison between at least one of the one or more identity sense signals with the one or more authorization parameters or the identity of the at least one individual with the one or more authorization parameters. The predetermined pattern of light can include patterns associated with light intensity or brightness, color, shapes, or other characteristics discernable between distinct patterns. In an embodiment, the predetermined pattern includes a first pattern associated with a correspondence between at least one of the one or more identity sense signals with the one or more authorization parameters or the identity of the at least one individual with the one or more authorization parameters being below a threshold correspondence (e.g., the

physical characteristics measured by the sensor assembly 104 do not correspond to an authorized individual), and the predetermined pattern includes a second pattern associated with a correspondence between at least one of the one or more identity sense signals with the one or more authorization parameters or the identity of the at least one individual with the one or more authorization parameters being at least at the threshold correspondence (e.g., the physical characteristics measured by the sensor assembly 104 correspond to an authorized individual). For example, the reporter 108 can display via the display device a first pattern (e.g., a first intensity, a first color, a first shape, etc.) if the individual subject is not authorized to operate the external device, and can display a distinct second pattern (a second intensity, a second color, a second shape, etc.) if the individual subject is authorized to operate the external device. The system 100 can also include one or more photodetectors, such as one or more organic photodetectors (OPDs), to detect light from the display device 1200 and/or the sensor assembly 104, such as light reflected by or refracted from a body portion. For example, the system 100 can include an organic photodetector comprising an active layer of poly(3-hexylthiophene) (P3HT):(6,6)-phenyl-C61-butyric acid methyl ester (PCBM).

In an embodiment, the display device 1200 includes can include one or more sound-emitting elements 1204 (e.g., speaker, tone-source, or other sound source(s)) configured to provide a predetermined pattern of sound corresponding to a comparison between at least one of the one or more identity sense signals with the one or more authorization parameters or the identity of the at least one individual with the one or more authorization parameters. The predetermined pattern of sound can include patterns associated with sound intensity, audible and inaudible phases, or other characteristics discernable between distinct patterns. In an embodiment, the predetermined pattern includes a first pattern associated with a correspondence between at least one of the one or more identity sense signals with the one or more authorization parameters or the identity of the at least one individual with the one or more authorization parameters being below a threshold correspondence (e.g., the physical characteristics measured by the sensor assembly 104 do not correspond to an authorized individual), and the predetermined pattern includes a second pattern associated with a

correspondence between at least one of the one or more identity sense signals with the one or more authorization parameters or the identity of the at least one individual with the one or more authorization parameters being at least at the threshold correspondence (e.g., the physical characteristics measured by the sensor assembly 104 correspond to an authorized individual). For example, the reporter 108 can display via the display device a first pattern (e.g., a first intensity, a first audible/inaudible pattern, etc.) if the individual subject is not authorized to operate the external device, and can display a distinct second pattern (a second intensity, a second audible/inaudible pattern, etc.) if the individual subject is authorized to operate the external device.

In an embodiment, the display device 1200 includes a projection display 1206 configured to provide a visual indication associated with an output of the reporter 108. For example, the projection display 1206 can be configured to provide a projected image (e.g., projected onto a skin surface, onto a clothing item or garment, onto a wall or support surface, onto a screen, etc.) corresponding to a comparison between at least one of the one or more identity sense signals with the one or more authorization parameters or the identity of the at least one individual with the one or more authorization parameters.

In an embodiment, the circuitry 106 is configured to determine whether the deformable substrate 102 has been removed from the skin surface of the individual subject. For example, the system 100 can include, as a part of the sensor assembly 104, distinct from the sensor assembly 104, or a combination thereof, one or more of a strain gauge or a proximity sensor configured to sense whether the deformable substrate 102 has been removed from the skin surface of the individual subject. For example, the system 100 can include a computer memory device storing reference data associated with strain or distance measurements corresponding to removal of the deformable substrate 102 from a skin surface. The circuitry 106 can compare the output from the strain gauge or proximity sensor to such reference data to determine whether the deformable substrate 102 has been removed. In an embodiment, the circuitry 106 is configured to determine whether the deformable substrate 102 has been applied to a skin surface that differs from the skin surface of the individual subject. For example, the system 100 can store in a computer memory device the one or more

identity sense signals obtained by the sensor assembly 104 at a first time, whereby the circuitry 106 can compare one or more identity sense signals obtained by the sensor assembly 104 at a second time to the stored identity sense signals obtained by the sensor assembly 104 at the first time to determine
5 whether the signals substantially differ. If the signals are directed to a skin property, a substantial difference between signals obtained at differing times can indicate that the skin surface differs between the first time and the second, which can indicate that the system 100 was transferred between different individuals between the first time and the second time.

10 The reporter 108 can generate the one or more communication signals responsive to a variety of scenarios involving one or more of identification or authorization. For example, in an embodiment, the one or more communication signals generated by the reporter 108 correspond to a lack of authorization of the individual subject to operate an external device responsive to a correspondence
15 between the one or more identity sense signals and the reference data indicative of one or more physical characteristics associated with the identity of the at least one individual being below a threshold correspondence. For example, when the circuitry 106 (e.g., via the identity comparison module 1000) is unable to identify the individual subject on which the system 100 is positioned, the reporter 108 can
20 report via the communication signals that the individual subject is not authorized to operate the external device on the basis that such individual subject is not recognizable. In an embodiment, when the circuitry 106 (e.g., via the identity comparison module 1000) is unable to identify the individual subject on which the system 100 is positioned, the circuitry 106 prevents generation of the
25 communication signals by the reporter 108 (e.g., no instruction from the circuitry 106 to the reporter 108 regarding generation of the one or more communication signals). In an embodiment, the one or more communication signals generated by the reporter 108 correspond to authorization of the individual subject to operate an external device responsive to both of (i) a correspondence between the one or
30 more identity sense signals and the reference data indicative of one or more physical characteristics associated with the identity of the at least one individual being at least at a threshold correspondence and (ii) a correspondence between at least one of the one or more identity sense signals or the identity of the at least

one individual with one or more authorization parameters being at least at a threshold correspondence. For example, when the circuitry 106 is able to identify the individual subject on which the system 100 is positioned (e.g., via the identity comparison module 1000) and the circuitry 106 is able to authorize the individual
5 subject on which the system 100 is positioned for operation of the external device (e.g., via the authorization comparison module 1002), the reporter 108 can report via the communication signals that the individual subject is authorized to operate the external device.

In an embodiment, the reporter 108 is configured to provide a static output
10 of communication signals. In an embodiment, the reporter 108 is configured to continuously generate the one or more communication signals. In an embodiment, the reporter 108 is configured to provide a dynamic output of communication signals. In an embodiment, the reporter 108 is configured to generate the one or more communication signals responsive to a query from an
15 external device (e.g., external device 800). In an embodiment, the reporter 108 is configured to generate the one or more communication signals responsive to a proximity between the reporter 108 and an external device (e.g., external device 800). For example, the system can include a proximity sensor (e.g., proximity sensor 902) configured to generate sense signals indicative of proximity between
20 the reporter 108 and an external device (e.g., external device 800). The circuitry 106 can compare the sense signals from the proximity sensor to reference data (e.g., a threshold proximity) to determine whether the reporter 108 and the external device 800 are close enough to begin transmission of communication signals from the reporter 108 to the external device 800, and instruct the reporter
25 108 to generate the one or more communication signals when it is determined that the reporter 108 and the external device 800 are within a threshold proximity.

In an embodiment, shown in FIG. 13, the system 100 includes the deformable substrate 102, the sensor assembly 104, the circuitry 106, and an adhesive 1300. The adhesive 1300 is coupled to a surface of the deformable
30 substrate 102 and configured to adhere the deformable substrate 102 to the skin surface of the individual subject. The adhesive 1300 is configured to transition from a first state (e.g., an adhesive state) to a second state (e.g., a non-adhesive state) responsive to one or more energy signals (e.g., electric signals, thermal

signals, magnetic signals, light signals, etc.) from the circuitry 106. In an embodiment, the circuitry 106 is configured to generate the one or more energy signals responsive to a correspondence between the one or more identity sense signals and the one or more physical characteristics associated with the identity of the at least one individual being below a threshold correspondence. For example, if the circuitry 106 cannot determine the identity of the individual subject on whom the system 100 is positioned (e.g., via one or more of the comparison module 400 or the identity comparison module 1000), the circuitry 106 generates the one or more energy signals to transition the adhesive 1300 from an adhesive state to a non-adhesive state. When in the non-adhesive state, the adhesive 1300 lacks sufficient ability (e.g., adhesive properties, tackiness, adhesion properties, or the like) to keep the deformable substrate 102 secured in place relative to the skin surface of the individual subject (e.g., a low adhesive state). Thus, when the adhesive 1300 is in the non-adhesive state, the system 100 can lose functionality or operability with respect to an individual subject that cannot be readily identified.

In an embodiment, shown in FIG. 14, the adhesive 1300 can include one or more of an electro-responsive adhesive, such as an electroactive polymer 1400, a thermo-responsive adhesive 1402, a magnetic-responsive adhesive 1404, a light-responsive adhesive 1406, or a reversible microstructure 1408. The electroactive polymer 1400 can be actuatable by the one or more energy signals from the circuitry 106 to provide reversible or switchable adhesion characteristics, such as to transition between the adhesive state and the non-adhesive state. For example, the electroactive polymer 1400 can be configured to change a dimension or shape responsive to the one or more energy signals, which can increase or decrease the adhesive effect between the electroactive polymer 1400 and the skin surface to which the system 100 is applied (such as through a change in the amount of surface area in contact with the skin surface, or the like). The electroactive polymer 1400 can include, for example, an electroactive hydrogel, dielectric polymer, electrorestrictive polymer, electroviscoelastic polymer, ferroelectric polymer (e.g., PVDF), liquid crystal elastomer, ionic polymer (e.g., an ionomer such as Nafion), conductive polymer (e.g., polyaniline or polypyrrole films), ionomeric polymer-metallic composite (IPMC), conjugated polymer (e.g., peptide-conjugated PEDOT), single-network or double-network

stimuli-responsive gel (e.g., methacrylates such as PMAA and POEGMA), carbon structures (including nanostructures), and the like. In an embodiment, the electroactive polymer 1400 is configured to reversibly transition between the adhesive state and the non-adhesive state responsive to the one or more energy signals from the circuitry 106. In an embodiment, the electroactive polymer 1400 is configured to reversibly transition between the nonadhesive state and the adhesive state responsive to the one or more energy signals from the circuitry 106.

The thermo-responsive adhesive 1402 can be actuable by a change in temperature of the adhesive responsive to the one or more energy signals from the circuitry 106 to transition from the adhesive state to the non-adhesive state. For example, the thermo-responsive adhesive 1402 can be configured to at least partially ablate due to an increase in temperature responsive to interaction with the one or more energy signals from the circuitry 106, which can lead to loss or lessening of adhesion. The thermo-responsive adhesive 1402 can include, for example a thermo-responsive polymer, such as a polyacrylamide (e.g., Poly(N-isopropylacrylamide or poly(N,N-diethylacrylamide)), a shape memory polymer (e.g., epoxy-based), or a L-3,4-dihydroxyphenylalanine (DOPA)-modified polymer. In an embodiment, the thermo-responsive adhesive 1402 is configured to reversibly transition between the adhesive state and the non-adhesive state responsive to the one or more energy signals from the circuitry 106. In an embodiment, the thermo-responsive adhesive 1402 is configured to reversibly transition between the nonadhesive state and the adhesive state responsive to the one or more energy signals from the circuitry 106. For example, a thermoresponsive adhesive that becomes adhesive to tissue above a predetermined temperature (e.g., 32 degrees C) and will lose its adhesive properties below that temperature responsive to the thermal energy signal. For example, a thermal-responsive adhesive includes a DOPA-modified PEG polymer and an oxidizing reagent stored in liposomes, which, when thermally triggered by the energy source, release the oxidizing agent thereby transforming the polymer to an adhesive hydrogel.

The magnetic-responsive adhesive 1404 can be actuable by application of a magnetic field, or change in a magnetic field, applied to the adhesive

responsive to the one or more energy signals from the circuitry 106, such as to transition from the adhesive state to the non-adhesive state. The magnetic-responsive adhesive 1404 can include, for example an array of micropillars formed with polydimethylsiloxane (PDMS) that has incorporated metallic micro-or nanoparticles such as neodymium (NdFeB) microparticles. In an embodiment, the magnetic-responsive adhesive 1404 is configured to reversibly transition between the adhesive state and the non-adhesive state responsive to the one or more energy signals from the circuitry 106. In an embodiment, the magnetic-responsive adhesive 1404 is configured to reversibly transition between the nonadhesive state and the adhesive state responsive to the one or more energy signals from the circuitry 106.

The light-responsive adhesive 1406 can be actuatable by application of a light source, or change in exposure to light, applied to the adhesive responsive to the one or more energy signals from the circuitry 106, such as to transition from the adhesive state to the non-adhesive state. The light-responsive adhesive 1406 can include, for example an azobenzene-modified glycoconjugate, azo-containing liquid crystalline network (LCN) micropillars, or combinations thereof. In an embodiment, the light-responsive adhesive 1406 is configured to reversibly transition between the adhesive state and the non-adhesive state responsive to the one or more energy signals from the circuitry 106. In an embodiment, the light-responsive adhesive 1406 is configured to reversibly transition between the nonadhesive state and the adhesive state responsive to the one or more energy signals from the circuitry 106. In embodiments, the light-responsive adhesive 1406 is sensitive to particular wavelengths of light (e.g., ultraviolet light, blue light, etc.). For example, application of the particular wavelengths of light can provide mitigation of the adhesive effect of the light-responsive adhesive 1406.

The reversible microstructure 1408 can be configured to transition between the adhesive state and the non-adhesive state responsive to the one or more energy signals from the circuitry 106. For example, the reversible microstructure 1408 can include microtip surfaces, such as elastomeric microtip surfaces, having geometric (e.g., pyramidal) structures protruding from posts arranged in arrays (e.g., square arrays). Such configurations can permit collapse of regions between the posts of the arrays between the protruding geometric structures, such as when

subjected to an applied force. The reversible microstructure 1408 can provide differing levels of adhesion based on the underlying attractive forces between, for example, the reversible microstructure 1408 and a skin surface to which the system 100 is applied. For instance, the reversible microstructure 1408 can
5 provide a generally high level of adhesion when the regions between the microtips are collapsed to maximize contact area between the reversible microstructure 1408 and the skin surface, which can facilitate van der Waals interactions. When the posts are permitted to retract to a resting state (e.g., neutral elastomeric positions), the adhesive effect is substantially reduced as compared to the
10 collapsed state. In an embodiment, the reversible microstructure 1408 is configured to reversibly transition between the adhesive state and the non-adhesive state responsive to the one or more energy signals from the circuitry 106.

In embodiments, the reversible microstructure 1408 can comprise
15 micropillar or microfibrillar structures or an array thereof, which can include biomimetic structural designs that confer adhesive properties (e.g., van der Waals forces, directional adhesion, and frictional adhesion) of natural setae (e.g., gecko setae), designs including anisotropic, asymmetrical materials or structure design (e.g., for anisotropic directional and frictional adhesion), and end shape design.
20 For example, end shapes can include one or more of a plate shape (e.g., T or L shapes), semi-sphere shape, concave shape, mushroom shape, fibrillar shapes, or lamellae (e.g., in an hierarchical structure). Micropillar or microfibrillar structures can be formed from energy-responsive materials, energy non-responsive materials, or mixtures thereof including, but not limited to, polyimide, PVS, PDMS,
25 poly(methyl methacrylate) (PMMA), polyurethane, polystyrene (PS), silicon rubber, polypropylene, polyethylene, poly(methylvinylsiloxane) (PMVS), IPMC, and other polymers listed in here, as well as carbon structures (including nanostructures). Different portions (e.g., the end shape) of a micropillar or microfibrillar structure can be formed from a material that is different than that
30 forming another portion (e.g., the pillar or fiber) of the structure. At least a portion of a micropillar or microfibrillar structure can be coated, for example with an energy-responsive polymer or with a substance that confers biocompatibility. Micropillar or microfibrillar structures can be configured to transition between the

adhesive state and the non-adhesive state responsive to the one or more energy signals from the circuitry 106. In an embodiment, the reversible microstructure 1408 is configured to reversibly transition between the adhesive state and the non-adhesive state responsive to the one or more energy signals from the circuitry 5 106. For example, adhesive properties of a reversible microstructure that includes micropillar or microfibrillar structures can be altered by altering the orientation of the micropillar or microfibrillar structures (thereby altering the frictional or directional adhesive properties), responsive to the one or more energy signals from the circuitry 106. In an embodiment, the magnetic-responsive adhesive 1404 10 includes micropillar structures with a T-shaped ending and formed from a magnetic-responsive material (e.g., PDMA with NdFeB microparticles) controllably tilt in the presence of a magnetic field according to the strength and direction of the field, so that adhesion of the micropillar structures can be controllably disrupted responsive to the one or more electromagnetic signals from the circuitry 15 106.

In an embodiment, the adhesive 1300 includes an actuator responsive to the one or more energy signals from the circuitry 106. For example, an array of micropillars formed from PMVS is attached to an actuator of IPMC, which, responsive to the one or more energy signals from the circuitry 106 (e.g., at 1.0, 20 1.5, or 2.0 V depending on desired adhesion), bends driving the micropillars to actively adhere to or release the surface.

In an embodiment, shown in FIG. 15, the system 100 includes a reservoir 1500 configured to release an adherence mitigator responsive to the one or more energy signals from the circuitry 106. The adherence mitigator is configured to 25 interact with the adhesive 1300 to transition the adhesive 1300 from the adhesive state to the non-adhesive state. For example, the adherence mitigator can include a substance having a pH (e.g., an acid) that alters the ionic properties of the adhesive (e.g., a single or double network poly(methacrylic acid) hydrogel that bonds at pH 6 but loses adhesion when exposed to acidic pH). For example, 30 the adherence mitigator can include a solvent that degrades a polymer adhesive. The reservoir 1500 can be formed from a portion of the material of the deformable substrate 102, can be formed from a structure positioned on a surface of the deformable substrate 102, or a combination thereof. In an embodiment, the

reservoir 1500 includes a plurality of reservoirs, configured to release the reservoir contents temporally, sequentially, in parallel, or in combinations thereof. In an embodiment, the reservoir 1500 includes an energy-responsive hydrogel configured to release the reservoir contents upon stimulation (e.g., in response to the one or more energy signals, in response to an electric signal, in response to a thermal signal, in response to an electromagnetic signal, etc.) In scenarios where the individual subject cannot be identified, or where the individual subject is identified but not authorized to operate an external device, the circuitry 106 can generate one or more energy signals to activate the reservoir 1500 to cause release of the adherence mitigator, thereby permitting interaction between the adherence mitigator and the adhesive 1300. In an embodiment, the adherence mitigator includes one or more of a fluid material or a powdered material. In an embodiment, the adhesive 1300 is configured to transition from the non-adhesive state to the adhesive state upon removal of the adherence mitigator. For example, the adherent material can be washed or otherwise removed from contact with the adhesive 1300 to permit the adhesive 1300 to attain the adhesive state. In an embodiment, the adherence mitigator is configured to degrade at least a portion of at least one of the adhesive 1300, the deformable substrate 102, the sensor assembly 104, or the circuitry 106. Such degradation can influence the functionality of one or more of the adhesive 1300, the deformable substrate 102, the sensor assembly 104, or the circuitry 106, such as by causing at least a portion of the adhesive 1300, the deformable substrate 102, the sensor assembly 104, or the circuitry 106 to become inoperative. In an embodiment, the one or more energy signals generated by the circuitry 106 are configured to degrade at least a portion of at least one of the adhesive 1300, the deformable substrate 102, the sensor assembly 104, or the circuitry 106. Such degradation can influence the functionality of one or more of the adhesive 1300, the deformable substrate 102, the sensor assembly 104, or the circuitry 106, such as by causing at least a portion of the adhesive 1300, the deformable substrate 102, the sensor assembly 104, or the circuitry 106 to become inoperative. For example, in scenarios where the individual subject cannot be identified, or where the individual subject is identified but not authorized to operate an external device, the circuitry 106 can generate one or more energy signals to cause the inoperability of one or more

functions of one or more of the adhesive 1300, the deformable substrate 102, the sensor assembly 104, or the circuitry 106, due to direct interaction with the energy signals or due to interaction with the adherence mitigator released from the reservoir 1500. In an embodiment (not shown) the system 100 includes a
5 reservoir configured to release an adherence promoter responsive to the one or more energy signals from the circuitry 106. For example, the adherence promoter can include a pH enhancer, a wetting agent, a drying agent, or the like.

FIG. 16 illustrates a method 1600 for identifying an individual using conformable electronics positioned on the individual. Method 1600 shows
10 generating one or more identity sense signals in block 1602, where the sense signals correspond to an individual subject and are generated by an identification device having a deformable substrate and at least one sensor coupled to the deformable substrate. For example, the sensor assembly 104 (e.g., one or more identity sensors 200) can generate one or more identity sense signals associated
15 with an individual subject on which the system 100 is positioned. Method 1600 also includes comparing the one or more identity sense signals to reference data indicative of one or more physical characteristics associated with an identity of at least one individual in block 1604. For example, the circuitry 106 can compare (e.g., via comparison module 400, via comparison module 1000, etc.) the identity
20 sense signals to reference data stored in memory (e.g., memory 402), where the reference data includes physical characteristics linked or associated with an identity of a known individual. Where the identity sense signals meet or exceed a threshold correspondence when compared to the reference data, the identity linked or associated with the physical characteristics stored in memory can be
25 correlated to the individual subject on which the system 100 is positioned (i.e., the individual subject can be presumed to have the known identity based on a successful correspondence). Where the identity sense signals do not meet a threshold correspondence when compared to the reference data, the identity linked or associated with the physical characteristics stored in memory cannot be
30 correlated to the individual subject on which the system 100 is positioned (i.e., the individual subject is not presumed to have the known identity based on the unsuccessful correspondence). Method 1600 also includes reporting one or more communication signals related to the identity sense signals or the comparison of

the identity sense signals to the reference data in block 1606. For example, the reporter 108 can generate the one or more communication signals responsive to instruction by the circuitry 106, where such communication signals can relate to the identity sense signals or to the comparison by the circuitry 106 of the identity sense signals with the reference data. For instance, the communication signals can indicate a successful correspondence between the identity signals and the reference data (e.g., provide the established identity of the individual subject on which the system 100 is positioned), can indicate an unsuccessful correspondence between the identity sense signals and the reference data (e.g., provide that the identity of the individual subject on which the system 100 is positioned cannot be established with a certain threshold correspondence), or the like.

FIG. 17 illustrates a method 1700 for identifying and authorizing an individual using conformable electronics positioned on the individual. Method 1700 shows generating one or more identity sense signals in block 1702, where the sense signals correspond to an individual subject and are generated by an identification device having a deformable substrate and at least one sensor coupled to the deformable substrate. For example, the sensor assembly 104 (e.g., one or more identity sensors 200) can generate one or more identity sense signals associated with an individual subject on which the system 100 is positioned. Method 1700 also includes comparing the one or more identity sense signals to reference data indicative of one or more physical characteristics associated with an identity of at least one individual in block 1704. For example, the circuitry 106 can compare (e.g., via comparison module 400, via identity comparison module 1000) the identity sense signals to reference data stored in memory (e.g., memory 402), where the reference data includes physical characteristics linked or associated with an identity of a known individual. Where the identity sense signals meet or exceed a threshold correspondence when compared to the reference data, the identity linked or associated with the physical characteristics stored in memory can be correlated to the individual subject on which the system 100 is positioned (i.e., the individual subject can be presumed to have the known identity based on a successful correspondence). Where the identity sense signals do not meet a threshold correspondence when compared to

the reference data, the identity linked or associated with the physical characteristics stored in memory cannot be correlated to the individual subject on which the system 100 is positioned (i.e., the individual subject is not presumed to have the known identity based on the unsuccessful correspondence). Method 5 1700 also includes comparing the one or more identity sense signals or a determined identity with one or more authorization parameters in block 1706. For example, the circuitry 106 can compare (e.g., via authorization comparison module 1002) the one or more identity sense signals with one or more authorization parameters to determine whether the identity sense signals 10 correspond to an individual that is authorized to operation an associated external device (such as when the reference data includes a list of physical characteristics associated with individuals authorized to operate at least a portion of the functionalities of the external device 800). The circuitry 106 can compare (e.g., via authorization comparison module 1002) an identity of the individual subject 15 (e.g., when the identity sense signals sufficiently correspond to the physical characteristics provided in the reference data in order to identify the individual subject) to a list of individuals authorized to operate the external device to determine whether the identified individual subject can operate at least a portion of the functionalities of the external device. Method 1700 also includes reporting 20 to an associated external device one or more communication signals related to the comparison with authorization parameters in block 1708. For example, the reporter 108 can generate the one or more communication signals responsive to instruction by the circuitry 106 to report to the external device 800, where such communication signals can relate to whether the individual subject is authorized to 25 operate the external device, such as by being unable to identify the individual (e.g., no authorization), by identifying the individual but the identified individual is not on the authorized list (e.g., no authorization), by successfully corresponding the identity sense signals with physical characteristics of authorized individuals (e.g., authorization), by identifying the individual and having the identified 30 individual being on the authorized list (e.g., authorization), or the like.

FIG. 18 illustrates a method 1800 for adjusting an adhesive state of an adhesive responsive to identification of an individual using conformable electronics. Method 1800 shows generating one or more identity sense signals in

block 1802, where the sense signals correspond to an individual subject and are generated by an identification device having a deformable substrate and at least one identity sensor coupled to the deformable substrate. For example, the sensor assembly 104 (e.g., one or more identity sensors 200) can generate one or more
5 identity sense signals associated with an individual subject on which the system 100 is positioned. Method 1800 also includes comparing the one or more identity sense signals to reference data indicative of one or more physical characteristics associated with an identity of at least one individual in block 1804. For example, the circuitry 106 can compare (e.g., via comparison module 400, via comparison
10 module 1000, etc.) the identity sense signals to reference data stored in memory (e.g., memory 402), where the reference data includes physical characteristics linked or associated with an identity of a known individual. Where the identity sense signals meet or exceed a threshold correspondence when compared to the reference data, the identity linked or associated with the physical characteristics
15 stored in memory can be correlated to the individual subject on which the system 100 is positioned (i.e., the individual subject can be presumed to have the known identity based on a successful correspondence). Where the identity sense signals do not meet a threshold correspondence when compared to the reference data, the identity linked or associated with the physical characteristics stored in memory
20 cannot be correlated to the individual subject on which the system 100 is positioned (i.e., the individual subject is not presumed to have the known identity based on the unsuccessful correspondence). Method 1800 also includes transitioning an adhesive from an adhesive state to a non-adhesive state upon determination that the identity sense signals do not provide a threshold
25 correspondence to the physical characteristics in block 1806. For example, the circuitry 106 can generate one or more energy signals to interact with the adhesive 1300 to transition the adhesive 1300 from an adhesive state to a non-adhesive state when the identity of the individual subject on which the system 100 is positioned cannot be determined within a particular threshold correspondence.
30 In such circumstances, the system 100 may no longer be positioned on the individual subject due to an inability of the adhesive 1300 to maintain a suitable connection to a skin surface of the individual subject when in the non-adhesive state.

FIG. 19 illustrates a method 1900 for adjusting an adhesive state of an adhesive responsive to identification of an individual using conformable electronics. Method 1900 shows generating one or more identity sense signals in block 1902, where the sense signals correspond to an individual subject and are generated by an identification device having a deformable substrate and at least one identity sensor coupled to the deformable substrate. For example, the sensor assembly 104 (e.g., one or more identity sensors 200) can generate one or more identity sense signals associated with an individual subject on which the system 100 is positioned. Method 1900 also includes comparing the one or more identity sense signals to reference data indicative of one or more physical characteristics associated with an identity of at least one individual in block 1904. For example, the circuitry 106 can compare (e.g., via comparison module 400, via comparison module 1000, etc.) the identity sense signals to reference data stored in memory (e.g., memory 402), where the reference data includes physical characteristics linked or associated with an identity of a known individual. Where the identity sense signals meet or exceed a threshold correspondence when compared to the reference data, the identity linked or associated with the physical characteristics stored in memory can be correlated to the individual subject on which the system 100 is positioned (i.e., the individual subject can be presumed to have the known identity based on a successful correspondence). Where the identity sense signals do not meet a threshold correspondence when compared to the reference data, the identity linked or associated with the physical characteristics stored in memory cannot be correlated to the individual subject on which the system 100 is positioned (i.e., the individual subject is not presumed to have the known identity based on the unsuccessful correspondence). Method 1900 also includes transitioning an adhesive from a non-adhesive state to an adhesive state upon determination that the identity sense signals provide a threshold correspondence to the physical characteristics in block 1906. For example, the circuitry 106 can generate one or more energy signals to interact with the adhesive 1300 to transition the adhesive 1300 from a non-adhesive state to an adhesive state when the identity of the individual subject on which the system 100 is positioned can be determined within a particular threshold correspondence. For example, the system 100 may be manually positioned or held against the body portion of an

individual subject to permit the sensor assembly 104 to generate the identity sense signals, which when the identity can be determined, the adhesive 1300 can transition from the non-adhesive state to an adhesive state (e.g., via interaction with the energy signals from the circuitry 106) to maintain a suitable connection to a skin surface of the individual subject, such as to fix the system 100 in place on an identified individual.

In an embodiment, the system 100 is configured as an authorized key or pass. For example, an individual subject can utilize a system described herein to gain access to a building (e.g., clinic, hospital, ER, care facility), room, or kiosk, and to interface with systems therein. The individual subject can utilize a system described herein to gain access to a local gym and interface with its system. The individual subject's identity can be recognized, and the individual subject can be directed to particular exercise equipment or classes specific for that individual subject. The individual subject can also receive feedback once interacting or engaging with the exercise equipment or, for example, doing exercises in front of a mirror or mat with sensors. Thus, the individual subject can receive physical therapy, occupational therapy, or customized exercises specifically tailored to him or her by utilizing a system described herein. Further, the system can make product or service recommendations to the individual subject based on the subject's profile. For example, nutrition products or athletic gear or exercise services can be tailored to the individual subject as selected advertising or promotional offers (coupons, etc.). For example, an individual subject can utilize a system as a transportation pass, such as a bus pass, boarding ticket, or venue ticket. After using the pass, the individual subject's identity can be recognized, and the individual subject can be directed to particular seat. Further, the system can make product or service recommendations to the individual subject based on the subject's profile, for example suggesting a pair of headphones useful for the venue or a particular beverage tailored to the individual subject as selected advertising.

As an example, an individual subject can utilize a system described herein to gain access to one or more piece of equipment such as that described herein. In this regard, the system can identify the individual and activate the transmission

by the system so as to act as a key for any of several pieces of equipment configured to receive the predetermined transmission.

As an example, an individual subject can utilize a system described herein to interface with other information or sensor systems for collecting and
5 transmitting data. For example, health sensors worn by an individual subject can interface with the system, which identifies the individual subject and controls data transmission. Identity is authenticated and transmission is allowed, e.g., to a health care record or daily activity record specific to the individual subject. The transmission includes information associating data with the individual subject.
10 The system can further provide recommendations for products or services based on the data (e.g., a recommendation to see a health care provider or have a prescription filled) and can interface with a third party, such as a health care provider's office or pharmacy, to schedule an appointment or place an order, using the identity and authentication.

15 Certain embodiments are described herein as including logic or a number of components, modules, or mechanisms. Modules may constitute software modules (e.g., code stored or otherwise embodied on a machine-readable medium or in a transmission medium), hardware modules, or any suitable combination thereof. A "hardware module" is a tangible (e.g., non-transitory) unit
20 capable of performing certain operations and may be configured or arranged in a certain physical manner. In various example embodiments, one or more computer systems (e.g., a standalone computer system, a client computer system, or a server computer system) or one or more hardware modules of a computer system (e.g., a processor or a group of processors) may be configured by software (e.g.,
25 an application or application portion) as a hardware module that operates to perform certain operations as described herein.

In some embodiments, a hardware module may be implemented mechanically, electronically, or any suitable combination thereof. For example, a hardware module may include dedicated circuitry or logic that is permanently
30 configured to perform certain operations. For example, a hardware module may be a special-purpose processor, such as a field programmable gate array (FPGA) or an ASIC. A hardware module may also include programmable logic or circuitry that is temporarily configured by software to perform certain operations. For

example, a hardware module may include software encompassed within a general-purpose processor or other programmable processor. It will be appreciated that the decision to implement a hardware module mechanically, in dedicated and permanently configured circuitry, or in temporarily configured
5 circuitry (e.g., configured by software) may be driven by cost and time considerations.

Accordingly, the phrase "hardware module" should be understood to encompass a tangible entity, and such a tangible entity may be physically constructed, permanently configured (e.g., hardwired), or temporarily configured
10 (e.g., programmed) to operate in a certain manner or to perform certain operations described herein. Considering embodiments in which hardware modules are temporarily configured (e.g., programmed), each of the hardware modules need not be configured or instantiated at any one instance in time. For example, where a hardware module comprises a general-purpose processor configured by
15 software to become a special-purpose processor, the general-purpose processor may be configured as respectively different special-purpose processors (e.g., comprising different hardware modules) at different times. Software (e.g., a software module) may accordingly configure one or more processors, for example, to constitute a particular hardware module at one instance of time and to
20 constitute a different hardware module at a different instance of time.

Hardware modules can provide information to, and receive information from, other hardware modules. Accordingly, the described hardware modules may be regarded as being communicatively coupled. Where multiple hardware
modules exist contemporaneously, communications may be achieved through
25 signal transmission (e.g., over appropriate circuits and buses) between or among two or more of the hardware modules. In embodiments in which multiple hardware modules are configured or instantiated at different times, communications between such hardware modules may be achieved, for example, through the
storage and retrieval of information in memory structures to which the multiple
30 hardware modules have access. For example, one hardware module may perform an operation and store the output of that operation in a memory device to which it is communicatively coupled. A further hardware module may then, at a later time, access the memory device to retrieve and process the stored output. Hardware

modules may also initiate communications with input or output devices, and can operate on a resource (e.g., a collection of information).

The state of the art has progressed to the point where there is little distinction left between hardware, software, and/or firmware implementations of
5 aspects of systems; the use of hardware, software, and/or firmware is generally (but not always, in that in certain contexts the choice between hardware and software can become significant) a design choice representing cost vs. efficiency tradeoffs. There are various vehicles by which processes and/or systems and/or
10 other technologies described herein can be effected (e.g., hardware, software, and/or firmware), and that the preferred vehicle will vary with the context in which the processes and/or systems and/or other technologies are deployed. For example, if an implementer determines that speed and accuracy are paramount, the implementer may opt for a mainly hardware and/or firmware vehicle; alternatively, if flexibility is paramount, the implementer may opt for a mainly
15 software implementation; or, yet again alternatively, the implementer may opt for some combination of hardware, software, and/or firmware. Hence, there are several possible vehicles by which the processes and/or devices and/or other technologies described herein can be effected, none of which is inherently superior to the other in that any vehicle to be utilized is a choice dependent upon
20 the context in which the vehicle will be deployed and the specific concerns (e.g., speed, flexibility, or predictability) of the implementer, any of which may vary. Those skilled in the art will recognize that optical aspects of implementations will typically employ optically-oriented hardware, software, and or firmware.

In some implementations described herein, logic and similar
25 implementations can include software or other control structures. Electronic circuitry, for example, may have one or more paths of electrical current constructed and arranged to implement various functions as described herein. In some implementations, one or more media can be configured to bear a device-detectable implementation when such media hold or transmit device detectable
30 instructions operable to perform as described herein. In some variants, for example, implementations can include an update or modification of existing software or firmware, or of gate arrays or programmable hardware, such as by performing a reception of or a transmission of one or more instructions in relation

to one or more operations described herein. Alternatively or additionally, in some variants, an implementation can include special-purpose hardware, software, firmware components, and/or general-purpose components executing or otherwise invoking special-purpose components. Specifications or other
5 implementations can be transmitted by one or more instances of tangible transmission media as described herein, optionally by packet transmission or otherwise by passing through distributed media at various times.

Alternatively or additionally, implementations may include executing a special-purpose instruction sequence or otherwise invoking circuitry for enabling,
10 triggering, coordinating, requesting, or otherwise causing one or more occurrences of any functional operations described above. In some variants, operational or other logical descriptions herein may be expressed directly as source code and compiled or otherwise invoked as an executable instruction sequence. In some contexts, for example, C++ or other code sequences can be
15 compiled directly or otherwise implemented in high-level descriptor languages (e.g., a logic-synthesizable language, a hardware description language, a hardware design simulation, and/or other such similar mode(s) of expression). Alternatively or additionally, some or all of the logical expression may be manifested as a Verilog-type hardware description or other circuitry model before
20 physical implementation in hardware, especially for basic operations or timing-critical applications.

The foregoing detailed description has set forth various embodiments of the devices and/or processes via the use of block diagrams, flowcharts, and/or examples. Insofar as such block diagrams, flowcharts, and/or examples contain
25 one or more functions and/or operations, each function and/or operation within such block diagrams, flowcharts, or examples can be implemented, individually and/or collectively, by a wide range of hardware, software, firmware, or virtually any combination thereof. In one embodiment, several portions of the subject matter described herein can be implemented via Application Specific Integrated
30 Circuits (ASICs), Field Programmable Gate Arrays (FPGAs), digital signal processors (DSPs), or other integrated formats. However, some aspects of the embodiments disclosed herein, in whole or in part, can be equivalently implemented in integrated circuits, as one or more computer programs running on

one or more computers (e.g., as one or more programs running on one or more computer systems), as one or more programs running on one or more processors (e.g., as one or more programs running on one or more microprocessors), as firmware, or as virtually any combination thereof, and that designing the circuitry
5 and/or writing the code for the software and or firmware would be well within the skill of one of skill in the art in light of this disclosure. In addition, the mechanisms of the subject matter described herein are capable of being distributed as a program product in a variety of forms, and that an illustrative embodiment of the subject matter described herein applies regardless of the particular type of signal
10 bearing medium used to actually carry out the distribution.

In a general sense, the various embodiments described herein can be implemented, individually and/or collectively, by various types of electro-mechanical systems having a wide range of electrical components such as hardware, software, firmware, and/or virtually any combination thereof and a wide
15 range of components that may impart mechanical force or motion such as rigid bodies, spring or torsional bodies, hydraulics, electro-magnetically actuated devices, and/or virtually any combination thereof. Consequently, as used herein "electro-mechanical system" includes, but is not limited to, electrical circuitry operably coupled with a transducer (e.g., an actuator, a motor, a piezoelectric
20 crystal, a Micro Electro Mechanical System (MEMS), etc.), electrical circuitry having at least one discrete electrical circuit, electrical circuitry having at least one integrated circuit, electrical circuitry having at least one application specific integrated circuit, electrical circuitry forming a general purpose computing device configured by a computer program (e.g., a general purpose computer configured
25 by a computer program which at least partially carries out processes and/or devices described herein, or a microprocessor configured by a computer program which at least partially carries out processes and/or devices described herein), electrical circuitry forming a memory device (e.g., forms of memory (e.g., random access, flash, read only, etc.)), electrical circuitry forming a communications
30 device (e.g., a modem, communications switch, optical-electrical equipment, etc.), and/or any non-electrical analog thereto, such as optical or other analogs. Examples of electro-mechanical systems include but are not limited to a variety of consumer electronics systems, medical devices, as well as other systems such as

motorized transport systems, factory automation systems, security systems, and/or communication/computing systems. Electro-mechanical as used herein is not necessarily limited to a system that has both electrical and mechanical actuation except as context may dictate otherwise.

5 In a general sense, the various aspects described herein can be implemented, individually and/or collectively, by a wide range of hardware, software, firmware, and/or any combination thereof and can be viewed as being composed of various types of "electrical circuitry." Consequently, as used herein "electrical circuitry" includes, but is not limited to, electrical circuitry having at least
10 one discrete electrical circuit, electrical circuitry having at least one integrated circuit, electrical circuitry having at least one application specific integrated circuit, electrical circuitry forming a general purpose computing device configured by a computer program (e.g., a general purpose computer configured by a computer program which at least partially carries out processes and/or devices described
15 herein, or a microprocessor configured by a computer program which at least partially carries out processes and/or devices described herein), electrical circuitry forming a memory device (e.g., forms of memory (e.g., random access, flash, read only, etc.)), and/or electrical circuitry forming a communications device (e.g., a modem, communications switch, optical-electrical equipment, etc.). The subject
20 matter described herein can be implemented in an analog or digital fashion or some combination thereof.

 With respect to the use of substantially any plural and/or singular terms herein, the plural can be translated to the singular and/or from the singular to the plural as is appropriate to the context and/or application. The various
25 singular/plural permutations are not expressly set forth herein for sake of clarity.

 The herein described subject matter sometimes illustrates different components contained within, or connected with, different other components. It is to be understood that such depicted architectures are merely exemplary, and that in fact many other architectures can be implemented which achieve the same
30 functionality. In a conceptual sense, any arrangement of components to achieve the same functionality is effectively "associated" such that the desired functionality is achieved. Hence, any two components herein combined to achieve a particular functionality can be seen as "operably coupled to" each other such that the

desired functionality is achieved, irrespective of architectures or intermedial components. Likewise, any two components so associated can also be viewed as being "operably connected," or "operably coupled," to each other to achieve the desired functionality, and any two components capable of being so associated can
5 also be viewed as being "operably couplable," to each other to achieve the desired functionality. Specific examples of operably couplable include but are not limited to physically mateable and/or physically interacting components, and/or wirelessly interactable, and/or wirelessly interacting components, and/or logically interacting, and/or logically interactable components.

10 In some instances, one or more components can be referred to herein as "configured to," "configured by," "configurable to," "operable/operative to," "adapted/adaptable," "able to," "conformable/conformed to," etc. Those skilled in the art will recognize that such terms (e.g. "configured to") can generally encompass active-state components and/or inactive-state components and/or
15 standby-state components, unless context requires otherwise.

In general, terms used herein, and especially in the appended claims (e.g., bodies of the appended claims) are generally intended as "open" terms (e.g., the term "including" should be interpreted as "including but not limited to," the term "having" should be interpreted as "having at least," the term "includes" should be
20 interpreted as "includes but is not limited to," etc.). If a specific number of an introduced claim recitation is intended, such an intent will be explicitly recited in the claim, and in the absence of such recitation no such intent is present. For example, as an aid to understanding, the following appended claims may contain usage of the introductory phrases "at least one" and "one or more" to introduce
25 claim recitations. However, the use of such phrases should not be construed to imply that the introduction of a claim recitation by the indefinite articles "a" or "an" limits any particular claim containing such introduced claim recitation to claims containing only one such recitation, even when the same claim includes the introductory phrases "one or more" or "at least one" and indefinite articles such as
30 "a" or "an" (e.g., "a" and/or "an" should typically be interpreted to mean "at least one" or "one or more"); the same holds true for the use of definite articles used to introduce claim recitations. In addition, even if a specific number of an introduced claim recitation is explicitly recited, those skilled in the art will recognize that such

recitation should typically be interpreted to mean at least the recited number (e.g., the bare recitation of "two recitations," without other modifiers, typically means at least two recitations, or two or more recitations). Furthermore, in those instances where a convention analogous to "at least one of A, B, and C, etc." is used, in
5 general such a construction is intended in the sense one having skill in the art would understand the convention (e.g., "a system having at least one of A, B, and C" would include but not be limited to systems that have A alone, B alone, C alone, A and B together, A and C together, B and C together, and/or A, B, and C together, etc.). In those instances where a convention analogous to "at least one
10 of A, B, or C, etc." is used, in general such a construction is intended in the sense one having skill in the art would understand the convention (e.g., "a system having at least one of A, B, or C" would include but not be limited to systems that have A alone, B alone, C alone, A and B together, A and C together, B and C together, and/or A, B, and C together, etc.). Typically a disjunctive word and/or phrase
15 presenting two or more alternative terms, whether in the description, claims, or drawings, should be understood to contemplate the possibilities of including one of the terms, either of the terms, or both terms unless context dictates otherwise. For example, the phrase "A or B" will be typically understood to include the possibilities of "A" or "B" or "A and B."

20 This disclosure has been made with reference to various example embodiments. However, those skilled in the art will recognize that changes and modifications may be made to the embodiments without departing from the scope of the present disclosure. For example, various operational steps, as well as components for carrying out operational steps, may be implemented in alternate
25 ways depending upon the particular application or in consideration of any number of cost functions associated with the operation of the system; e.g., one or more of the steps may be deleted, modified, or combined with other steps.

Additionally, as will be appreciated by one of ordinary skill in the art, principles of the present disclosure, including components, may be reflected in a
30 computer program product on a computer-readable storage medium having computer-readable program code means embodied in the storage medium. Any tangible, non-transitory computer-readable storage medium may be utilized, including magnetic storage devices (hard disks, floppy disks, and the like), optical

storage devices (CD-ROMs, DVDs, Blu-ray discs, and the like), flash memory, and/or the like. These computer program instructions may be loaded onto a general purpose computer, special purpose computer, or other programmable data processing apparatus to produce a machine, such that the instructions that
5 execute on the computer or other programmable data processing apparatus create a means for implementing the functions specified. These computer program instructions may also be stored in a computer-readable memory that can direct a computer or other programmable data processing apparatus to function in a particular manner, such that the instructions stored in the computer-readable
10 memory produce an article of manufacture, including implementing means that implement the function specified. The computer program instructions may also be loaded onto a computer or other programmable data processing apparatus to cause a series of operational steps to be performed on the computer or other programmable apparatus to produce a computer-implemented process, such that
15 the instructions that execute on the computer or other programmable apparatus provide steps for implementing the functions specified.

The foregoing specification has been described with reference to various embodiments. However, one of ordinary skill in the art will appreciate that various modifications and changes can be made without departing from the scope of the
20 present disclosure. Accordingly, this disclosure is to be regarded in an illustrative rather than a restrictive sense, and all such modifications are intended to be included within the scope thereof. Likewise, benefits, other advantages, and solutions to problems have been described above with regard to various
25 embodiments. However, benefits, advantages, solutions to problems, and any element(s) that may cause any benefit, advantage, or solution to occur or become more pronounced are not to be construed as a critical, a required, or an essential feature or element. As used herein, the terms “comprises,” “comprising,” and any other variation thereof are intended to cover a non-exclusive inclusion, such that a
30 process, a method, an article, or an apparatus that comprises a list of elements does not include only those elements but may include other elements not expressly listed or inherent to such process, method, system, article, or apparatus.

In embodiments, the system is integrated in such a manner that the system operates as a unique system configured specifically for function of one or more of the systems described herein (e.g., system 100) used to identify and/or authorize individual, such as to operate external devices (e.g., external device 800), and any associated computing devices of the system operate as specific use computers for purposes of the claimed system, and not general use computers. In 5 embodiments, at least one associated computing device of the system operates as a specific use computer for purposes of the claimed system, and not a general use computer. In embodiments, at least one of the associated computing devices 10 of the system is hardwired with a specific ROM to instruct the at least one computing device. In embodiments, one of skill in the art recognizes that the systems described herein (e.g., system 100) and associated systems/devices effect an improvement at least in the technological field(s) of identification and/or authorization.

15 While various aspects and embodiments have been disclosed herein, other aspects and embodiments will be apparent to those skilled in the art. The various aspects and embodiments disclosed herein are for purposes of illustration and are not intended to be limiting, with the true scope and spirit being indicated by the following claims.

CLAIMS

1. An identification device, comprising:
a deformable substrate configured to conform to a skin surface of a body portion of an individual subject;
- 5 a sensor assembly coupled to the deformable substrate, the sensor assembly including one or more identity sensors configured to generate one or more identity sense signals associated with at least one physical characteristic of the individual subject;
- 10 circuitry operably coupled to the sensor assembly and configured to receive the one or more identity sense signals associated with the at least one physical characteristic of the individual subject, the circuitry including a comparison module configured to compare the one or more identity sense signals generated by the sensor assembly to reference data indicative of one or more physical characteristics associated with an identity of at least one
- 15 individual; and
- an adhesive coupled to a surface of the deformable substrate and configured to adhere the deformable substrate to the skin surface, the adhesive configured to transition from an adhesive state to a non-adhesive state responsive to one or more energy signals from the circuitry, the circuitry configured to
- 20 generate the one or more energy signals responsive to a correspondence between the one or more identity sense signals and the one or more physical characteristics associated with the identity of the at least one individual being below a threshold correspondence.
2. The identification device of claim 1, wherein the adhesive includes an
- 25 electroactive polymer actuatable by the one or more energy signals from the circuitry to transition from the adhesive state to the non-adhesive state.
3. The identification device of claim 1, wherein the adhesive includes a thermo-responsive adhesive actuatable by a change in temperature of the adhesive responsive to the one or more energy signals from the circuitry to transition from
- 30 the adhesive state to the non-adhesive state.
4. The identification device of claim 1, wherein the adhesive includes a magnetic-responsive adhesive responsive to the one or more energy signals from the circuitry to transition from the adhesive state to the non-adhesive state.

5. The identification device of claim 1, wherein the adhesive includes a light-responsive adhesive responsive to the one or more energy signals from the circuitry to transition from the adhesive state to the non-adhesive state.

6. The identification device of claim 1, wherein the adhesive includes a
5 reversible microstructure configured to transition between the adhesive state and the non-adhesive state responsive to the one or more energy signals from the circuitry.

7. The identification device of claim 6, wherein the reversible
10 microstructure is configured to reversibly transition between the adhesive state and the non-adhesive state responsive to the one or more energy signals from the circuitry.

8. The identification device of claim 1, further including:
at least one reservoir configured to release an adherence mitigator responsive to
the one or more energy signals from the circuitry, the adherence mitigator
15 configured to interact with the adhesive to transition the adhesive from the adhesive state to the non-adhesive state.

9. The identification device of claim 8, wherein the adherence mitigator includes at least one of a fluid material or a powdered material.

10. The identification device of claim 8, wherein the adhesive is
20 configured to transition from the non-adhesive state to the adhesive state upon removal of the adherence mitigator.

11. The identification device of claim 8, wherein the adherence mitigator is configured to degrade at least a portion of at least one of the adhesive, the deformable substrate, the sensor assembly, or the circuitry.

12. The identification device of claim 1, further including:
25 at least one reservoir configured to release an adherence promotor responsive to the one or more energy signals from the circuitry, the adherence mitigator configured to interact with the adhesive to transition the adhesive from the adhesive state to the non-adhesive state.

13. An identification device, comprising:
30 a deformable substrate configured to conform to a skin surface of a body portion of an individual subject;

a sensor assembly coupled to the deformable substrate, the sensor assembly including one or more identity sensors configured to generate one or more identity sense signals associated with at least one physical characteristic of the individual subject;

5 circuitry operably coupled to the sensor assembly and configured to receive the one or more identity sense signals associated with the at least one physical characteristic of the individual subject, the circuitry including a comparison module configured to compare the one or more identity sense signals generated by the sensor assembly to reference data indicative of one or
10 more physical characteristics associated with an identity of at least one individual; and

an adhesive coupled to a surface of the deformable substrate and configured to adhere the deformable substrate to the skin surface, the adhesive configured to transition from a non-adhesive state to an adhesive state responsive to
15 one or more energy signals from the circuitry, the circuitry configured to generate the one or more energy signals responsive to a correspondence between the one or more identity sense signals and the one or more physical characteristics associated with the identity of the at least one individual being at least at a threshold correspondence.

20 14. The identification device of claim 13, wherein the adhesive includes an electroactive polymer actuatable by the one or more energy signals from the circuitry to transition from the non-adhesive state to the adhesive state.

15 15. The identification device of claim 13, wherein the adhesive includes a thermo-responsive adhesive actuatable by a change in temperature of the adhesive responsive to the one or more energy signals from the circuitry to transition from the non-adhesive state to the adhesive state.

16. The identification device of claim 13, wherein the adhesive includes a magnetic-responsive adhesive responsive to the one or more energy signals from the circuitry to transition from the non-adhesive state to the adhesive state.

30 17. The identification device of claim 13, wherein the adhesive includes a light-responsive adhesive responsive to the one or more energy signals from the circuitry to transition from the non-adhesive state to the adhesive state.

18. The identification device of claim 13, wherein the adhesive includes a reversible microstructure configured to transition between the non-adhesive state and the adhesive state responsive to the one or more energy signals from the circuitry.

5 19. The identification device of claim 13, further including:
at least one reservoir configured to release an adherence mitigator responsive to the one or more energy signals from the circuitry, the adherence mitigator configured to interact with the adhesive to transition the adhesive from the non-adhesive state to the adhesive state.

10 20. The identification device of claim 13, further including:
at least one reservoir configured to release an adherence promotor responsive to the one or more energy signals from the circuitry, the adherence mitigator configured to interact with the adhesive to transition the adhesive from the non-adhesive state to the adhesive state.

15 21. An identification device, comprising:
a deformable substrate configured to conform to a skin surface of a body portion of an individual subject;
a sensor assembly coupled to the deformable substrate, the sensor assembly including one or more identity sensors configured to generate one or more
20 identity sense signals associated with at least one physical characteristic of the individual subject;
circuitry operably coupled to the sensor assembly and configured to receive the one or more identity sense signals associated with the at least one physical characteristic of the individual subject, the circuitry including a comparison
25 module configured to compare the one or more identity sense signals generated by the sensor assembly to reference data indicative of one or more physical characteristics associated with an identity or physical state of at least one individual to determine whether the one or more identity signals correspond to the identity of the at least one individual; and
30 a reporter operably coupled to the circuitry and configured to generate one or more communication signals responsive to instruction by the circuitry, the one or more communication signals associated with at least one of the one or more identity sense signals or a comparison of the one or more identity sense

signals with the at least one of the one or more physical characteristics associated with the identity of the at least one individual, the one or more authorization parameters or the identity of an individual with the one or more authorization parameters.

5 22. The identification device of claim 21, including at least one flexible or stretchable electronic component.

 23. The identification device of claim 22, wherein the at least one flexible or stretchable electronic component includes at least one of a wavy, bent, mesh, or serpentine geometry.

10 24. The identification device of claim 23, wherein the at least one flexible or stretchable electronic component includes at least one nanowire, at least one nanoribbon, or at least one nanomembrane.

 25. The device of claim 21, wherein the reporter includes a display device having one or more light emitting elements configured to provide a predetermined
15 pattern of light corresponding to a comparison between at least one of the one or more identity sense signals with the one or more authorization parameters or the identity of the at least one individual with the one or more authorization parameters.

 26. The device of claim 27, wherein the predetermined pattern includes a
20 first pattern associated with a correspondence between at least one of the one or more identity sense signals with the one or more authorization parameters or the identity of the at least one individual with the one or more authorization parameters being below a threshold correspondence, and wherein the predetermined pattern includes a second pattern associated with a correspondence between at least one
25 of the one or more identity sense signals with the one or more authorization parameters or the identity of the at least one individual with the one or more authorization parameters being at least at the threshold correspondence.

 27. The device of claim 21, wherein the circuitry is configured to determine whether the deformable substrate has been removed from the skin surface of the individual subject.

30 28. The device of claim 27, wherein the sensor assembly includes at least one of a strain gauge or a proximity sensor configured to sense whether the deformable substrate has been removed from the skin surface of the individual subject.

29. The device of claim 28, wherein the circuitry is configured to determine whether the deformable substrate has been applied to a skin surface that differs from the skin surface of the individual subject.

30. The device of claim 21, wherein the circuitry is configured to disable at
5 least one component of the device responsive to a correspondence between the one or more identity sense signals and the reference data indicative of one or more physical characteristics associated with the identity of the at least one individual being below a threshold correspondence.

31. The device of claim 21, wherein the one or more communication signals
10 correspond to a lack of authorization of the individual subject to operate an external device responsive to a correspondence between the one or more identity sense signals and the reference data indicative of one or more physical characteristics associated with the identity of the at least one individual being below a threshold correspondence.

32. The device of claim 21, wherein the one or more communication
15 signals correspond to authorization of the individual subject to operate an external device responsive to both of (i) a correspondence between the one or more identity sense signals and the reference data indicative of one or more physical characteristics associated with the identity of the at least one individual being at
20 least at a threshold correspondence and (ii) a correspondence between at least one of the one or more identity sense signals or the identity of the at least one individual with one or more authorization parameters being at least at a threshold correspondence.

33. The identification device of claim 21, wherein the deformable
25 substrate includes a gas-permeable elastomeric sheet.

34. The identification device of claim 21, wherein the one or more identity sensors include at least one of an optical sensor, an electromagnetic sensor, an impedance sensor, or a capacitive sensor.

35. The identification device of claim 21, wherein the one or more identity
30 sensors include at least one of an electrophysiological sensor, a plethysmographic sensor, a resistive sensor, a biosensor, or a chemical sensor.

36. The identification device of claim 21, wherein the at least one physical characteristic includes a skin topography feature.

37. The identification device of claim 21, further including:
one or more physiological sensors.

38. The identification device of claim 21, further including:
5 at least one of a proximity sensor, a contact sensor, a pressure sensor, or a
temperature sensor.

39. The identification device of claim 21, wherein the circuitry is
configured to disable at least one component of the identification device responsive
to a correspondence between the one or more identity sense signals and the one
10 or more physical characteristics associated with the identity of the at least one
individual being below a threshold correspondence.

40. The identification device of claim 21, wherein the circuitry is
configured to permit operation of at least one component of the identification device
responsive to a correspondence between the one or more identity sense signals
15 and the one or more physical characteristics associated with the identity of the at
least one individual being at least at a threshold correspondence.

41. The identification device of claim 40, wherein the circuitry is
configured to activate a power connection to the reporter responsive to the
correspondence between the one or more identity sense signals and the one or
20 more physical characteristics associated with the identity of the at least one
individual being at least at the threshold correspondence.

42. The identification device of claim 21, wherein one or more of the
sensor assembly, the circuitry, or the reporter is communicatively coupled with an
external device that is resident on the individual subject.

25 43. A system, comprising:
an identification device including
a deformable substrate configured to conform to a skin surface of a body
portion of an individual subject;
a sensor assembly coupled to the deformable substrate, the sensor
30 assembly including one or more identity sensors configured to
generate one or more identity sense signals associated with at least
one physical characteristic of the individual subject;

5 circuitry operably coupled to the sensor assembly and configured to receive the one or more identity sense signals associated with the at least one physical characteristic of the individual subject, the circuitry including a comparison module configured to compare the one or more identity sense signals generated by the sensor assembly to reference data indicative of one or more physical characteristics associated with an identity of at least one individual; and

10 a reporter operably coupled to the circuitry and configured to generate one or more communication signals responsive to instruction by the circuitry, the one or more communication signals associated with at least one of the one or more identity sense signals or a comparison of the one or more identity sense signals with the one or more physical characteristics associated with the identity of the at least one individual; and

15 an external device operably coupled to the identification device, the external device including

20 a receiver configured to receive the one or more communication signals from the reporter of the identification device; and circuitry configured to compare the one or more communication signals with one or more authorization parameters associated with one or more users authorized to operate the external device.

25 44. The system of claim 43, wherein the one or more authorization parameters include a list of identities one or more users authorized to operate the external device.

45. The system of claim 44, wherein the one or more authorization parameters include a list of reference physical characteristics for one or more users authorized to operate the external device.

30 46. The system of claim 43, wherein the one or more identity sense signals include at least one of an electric current pattern, a photovoltaic current pattern, or a skin resistivity measurement.

47. The system of claim 43, wherein at least one of the reporter, the sensor assembly, or the circuitry includes at least one of a receiver or a transceiver configured to receive one or more communication signals from an external device, wherein the one or more communication signals from an external device are
5 associated with at least one of control programming, reference data, or a query.

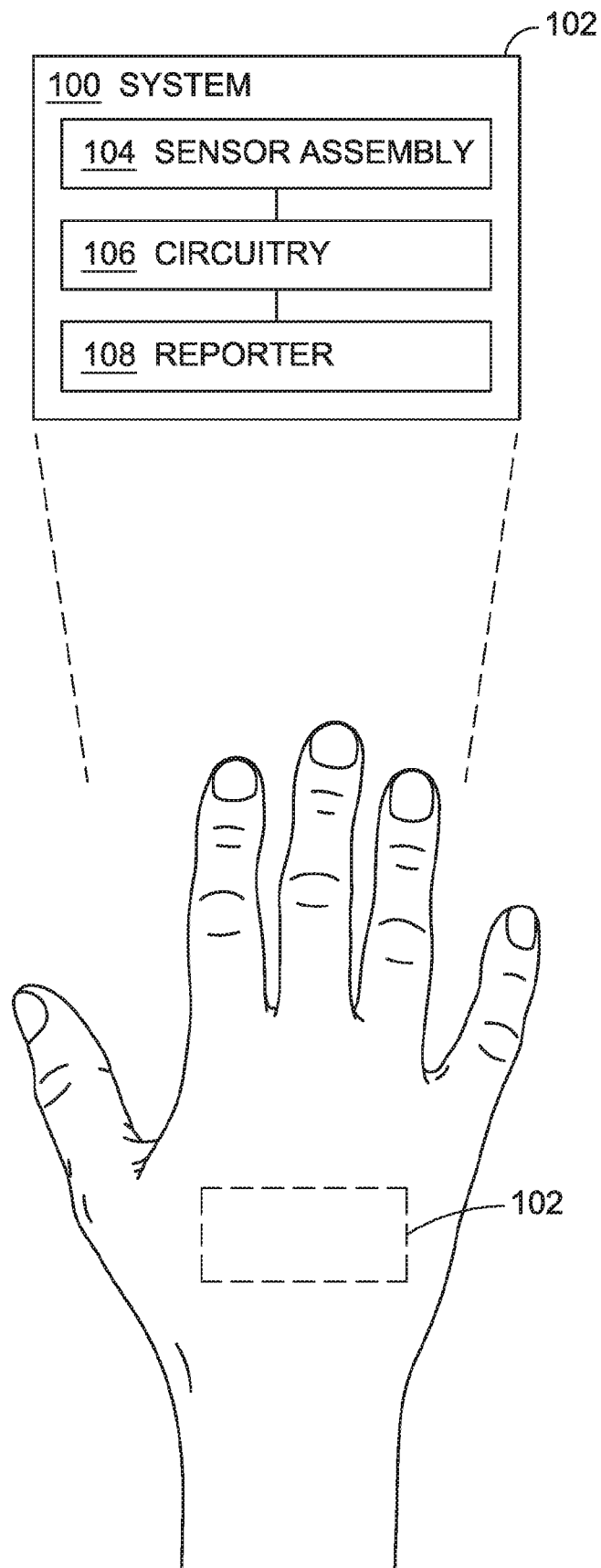

FIG. 1

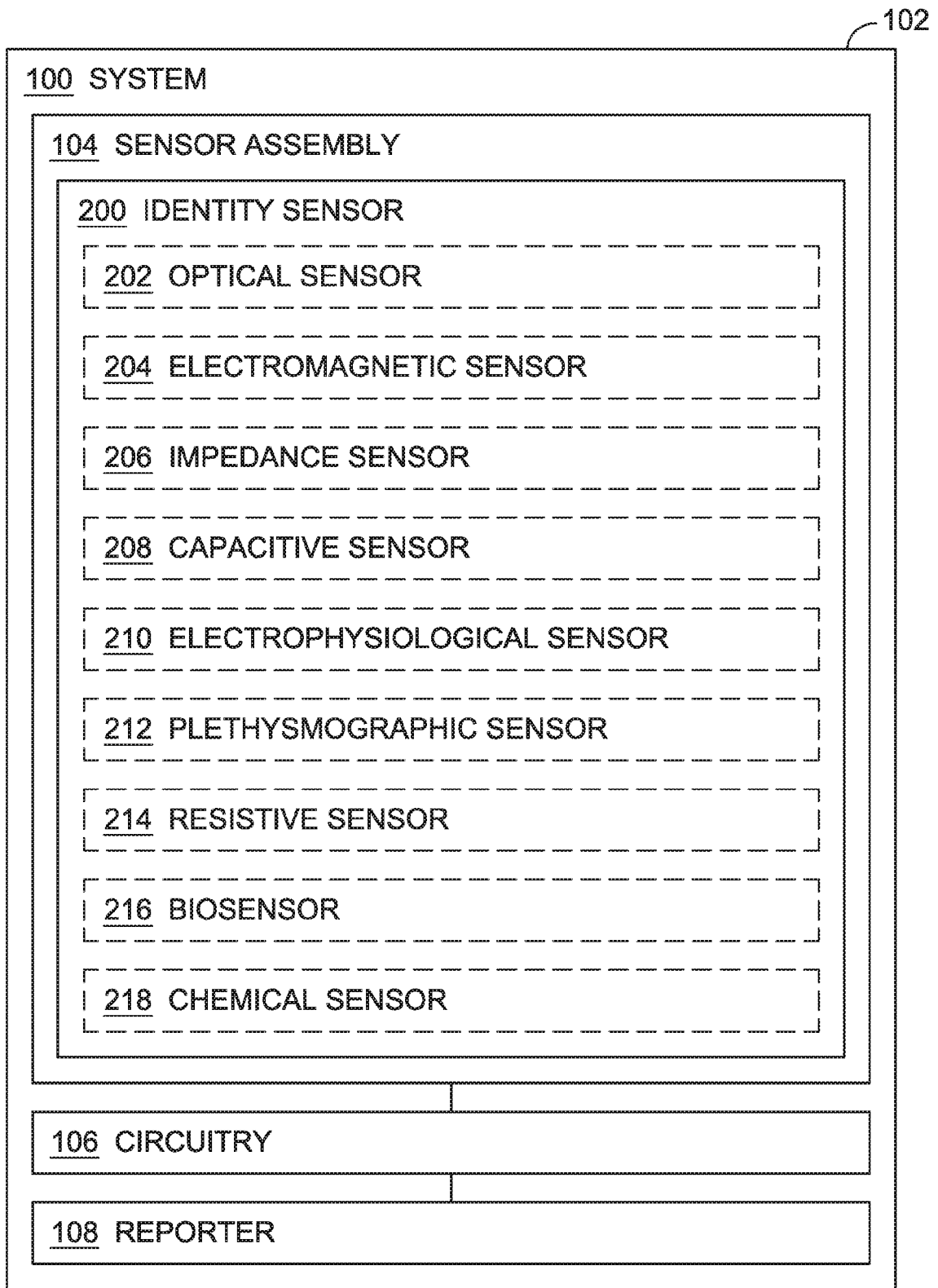

FIG. 2

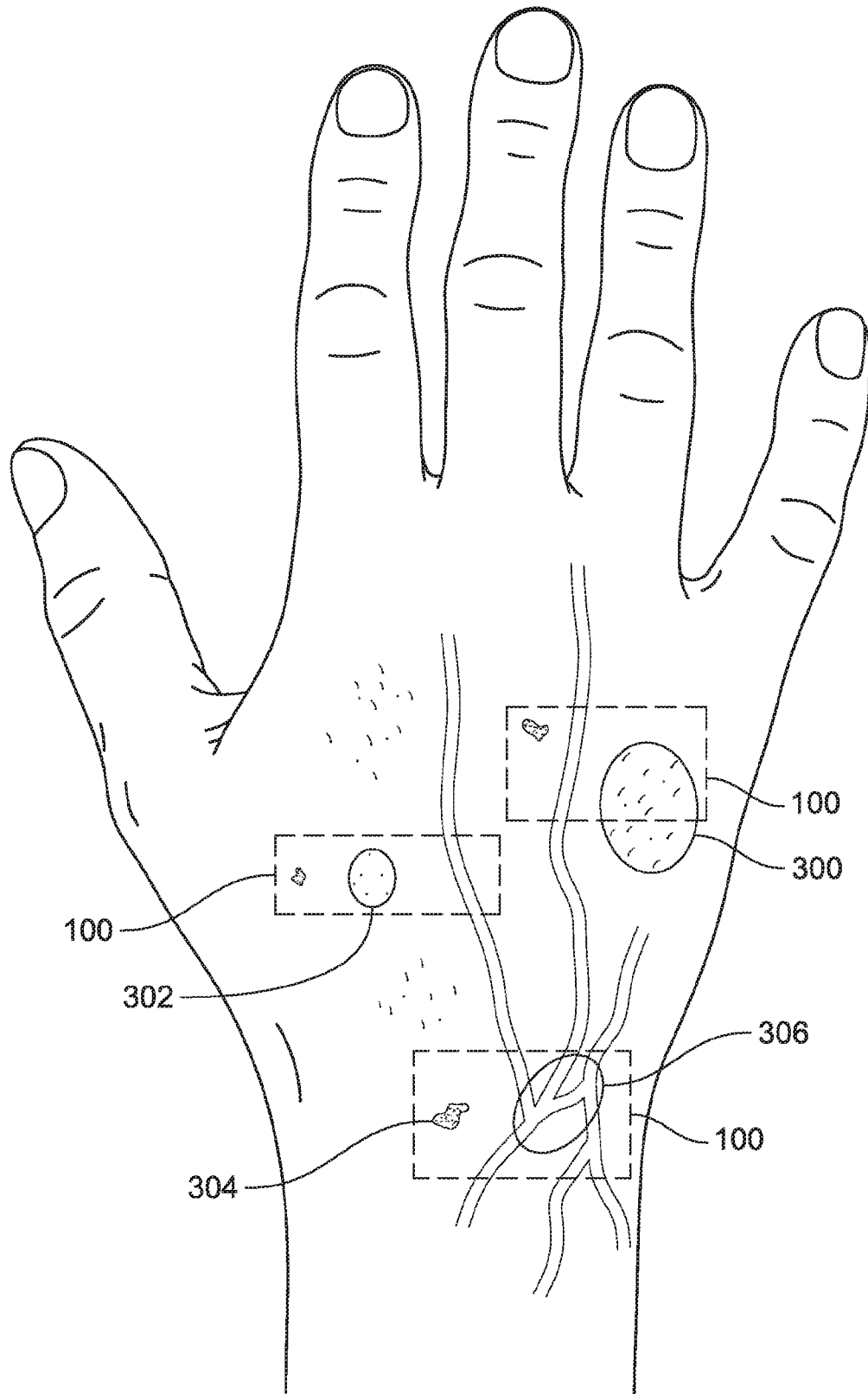

FIG. 3

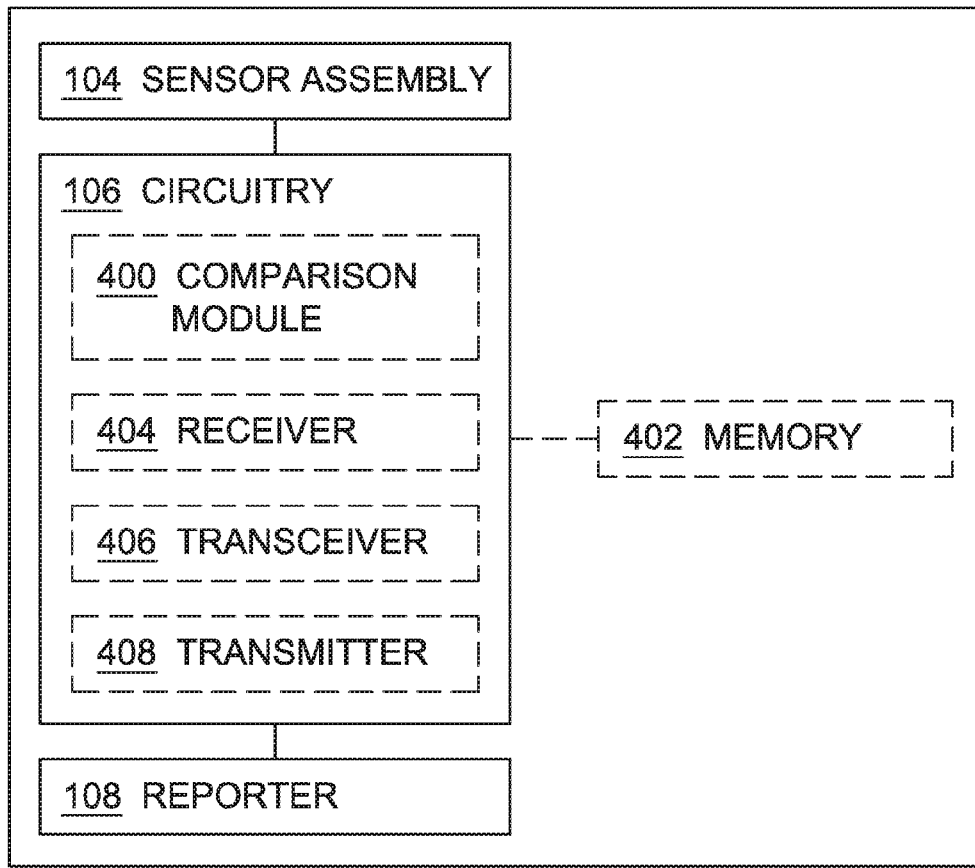

FIG. 4

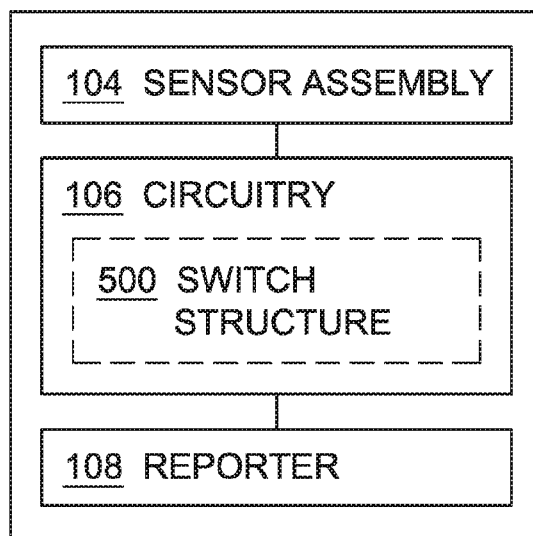

FIG. 5

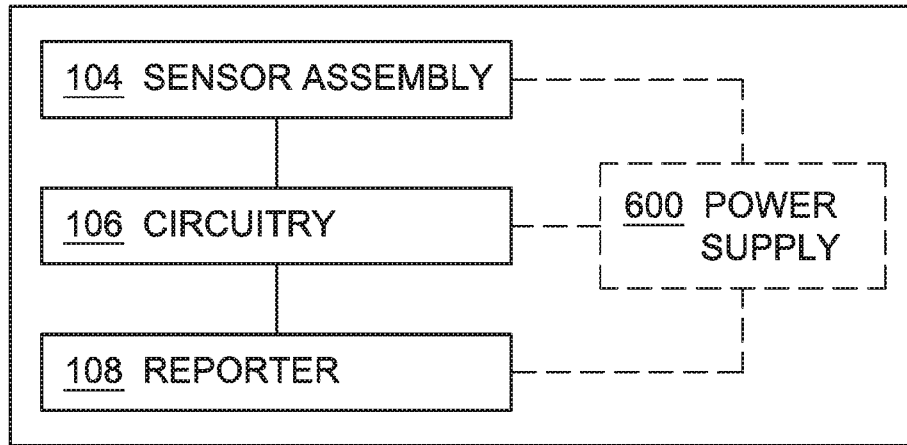

FIG. 6

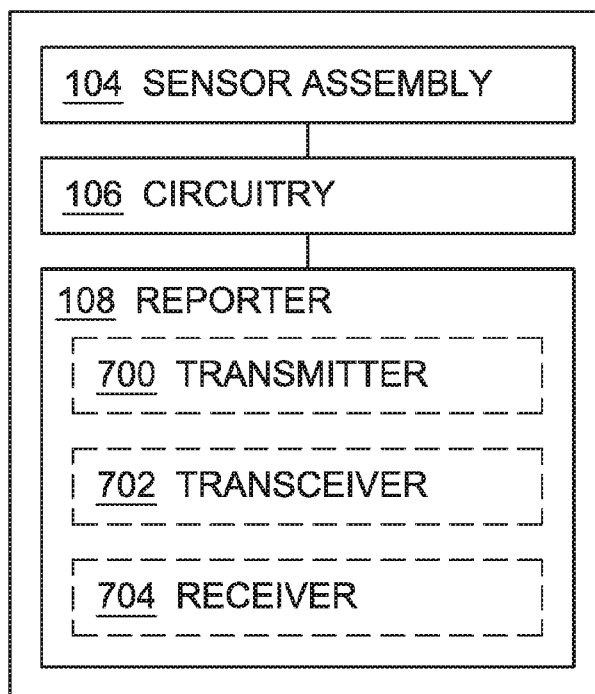

FIG. 7

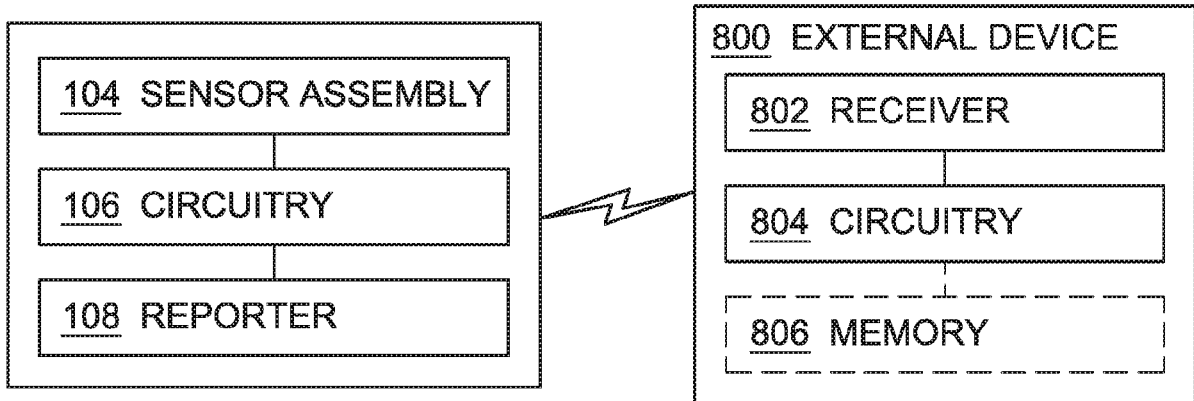

FIG. 8

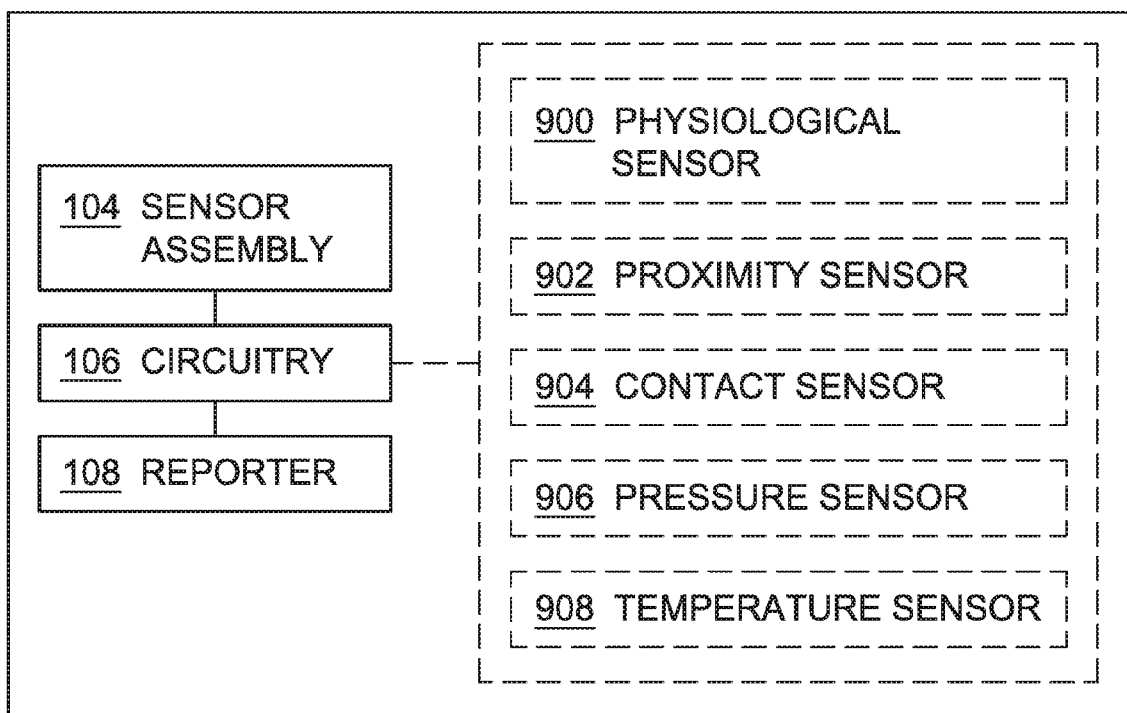

FIG. 9

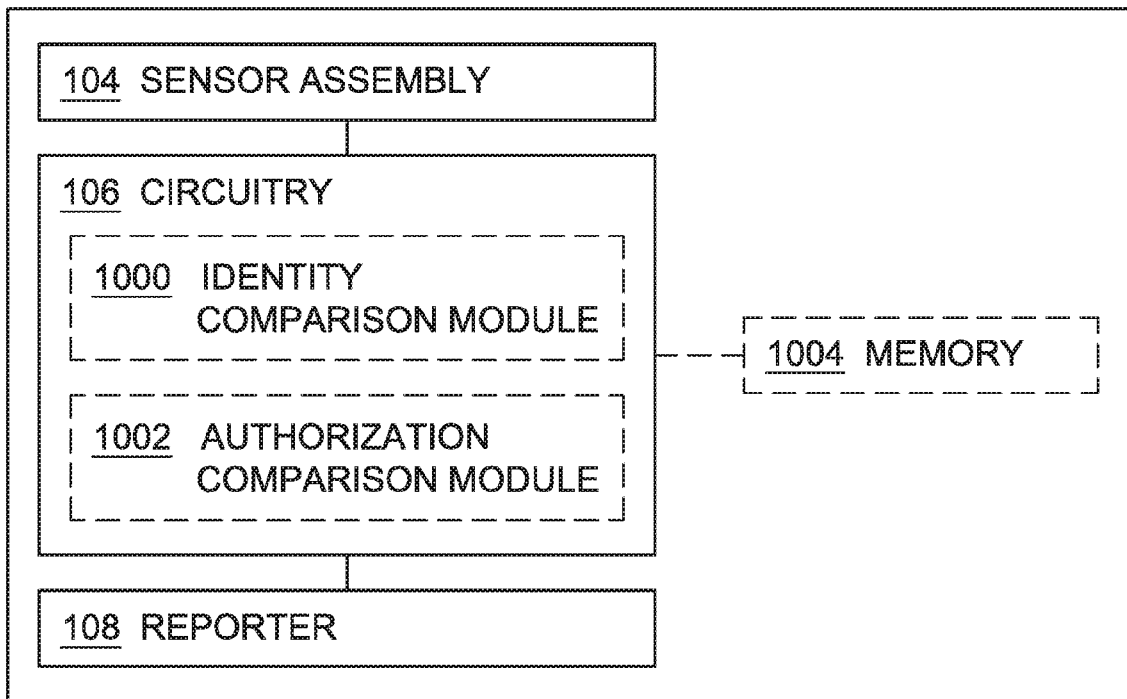

FIG. 10

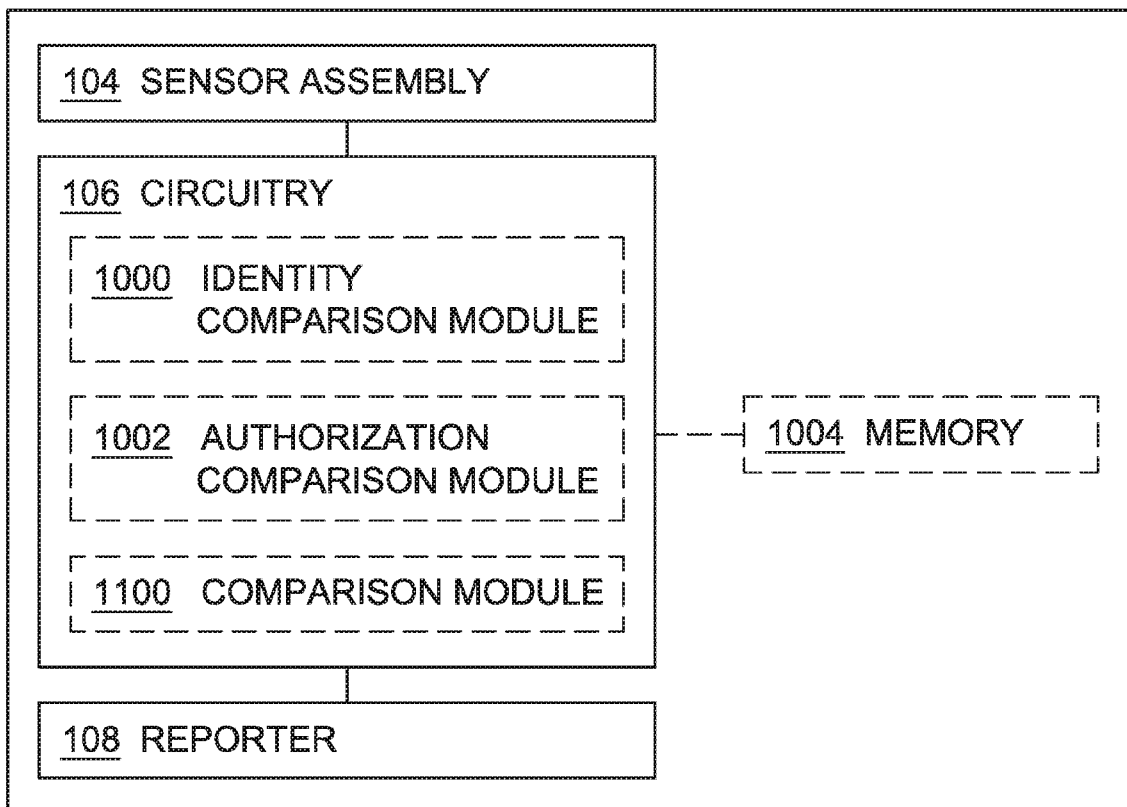

FIG. 11

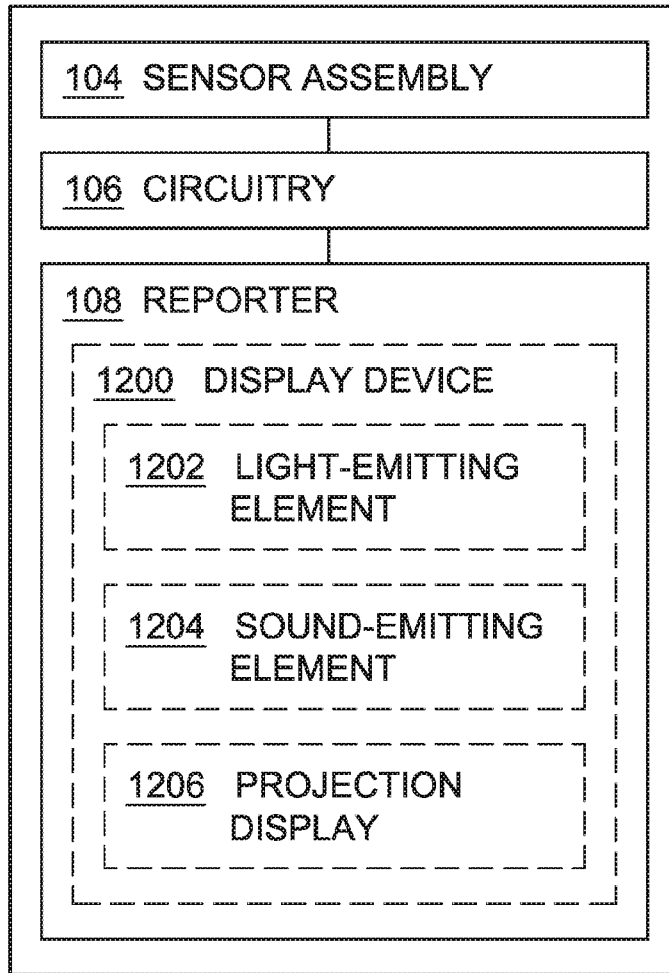

FIG. 12

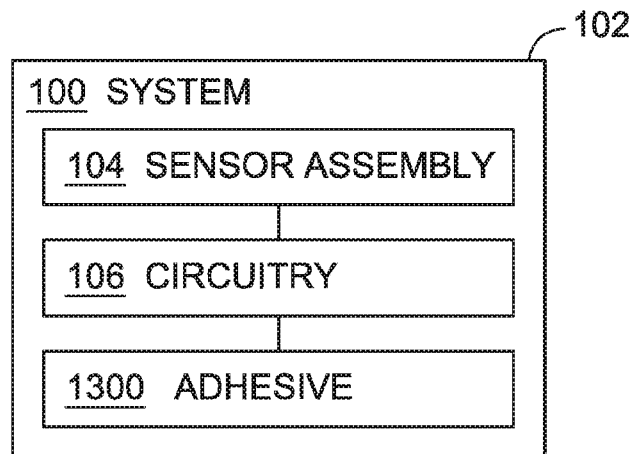

FIG. 13

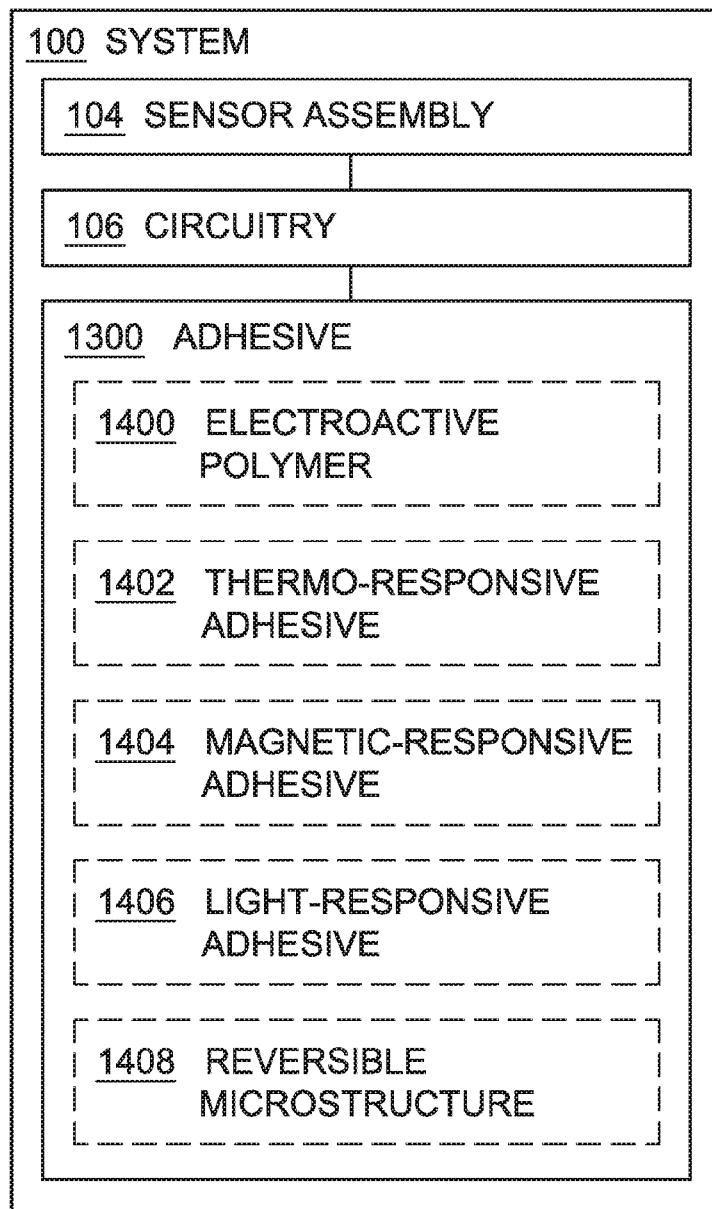

FIG. 14

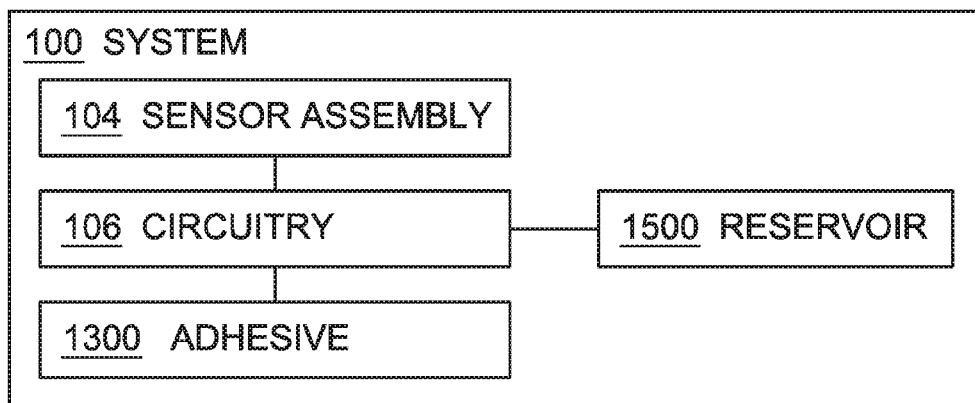
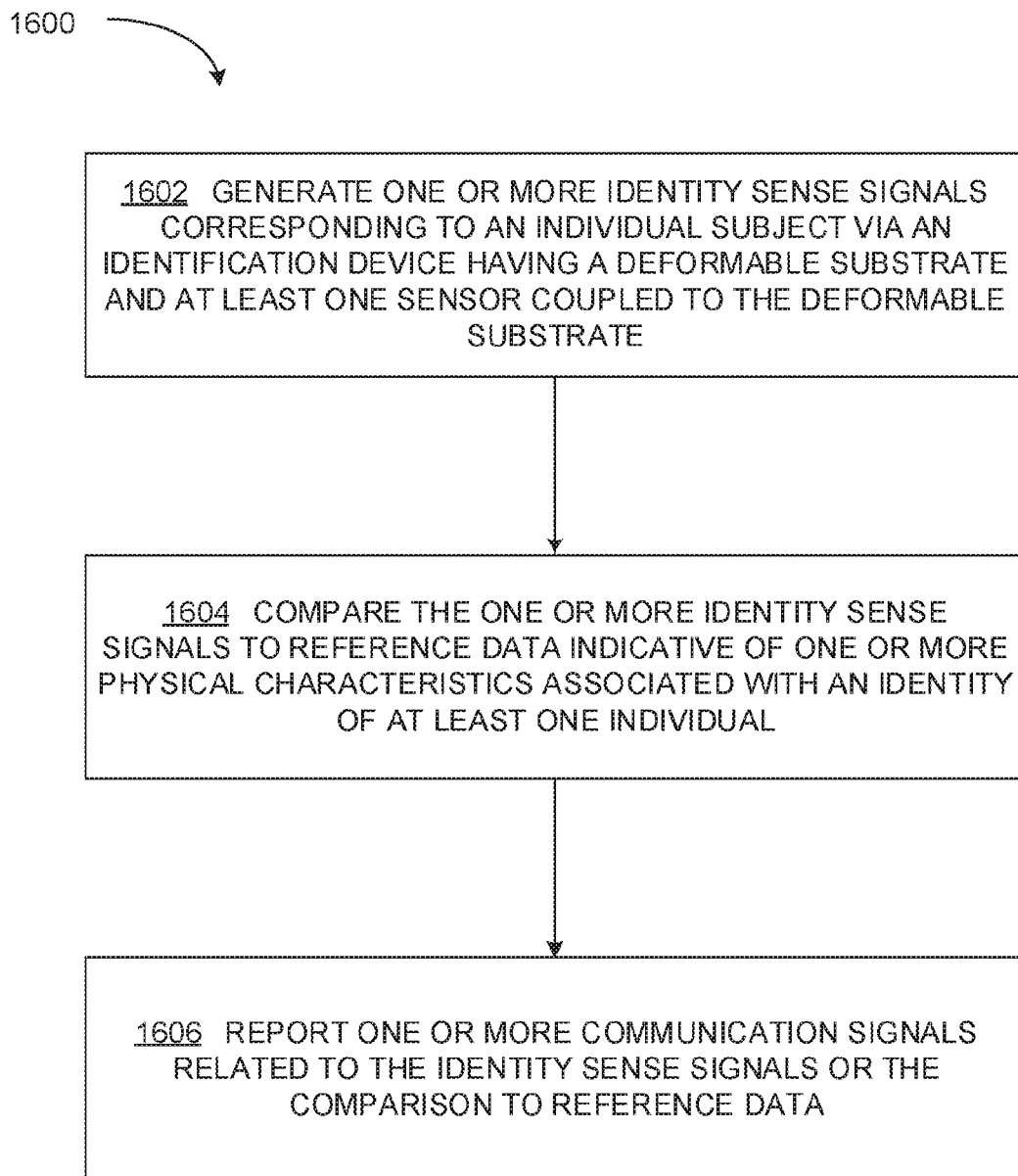
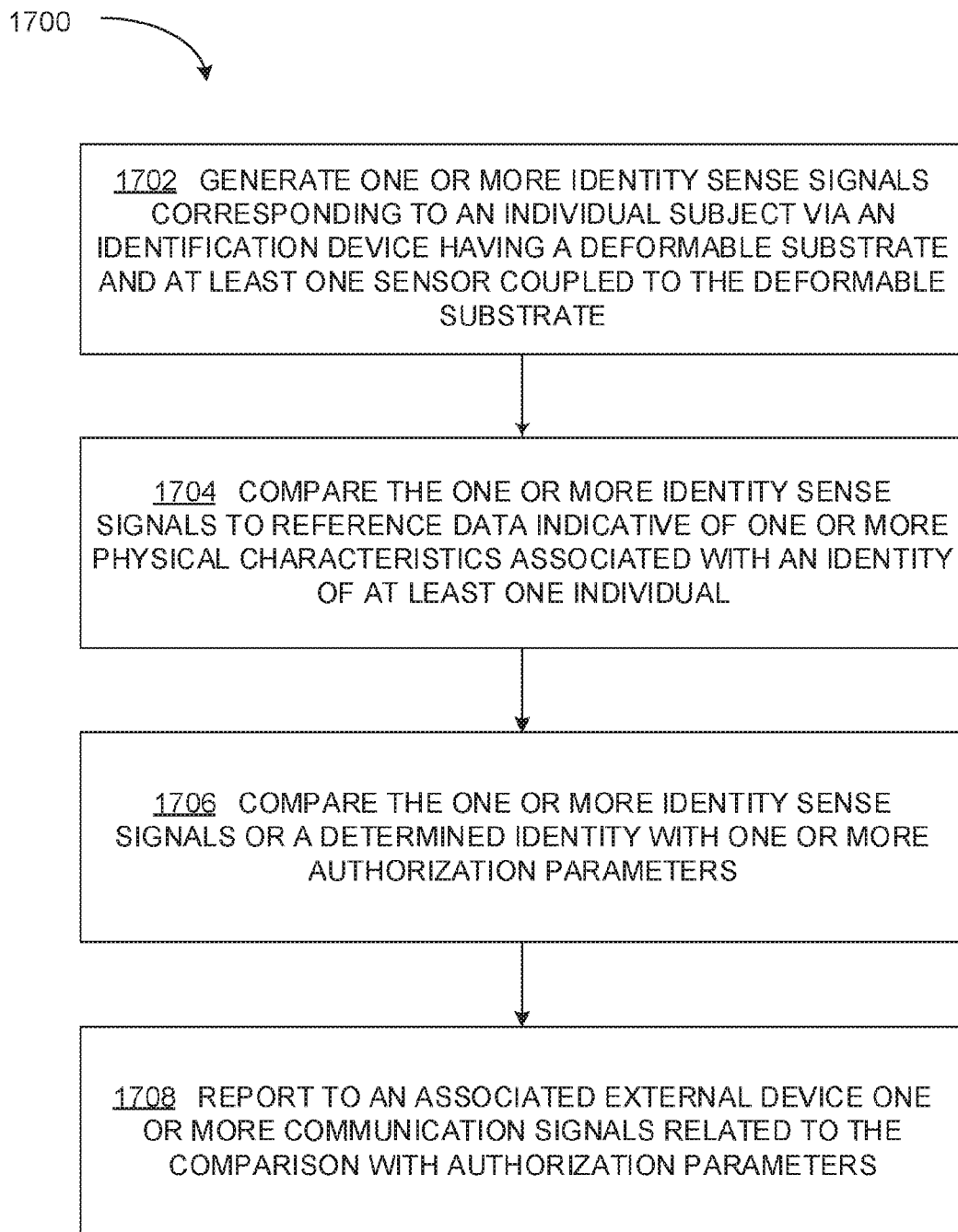
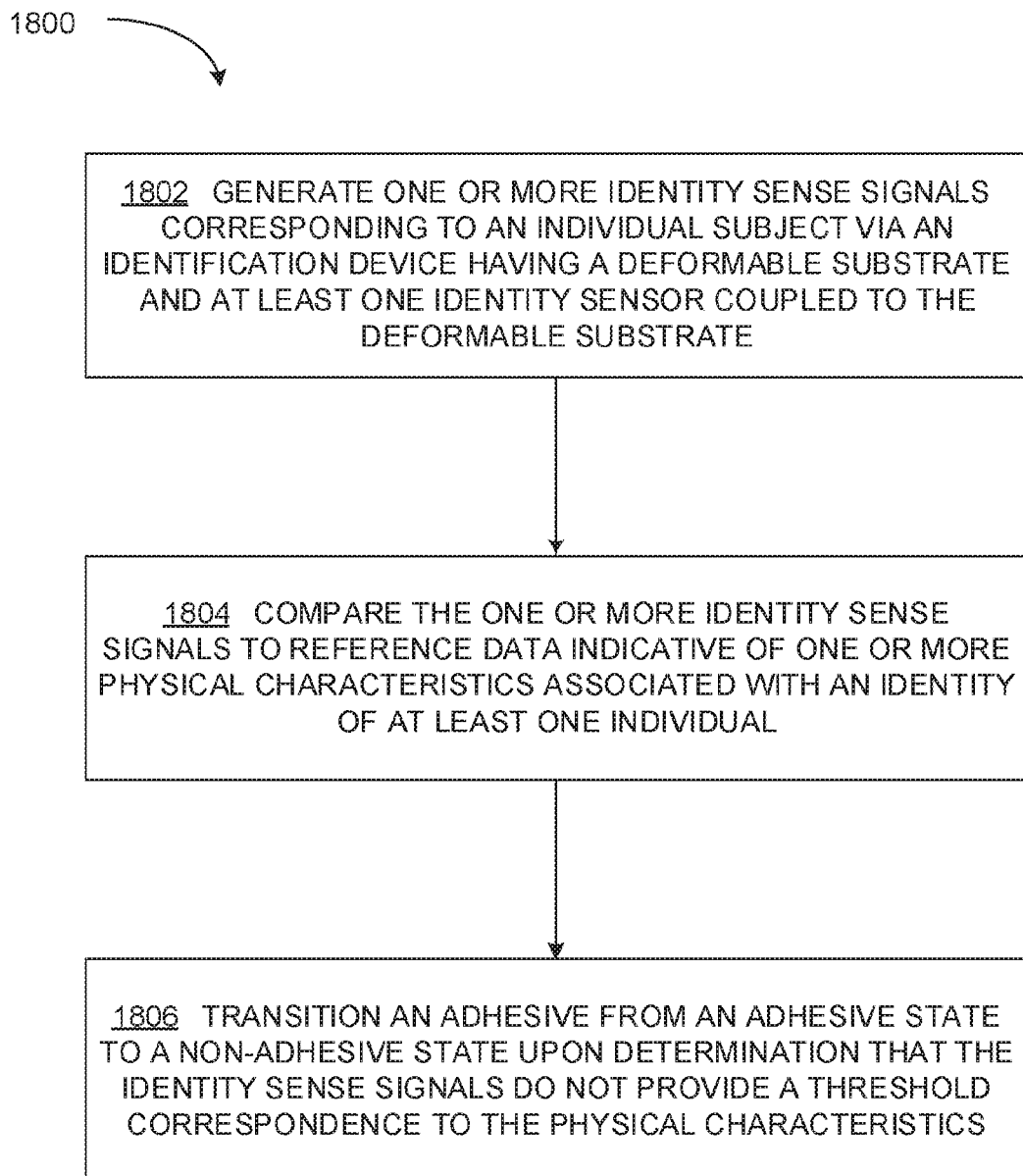
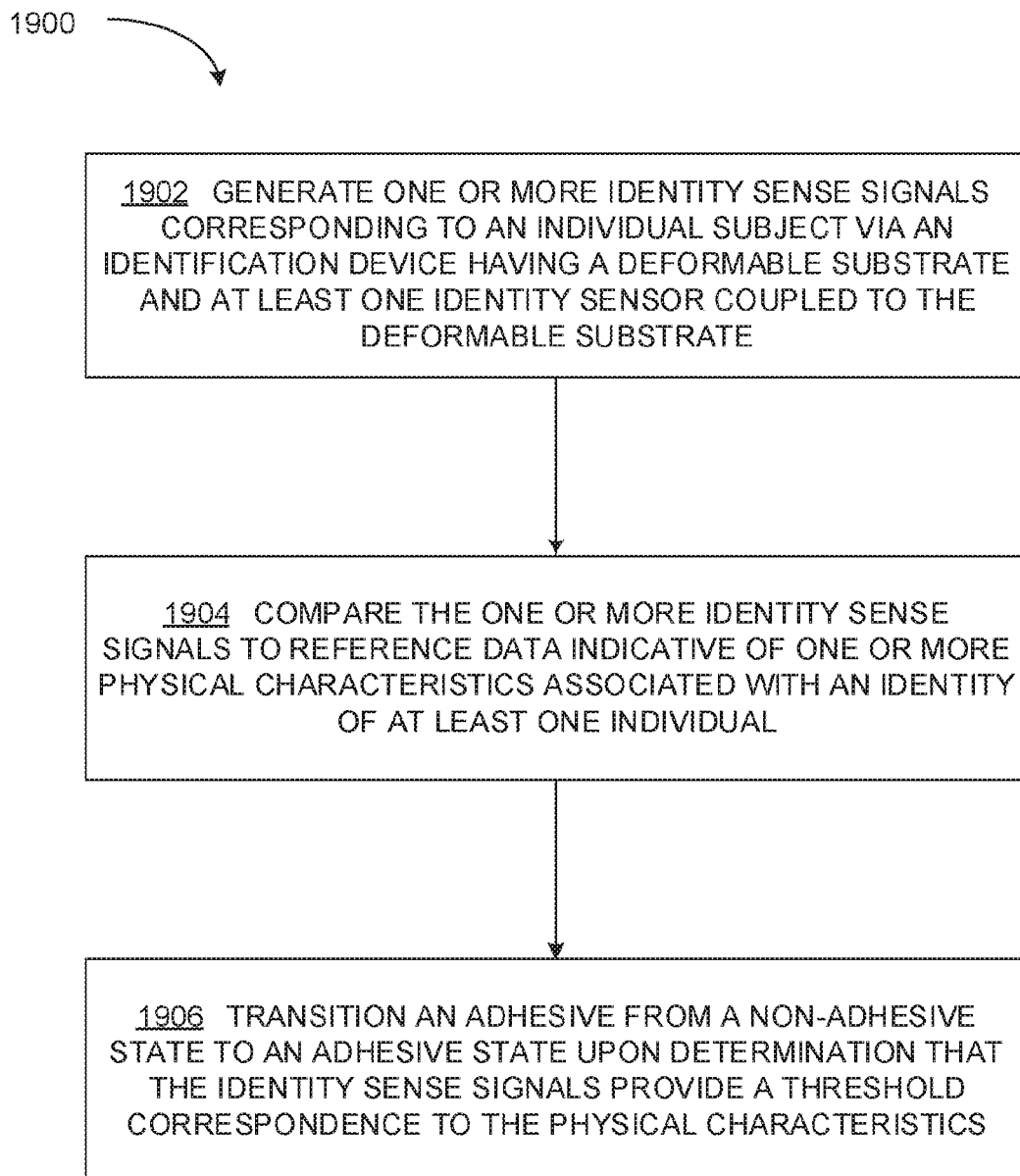

FIG. 15

**FIG. 16**

**FIG. 17**

**FIG. 18**

**FIG. 19**

INTERNATIONAL SEARCH REPORT

International application No.
PCT/US2017/046106**A. CLASSIFICATION OF SUBJECT MATTER****A61B 5/117(2006.01)i, A61B 5/00(2006.01)i**

According to International Patent Classification (IPC) or to both national classification and IPC

B. FIELDS SEARCHED

Minimum documentation searched (classification system followed by classification symbols)

A61B 5/117; A61B 5/04; A61B 5/021; A61B 5/053; H04L 9/32; A61B 5/0456; G01B 7/02; A61B 5/00; G06F 7/04

Documentation searched other than minimum documentation to the extent that such documents are included in the fields searched

Korean utility models and applications for utility models
Japanese utility models and applications for utility models

Electronic data base consulted during the international search (name of data base and, where practicable, search terms used)

eKOMPASS(KIPO internal) & Keywords: identify, individual, physiologic, sensor, patch, adhere

C. DOCUMENTS CONSIDERED TO BE RELEVANT

Category*	Citation of document, with indication, where appropriate, of the relevant passages	Relevant to claim No.
X	US 2016-0051156 A1 (SEOUL NATIONAL UNIVERSITY R&DB FOUNDATION) 25 February 2016 See paragraphs [12],[81],[88],[115],[122],[178]-[180],[191] and figures 6,11, 24.	21,25-27,31-32,36 ,42
Y		22-24,28-30,33-35 ,37-41,43-47
A		1-20
Y	US 2013-0041235 A1 (ROGERS et al.) 14 February 2013 See claims 1,23,25,30-34.	22-24,33-35,37-38
Y	US 2015-0292856 A1 (QUALCOMM INCORPORATED) 15 October 2015 See paragraphs [43],[44], claim 1 and figures 3A-3D.	28-30,39-41,47
Y	JP 2006-346221 A (HEART METRICS K.K. et al.) 28 December 2006 See paragraphs [21]-[32],[41] and figures 1-3.	43-47
A	US 2012-0029312 A1 (BEAUDRY et al.) 02 February 2012 See claims 7-21 and figures 1-3B.	1-47

 Further documents are listed in the continuation of Box C. See patent family annex.

* Special categories of cited documents:

"A" document defining the general state of the art which is not considered to be of particular relevance

"E" earlier application or patent but published on or after the international filing date

"L" document which may throw doubts on priority claim(s) or which is cited to establish the publication date of another citation or other special reason (as specified)

"O" document referring to an oral disclosure, use, exhibition or other means

"P" document published prior to the international filing date but later than the priority date claimed

"T" later document published after the international filing date or priority date and not in conflict with the application but cited to understand the principle or theory underlying the invention

"X" document of particular relevance; the claimed invention cannot be considered novel or cannot be considered to involve an inventive step when the document is taken alone

"Y" document of particular relevance; the claimed invention cannot be considered to involve an inventive step when the document is combined with one or more other such documents, such combination being obvious to a person skilled in the art

"&" document member of the same patent family

Date of the actual completion of the international search

17 November 2017 (17.11.2017)

Date of mailing of the international search report

17 November 2017 (17.11.2017)

Name and mailing address of the ISA/KR

International Application Division
Korean Intellectual Property Office
189 Cheongsa-ro, Seo-gu, Daejeon, 35208, Republic of Korea

Facsimile No. +82-42-481-8578

Authorized officer

KIM, Sung Gon

Telephone No. +82-42-481-8746

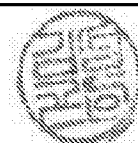

INTERNATIONAL SEARCH REPORT

Information on patent family members

International application No.

PCT/US2017/046106

Patent document cited in search report	Publication date	Patent family member(s)	Publication date
US 2016-0051156 A1	25/02/2016	KR 10-1489503 B1	04/02/2015
		KR 10-1524248 B1	29/05/2015
		KR 10-1576665 B1	21/12/2015
		KR 10-1593684 B1	12/02/2016
		WO 2014-157896 A1	02/10/2014
US 2013-0041235 A1	14/02/2013	CN 102892356 A	23/01/2013
		CN 102892356 B	13/01/2016
		CN 104224171 A	24/12/2014
		CN 104224171 B	09/06/2017
		CN 105496423 A	20/04/2016
		EP 2513953 A1	24/10/2012
		EP 2544598 A1	16/01/2013
		EP 2547258 A1	23/01/2013
		EP 2547258 B1	05/08/2015
		EP 2974673 A1	20/01/2016
		EP 2974673 B1	22/03/2017
		JP 2013-514146 A	25/04/2013
		JP 2013-524866 A	20/06/2013
		JP 2015-164564 A	17/09/2015
		JP 2017-080421 A	18/05/2017
		JP 5751728 B2	22/07/2015
		JP 6046491 B2	21/12/2016
		KR 10-1724273 B1	07/04/2017
		KR 10-2017-0033906 A	27/03/2017
		TW 201129342 A	01/09/2011
		TW 201639525 A	16/11/2016
		TW I535417 B	01/06/2016
		TW I556802 B	11/11/2016
		US 2011-0230747 A1	22/09/2011
		US 2012-0157804 A1	21/06/2012
		US 2012-0165759 A1	28/06/2012
		US 2014-0163390 A1	12/06/2014
US 8666471 B2	04/03/2014		
WO 2011-084450 A1	14/07/2011		
WO 2011-112931 A1	15/09/2011		
WO 2011-115643 A1	22/09/2011		
US 2015-0292856 A1	15/10/2015	CN 106163382 A	23/11/2016
		EP 3128903 A2	15/02/2017
		JP 2017-512600 A	25/05/2017
		KR 10-2016-0141801 A	09/12/2016
		US 9459089 B2	04/10/2016
		WO 2015-157445 A2	15/10/2015
WO 2015-157445 A3	03/12/2015		
JP 2006-346221 A	28/12/2006	None	
US 2012-0029312 A1	02/02/2012	WO 2012-015768 A2	02/02/2012

INTERNATIONAL SEARCH REPORT

Information on patent family members

International application No.

PCT/US2017/046106

Patent document cited in search report	Publication date	Patent family member(s)	Publication date
		WO 2012-015768 A3	31/05/2012

专利名称(译)	使用自适应电子进行个人识别和授权的系统和方法		
公开(公告)号	EP3496609A4	公开(公告)日	2020-04-01
申请号	EP2017840213	申请日	2017-08-09
[标]申请(专利权)人(译)	埃尔瓦有限公司		
申请(专利权)人(译)	ELWHA LLC		
当前申请(专利权)人(译)	ELWHA LLC		
[标]发明人	HYDE RODERICK A MCKNIGHT GARY L PETROSKI ROBERT C SWEENEY ELIZABETH A		
发明人	HYDE, RODERICK A. MCKNIGHT, GARY L. PETROSKI, ROBERT C. SWEENEY, ELIZABETH A.		
IPC分类号	A61B5/117 A61B5/00		
CPC分类号	A61B5/117 A61B5/6832 G06F21/32 G07C9/37		
代理机构(译)	øYOUNG & CO LLP		
优先权	15/232884 2016-08-10 US 15/232888 2016-08-10 US 15/232894 2016-08-10 US		
其他公开文献	EP3496609A1		
外部链接	Espacenet		

摘要(译)

装置实施例包括但不限于可变形基板；一种传感器组件，包括一个或多个传感器，所述一个或多个传感器被配置为产生与一个个体受试者的至少一个身体特征相关联的一个或多个身份感测信号；该电路包括身份比较模块，该身份比较模块被配置为将一个或多个身份感测信号与指示与至少一个个体的身份相关联的一个或多个物理特性的参考数据进行比较，以确定该一个或多个身份感测信号是否对应于以下身份：至少一个人，该电路包括授权比较模块，该授权比较模块被配置为将身份感测信号或身份中的至少一个与一个或多个授权参数进行比较；报告器，其配置为产生与所述一个或多个身份感测信号中的至少一个相关联的一个或多个通信信号，或者生成所述一个或多个身份感测信号中的至少一个与与所述身份相关联的一个或多个物理特性的比较至少一个个体或授权参数或具有一个或多个授权参数的身份。