



(11) **EP 1 860 989 B1**

(12) **EUROPEAN PATENT SPECIFICATION**

(45) Date of publication and mention of the grant of the patent:
21.11.2018 Bulletin 2018/47

(21) Application number: **06736668.2**

(22) Date of filing: **01.03.2006**

(51) Int Cl.:
A61B 5/00 (2006.01)

(86) International application number:
PCT/US2006/007387

(87) International publication number:
WO 2006/094107 (08.09.2006 Gazette 2006/36)

(54) **PHYSIOLOGICAL PARAMETER CONFIDENCE MEASURE**

MASS FÜR DIE ZUVERLÄSSIGKEIT EINES PHYSIOLOGISCHEN PARAMETERS

MESURE DE CONFIANCE D'UN PARAMÈTRE PHYSIOLOGIQUE

(84) Designated Contracting States:
AT BE BG CH CY CZ DE DK EE ES FI FR GB GR HU IE IS IT LI LT LU LV MC NL PL PT RO SE SI SK TR

(30) Priority: **01.03.2005 US 657596 P**
01.03.2005 US 657759 P
01.03.2005 US 657268 P
01.03.2005 US 657281 P

(43) Date of publication of application:
05.12.2007 Bulletin 2007/49

(60) Divisional application:
10191029.7 / 2 286 721

(73) Proprietor: **Masimo Laboratories, Inc.**
Irvine, CA 92618 (US)

(72) Inventors:
• **DIAB, Mohamed**
Mission Viejo, CA 92692 (US)
• **LAMEGO, Marcelo**
Rancho Santa Margarita, CA 92688 (BR)
• **AL-ALI, Ammar**
Tustin, CA 92782 (US)

(74) Representative: **Vossius & Partner**
Patentanwälte Rechtsanwälte mbB
Siebertstrasse 3
81675 München (DE)

(56) References cited:
WO-A-98/43071 US-A- 4 653 498
US-A1- 2004 133 087 US-A1- 2004 158 134

EP 1 860 989 B1

Note: Within nine months of the publication of the mention of the grant of the European patent in the European Patent Bulletin, any person may give notice to the European Patent Office of opposition to that patent, in accordance with the Implementing Regulations. Notice of opposition shall not be deemed to have been filed until the opposition fee has been paid. (Art. 99(1) European Patent Convention).

Description

[0001] Spectroscopy is a common technique for measuring the concentration of organic and some inorganic constituents of a solution. The theoretical basis of this technique is the Beer-Lambert law, which states that the concentration c_i of an absorbent in solution can be determined by the intensity of light transmitted through the solution, knowing the pathlength d_λ , the intensity of the incident light $I_{0,\lambda}$, and the extinction coefficient $\epsilon_{i,\lambda}$ at a particular wavelength λ . In generalized form, the Beer-Lambert law is expressed as:

$$I_\lambda = I_{0,\lambda} e^{-d_\lambda \cdot \mu_{a,\lambda}} \quad (1)$$

$$\mu_{a,\lambda} = \sum_{i=1}^n \epsilon_{i,\lambda} \cdot c_i \quad (2)$$

where $\mu_{a,\lambda}$ is the bulk absorption coefficient and represents the probability of absorption per unit length. The minimum number of discrete wavelengths that are required to solve EQS. 1-2 are the number of significant absorbers that are present in the solution.

[0002] A practical application of this technique is pulse oximetry, which utilizes a noninvasive sensor to measure oxygen saturation (SpO₂) and pulse rate. In general, the sensor has light emitting diodes (LEDs) that transmit optical radiation of red and infrared wavelengths into a tissue site and a detector that responds to the intensity of the optical radiation after absorption (e.g., by transmission or transreflectance) by pulsatile arterial blood flowing within the tissue site. Based on this response, a processor determines measurements for SpO₂, pulse rate, and can output representative plethysmographic waveforms. Thus, "pulse oximetry" as used herein encompasses its broad ordinary meaning known to one of skill in the art, which includes at least those noninvasive procedures for measuring parameters of circulating blood through spectroscopy. Moreover, "plethysmograph" as used herein (commonly referred to as "photoplethysmograph"), encompasses its broad ordinary meaning known to one of skill in the art, which includes at least data representative of a change in the absorption of particular wavelengths of light as a function of the changes in body tissue resulting from pulsing blood.

[0003] Pulse oximeters capable of reading through motion induced noise are available from Masimo Corporation ("Masimo") of Irvine, California. Moreover, portable and other oximeters capable of reading through motion induced noise are disclosed in at least U.S. Pat. Nos. 6,770,028, 6,658,276, 6,157,850, 6,002,952, 5,769,785, and 5,758,644.

US 4,653,498 describes a pulse oximetry system that includes a systematic rejection of extraneous or irregular detected data that prevents the undue sounding of alarms.

Such reading through motion oximeters have gained rapid acceptance in a wide variety of medical applications, including surgical wards, intensive care and neonatal units, general wards, home care, physical training, and virtually all types of monitoring scenarios.

[0004] FIG. 1 illustrates HbO₂ and Hb absorption μ_a versus wavelength. At red and near IR wavelengths below 970 nm, where water has a significant peak, Hb and HbO₂ are the only significant absorbers normally present in the blood. Thus, typically only two wavelengths are needed to resolve the concentrations of Hb and HbO₂, e.g. a red (RD) wavelength at 660 nm and an infrared (IR) wavelength at 940 nm. In particular, SpO₂ is computed based upon a red ratio Red_{AD}/Red_{DC} and an IR ratio IR_{AC}/IR_{DC}, which are the AC detector response magnitude at a particular wavelength normalized by the DC detector response at that wavelength. The normalization by the DC detector response reduces measurement sensitivity to variations in tissue thickness, emitter intensity and detector sensitivity, for example. The AC detector response is a plethysmograph, as described above. Thus, the red and IR ratios can be denoted as NP_{RD} and NP_{IR} respectively, where NP stands for "normalized plethysmograph." In pulse oximetry, oxygen saturation is calculated from the ratio NP_{RD}/NP_{IR}.

[0005] A multiple wavelength sensor and a noninvasive multi-parameter patient monitor, such as referenced above, make blood absorption measurements at more than a red wavelength and an IR wavelength.

The present invention relates to a method of determining a measure of confidence in a physiological parameter according to claim 1 and to a confidence measurement system according to claim 7. In one embodiment, described below, blood absorption measurements are made at eight wavelengths. Advantageously, this rich wavelength data, compared with conventional pulse oximetry, allows a determination of a tissue profile or tissue characterization over a wavelength spectrum.

[0006] FIG. 2 illustrates an example of a "tissue profile" **200** for SpO₂ = 97%. For this example, including FIGS. 3-4, below, the sensor emits eight wavelengths (610, 620, 630, 655, 700, 720, 800 and 905 nm). The graph is a plot of NP ratios **210** versus wavelength **220**, where the NP ratios are of the form NP_{λ1}/NP_{λ2}. This is a generalization to multiple wavelengths of the ratio NP_{RD}/NP_{IR} described above for two (red and IR) wavelengths. In order to provide a common scale for these NP ratios, the ratios are calculated with respect to a reference wavelength, λ_r, which may be any of the available wavelengths. Thus, the plotted NP ratios are denoted NP_{λn}/NP_{λr} over the n available wavelengths, including λ_r. Note that the NP ratio at the reference wavelength is NP_{λr}/NP_{λr} = 1, which is 800 nm in FIG. 2.

[0007] As shown in FIG. 2, when a sensor is properly

positioned on a tissue site, the detector only receives LED emitted light that has propagated through the tissue site after tissue scattering and absorption. Thus, a tissue profile **200** should reflect the blood constituent absorption characteristics illustrated in FIG. 1, above. For this high oxygen saturation (97%) example, HbO₂ is the only significantly absorbing blood constituent and, indeed, the resulting tissue profile **200** is shaped like the HbO₂ absorption curve **110** (FIG. 1).

FIG. 1 is a graph of oxyhemoglobin and reduced hemoglobin light absorption versus wavelength across portions of the red and IR spectrum;

FIG. 2 is a graph of NP ratios versus wavelength illustrating a tissue profile;

FIG. 3 is a graph of NP ratios versus wavelength illustrating a probe-off profile;

FIG. 4 is a graph of NP ratios versus wavelength illustrating a penumbra profile;

FIG. 5 is a general block diagram of a confidence measurement system;

FIG. 6 is a graph of normalized plethysmograph (NP) ratios versus wavelength for low and high SpO₂ illustrating a NP envelope;

FIG. 7 is a block diagram of a multiple wavelength probe off detector utilizing an NP envelope;

FIG. 8 is a graph of NP ratios versus wavelength illustrating a family of parametric NP curves;

FIG. 9 is a block diagram of a multiple wavelength confidence measurement system utilizing parametric NP curves;

FIG. 10 is an NP ratio graph illustrating a family of NP data clusters; and

FIG. 11 is a block diagram of a multiple wavelength confidence measurement system utilizing NP data clusters.

[0008] In this application, reference is made to many blood parameters. Some references that have common shorthand designations are referenced through such shorthand designations. For example, as used herein, HbCO designates carboxyhemoglobin, HbMet designates methemoglobin, and Hbt designates total hemoglobin. Other shorthand designations such as COHb, MetHb, and tHb are also common in the art for these same constituents. These constituents are generally reported in terms of a percentage, often referred to as saturation, relative concentration or fractional saturation. Total hemoglobin is generally reported as a concentration in g/dL. The use of the particular shorthand designators presented in this application does not restrict the term to any particular manner in which the designated constituent is reported.

[0009] FIG. 3 illustrates an example of a probe-off profile **300**. When a sensor is completely dislodged from a patient, a so-called "probe off" condition occurs. Despite a probe off condition, an optical sensor may continue to detect an AC signal, which can be induced at the detector

by other than pulsatile arterial absorption of LED emitted light. For example, small patient movements, vibrations, air flow or other perturbations may cause the pathlength between the LEDs and the detector to vary, resulting in an AC detector signal that can be mistakenly interpreted by the monitor as due to pulsatile arterial blood. Further, ambient light may reach the detector, and any modulation of the ambient light due to AC power, power fluctuations, moving objects, such as a fan, among other perturbations can be also mistaken as a pulsatile arterial signal. Probe off errors are serious because a blood constituent monitor may display normal results, such as oxygen saturation, when, in fact, the sensor is not properly attached to the patient, potentially leading to missed severe desaturation events. As shown in FIG. 3, a probe-off profile **300** is readily apparent as it does not have a shape related to the absorption characteristics of hemoglobin constituents.

[0010] FIG. 4 illustrates an example of a penumbra profile **400**. When a sensor is not properly positioned or becomes partially dislodged, a penumbra condition may occur, where the detector is "shadowed" by a tissue site, such as a finger, but also receives some light directly from the emitters or indirectly reflected off the sensor housing, or both. As a result, the DC signal at the detector rises significantly, which lowers the AC/DC ratio (NP). Because red wavelengths are more significantly absorbed by Hb and HbO₂, the penumbra condition is most noticeable at the red portion **405** of the NP_{λ_n} / NP_{λ_r}. This effect is readily seen in the penumbra profile **400** as compared to a normal tissue profile **200** (FIG. 2).

[0011] Advantageously, a physiological parameter confidence measurement system, as described below, can distinguish a tissue profile **200** (FIG. 2) from a probe-off profile **300** (FIG. 3) or penumbra profile **400** (FIG. 4), as examples. Further, a physiological parameter confidence measurement system can provide indications that the detector signal is degraded as the result of various physiological and non-physiological phenomenon.

[0012] FIG. 5 illustrates a physiological parameter confidence measurement system **500** having a physiological data **510** input, a confidence indicator **560** output and a probe-off indicator **570** output. In one embodiment, physiological data **510**, such as the NP ratios described above, is derived from a sensor **501** generating a sensor signal **502** responsive to multiple wavelengths of optical radiation transmitted into and attenuated by a tissue site. The confidence indicator **560** provides an observer with some measure of "goodness" for the physiological data **510**. That is, if confidence is high, it is likely the physiological data **510** is representative of a physiological condition or state. If confidence is low, the physiological data **510** may be less representative of a physiological condition or state. If the confidence is very low, a probe-off indicator **570** may be generated to alert an observer to the possibility that a sensor from which the physiological data **510** is derived is not properly positioned on a tissue site and may not be generating physiologically significant

data. In one embodiment, a confidence measure may be provided as a percentage, such as 0-100%. In various embodiments, a confidence indicator **560** corresponding to a confidence measure may be visual or audible or both. For example, a confidence indicator **560** may be a number display, a display message, a bar display, a color indicator or display, such as green (high confidence), yellow (average confidence), red (low confidence). Also, a confidence indicator **560** may be any of various alarm sounds, tones or patterns of sounds or tones, such as a double beep at less than high confidence. In one embodiment, the physiological parameter confidence measurement system **500** is incorporated within a physiological monitor **503** having a display **580** or alarm **590** for outputting the confidence indicator **560** or probe-off indicator **570**.

[0013] As shown in FIG. 5, the physiological parameter confidence measurement system **500** also has a parameter estimator **520**, a physiological data reference **540** and a confidence measurer **550**. The parameter estimator **520** derives one or more physiological parameter estimates, \hat{P} , **530** based upon the physiological data **510**. The parameter estimate or estimates **530** are used to select one or more data clusters **545** from the physiological data reference **540**. In one embodiment, the physiological data reference **540** is a collection of predetermined physiological data organized in data clusters. For example the physiological data reference **540** may contain clinically-derived physiological data organized according to corresponding values of a physiological parameter determined by a "gold standard" instrument. In a particular embodiment, the physiological data are NP ratios obtained for various physiological parameters, such as SpO₂, HbCO, HbMet, Hbt, fractional oxygen saturation, bilirubin or glucose to name a few, as measured with a standardized cooximeter, for example. In one embodiment, the physiological data reference **540** is a non-volatile memory or other data storage device containing predetermined physiological data. The confidence measurer **550** uses the physiological data **510** and the selected data cluster or data clusters **545** to generate the confidence indicator **560**, the probe-off indicator **570** or both.

[0014] A confidence measurement and confidence indicator, as described herein, may be combined with other signal quality and data confidence measurements and indicators, such as those described in U.S. Patent No. 6,996,427 titled *Pulse Oximetry Data Confidence Indicator* and U.S. Patent No. 6,606,511 titled *Pulse Oximetry Pulse Indicator*, both patents assigned to Masimo Corporation, Irvine, CA. A probe off measurement and probe off indicator as described herein may be combined with other probe off measurements and indicators, such as those described in U.S. Patent No. 6,654,624 titled *Pulse Oximeter Probe-Off Detector* and U.S. Patent No. 6,771,994 titled *Pulse Oximeter Probe-Off Detection System*, both patents assigned to Masimo Corporation, Irvine, CA.

[0015] FIG. 6 illustrates NP ratio versus wavelength

curves computed from a multiple wavelength sensor, such as described in the U.S. Patent Application titled *Multiple Wavelength Sensor*, referenced above. In this example, the sensor emits eight wavelengths (620, 630, 660, 700, 730, 805, 905 and 960nm). Shown is a low oxygen saturation curve **610**, e.g. = 70% and a high oxygen saturation curve **620**, e.g. SpO₂ ≈ 100%. By comparison, a conventional two wavelength pulse oximetry sensor, as described above, results in a single point on a particular curve. Advantageously, the NP ratio curves **610**, **620** represent a tissue profile that can be compared to a particular sensor response to determine if a physiologically significant measurement has been made. In one embodiment, the NP ratio curves **610**, **620** delineate the boundaries of a physiologically significant NP ratio region **630**. Although described above with respect to SpO₂, such regions or boundaries can be derived for other physiological parameters such as HbCO, HbMet, Hbt, fractional oxygen saturation, bilirubin or glucose to name a few.

[0016] FIG. 7 illustrates one embodiment of a physiological parameter confidence measurement system **700** utilizing a NP ratio region such as described with respect to FIG. 6, above. The confidence measurement system **700** has input NP ratios **710** measured in response to a multiple wavelength sensor, reference NP ratio region **740** that delineates physiologically significant NP ratios **630** (FIG. 6), and a comparator **750**. In one particular embodiment, the NP ratio region **740** is predetermined from clinically-derived data for one or more parameters of interest, such as SpO₂, HbCO, HbMet, Hbt, fractional oxygen saturation, bilirubin or glucose, to name a few. In another particular embodiment, the NP ratio region **740** is theoretically calculated. The comparator **750** compares the input NP ratios **710** with the NP ratio region **740** and generates a probe-off indicator **770** if any, or more than a predetermined number, of the input NP ratios **710** fall outside of an NP ratio region **740**.

[0017] FIG. 8 illustrates a family of parametric NP ratio versus wavelength curves **800** computed from a multiple wavelength sensor, such as referenced above. Each curve represents a different value of a measured parameter, such as SpO₂. For example, there may be a curve for each of = 70%, 75%, 80%,... 100%. Advantageously, such curves more precisely indicate physiologically significant multiple wavelength sensor measurements as compared to a bounded NP ratio region **630** (FIG. 6) such as described with respect to FIGS. 6-7, above.

[0018] FIG. 9 illustrates another embodiment of a physiological parameter confidence measurement system **900** utilizing parametric NP ratio curves, such as described with respect to FIG. 8, above. The confidence measurement system **900** has input NP ratios **910** measured in response to a multiple wavelength sensor, a parameter estimator **920**, reference parametric curves **940** and a difference calculator **950**. The parameter estimator **920** inputs the NP ratios **910** so as to generate a parameter estimate **930**, such as SpO₂, HbCO, HbMet, Hbt,

fractional oxygen saturation, bilirubin or glucose, to name a few. The estimated parameter **930** selects one or more of the reference parametric curves **940**, which are predetermined from clinically-derived data that is stored in memory or data that is mathematically pre-calculated or calculated in real time and stored in memory. The difference calculator **950** measures the difference between the NP ratios **910** and the selected parametric curve **940**. For example, a mean-squared error calculation can be made between the input NP ratios **910** and the selected parametric curve **945**. The resulting difference calculation is used as a confidence measure or translated into a confidence measure and a confidence indicator output **960** is generated accordingly. Alternatively, or in addition to a confidence measure, a probe off condition can be indicated if the difference calculation is larger than a predetermined value or the confidence measure is less than a predetermined value. In another embodiment, a correlation calculator is used in place of the difference calculation.

[0019] FIG. **10** illustrates a family of data clusters **1000** shown in two dimensions by way of example. Each data cluster **1000** represents NP ratios clinically measured across a population for specific values **1020** of a selected parameter *P*, such as P_1 , P_2 , P_3 and P_4 as shown. Each data cluster **1000** defines a region **1010** of NP ratios measured for a particular parameter value **1020** and has a probability distribution, such as a normal distribution, over the indicated region **1010**.

[0020] For example, the clinical data can be organized as a table of known values of *P*, corresponding NP ratios measured over a population, and the relative number of occurrences of particular NP ratio values for each value of *P*. The relative number of occurrences of particular NP ratio values for a particular value of *P* yields an NP ratio probability distribution for that value of *P*. Thus, each *P* value **1020** in the table has a corresponding data cluster **1000** of measured NP ratios and an associated probability distribution for those NP ratios.

[0021] FIG. **11** illustrates yet another embodiment of a physiological parameter confidence measurement system **1100** utilizing NP data clusters and corresponding probability distributions, such as described with respect to FIG. **10**, above. The confidence measurement system **1100** has input NP ratios **1110** measured in response to a multiple wavelength sensor, a parameter estimator **1120**, reference data clusters **1140** and a probability calculator **1150**. The parameter estimator **1120** inputs the NP ratios **1110** so as to generate a parameter estimate **1130**, such as described with respect to other embodiments, above. In one embodiment, the reference data clusters **1140**, such as described with respect to FIG. **10**, are stored in a memory device, such as an EPROM. The estimated parameter **1130** is compared with the reference data clusters **1140** so as to determine the closest region **1010** (FIG. **10**) or closest overlapping portion of two regions **1010** (FIG. **10**). The probability calculator **1150** computes a probability based upon the distribution

above the selected region **1010** (FIG. **10**). A confidence measure is also derived based upon the calculated probability **1150**. In a particular embodiment, the confidence measure is the calculated probability. A confidence indicator **1160** is generated in response to the confidence measure. In one embodiment, if the confidence probability or the calculated confidence measure is below a predetermined threshold, a probe-off indicator **1170** is generated. In particular embodiments, the confidence indicator **1160** or probe-off indicator **1170** or both may be alphanumeric or digital displays, optical indicators or alarms or similar audible indicators, to name a few.

[0022] A physiological parameter confidence measurement system has been disclosed in detail in connection with various embodiments. These embodiments are disclosed by way of examples only and are not to limit the scope of the claims that follow. One of ordinary skill in art will appreciate many variations and modifications.

Claims

1. A method of determining a measure of confidence in a physiological parameter, the physiological parameter determined by transmitting multiple wavelengths of optical radiation into a tissue site and detecting the optical radiation after tissue attenuation, the method comprising:

deriving physiological data responsive to the intensity of multiple wavelengths of optical radiation transmitted into a tissue site and detected after tissue attenuation;

estimating a physiological parameter based upon the physiological data;

providing a physiological data reference;

obtaining at least one data cluster from the physiological data reference; and

determining a measure of confidence in the estimated physiological parameter based upon the at least one data cluster and the derived physiological data;

wherein the physiological data comprises ratios of normalized plethysmographs (NP ratios), wherein a normalized plethysmograph is calculated by normalizing an AC detector response at a particular wavelength by a DC detector response at that wavelength.

2. The method according to claim 1 wherein the providing step comprises:

predetermining the physiological data for known values of the physiological parameter across a sample population;

clustering the data according to the physiological parameter values; and

storing the data clusters so as to be retrievable

according to the physiological parameter values.

3. The method according to claim 1 wherein the obtaining step comprises selecting the at least one data cluster according to the estimated physiological parameter.
4. The method according to claim 3 wherein the selecting step comprises:
 - determining at least one data cluster having a corresponding physiological parameter value closest to the estimated physiological parameter; and
 - reading the determined at least one data cluster from the memory.
5. The method according to claim 1 or 4 wherein the physiological parameter is at least one of SpO₂, MetHb and HbCO.
6. The method according to claim 5 wherein the data clusters are a plurality of parameteric curves of NP ratio versus wavelength.
7. A confidence measurement system (500) comprising:
 - a plurality of physiological data responsive to the intensity of multiple wavelengths of optical radiation transmitted into a tissue site and detected after tissue attenuation;
 - a parameter estimator (520) configured to input the physiological data and output an estimate of a physiological parameter;
 - a physiological data reference (540) having a plurality of data clusters (545) corresponding to known values of the physiological parameter; and
 - a confidence calculator (550) configured to compare the physiological data with the data clusters (545) so as to calculate a measure of confidence in the physiological parameter estimate; wherein the physiological data comprises a plurality of ratios of normalized plethysmographs corresponding to the multiple wavelengths of optical radiation, wherein a normalized plethysmograph is calculated by normalizing an AC detector response at a particular wavelength by a DC detector response at that wavelength.
8. The confidence measurement system according to claim 7 wherein the parameter estimator (520) comprises a value calculation corresponding to at least one of SpO₂, HbCO, HbMet, Hbt, fractional oxygen saturation, bilirubin and glucose.

Patentansprüche

1. Verfahren zur Bestimmung eines Maßes für die Zuverlässigkeit eines physiologischen Parameters, wobei der physiologische Parameter bestimmt wird, indem mehrere Wellenlängen optischer Strahlung in eine Gewebestelle transmittiert werden und die optische Strahlung nach der Gewebeabschwächung detektiert wird, wobei das Verfahren aufweist:
 - Ableiten physiologischer Daten ansprechend auf die Intensität mehrerer Wellenlängen optischer Strahlung, die in eine Gewebestelle transmittiert und nach der Gewebeabschwächung detektiert wird;
 - Schätzen eines physiologischen Parameters basierend auf den physiologischen Daten;
 - Bereitstellen einer physiologischen Datenreferenz;
 - Gewinnen wenigstens eines Datenclusters aus der physiologischen Datenreferenz; und
 - Bestimmen eines Maßes für die Zuverlässigkeit des geschätzten physiologischen Parameters basierend auf dem wenigstens einen Datencluster und den abgeleiteten physiologischen Daten;
 - wobei die physiologischen Daten Verhältnisse normierter Plethysmographen (NP-Verhältnisse) sind, wobei ein normierter Plethysmograph berechnet wird, indem eine Reaktion eines Wechselstromdetektors bei einer bestimmten Wellenlänge durch eine Reaktion eines Gleichstromdetektors bei dieser Wellenlänge normiert wird.
2. Verfahren nach Anspruch 1, wobei der Bereitstellungsschritt aufweist:
 - Vorbestimmen der physiologischen Daten für bekannte Werte des physiologischen Parameters über eine Probenpopulation;
 - Clustern der Daten gemäß den physiologischen Parameterwerten; und
 - Speichern der Datencluster, so dass sie gemäß den physiologischen Parameterwerten abrufbar sind.
3. Verfahren nach Anspruch 1, wobei der Gewinnungsschritt das Auswählen wenigstens eines Datenclusters gemäß dem geschätzten physiologischen Parameter aufweist.
4. Verfahren nach Anspruch 3, wobei der Auswahlsschritt aufweist:
 - Bestimmen wenigstens eines Datenclusters mit einem entsprechenden physiologischen Parameterwert, der dem geschätzten physiologi-

schen Parameter am nächsten ist; und
Auslesen des bestimmten mindestens einen
Datenclusters aus dem Speicher.

5. Verfahren nach Anspruch 1 oder 4, wobei der physiologische Parameter und/oder MetHb und/oder HbCO ist. 5
6. Verfahren nach Anspruch 5, wobei die Datencluster mehrere Parameterkurven von NP-Verhältnissen gegenüber der Wellenlänge sind. 10
7. System zur Zuverlässigkeitsmessung (500), das aufweist:
- mehrere physiologische Daten, die auf die Intensität mehrerer Wellenlängen optischer Strahlung, die in eine Gewebestelle transmittiert und nach der Gewebeabschwächung detektiert wird, ansprechen; 15
- eine Parameterschätzeinrichtung (520), die konfiguriert ist, um die physiologischen Daten einzugeben und eine Schätzung eines physiologischen Parameters auszugeben; 20
- eine physiologische Datenreferenz (540) mit mehreren Datenclustern (545), die bekannten Werten des physiologischen Parameters entsprechen; und 25
- eine Zuverlässigkeitsberechnungseinrichtung (550), die konfiguriert ist, um die physiologischen Daten mit den Datenclustern (545) zu vergleichen, um ein Maß für die Zuverlässigkeit der physiologischen Datenschätzung zu berechnen; 30
- wobei die physiologischen Daten mehrere Verhältnisse normierter Plethysmographen aufweisen, die den mehreren Wellenlängen optischer Strahlung entsprechen, wobei ein normierter Plethysmograph berechnet wird, indem eine Reaktion eines Wechselstromdetektors bei einer bestimmten Wellenlänge durch eine Reaktion eines Gleichstromdetektors bei dieser Wellenlänge normiert wird. 40
8. System zur Zuverlässigkeitsmessung nach Anspruch 7, wobei die Parameterschätzeinrichtung (520) eine Wertberechnung aufweist, die und/oder HbCO und/oder HbMet, Hbt und/oder die fraktionelle Sauerstoffsättigung und/oder Bilirubin und/oder Glukose entspricht. 45 50

Revendications

1. Procédé pour déterminer une mesure de confiance en un paramètre physiologique, le paramètre physiologique étant déterminé par émission de multiples longueurs d'onde d'un rayonnement optique dans

un site tissulaire et détection du rayonnement optique après atténuation par le tissu, le procédé comprenant :

la dérivation de données physiologiques sensibles à l'intensité de multiples longueurs d'onde d'un rayonnement optique émis dans un site tissulaire et détecté après atténuation par le tissu ;
l'estimation d'un paramètre physiologique sur la base des données physiologiques ;
la fourniture d'une référence de données physiologiques ;
l'obtention d'au moins une grappe de données à partir de la référence de données physiologiques ; et
la détermination d'une mesure de confiance en le paramètre physiologique estimé sur la base de l'au moins une grappe de données et des données physiologiques dérivées ;
dans lequel les données physiologiques comprennent des rapports de pléthysmographes normalisés (rapports NP), où un pléthysmographe normalisé est calculé par normalisation d'une réponse de détecteur en courant alternatif à une longueur d'onde particulière par une réponse de détecteur en courant continu à cette longueur d'onde.

2. Procédé selon la revendication 1, dans lequel l'étape de fourniture comprend :

la prédétermination des données physiologiques pour des valeurs connues du paramètre physiologique sur une population échantillon ;
le regroupement des données conformément aux valeurs du paramètre physiologique ; et
le stockage des grappes de données de façon qu'elles soient récupérables en fonction des valeurs du paramètre physiologique.

3. Procédé selon la revendication 1, dans lequel l'étape d'obtention comprend la sélection de l'au moins une grappe de données en fonction du paramètre physiologique estimé.

4. Procédé selon la revendication 3, dans lequel l'étape de sélection comprend :

la détermination d'au moins une grappe de données ayant une valeur de paramètre physiologique correspondante la plus proche du paramètre physiologique estimé ; et
la lecture à partir de la mémoire de l'au moins une grappe de données déterminée.

5. Procédé selon la revendication 1 ou 4, dans lequel le paramètre physiologique est au moins l'un parmi SpO₂, MetHb et HbCO.

6. Procédé selon la revendication 5, dans lequel les grappes de données sont constituées d'une pluralité de courbes paramétriques de rapport NF en fonction de la longueur d'onde. 5
7. Système de mesure de confiance (500) comprenant : 10
- une pluralité de données physiologiques sensibles à l'intensité de multiples longueurs d'onde d'un rayonnement optique émis dans un site tissulaire et détecté après atténuation par le tissu ; un estimateur de paramètre (520) configuré pour entrer les données physiologiques et délivrer en sortie une estimation d'un paramètre physiologique ; 15
- une référence de données physiologiques (540) ayant une pluralité de grappes de données (545) correspondant à des valeurs connues du paramètre physiologique ; et 20
- un calculateur de confiance (550) configuré pour comparer les données physiologiques avec les grappes de données (545) de façon à calculer une mesure de confiance dans l'estimation de paramètre physiologique ; 25
- dans lequel les données physiologiques comprennent une pluralité de rapports de pléthysmographes normalisés correspondant aux multiples longueurs d'onde d'un rayonnement optique, où un pléthysmographe normalisé est calculé par normalisation d'une réponse de détecteur en courant alternatif à une longueur d'onde particulière par une réponse de détecteur en courant continu à cette longueur d'onde. 30
- 35
8. Système de mesure de confiance selon la revendication 7, dans lequel l'estimateur de paramètre (520) comprend un calcul de valeur correspondant à au moins l'un parmi SpO₂, HbCO, HbMet, Hbt, la saturation en oxygène fractionnée, la bilirubine, et le glucose. 40
- 45
- 50
- 55

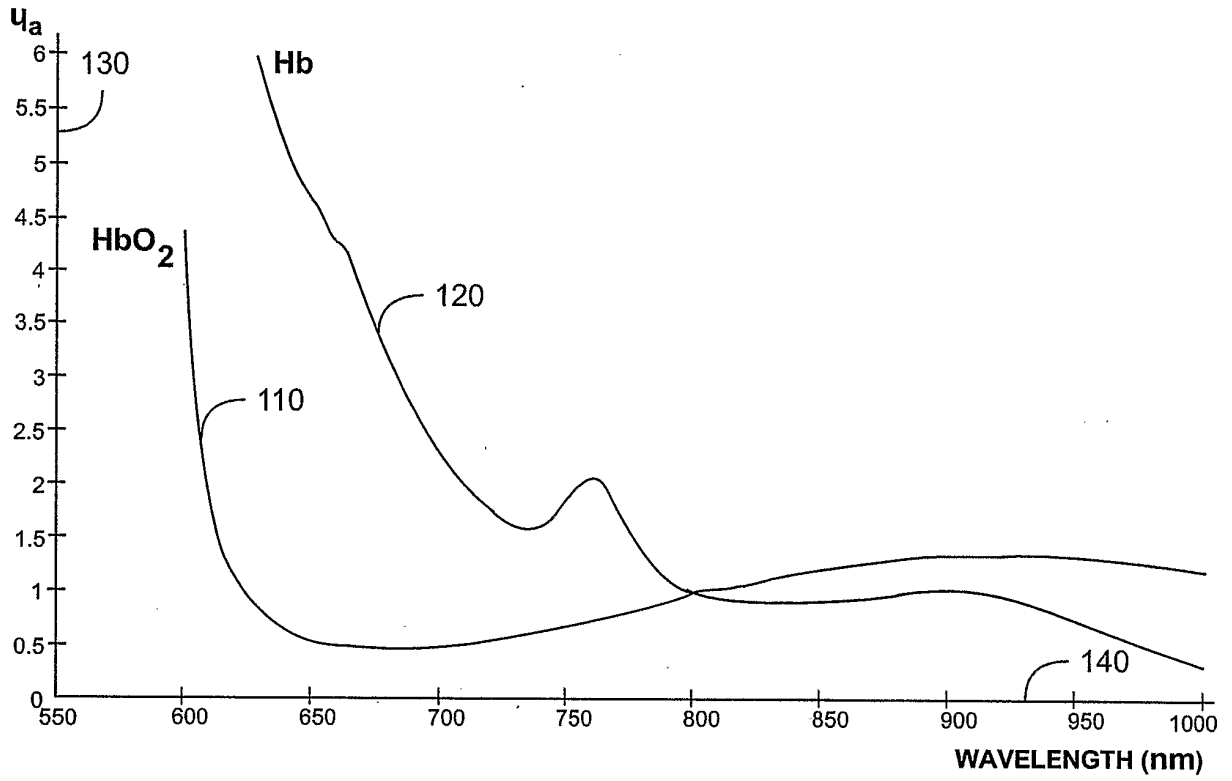

FIG. 1

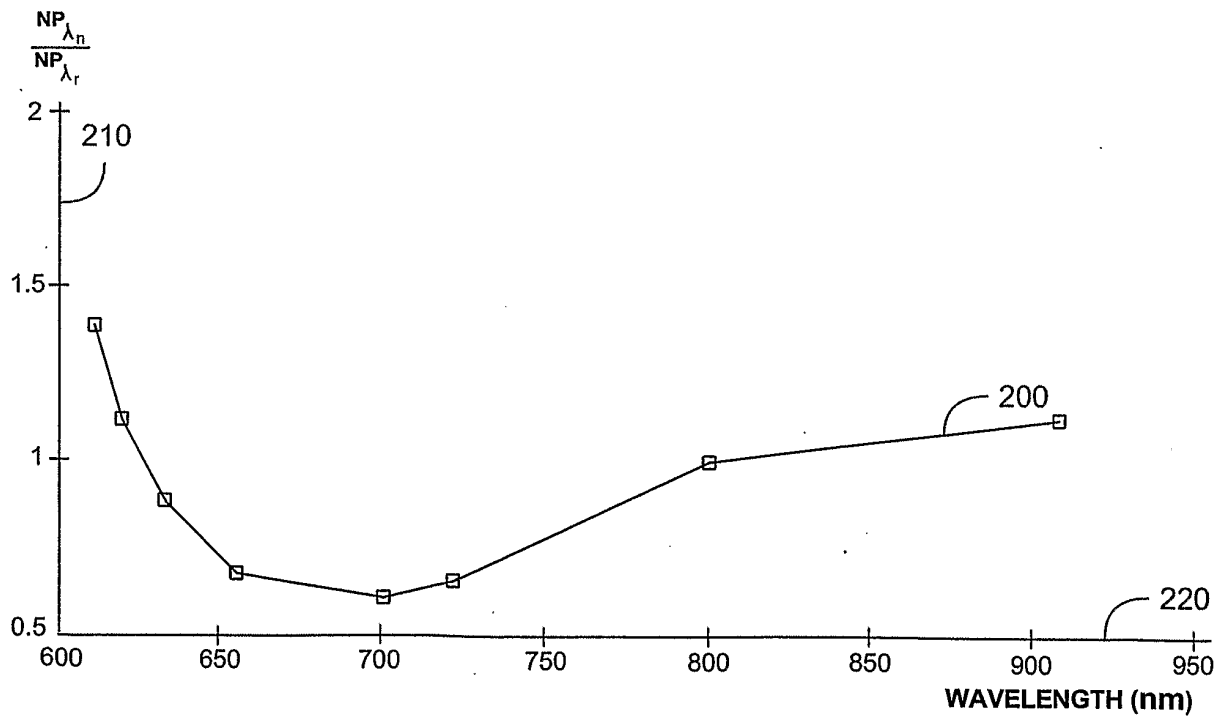

FIG. 2

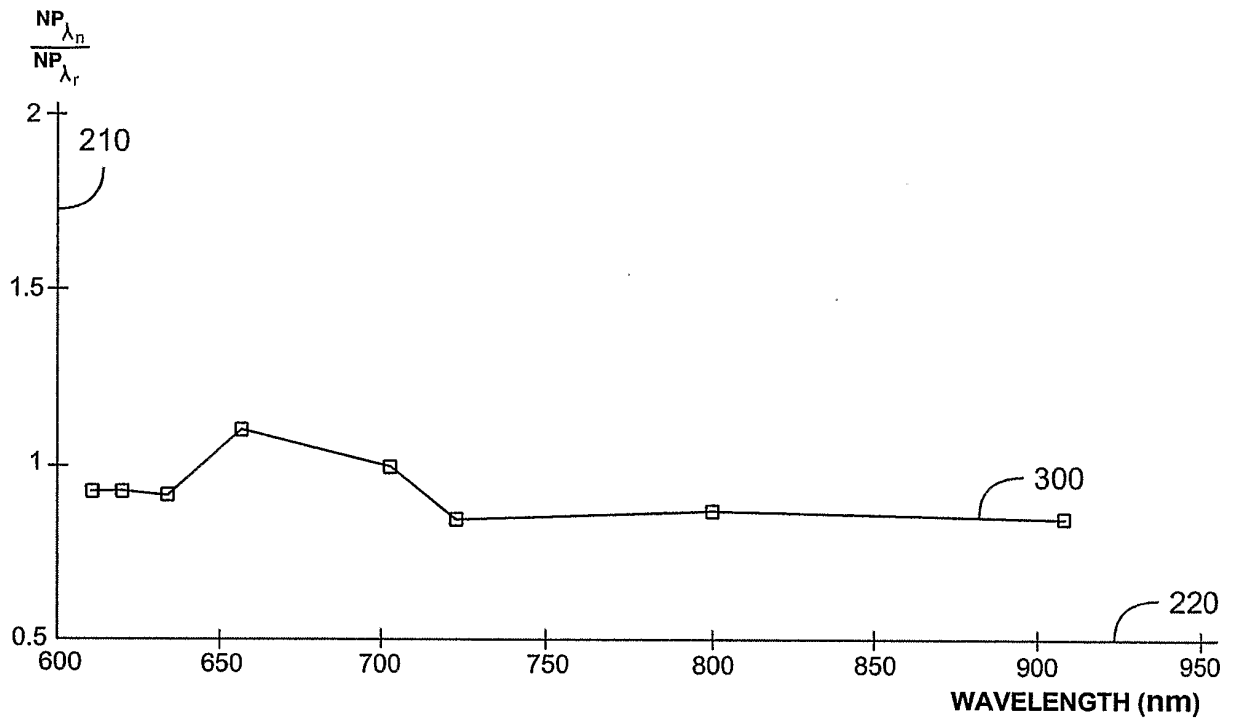

FIG. 3

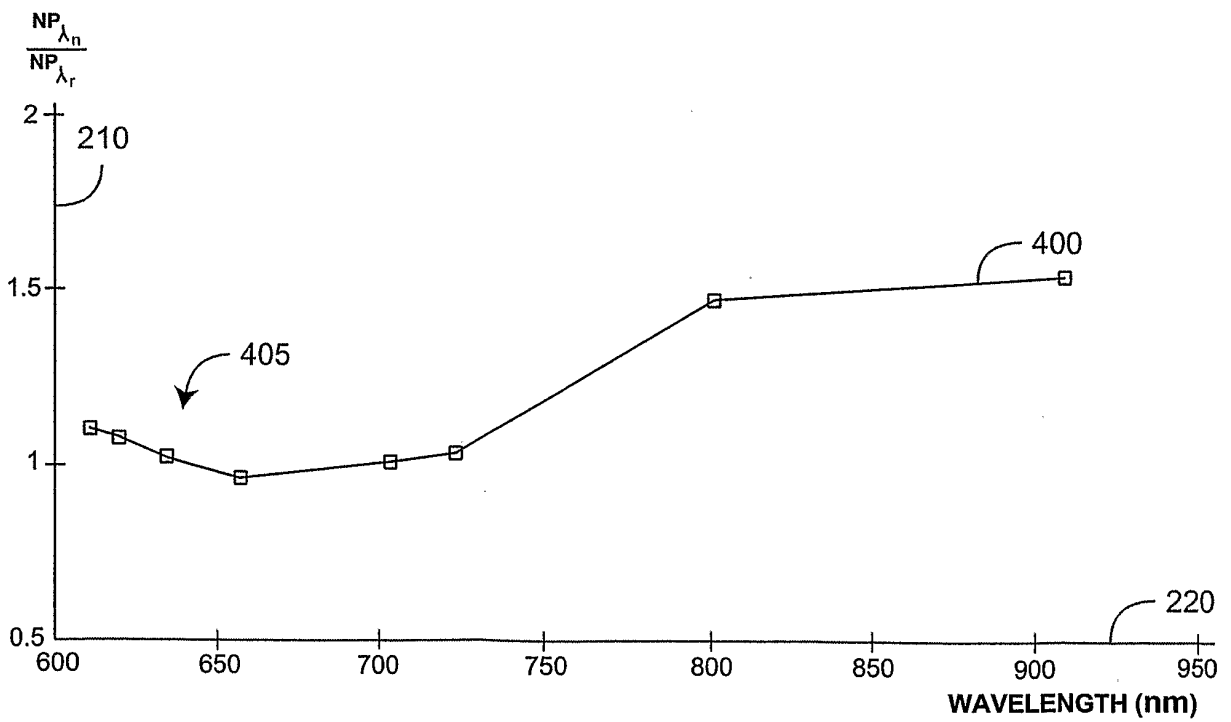

FIG. 4

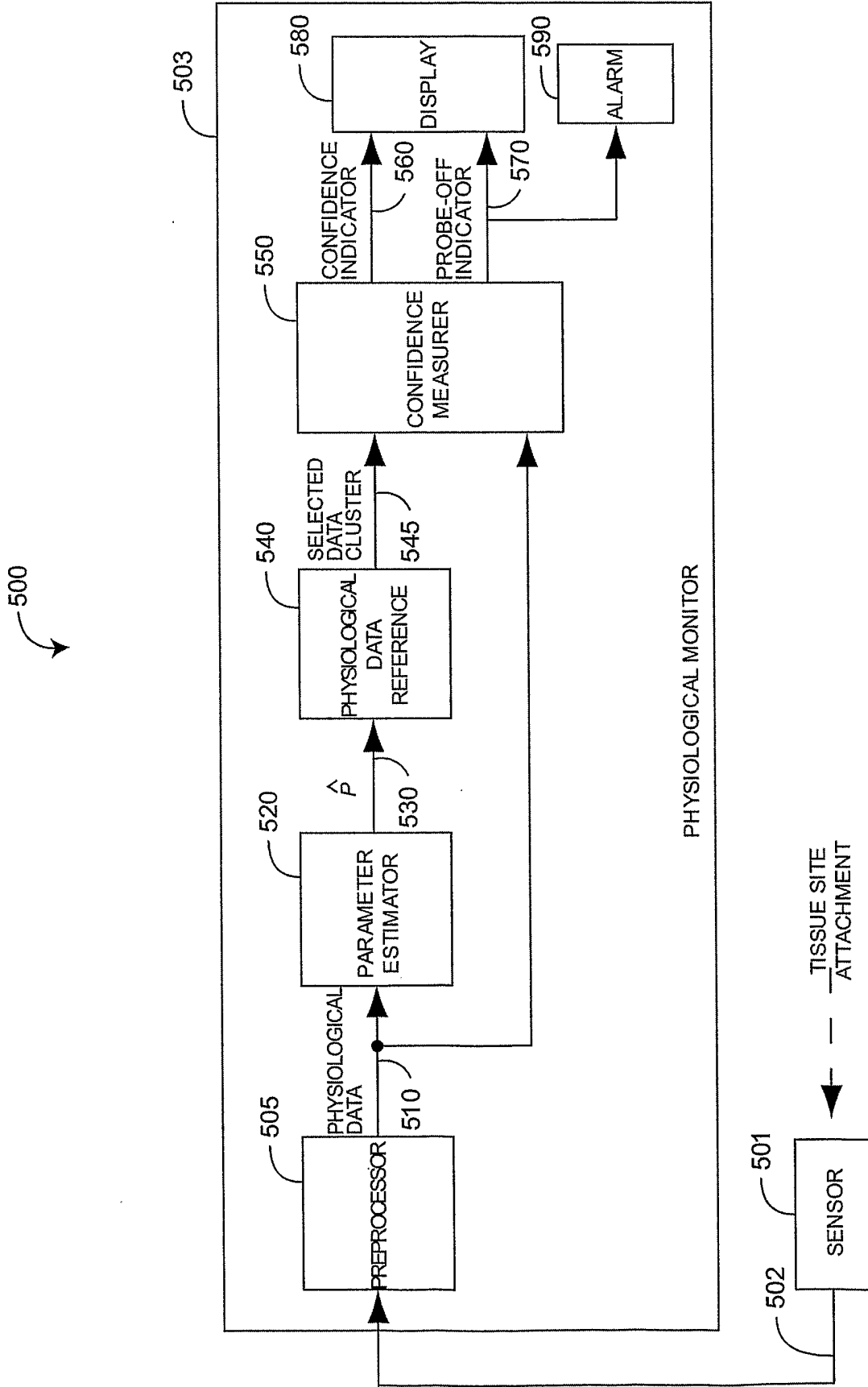

FIG. 5

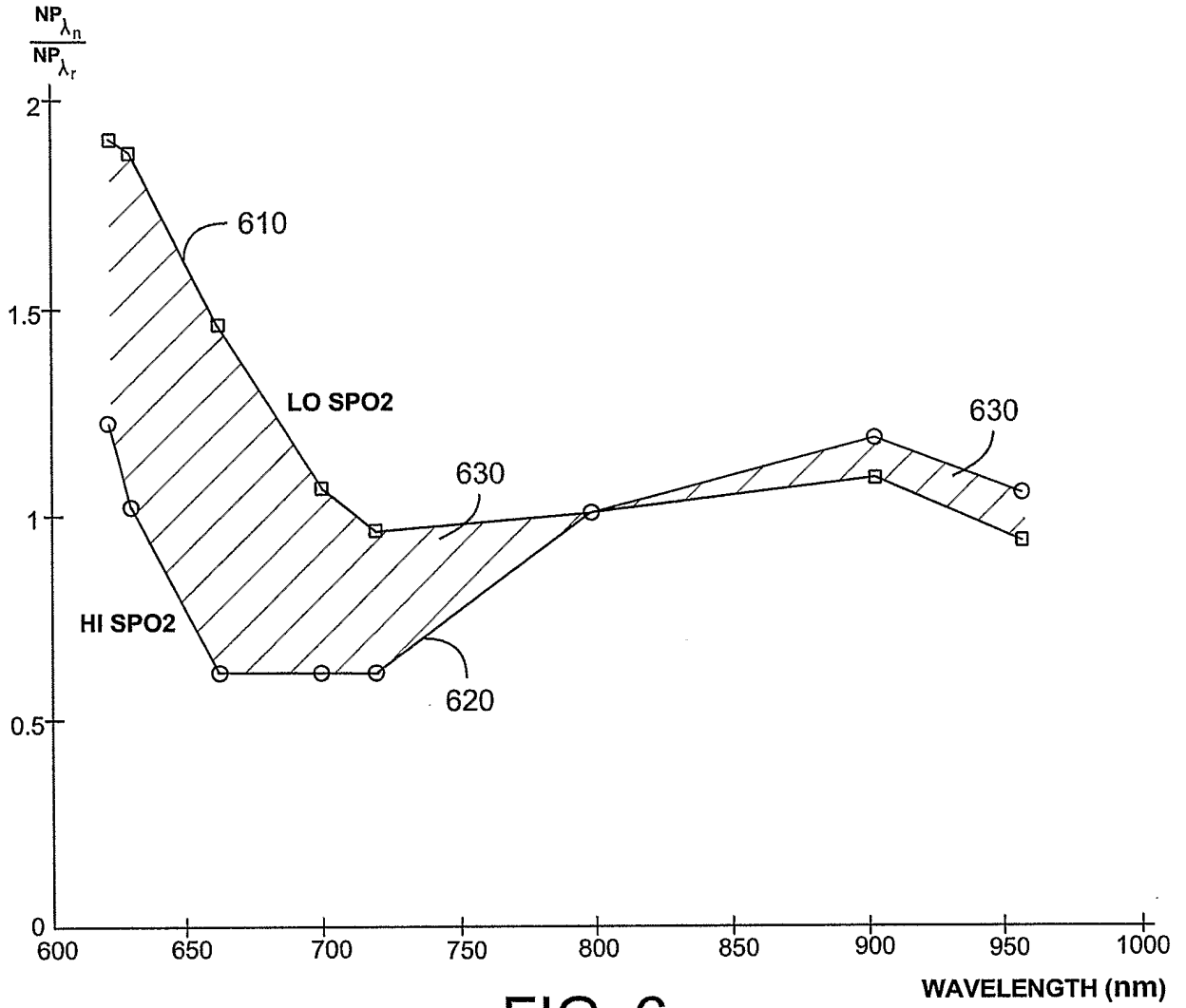

FIG. 6

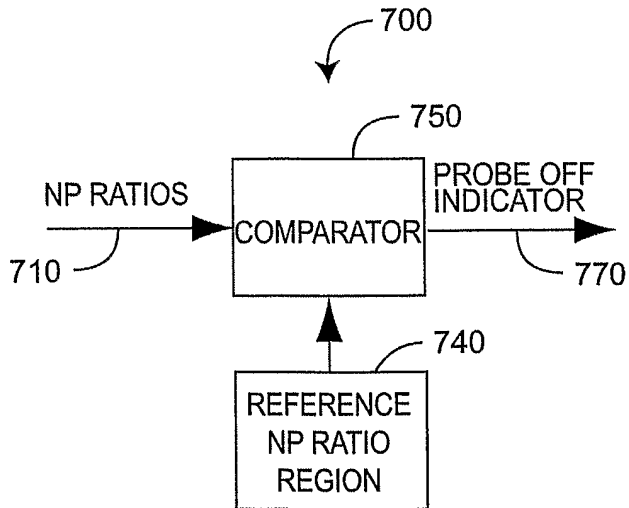

FIG. 7

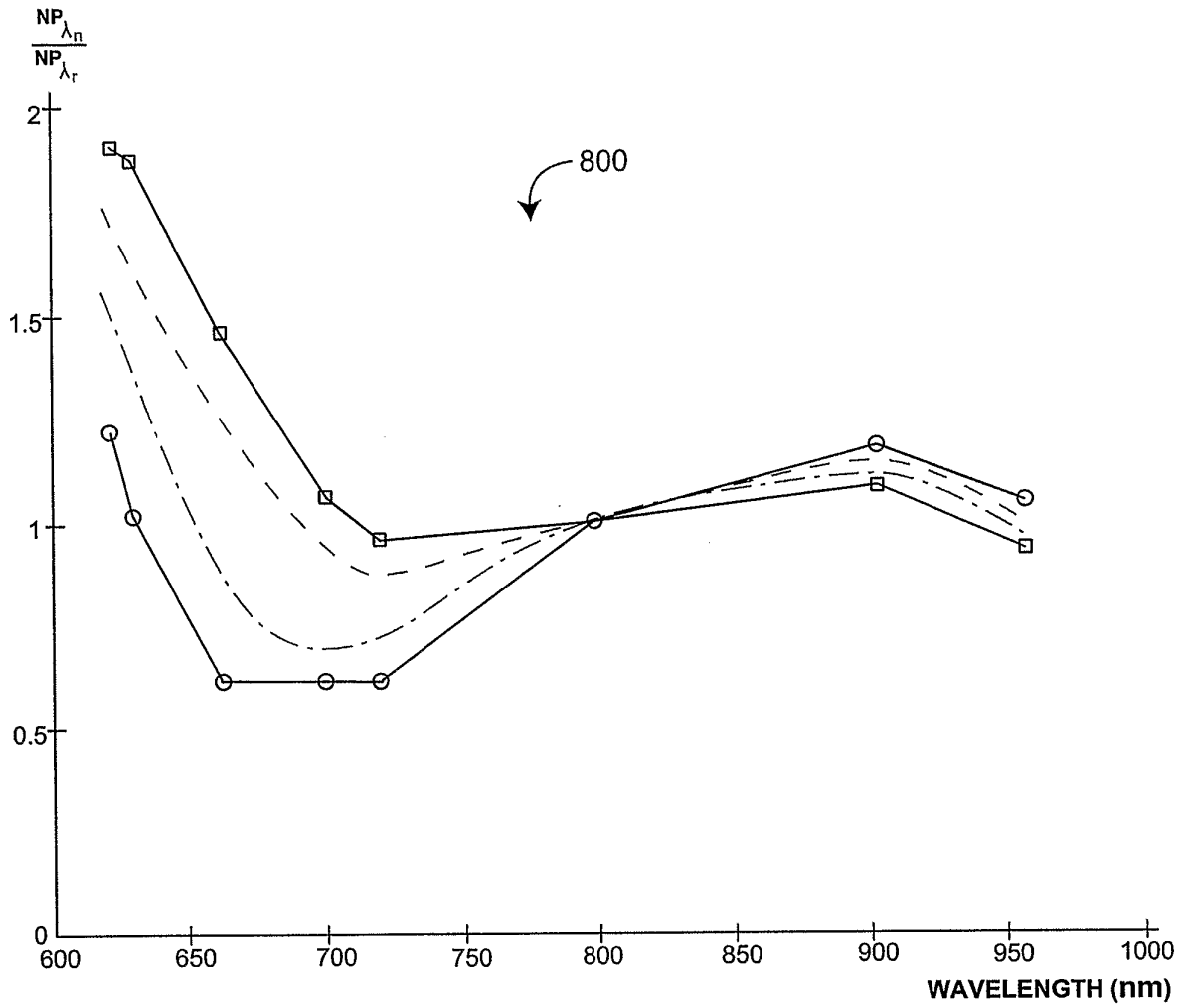

FIG. 8

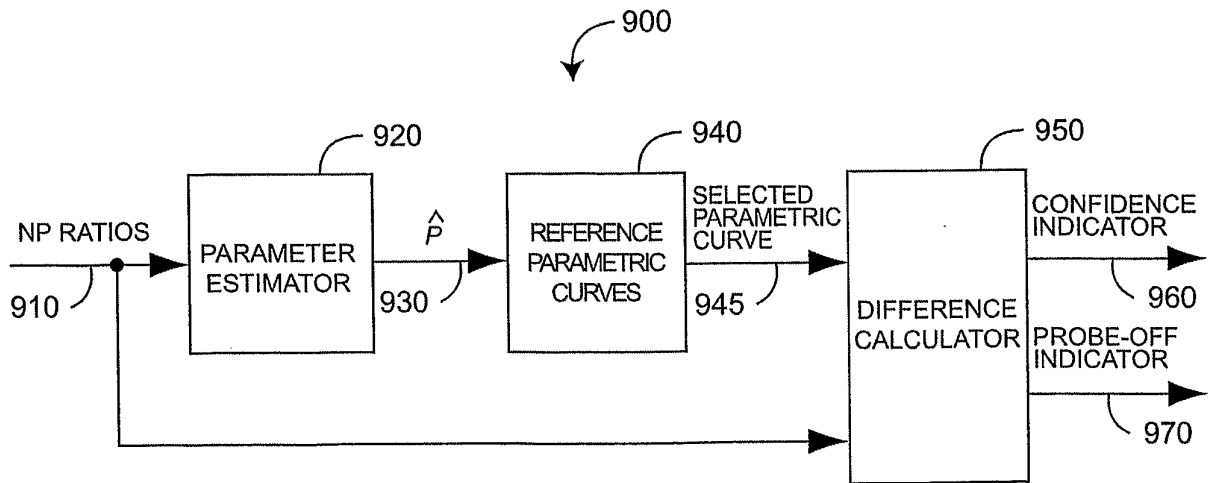

FIG. 9

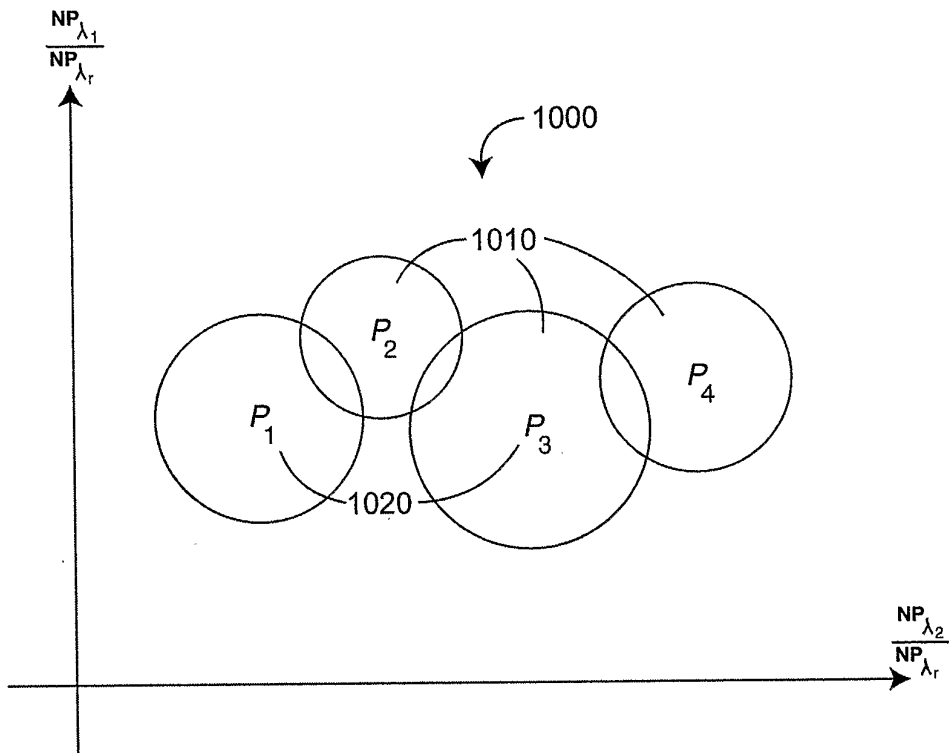

FIG. 10

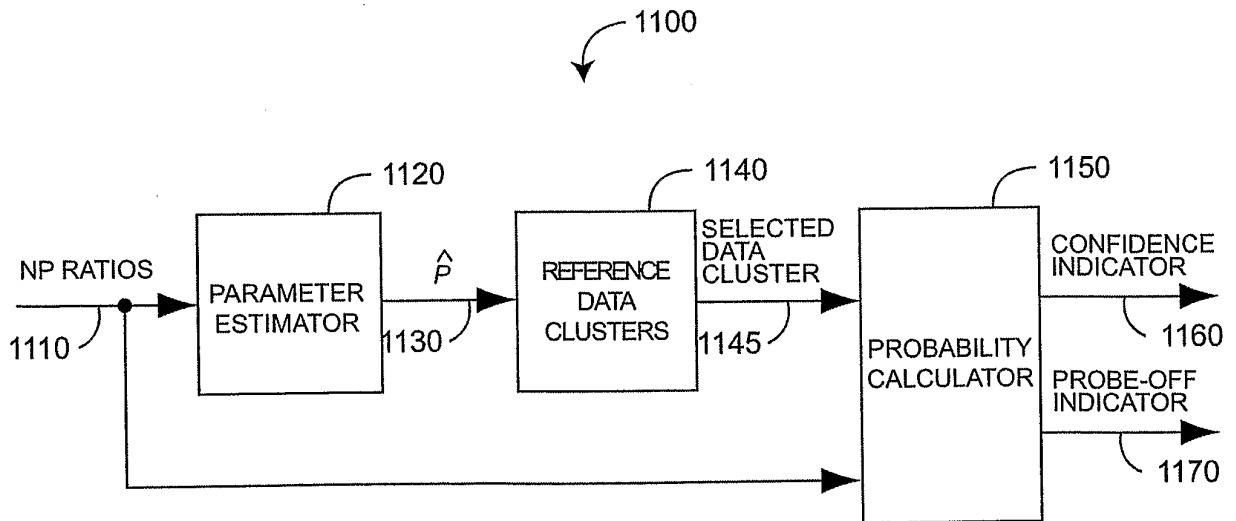

FIG. 11

REFERENCES CITED IN THE DESCRIPTION

This list of references cited by the applicant is for the reader's convenience only. It does not form part of the European patent document. Even though great care has been taken in compiling the references, errors or omissions cannot be excluded and the EPO disclaims all liability in this regard.

Patent documents cited in the description

- US 6770028 B [0003]
- US 6658276 B [0003]
- US 6157850 A [0003]
- US 6002952 A [0003]
- US 5769785 A [0003]
- US 5758644 A [0003]
- US 4653498 A [0003]
- US 6996427 B [0014]
- US 6606511 B [0014]
- US 6654624 B [0014]
- US 6771994 B [0014]

专利名称(译)	生理参数信心测量		
公开(公告)号	EP1860989A1	公开(公告)日	2007-12-05
申请号	EP2006736668	申请日	2006-03-01
[标]申请(专利权)人(译)	MASIMO LAB		
申请(专利权)人(译)	MASIMO实验室, INC.		
当前申请(专利权)人(译)	MASIMO实验室, INC.		
[标]发明人	DIAB MOHAMED LAMEGO MARCELO AL ALI AMMAR		
发明人	DIAB, MOHAMED LAMEGO, MARCELO AL-ALI, AMMAR		
IPC分类号	A61B5/00		
CPC分类号	A61B5/02416 A61B5/14552 A61B5/6832 A61B5/746 A61B2562/08 A61B2562/085 A61B2562/222 G06F19/3418 G16H10/40 G16H40/67 Y10S439/909 A61B1/00 A61B5/0022 A61B5/0205 A61B5/02427 A61B5/0261 A61B5/0295 A61B5/14532 A61B5/14546 A61B5/1455 A61B5/14551 A61B5/1495 A61B5 /6815 A61B5/6826 A61B5/6829 A61B5/6838 A61B5/7221 A61B5/7246 A61B5/7275 A61B5/7278 A61B5/7405 A61B5/742 A61B5/7475 H05K999/99		
代理机构(译)	法思博事务所		
优先权	60/657596 2005-03-01 US 60/657759 2005-03-01 US 60/657268 2005-03-01 US 60/657281 2005-03-01 US		
其他公开文献	EP1860989B1		
外部链接	Espacenet		

摘要(译)

本发明涉及一种在患者监视器上显示生理参数的颜色编码指示的方法，该方法包括非侵入地确定第一生理参数的至少一个测量值和第二生理参数的至少一个测量值，将第一生理参数与第一生理参数相关联。具有第一颜色的生理参数，将第二生理参数与不同于第一颜色的第二颜色相关联，在患者监视器上显示具有第一颜色的第一指示，第一指示指示至少一个测量值第一生理参数，并在患者监视器上显示具有第二颜色的第二指示，第二指示指示第二生理参数的至少一个测量值。