



(12) **EUROPEAN PATENT APPLICATION**

(43) Date of publication:
30.03.2011 Bulletin 2011/13

(51) Int Cl.:
A61H 31/00 (2006.01) **A61N 1/39 (2006.01)**
G06F 19/00 (2011.01)

(21) Application number: **10075412.6**

(22) Date of filing: **23.06.2004**

(84) Designated Contracting States:
DE FR GB

(30) Priority: **27.06.2003 US 609001**
06.11.2003 US 704366

(62) Document number(s) of the earlier application(s) in accordance with Art. 76 EPC:
09006039.3 / 2 210 555
04253737.3 / 1 491 176

(71) Applicant: **Zoll Medical Corporation**
Chelmsford
Massachusetts 01824-4105 (US)

(72) Inventors:

- **Geheb, Frederick**
Danvers
Massachusetts 01923 (US)

- **Boucher, Donald R**
Andover
Massachusetts 01810 (US)
- **Freeman, Gary A**
Newton Center
Massachusetts 02159 (US)

(74) Representative: **Charig, Raymond Julian et al**
Potter Clarkson LLP
Park View House
58 The Ropewalk
Nottingham
NG1 5DD (GB)

Remarks:

This application was filed on 10-09-2010 as a divisional application to the application mentioned under INID code 62.

(54) **Method and apparatus for enhancement of chest compressions during CPR**

(57) An apparatus for assisting a rescuer in performing chest compressions during CPR on a victim, the apparatus comprising a pad or other structure configured to be applied to the chest near or at the location at which the rescuer applies force to produce the chest compressions, at least one sensor connected to the pad, the sensor being configured to sense movement of the chest or force applied to the chest, processing circuitry for

processing the output of the sensor to determine whether the rescuer is substantially releasing the chest following chest compressions, and at least one prompting element connected to the processing circuitry for providing the rescuer with information as to whether the chest is being substantially released following chest compressions. In particular, at least one velocity sensor is connected to the pad, the velocity sensor being configured to sense the velocity of movement of the chest.

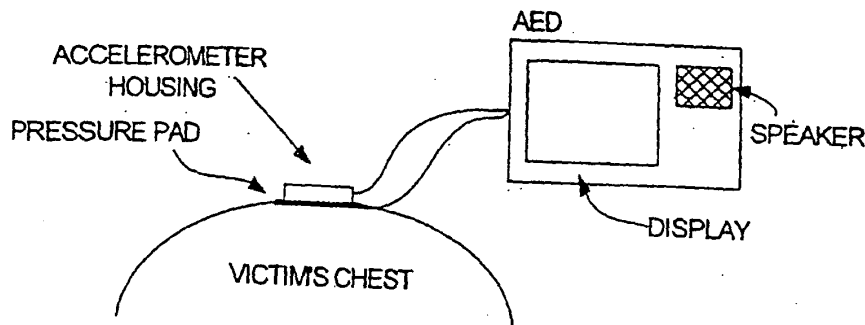

FIG. 1

Description**CROSS-REFERENCE TO RELATED APPLICATIONS**

5 [0001] This application is a continuation-in-part application of and claims priority to U.S. Application Serial No. 10/609,001, filed on June 27, 2003.

TECHNICAL FIELD

10 [0002] This invention relates to the devices for assisting cardiac resuscitation.

BACKGROUND

15 [0003] This invention relates to the field of cardiac resuscitation, and in particular to devices for assisting rescuers in performing chest compression during cardio-pulmonary resuscitation (CPR). Chest compression during CPR is used to mechanically support circulation in subjects with cardiac arrest, by maintaining blood circulation and oxygen delivery until the heart is restarted. The victim's chest is compressed by the rescuer, ideally at a rate and depth of compression in accordance with medical guidelines, e.g., the American Heart Association (AHA) guidelines. One key step for creating blood flow through the heart is to release the chest adequately after each chest compression. The chest should be released sufficiently to create a negative pressure in the chest, to facilitate venous filling of the heart and increased blood flow upon the next chest compression. If the chest is not released adequately, a positive thoracic pressure will remain which will hinder venous return and right atrial filling. Other key CPR parameters are maximal velocity of compression, compression depth, and average velocity. Compression depth and average velocity, together, provide good indication of potential blood flow volume. Maximal velocity of compression is an important factor in proper mitral valve closure and higher blood flow volume.

20 [0004] Sensors have been suggested for detecting the depth of chest compression. An accelerometer (with its output integrated to estimate depth) was disclosed, for example, in Freeman U.S. Application No. 09/794,320, U.S. Patent No. 6,306,107 and U.S. Patent No. 6,390,996. Force (pressure) sensors were disclosed, for example, in Groenke U.S. Patent No. 6,125,299. Force sensors provided no way of determining absolute displacement, as the compliance of the thoracic cage varies considerably from person to person. Accelerometers do not provide an indication of whether or not the chest is being released. They calculate displacement by double integration, which can result in a significant DC offset. U.S. Patent No. 6,306,107 attempted to address the DC offset problem by incorporating a force sensor as a switch to indicate onset and conclusion of compression. The prior art has also employed mechanical pressure gauges to indicate to the rescuer the amount of force or pressure being applied to the chest. But these prior art uses of an accelerometer and/or force sensor have not provided a good solution to providing the rescuer with useful feedback as to whether the chest has been sufficiently released. Differences in compliance of the thoracic cage from one individual to another means that each individual will generally be able to support different amounts of force on the sternum without significant displacement occurring.

30 [0005] Increasingly, automated external defibrillators (AEDs) are used by rescuers treating victims of cardiac arrest for the delivery of defibrillatory shocks with the minimum of delay. The algorithms contained in the currently-available AEDs call for 'hands off' periods during which electrocardiographic (ECG) analysis is performed by the device and the rescuer withholds compressions. Compressions must be withheld because the accuracy of current rhythm analysis algorithms in AEDs is severely degraded by the artifact induced by the chest compressions. These AEDs also call for the rescuer to check for pulse or for signs of circulation during which time no compressions are performed. It has been shown in several studies that interruptions in the performance of chest compressions of as short a time as 20 seconds can dramatically reduce the probability of the return of spontaneous circulation (ROSC), a key survival measure. Other studies have also shown that the minimum amount of time required for the 'hands off' period is 20 seconds. There is therefore a need for the ability of AEDs to perform rhythm analysis while the rescuer continues with the chest compressions uninterrupted.

SUMMARY

45 [0006] In a first aspect, the invention features an apparatus for assisting a rescuer in performing chest compressions during CPR on a victim, the apparatus comprising a pad or other structure configured to be applied to the chest near or at the location at which the rescuer applies force to produce the chest compressions, at least one sensor connected to the pad, the sensor being configured to sense movement of the chest or force applied to the chest, processing circuitry for processing the output of the sensor to determine whether the rescuer is substantially releasing the chest following chest compressions, and at least one prompting element connected to the processing circuitry for providing the rescuer

with information as to whether the chest is being substantially released following chest compressions.

[0007] Preferred implementations of this aspect of the invention may incorporate one or more of the following. The pad or other structure may be a pad to which force is applied by rescuer. The sensor may include an accelerometer. The sensor may include a force (or pressure) sensor. The sensor may include a velocity sensor. The sensor may include both a force (or pressure) sensor and an accelerometer or velocity sensor. The prompting device may include a speaker for delivering an audible message to the rescuer. The prompting device may include a display for delivering a visual message to the rescuer. The apparatus may be part of an external defibrillator. The external defibrillator may be an AED. The processing circuitry may include a digital processor executing software. Determining whether the rescuer is substantially releasing the chest may comprise analyzing motion of the chest. Analyzing motion of the chest may comprise analyzing features or the shape of a waveform representing chest motion. The apparatus may comprise both a sensor to sense movement of the chest and a sensor to sense force applied to the chest, and the processing circuitry may use outputs of both sensors to provide information representative of chest compliance. The information representative of chest compliance may be used to determine a level of applied pressure/force that corresponds to a substantial release of the chest.

[0008] In a second aspect, the invention features an apparatus for assisting a rescuer in performing chest compressions during CPR on a victim, the apparatus comprising a pad or other structure configured to be applied to the chest near or at the location at which the rescuer applies force to produce the chest compressions, and at least one velocity sensor connected to the pad, the velocity sensor being configured to sense the velocity of movement of the chest.

[0009] Preferred implementations of this aspect of the invention may incorporate one or more of the following. The apparatus may further comprise processing circuitry for processing the output of the velocity sensor to estimate the displacement of the chest. The processing circuitry may have the capability to integrate an output of the velocity sensor. The velocity sensor may be configured to be located approximately adjacent to the location at which the body is compressed. The velocity sensor may be configured to be positioned to sense the relative velocity between opposite surfaces of the chest. The velocity sensor may comprise a conductor and a magnet, and velocity may be sensed by sensing the current induced in the conductor by relative motion between the conductor and the magnet. The magnet may comprise one of a permanent magnet and an electromagnet. The conductor and magnet may be positioned on opposite surfaces of the chest. The conductor may comprise a coil that is unitary with a defibrillation electrode pad. The conductor and magnet each may comprise a coil that is unitary with a defibrillation electrode pad. The magnet may comprise an electromagnet and the electromagnet may produce a magnetic field that oscillates at a frequency greater than 1 KHz, and may further comprise coil detection circuitry to which the coil is connected, wherein the coil detection circuitry may be capable of synchronously demodulating the detected signal to reduce susceptibility to drift and noise. The apparatus may further comprise circuitry for acquiring ECG signals from the victim, and the processing circuitry may have the capability to process the output of the velocity sensor and the ECG signals to reduce ECG artifacts from chest compressions by use of velocity sensor output.

[0010] In a third aspect, the invention features an apparatus for assisting a rescuer in performing chest compressions during CPR on a victim, the apparatus comprising a pad or other structure configured to be applied to the chest near or at the location at which the rescuer applies force to produce the chest compressions, at least one motion sensor connected to the pad, the motion sensor being configured to sense movement of the chest, processing circuitry for processing the output of the motion sensor to estimate the maximum velocity of compression of the chest, and at least one prompting device connected to the processing circuitry for providing the rescuer with information representative of the maximum velocity of compression. In preferred implementations of this aspect of the invention, the motion sensor may comprise a velocity sensor.

[0011] In a fourth aspect, the invention features a method of determining chest compression during CPR, the method comprising applying a motion sensor to the chest of a patient at a location near or at the location at which a rescuer applies force to produce chest compressions, determining chest displacement from analysis of features of the motion waveform produced by the motion sensor.

[0012] Preferred implementations of this aspect of the invention may incorporate one or more of the following. The motion sensor maybe a velocity sensor. The motion sensor may be an accelerometer. The method may further comprise deciding from the analysis of features of the acceleration waveform whether or not a rescuer has sufficiently released the patient's chest. The method may further comprise processing the output of the accelerometer to provide velocity and acceleration waveforms. The method may further comprise processing the output of the accelerometer to provide velocity and acceleration waveforms, and analyzing the velocity and acceleration waveforms to determine whether or not a rescuer has sufficiently released the patient's chest. The analysis of velocity waveforms may include determining the maximal velocity of compression. Determining chest displacement from analysis of features may comprise determining onset and completion times for a compression cycle from the features of the waveforms. Determining chest displacement may further comprise integrating the acceleration waveform over a time segment defined by the onset and completion times. The method may further comprise analyzing the features of the upstroke portion of the waveforms to determine whether there has been sufficient release of the chest. The method may further comprise prompting a

rescuer based as to whether compressions are within desired limits on compression depth and compression release. The prompts to the rescuer may be based on multi-cycle trends, so that they are not immediately influenced by the rescuer taking a brief break in the application of CPR. The method may further comprise determining chest compliance, and using the determined chest compliance to adjust the level of pressure/force that the rescuer is permitted to apply at the end of a compression stroke without being prompted as to insufficiently releasing the chest. The features determined from the waveforms may include one or more of the following: width, amplitude, area, center of mass, skewness, height/width ratio, TAR, TAMPR and TWR. The features may be used to make a decision as to whether the chest of the victim has been sufficiently released. Decisions may be made using either standard decision logic, fuzzy-logic decision methodology, or statistical estimation.

[0013] In a fifth aspect, the invention features a method of analyzing ECG signals during application of CPR, the method comprising detecting ECG signals during application of chest compressions, detecting the output of a sensor from which information on the velocity of chest compressions can be determined, and using the information on the velocity to reduce at least one signal artifact in the ECG signal resulting from the chest compressions.

[0014] Preferred implementations of this aspect of the invention may incorporate one or more of the following. The sensor may be a velocity sensor, and the information on the velocity may be determined from the velocity sensor. The sensor may be an accelerometer, and the information on the velocity may be determined from integration of the output of the accelerometer. Using the information on the velocity to reduce at least one signal artifact in the ECG signal may comprise time aligning the ECG signals with the velocity. Using the information on the velocity to reduce at least one signal artifact in the ECG signal may comprise an adaptive filter that is adjusted to remove chest compression artifacts. Using the information on the velocity to reduce at least one signal artifact in the ECG signal may comprise feed forward active noise cancellation. Using the information on the velocity to reduce at least one signal artifact in the ECG signal may comprise determining a cutoff frequency for a filter that separates the ECG signal from chest compression artifacts.

[0015] In a sixth aspect, the invention features an apparatus for assisting a rescuer in performing chest compressions during CPR on a victim, the apparatus comprising a pad or other structure configured to be applied to the chest near or at the location at which the rescuer applies force to produce the chest compressions, at least one motion sensor connected to the pad, the motion sensor being configured to sense movement of the chest, at least one force (or pressure) sensor connected to the pad, the force sensor being configured to sense force applied to the chest, and processing circuitry for processing the output of the motion sensor and force sensor to estimate the compliance of the chest.

[0016] Preferred implementations of this aspect of the invention may incorporate one or more of the following. The estimated compliance and the output of the force sensor may be used to determine the depth of compression of the chest. The motion sensor may be an accelerometer, and the output of the accelerometer may be used primarily for estimating chest compliance, and compression depth during CPR may be estimated by using the estimated compliance to convert the output of the force sensor into estimated compression depth. The output of the accelerometer may be used during limited time intervals for estimating chest compliance, and outside of those limited time intervals chest compression may be determined from the estimated compliance and the output of the force sensor without substantial use of the output of the accelerometer. The estimated compliance and the output of the force sensor may be used to determine whether the chest has been substantially released.

[0017] In a seventh aspect, the invention features an apparatus for assisting a rescuer in performing chest compressions during CPR on a victim, the apparatus comprising a pad or other structure configured to be applied to the chest near or at the location at which the rescuer applies force to produce the chest compressions, at least one bistable mechanical element that when depressed provides tactile feedback to the hand of the rescuer upon the start of a compression and at the end of a compression.

[0018] Preferred implementations of this aspect of the invention may incorporate one or more of the following. The mechanical element may comprise a dome that collapses under pressure and returns to a dome shape on release of pressure. The bistable mechanical element may further provide audible feedback at least at the end of a compression. The tactile feedback at the end of a compression may occur at approximately an applied force corresponding to substantial release of the chest, so that the tactile feedback serves as feedback to the rescuer that the chest has been substantially released.

[0019] The invention provides numerous advantages. It provides a more accurate and detailed measure of compressions during CPR, e.g., by analyzing such compression/decompression cycle parameters as compression velocity and completeness of decompression release. And features of the velocity and acceleration waveforms may be analyzed to maximize CPR performance. E.g., the invention permits analysis of maximal velocity of compression, which is an important factor in proper mitral valve closure and higher blood flow volume.

[0020] The invention may obviate the need for a secondary information channel, e.g., a force sensor, to provide the accuracy necessary for the use of acceleration to accurately measure displacement. The invention includes new methods for the analysis of the acceleration waveform that allow for decreased offset drift and improved displacement accuracy. The methods also provide for the ability to determine parameters relating to the quality of the compression/decompression cycle by morphological analysis of the acceleration and velocity waveform. Multiple parameters may be determined via

the analysis and then combined in making a decision regarding chest release or other generalized descriptor of compression/decompression quality. The methods used may include standard decision logic (e.g., IF-THEN-ELSE) or may involve methods such as fuzzy-logic decision methodology or statistical estimation such as Bayesian methods.

[0021] Direct physiological measurements of perfusion and oxygenation, such as end-tidal carbon dioxide (EtCO₂) and pulse oximetry, can provide additional feedback to the CPR control algorithm.

[0022] By determining chest compliance, some implementations of the invention overcome the difficulty of using a pressure/force sensor for determining the onset and release of compression. The compliance of the thoracic cage varies from person to person, and therefore each individual will generally be able to support different amounts of force on the sternum without any displacement occurring. In some implementations of the invention, compliance is estimated from measurements of force (or pressure) and chest motion during compressions. The estimated compliance can be used to adapt the chest-released force threshold to patients with differing chest compliance. Without adapting the threshold to the victim's chest compliance, the chest-released force threshold tends to have to be set quite low, to assure substantial release even on patients with large compliance. This can result in requiring the rescuer to release nearly all force from the chest, interfering with the process of CPR itself and confusing the rescuer with what appears to be irrelevant and interfering commands.

[0023] Using a velocity sensor (as proposed with some aspects of the invention), can provide a more accurate and less noise sensitive measure for determining displacement. It requires only one integration to calculate displacement from velocity, thus reducing offset error, and it requires only one differentiation to calculate acceleration thus reducing high frequency noise susceptibility. Additionally, velocity in this implementation is a differential configuration that measures relative velocity between the front and back of the thorax, unlike acceleration which is inertial and whose motion is relative to the Earth. Differential velocity measurement provides a significantly improved performance during patient transport such as in an ambulance or on an airplane. In fact, the vibration and motion may make the acceleration for the most part unusable in these situations.

[0024] Magnetic induction may be used to generate a voltage proportional to the relative velocity between a magnet and coil. The magnet may take the form of a permanent magnet, but preferably it is an electromagnet. The use of an electromagnet serves two main purposes: it can be used to calibrate the setup after the electrodes have been applied to the patient, and it can be used to provide a synchronous modulation/demodulation of the signal to improve accuracy and minimize susceptibility to noise and artifact.

[0025] The magnetic pickup and induction coils may be incorporated into defibrillation pads. One defibrillation pad can be placed on the left thorax and another defibrillation pad can be placed on the victim's back in the left scapular area. These are excellent locations for defibrillation and provide a good placement to generate magnetic flux changes proportional to sternal displacement. The coils can be incorporated directly into the outer edge of each of the defibrillation electrodes. Alternatively, if the desired electrode position is anterior/anterior with both electrodes on the front of the chest, a separate backboard panel may be supplied which is placed under the patient and contains the receiving coil.

[0026] The invention's use of velocity sensor, which may make it possible to perform ECG analysis without a "hands off" period provides improved filtering and rhythm analysis.

[0027] Other features and advantages of the invention will be apparent from the following detailed description and drawings, and from the claims.

DESCRIPTION OF DRAWINGS

[0028]

FIG 1 is a diagram of one implementation including an AED and an accelerometer and pressure/force sensor built into a chest-mounted pad.

FIG 2 shows sample signals recorded during CPR with the implementation of FIG 1.

FIG 3 is a diagram of another implementation including an AED with a membrane switch and an accelerometer.

FIG 4 shows sample signals recorded during CPR with the implementation of FIG 3.

FIG 5 depicts acceleration, velocity, and displacement for a single compression cycle.

FIG 6 is a block diagram of another implementation.

FIG 7 depicts acceleration, velocity, and displacement for two compression cycles.

FIGS. 8, 9A, and 9B show an implementation in which magnetic induction elements are built into electrodes placed in anterior and posterior locations on the thorax.

FIG 10 is an enlarged view of the composition of the electrode pad of FIGS. 9A.

FIG 11 is a block diagram of a synchronous detector implementation.

FIG. 12 is a block diagram of a filtered-X least mean squares (FXLMS ANC) algorithm.

FIG 13 is an implementation using the algorithm of FIG 12.

FIG 14 shows two spectral power distributions related to the implementation of FIG 13.

FIG 15 is a block diagram of another implementation.

DETAILED DESCRIPTION

5 **[0029]** There are a great many possible implementations of the invention, too many to describe herein. Some possible implementations that are presently preferred are described below. It cannot be emphasized too strongly, however, that these are descriptions of implementations of the invention, and not descriptions of the invention, which is not limited to the detailed implementations described in this section but is described in broader terms in the claims.

10 **[0030]** FIG. 1 shows a schematic of a preferred implementation. This implementation includes an accelerometer (and accelerometer housing), force sensor built into a pressure pad, and an AED which is electrically connected to the accelerometer and force sensor and contains a display and/or speaker for user feedback. The pressure pad provides the structural member on which the accelerometer (and housing) is supported. Neither the accelerometer nor force sensor of the pad are essential to detecting chest release, as other sensors can be used. The force sensor can measure force or pressure.

15 **[0031]** The accelerometer housing can be shaped similar to a hockey puck and can rest either directly on the patient's sternum or on the pad or other structural member. Preferably the accelerometer is positioned to be over the victim's sternum in the position recommended for chest compressions. A force sensor can be placed below (as shown) or above the accelerometer housing. The rescuer presses on the accelerometer housing (or pressure pad) to perform chest compressions. The accelerometer senses the motion of the chest during CPR and the force sensor measures the force or pressure applied. The AED supplies power to the sensors and digitizes the electrical signals coming from the accelerometer and force sensor. Based on previous calibrations of the sensors, the accelerometer signal is integrated to determine the housing displacement, and the output of the force sensor is converted to standard pressure or force units.

20 **[0032]** FIG. 2 shows a sample drawing of the signals recorded during CPR using the implementation of FIG. 1. The acceleration signal is band pass filtered and integrated to derive displacement information (e.g., a displacement signal). Compressions (C1-C5) can be detected from the displacement signal. The compression rate is calculated from the interval between compressions (e.g. (time of C2 - time of C1)), and compression depth is measured from the compression onset to peak displacement (e.g. (d1 - d0)). The onset and peak compression values are saved for each compression. The pressures at the compression onset and offset are used to determine the force used to achieve a given compression depth. The compliance of the chest can be estimated from the compression displacement and the related compression pressure. The pressure "p0" is the reference pressure prior to the start of CPR and is related to the resting chest displacement "d0". The pressure "p1" is the pressure required to achieve the displacement "d1". The chest compliance is estimated from the following equation:

$$35 \quad \text{Chest Compliance} = \{(d1 - d0) / (p1 - p0)\}$$

40 **[0033]** Where d1 is the displacement at the peak of the compression, d0 is the displacement at the onset of the compression, p1 is the pressure at the peak of the compression, and p0 is the pressure at the onset of the compression. The chest compliance can be calculated for each compression and averaged to improve the measurement accuracy.

[0034] Once the patient specific chest compliance is known, it can be used to estimate the absolute displacement of the puck when combined with the instantaneous puck pressure measure from the following equation:

$$45 \quad \text{Displacement} = \text{compliance} * (p - p0)$$

50 **[0035]** Where p is the pressure measured from the puck at a point in time, p0 is the resting puck pressure when there is no compressions or handling by the rescuer. Therefore, the chest release displacement can be estimated by the following equation:

$$55 \quad \text{Displacement at the release of chest} = \text{compliance} * (p3 - p0).$$

[0036] Where compliance is determined as described above, p3 is the chest release pressure (estimated as the onset pressure of the next compression), and p0 is the resting pressure.

[0037] The chest release pressure can alternately be measured as the minimum pressure point between the two compressions.

[0038] The chest release displacement point is compared to a pre-defined threshold level to determine if the chest was substantially released between two compressions (i.e., released sufficiently to create a pressure in the chest that facilitates venous filling of the heart). A combination of voice prompts and display messages can be used to tell the rescuer to more completely release the chest between compressions if the chest release displacement point does not return below the set threshold. The chest release displacement value can be averaged to improve the estimate accuracy. The comparison to the threshold level could also be done via "voting" logic such as the last x out of y values exceed the set threshold and trigger the release of chest feedback. The CPR release of chest algorithm continually runs while the rescuer performs CPR and provides immediate feedback if the rescuer does not release the chest at any time during the resuscitation.

[0039] Although not necessary, the threshold level is preferably adjusted dynamically as a function of the calculated chest compliance. For patients with a lower compliance, the threshold can be increased since increased force will have little or no effect on displacement. For patients with higher compliance, the threshold may need to be decreased.

[0040] The calculated estimate of chest compliance can also be used with the output of the force sensor to estimate the depth of chest compression. Thus, for example, the output of the accelerometer could be used with the output of the force sensor during an initial time interval to calculate an estimate of chest compliance. Thereafter, the estimated chest compliance could be used to convert the force measurement into an estimated depth of chest compression.

[0041] FIG. 3 shows another implementation wherein the force sensor is replaced with a mechanical or electrical switch. The rescuer performs CPR by pressing on the switch/housing assembly. The switch is activated based on the forces used with CPR compressions and deactivated when a compression is released. The switch may provide for bistable positional states such as in a domed switch that when depressed would provide tactile feedback to the hand of the rescuer upon the start of the compression (dome collapse) and at the end of compression (dome return). The switch vibration associated with the transition between the two states may also be sufficient to provide an audible feedback to the rescuer as well. If the compression release vibration is heard and/or felt, the chest can be considered by the rescuer to have been released.

[0042] FIG. 4 shows the acceleration, derived displacement, and switch output signals during a sample of CPR. Each compression is identified at the top of the diagram (C1-C5). The compression interval, rate, and depth are measured from the acceleration signal. The dashed line overlaying the switch output curve indicated the force on the puck assembly and is drawn to show the actuation of the switch when the force curve exceeds that activation threshold (solid straight line). Time t1 shows the actuation of the switch and time t2 shows the release of the switch. On the third compression (C3), the compression switches (ON) at time t3, but does not switch off at time t4 because the force on the chest does not go below the trigger threshold. The acceleration signal shows that chest compressions are continuing, but the switch indicates that the chest is not being substantially released. When chest release is not occurring, the AED can audibly and/or visually prompt the user to release the chest.

[0043] In another implementation, the acceleration waveform alone is analyzed without the use of a switch or force sensor. FIG. 5 depicts the acceleration, velocity and displacement for a single compression/decompression cycle. The input signal from the acceleration sensor, as shown in the block diagram in FIG. 6, is conditioned and filtered to minimized artifact and noise and is input to an A/D converter. The A/D converter is then read by the microprocessor. In FIG. 5, the points of interest in the acceleration waveform are as follows:

1. A0 is the point of maximum acceleration during the compression downstroke.
2. A-2 is the compensatory small upstroke that rescuers often do just prior to the initiation of the compression downstroke and marks the initiation point of the compression downstroke.
3. A-1 is the point of maximum acceleration of the compression downstroke.
4. A1 is the point of maximum deceleration on the decompression upstroke.
5. A2 is a small upward release when the rescuer's hands are slightly lifted from the patient's sternum during an optimum compression cycle.
6. A-3 and A3 are inflection points where the signal deviates from baseline.
7. SA0 and SA1 are the slopes of the acceleration of the line segments on each side of A0.
8. SVO and SV1 are the slopes of the line segments (~ acceleration) as shown on the velocity curve.
9. VMax is the maximum velocity achieved during the compression downstroke.

[0044] Many algorithms can be used for determination of substantial release of the chest One algorithm is as follows:

1. Determine fiducial point A0. Completion of the compression determination should approach real time in order to provide maximum benefit to the rescuer. Delays of approximately 1-4 seconds are acceptable and will limit the types of 'search forward' algorithms that can be implemented. A0 can be detected by a number of means. One method

EP 2 301 509 A1

is to band pass filter the acceleration signal to produce maximum output signal amplitude of signals having a slope most closely approximating those observed in real compression signals. The band pass output is then input to a threshold detection function. If the signal amplitude is larger than the threshold, then SA0 has been detected. The threshold itself may be dynamically adjusted in amplitude to minimize susceptibility to noise and interference. For instance, if out of band noise such as 60 Hz interference is detected, then the threshold may be increased. The threshold may also be gradually lowered following an SA0 detection such that the probability of detection is increased for signals that occur at the expected interval and is decreasing for false signals that may occur immediately subsequent to the detection. Once SA0 has been detected, the algorithm can search forward until it finds the peak amplitude, A0.

2. Searching backwards and forwards from point A0, the points A-3, A-2, A-1, A0, A1, A2 and A3 can be determined.
3. The acceleration signal can then be decomposed into constituent triangles formed from these fiducial points. TriangleA0 refers to the triangle formed by the A-1, A0 and A1 fiducial points (in gray in FIG. 5).

4. The triangles are then parameterized using Such morphological characteristics as width, amplitude, area, center of mass, skewness, height/width ratio, etc.

5. Area ratios are then calculated for the various triangle pairs. For example the ratio of the areas of TriangleA0 and TriangleA1, Acceleration Triangular Area Ratio(0,1) [TARA(0,1)]

$$\text{TARA}(0,1) = [\text{Area TriangleA0}] / [\text{Area of TriangleA1}]$$

6. Amplitude ratios are then calculated for the various triangle pairs. Degree of skew is incorporated into the amplitude calculation by incorporating either skewness or center of mass into the calculation for each triangle. For example the ratio of the areas of TriangleA0 and TriangleA1, Triangular Amplitude ratioA(0,1) (TAMPRA(0,1))

$$\text{TAMPRA}(0,1) = [\text{Amplitude of TriangleA0}] / [\text{Amplitude of TriangleA1}]$$

7. The same process is repeated for the triangular width ratio (TWR).

8. A rescuer who applies too much downward force during the decompression upstroke will cause incomplete decompression. This downward force opposes the natural elastic force of the thoracic cage and as a result causes a decreased amplitude and elongation of triangleA1 and triangleA2 as shown in FIG. 7.

9. The acceleration signal is integrated beginning at inflection point A-3 and ending just subsequent to A3 in order to calculate the velocity. The same analysis is used to calculate the fiducial points V-2, VMax, V0 and V1, as well as TAR, TAMPR and TWRs for the velocity curve.

10. The velocity curve segment is integrated a second time to calculate displacement.

Displacement values D-3 and D3 and DMax are calculated. Differential displacement, $\Delta D = D-3 - D3$ is calculated.

11. Based on DMax, the device can prompt the rescuer if the depth of compressions are not sufficient.

12. Based on VMax, the user can be prompted to deliver a 'sharper' more rapid pulse to improve hemodynamics.

13. End tidal carbon dioxide (EtCO2) measurements are taken during the course of CPR. Visual and/or audible prompting from the device can encourage the rescuer to increase rate and depth of compressions to improve hemodynamics.

14. The calculated parameters of width, amplitude, area, center of mass, skewness, height/width ratio, TAR, TAMPR and TWR for both the acceleration and the velocity as well as ΔD are used to make a decision on whether the chest was released. The methods used may be standard decision logic (IF-THEN-ELSE) or may involve methods such as fuzzy-logic decision methodology or statistical estimation such as Bayesian methods. In general, ΔD alone would not be used to determine chest release, but nonetheless the signal processing methods have made it possible with this method to be able to measure ΔD without the use of switches or force sensors.

15. Final determination of compression release can be withheld for a number of compression cycles to measure longer term trending of the parameters. For example, the rescuer may have momentarily had to pause to wipe their brow.

[0045] Alternatively, other signal detection and classification methods known to those skilled in the art may be used to determine the relevant morphological features such as those shown in FIG. 7 (CPR with substantial chest release is shown by solid lines; inadequate chest release, by dashed line).

[0046] In another implementation, a velocity sensor is used to determine the motion parameters. One of many possible

techniques for sensing velocity is to use magnetic induction to generate a voltage proportional to the relative velocity between a magnet and coil. The configuration is shown in FIG. 8. The magnet may take the form of a permanent magnet, but preferably it is an electromagnet. As shown in FIG. 9A and 9B, a defibrillation pad is placed on the left thorax and another defibrillation pad is placed on the victim's back in the left scapular area. These are optimal locations for defibrillation and provide a good placement to generate magnetic flux changes proportional to sternal displacement. The coils are incorporated directly into the outer edge of each of the defibrillation electrodes. Alternatively, if the desired electrode position is anterior/anterior with both electrodes on the front of the chest, a separate backboard panel may be supplied which is placed under the patient and contains the receiving coil. The use of an electromagnet serves two main purposes: it can be used to calibrate the setup after the electrodes have been applied to the patient and they can be used to provide a synchronous modulation/demodulation of the signal to improve accuracy and minimize susceptibility to noise and artifact.

[0047] The defibrillation electrodes can be constructed with a conventional configuration. An electrically conductive sheet of material that delivers defibrillation current to the patient is backed with an insulating thin foam material, and a slightly adhesive conductive gel coupling agent adheres the conductive sheet to the patient's skin. The foam backing also forms an approximately 0.5 to 1.0 inch border around the active conductive area. The magnetic coil element can be added onto the foam backing and becomes part of the border area, as shown in FIG. 10.

[0048] The device (e.g., AED) can be provided with circuitry for determining whether or not the electrodes have been properly applied to the patient. The method currently employed by most manufacturers of defibrillators is to use a small amplitude, high frequency signal (~2 microamps, 60 KHz) to measure impedance. The electrodes are determined to be applied when the impedance falls into the physiologic range.

[0049] When the device has detected the application of the electrodes, the device can prompt the rescuer to stand clear. At this time, the device will perform calibration of the velocity sensor. A time-varying signal, typically a ramp or sine wave of several frequencies of interest, such as the modulation frequency, is applied to the electromagnet and the signal is measured at the receiving coil. From this, gain and offset coefficient can be calculated for use during the CPR event. This calibration step allows for improved accuracy with patients of varying chest sizes and in the presence of any nearby magnetically conductive surfaces or objects.

[0050] Preferably, a synchronous detector can be employed to minimize susceptibility to noise and artifact as shown in the block diagram in FIG. 11. A sine wave carrier frequency of 500 Hz or more is supplied to the electromagnet coil to generate an oscillating magnetic field that, in turn, induces a voltage on the receiving coil. Chest compressions vary the field intensity at the receiving coil, thus causing an amplitude modulation of the carrier. As can be seen in FIG. 11, a band pass filter immediately subsequent to signal reception reduces interference outside the range of the carrier frequency such as AC magnetic interference. The phase lock loop (PLL) is used for carrier regeneration, but since the transmitter and receiver are in the same device, the transmission carrier can be used for detection as well, as long as circuitry is provided for phase adjustment of the demodulation signal. Multiplexer S1, combined with the demodulation signal, causes rectification of the signal, which can then be low pass filtered to recover the compression velocity waveform. Alternatively, a synchronous AM demodulator can be employed with an analog multiplier stage.

[0051] In another implementation, the velocity signal may then be used to reduce artifacts in the ECG signal. This is accomplished by first time-aligning the ECG and velocity signal by such methods as cross-correlation techniques known to those skilled in the art. This will provide alignment of the two signals relative to the compressions. Then, preferably, adaptive filtering methods are used such as those involved in the minimization of the mean-squared error between the ECG and the velocity.

[0052] In a further implementation, more sophisticated signal processing methods may be used to minimize ECG artifacts induced by CPR chest compressions. For example, methods known as feed forward active noise cancellation (FANC) may be used. FIG. 12 shows a block diagram of the filtered-X least mean squares (FXLMS ANC) algorithm, as developed by Widrow and Burgess. $P(z)$ represents the unknown plant through which the signal $x(n)$ is filtered. Digital filter $W(z)$ is adaptively adjusted to minimize the error signal $e(n)$. In one implementation, as depicted in FIG. 13, $x(n)$ is the unfiltered ECG signal, $P(z)$ is eliminated from the diagram, and $d(n)$ is approximated with the chest compression velocity signal $v(n)$. In the LMS algorithm, assuming a mean square cost function $\xi(n) = E[e^2(n)]$, the adaptive filter minimizes the instantaneous squared error, $\xi(n) = e^2(n)$, using the steepest descent algorithm, which updates the coefficient vector in the negative gradient direction with step size μ :

$$\mathbf{w}(n+1) = \mathbf{w}(n) - \mu/2 * \tilde{\mathbf{N}} \xi(n),$$

where $\tilde{\mathbf{N}}\xi(n)$ is an instantaneous estimate of the mean square error (MSE) gradient at time n equal to $-2v(n) e(n)$. Stability and accuracy of the FXLMS ANC algorithm by adding a variable cutoff low pass filter $H(z)$ to eliminate frequency components in the ECG not related to the chest compression artifact. In general, the spectral energy of the chest

compression artifact is predominately lower than those of the ECG. A cutoff frequency of approximately 3 Hz is adequate in many cases, but this may vary from patient to patient and among different rescuers performing chest compressions. To overcome this difficulty, an FFT is performed on $v(n)$ and input into a cutoff frequency estimation (CFE) procedure that determines the optimal cutoff frequency, f_C , for the lowpass filter. In a preferred implementation, the decision is based on calculating the frequency, not to exceed 5Hz, below which 80% of the waveform energy is present, but this percentage may vary and additional decision logic may be employed. For instance, an FFT may also be calculated for $x(n)$, also input to the CFE procedure. By first normalizing amplitude of the frequency spectra $X(z)$ amplitude peak of the compression artifact and then subtracting the velocity spectra $V(z)$ from the normalized input $X'(z)$, the difference spectra is calculated $\Delta X'(z) = X'(z) - V'(z)$. Frequencies are then determined for $V(z)$ and $\Delta X'(z)$ at which most of the spectral energy is within, set in this embodiment to 97%, and labeled f_{CV} and f_{CX} , respectively, and shown in FIG 14. f_C is then set to the lesser of f_{GV} and f_{CX} . Alternatively, f_C can be set to some intermediate frequency between f_{CV} and f_{CX} .

[0053] A simpler though related implementation is shown in FIG. 15, in which the CFE procedure is used to calculate the cutoff frequency for a high pass filter. Using the same methods as described in the previous paragraph, an FFT is performed on $v(n)$ and input into a cutoff frequency estimation (CFE) procedure that determines the optimal cutoff frequency, f_C , for, in this case, a high pass filter. In the preferred embodiment, the decision is based on calculating the frequency, not to exceed 5 Hz, below which 80% of the waveform energy is present, but this percentage may vary and additional decision logic may be employed. An FFT may also be calculated for $x(n)$, and also input to the CFE procedure and the optimal high pass cutoff frequency can be determined by the methods described in the previous paragraph. For instances when the spectral energy of the compression artifact is distinct from the ECG signal, this method will have a performance equivalent to the FXLMS just described; its performance will be somewhat inferior when the spectra of the ECG and compression artifact overlap, however.

[0054] Many other implementations of the invention other than those described above are within the invention, which is defined by the following claims. For example, it is not necessary that the invention include an external defibrillator, as a device for assisting delivery of CPR could be provided without defibrillation capability. The CPR assistance device could even be a pocket device that is for assisting with manual delivery of CPR.

[0055] Features of the one aspect of the invention may not be required in implementations of other aspects of the invention. For example, it is not necessary in some implementations of the invention that chest compliance be determined, or that substantial release of the chest be determined, or that a particular type of sensor (e.g., accelerometer, force sensor, velocity sensor), or combination of sensors, be used, or that there be analysis of features of a motion waveform, or that maximum velocity be estimated, or that artifacts in detected ECG signals be reduced.

[0056] Aspects of the invention may include any of the following.

1. Apparatus for assisting a rescuer in performing chest compressions during CPR on a victim, the apparatus comprising: a pad or other structure configured to be applied to the chest near or at the location at which the rescuer applies force to produce the chest compressions; at least one sensor connected to the pad, the sensor being configured to sense movement of the chest or force applied to the chest; processing circuitry for processing the output of the sensor to determine whether the rescuer is substantially releasing the chest following chest compressions; and at least one prompting element connected to the processing circuitry for providing the rescuer with information as to whether the chest is being substantially released following chest compressions.
2. The apparatus of aspect 1 wherein the pad or other structure is a pad to which force is applied by rescuer.
3. The apparatus of aspect 1 wherein the sensor includes an accelerometer.
4. The apparatus of aspect 1 wherein the sensor includes a force sensor.
5. The apparatus of aspect 1 wherein the sensor includes a velocity sensor.
6. The apparatus of aspect 1 wherein the sensor includes both a force sensor and an accelerometer or velocity sensor.
7. The apparatus of aspect 1 wherein the prompting device includes a speaker for delivering an audible message to the rescuer.
8. The apparatus of aspect 1 wherein the prompting device includes a display for delivering a visual message to the rescuer.
9. The apparatus of aspect 1 wherein the apparatus is part of an external defibrillator.
10. The apparatus of aspect 9 wherein the external defibrillator is an AED.
11. The apparatus of aspect 1 wherein the processing circuitry includes a digital processor executing software.
12. The apparatus of aspect 1 wherein determining whether the rescuer is substantially releasing the chest comprises analyzing motion of the chest.
13. The apparatus of aspect 12 wherein analyzing motion of the chest comprises analyzing features or the shape of a waveform representing chest motion.
14. The apparatus of aspect 1 comprising both a sensor to sense movement of the chest and a sensor to sense force applied to the chest, and wherein the processing circuitry uses outputs of both sensors to provide information

representative of chest compliance.

15. The apparatus of aspect 14 wherein the information representative of chest compliance is used to determine a level of applied pressure/force that corresponds to a substantial release of the chest.

5 16. Apparatus for assisting a rescuer in performing chest compressions during CPR on a victim, the apparatus comprising: a pad or other structure configured to be applied to the chest near or at the location at which the rescuer applies force to produce the chest compressions; and at least one velocity sensor connected to the pad, the velocity sensor being configured to sense the velocity of movement of the chest.

17. The apparatus of aspect 16 further comprising processing circuitry for processing the output of the velocity sensor to estimate the displacement of the chest.

10 18. The apparatus of aspect 17 wherein the processing circuitry has the capability to integrate an output of the velocity sensor.

19. The apparatus of aspect 16 or 29 wherein the velocity sensor is configured to be located approximately adjacent to the location at which the body is compressed.

15 20. The apparatus of aspect 16 or 29 wherein the velocity sensor is configured to be positioned to sense the relative velocity between opposite surfaces of the chest.

21. The apparatus of aspect 16 or 29 wherein the velocity sensor comprises a conductor and a magnet, and velocity is sensed by sensing the current induced in the conductor by relative motion between the conductor and the magnet.

22. The apparatus of aspect 21 wherein the magnet comprises one of a permanent magnet and an electromagnet.

23. The apparatus of aspect 21 wherein the conductor and magnet are positioned on opposite surfaces of the chest.

20 24. The apparatus of aspect 21 wherein the conductor comprises a coil that is unitary with a defibrillation electrode pad.

25. The apparatus of aspect 21 wherein the conductor and magnet each comprise a coil that is unitary with a defibrillation electrode pad.

26. The apparatus of aspect 16 or 29 wherein the magnet comprises an electromagnet and the electromagnet produces a magnetic field that oscillates at a frequency greater than 1 KHz, and further comprising coil detection circuitry to which the coil is connected, wherein the coil detection circuitry is capable of synchronously demodulating the detected signal to reduce susceptibility to drift and noise.

27. The apparatus of aspect 16 or 29 further comprising circuitry for acquiring ECG signals from the victim, and wherein the processing circuitry has the capability to process the output of the velocity sensor and the ECG signals to reduce ECG artifacts from chest compressions by use of velocity sensor output.

30 28. Apparatus for assisting a rescuer in performing chest compressions during CPR on a victim, the apparatus comprising: a pad or other structure configured to be applied to the chest near or at the location at which the rescuer applies force to produce the chest compressions; at least one motion sensor connected to the pad, the motion sensor being configured to sense movement of the chest; processing circuitry for processing the output of the motion sensor to estimate the maximum velocity of compression of the chest; and at least one prompting device connected to the processing circuitry for providing the rescuer with information representative of the maximum velocity of compression.

29. The apparatus of aspect 28 wherein the motion sensor comprises a velocity sensor.

40 30. A method of determining chest compression during CPR, the method comprising applying a motion sensor to the chest of a patient at a location near or at the location at which a rescuer applies force to produce chest compressions; determining chest displacement from analysis of features of the motion waveform produced by the motion sensor.

31. The method of aspect 30 wherein the motion sensor is a velocity sensor.

32. The method of aspect 30 wherein the motion sensor is an accelerometer.

45 33. The method of aspect 32 further comprising deciding from the analysis of features of the acceleration waveform whether or not a rescuer has sufficiently released the patient's chest.

34. The method of aspect 32 further comprising processing the output of the accelerometer to provide velocity and acceleration waveforms.

50 35. The method of aspect 33 further comprising processing the output of the accelerometer to provide velocity and acceleration waveforms, and analyzing the velocity and acceleration waveforms to determine whether or not a rescuer has sufficiently released the patient's chest.

36. The method of aspect 34 wherein the analysis of velocity waveforms includes determining the maximal velocity of compression.

37. The method of aspect 32 or 34 wherein determining chest displacement from analysis of features comprises determining onset and completion times for a compression cycle from the features of the waveforms.

55 38. The method of aspect 37 wherein determining chest displacement further comprises integrating the acceleration waveform over a time segment defined by the onset and completion times.

39. The method of aspect 32 or 34 further comprising analyzing the features of the upstroke portion of the waveforms to determine whether there has been sufficient release of the chest.

EP 2 301 509 A1

40. The method of aspect 32 or 34 further comprising prompting a rescuer based as to whether compressions are within desired limits on compression depth and compression release.

41. The method of aspect 40 wherein the prompts to the rescuer are based on multi-cycle trends, so that they are not immediately influenced by the rescuer taking a brief break in the application of CPR.

42. The method of aspect 40 further comprising determining chest compliance, and using the determined chest compliance to adjust the level of pressure/force that the rescuer is permitted to apply at the end of a compression stroke without being prompted as to insufficiently releasing the chest.

43. The method of aspect 34 wherein the features determined from the waveforms include one or more of the following: width, amplitude, area, center of mass, skewness, height/width ratio, TAR, TAMPR and TWR.

44. The method of aspect 43 wherein the features are used to make a decision as to whether the chest of the victim has been sufficiently released.

45. The method of aspect 44 wherein decisions are made using either standard decision logic, fuzzy-logic decision methodology, or statistical estimation.

46. A method of analyzing ECG signals during application of CPR, the method comprising: detecting ECG signals during application of chest compressions; detecting the output of a sensor from which information on the velocity of chest compressions can be determined; and using the information on the velocity to reduce at least one signal artifact in the ECG signal resulting from the chest compressions.

47. The method of aspect 46 wherein the sensor is a velocity sensor, and the information on the velocity is determined from the velocity sensor.

48. The method of aspect 46 wherein the sensor is an accelerometer, and the information on the velocity is determined from integration of the output of the accelerometer.

49. The method of aspect 46 wherein using the information on the velocity to reduce at least one signal artifact in the ECG signal comprises time aligning the ECG signals with the velocity.

50. The method of aspect 46 wherein using the information on the velocity to reduce at least one signal artifact in the ECG signal comprises an adaptive filter that is adjusted to remove chest compression artifacts.

51. The method of aspect 46 wherein using the information on the velocity to reduce at least one signal artifact in the ECG signal comprises feed forward active noise cancellation.

52. The method of aspect 46 wherein using the information on the velocity to reduce at least one signal artifact in the ECG signal comprises determining a cutoff frequency for a filter that separates the ECG signal from chest compression artifacts.

53. Apparatus for assisting a rescuer in performing chest compressions during CPR on a victim, the apparatus comprising: a pad or other structure configured to be applied to the chest near or at the location at which the rescuer applies force to produce the chest compressions; at least one motion sensor connected to the pad, the motion sensor being configured to sense movement of the chest; at least one force sensor connected to the pad, the force sensor being configured to sense force applied to the chest; and processing circuitry for processing the output of the motion sensor and force sensor to estimate the compliance of the chest.

54. The apparatus of aspect 53 wherein the estimated compliance and the output of the force sensor are used to determine the depth of compression of the chest.

55. The apparatus of aspect 54 wherein the motion sensor is an accelerometer, and the output of the accelerometer is used primarily for estimating chest compliance, and compression depth during CPR is estimated by using the estimated compliance to convert the output of the force sensor into estimated compression depth.

56. The apparatus of aspect 55 wherein the output of the accelerometer is used during limited time intervals for estimating chest compliance, and outside of those limited time intervals chest compression is determined from the estimated compliance and the output of the force sensor without substantial use of the output of the accelerometer.

57. The apparatus of aspect 53 or 54 wherein the estimated compliance and the output of the force sensor are used to determine whether the chest has been substantially released.

58. Apparatus for assisting a rescuer in performing chest compressions during CPR on a victim, the apparatus comprising: a pad or other structure configured to be applied to the chest near or at the location at which the rescuer applies force to produce the chest compressions; at least one bistable mechanical element that when depressed provides tactile feedback to the hand of the rescuer upon the start of a compression and at the end of a compression.

59. The apparatus of aspect 58 wherein the mechanical element comprises a dome that collapses under pressure and returns to a dome shape on release of pressure.

60. The apparatus of aspect 58 wherein the bistable mechanical element further provides audible feedback at least at the end of a compression.

61. The apparatus of aspect 58 wherein the tactile feedback at the end of a compression occurs at approximately an applied force corresponding to substantial release of the chest, so that the tactile feedback serves as feedback to the rescuer that the chest has been substantially released.

Claims

1. Apparatus for assisting a rescuer in performing chest compressions during CPR on a victim, the apparatus comprising:

a pad or other structure configured to be applied to the chest near or at the location at which the rescuer applies force to produce the chest compressions; and
at least one velocity sensor connected to the pad, the velocity sensor being configured to sense the velocity of movement of the chest.

2. The apparatus of claim 1 further comprising processing circuitry for processing the output of the velocity sensor to estimate the displacement of the chest.

3. The apparatus of claim 2 wherein the processing circuitry has the capability to integrate an output of the velocity sensor.

4. The apparatus of claim 1 wherein the velocity sensor is configured to be located approximately adjacent to the location at which the body is compressed.

5. The apparatus of claim 1 wherein the velocity sensor is configured to be positioned to sense the relative velocity between opposite surfaces of the chest.

6. The apparatus of claim 1 wherein the velocity sensor comprises a conductor and a magnet, and velocity is sensed by sensing the current induced in the conductor by relative motion between the conductor and the magnet.

7. The apparatus of claim 6 wherein the magnet comprises one of a permanent magnet and an electromagnet.

8. The apparatus of claim 6 wherein the conductor and magnet are positioned on opposite surfaces of the chest.

9. The apparatus of claim 6 wherein the conductor comprises a coil that is unitary with a defibrillation electrode pad.

10. The apparatus of claim 6 wherein the conductor and magnet each comprise a coil that is unitary with a defibrillation electrode pad.

11. The apparatus of claim 1 wherein the magnet comprises an electromagnet and the electromagnet produces a magnetic field that oscillates at a frequency greater than 1 kHz, and further comprising coil detection circuitry to which the coil is connected, wherein the coil detection circuitry is capable of synchronously demodulating the detected signal to reduce susceptibility to drift and noise.

12. The apparatus of claim 1 further comprising circuitry for acquiring ECG signals from the victim, and wherein the processing circuitry has the capability to process the output of the velocity sensor and the ECG signals to reduce ECG artifacts from chest compressions by use of velocity sensor output.

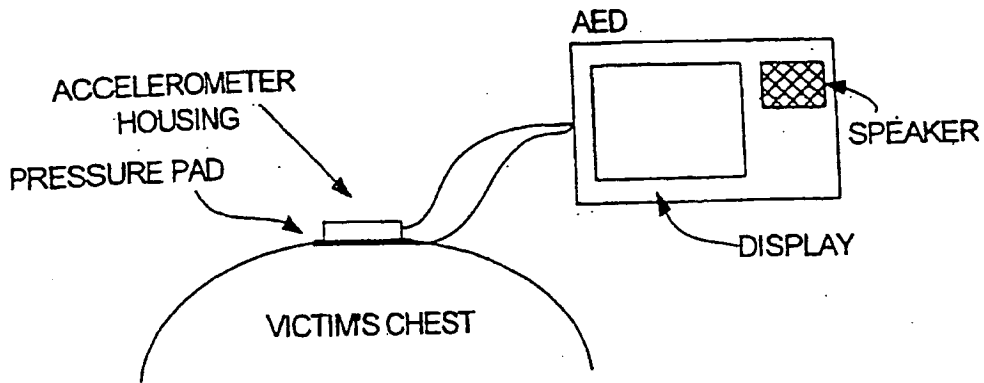

FIG. 1

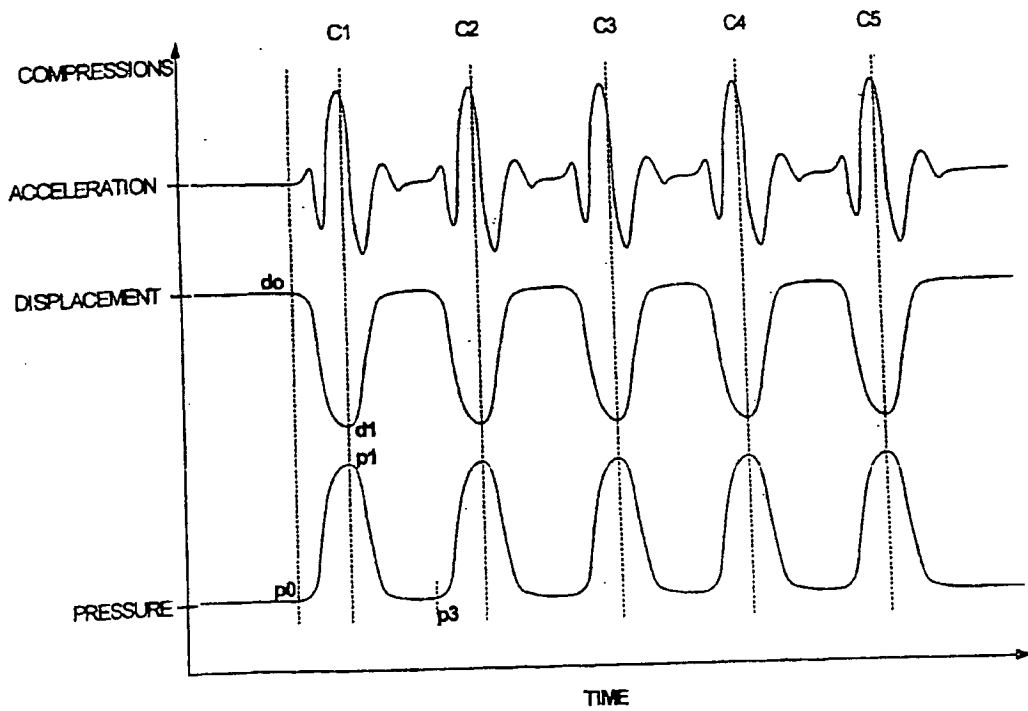

FIG. 2

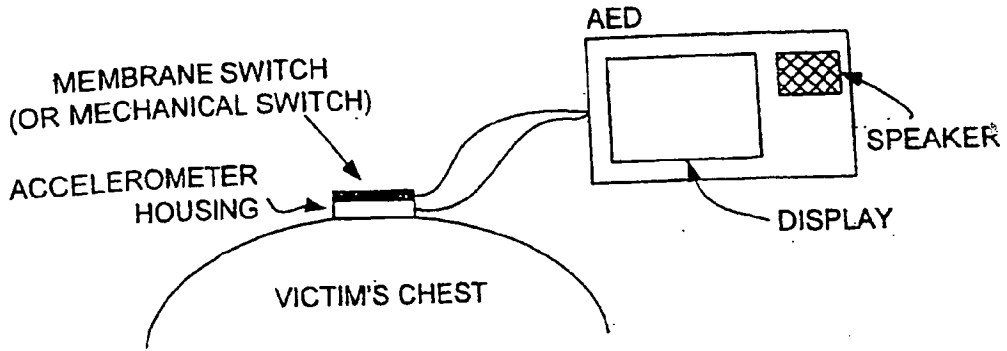

FIG. 3

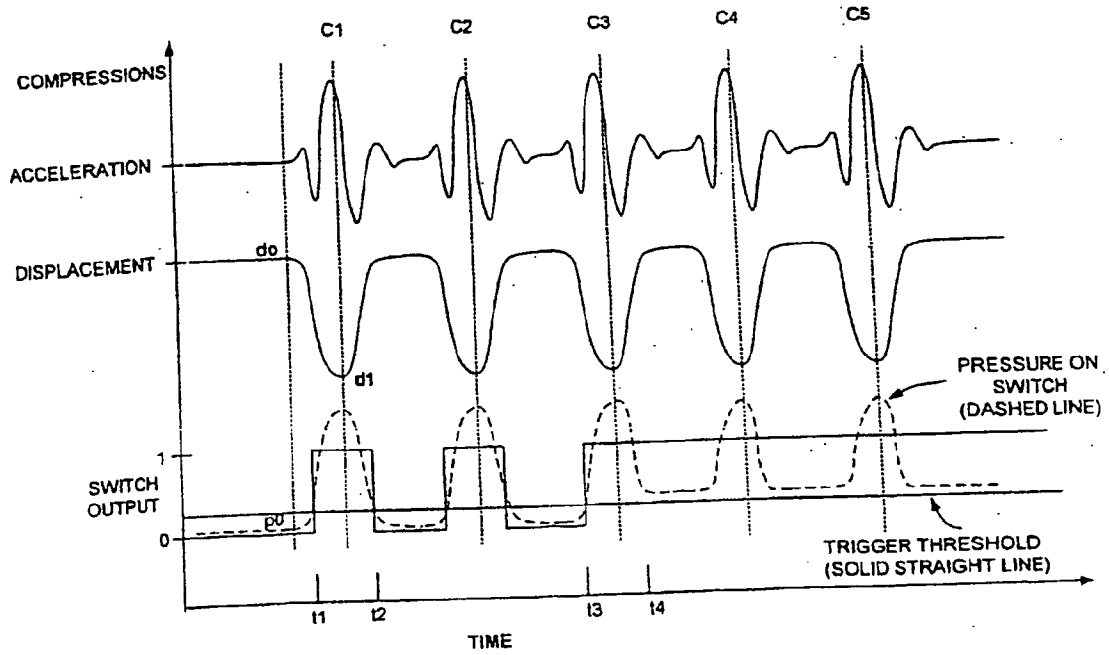
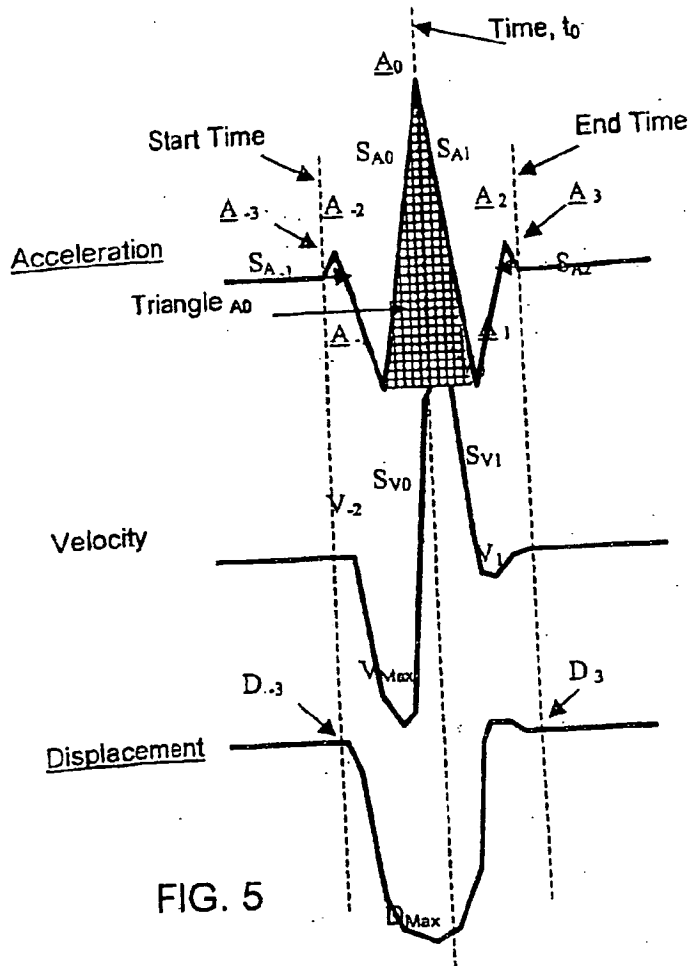

FIG. 4



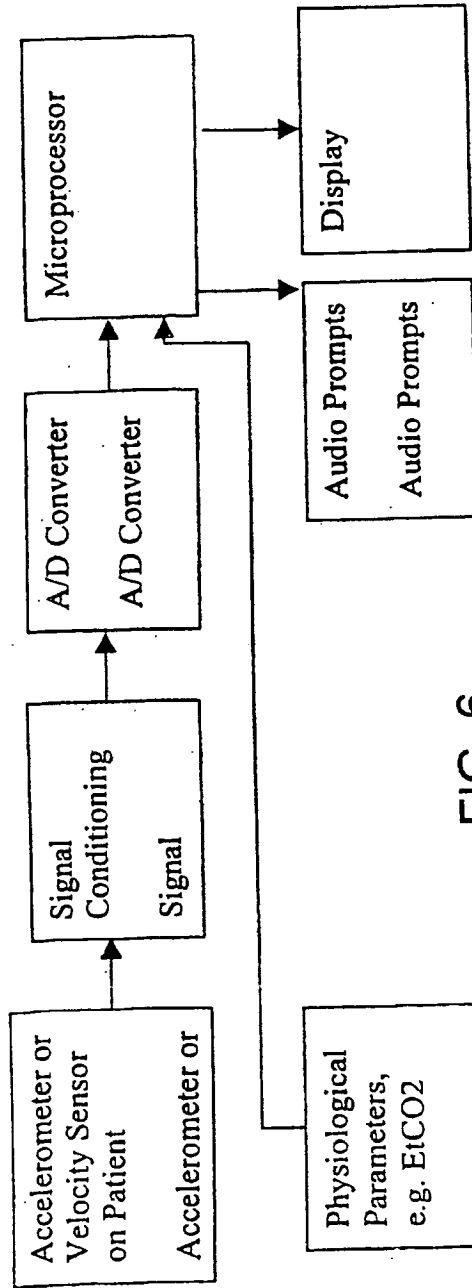

FIG. 6

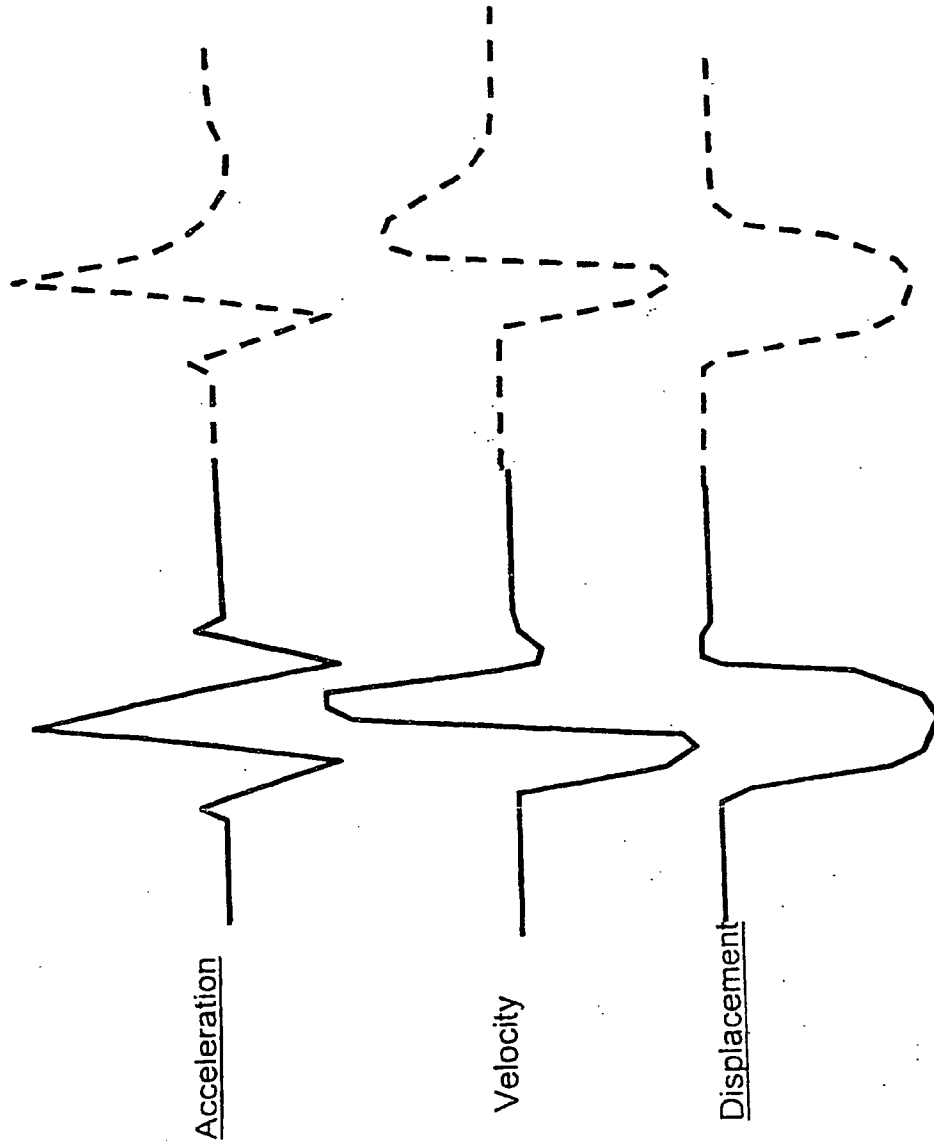

FIG. 7

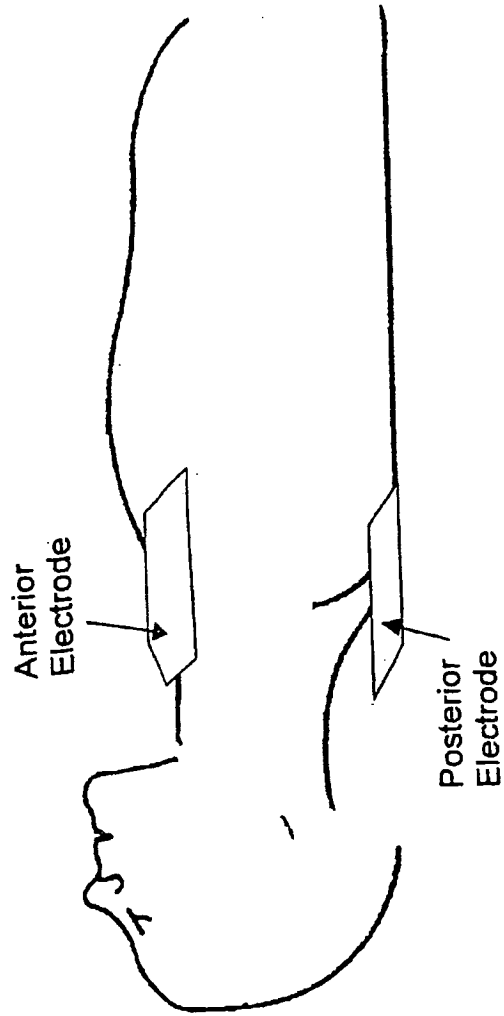

FIG. 8

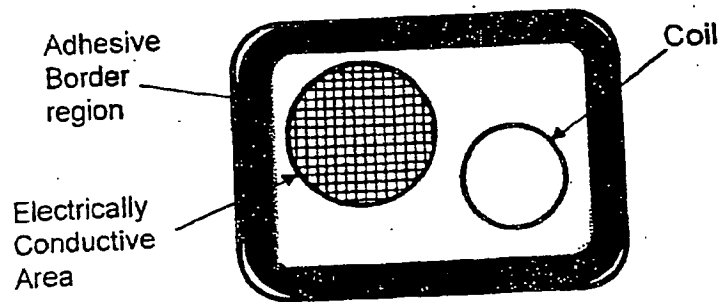
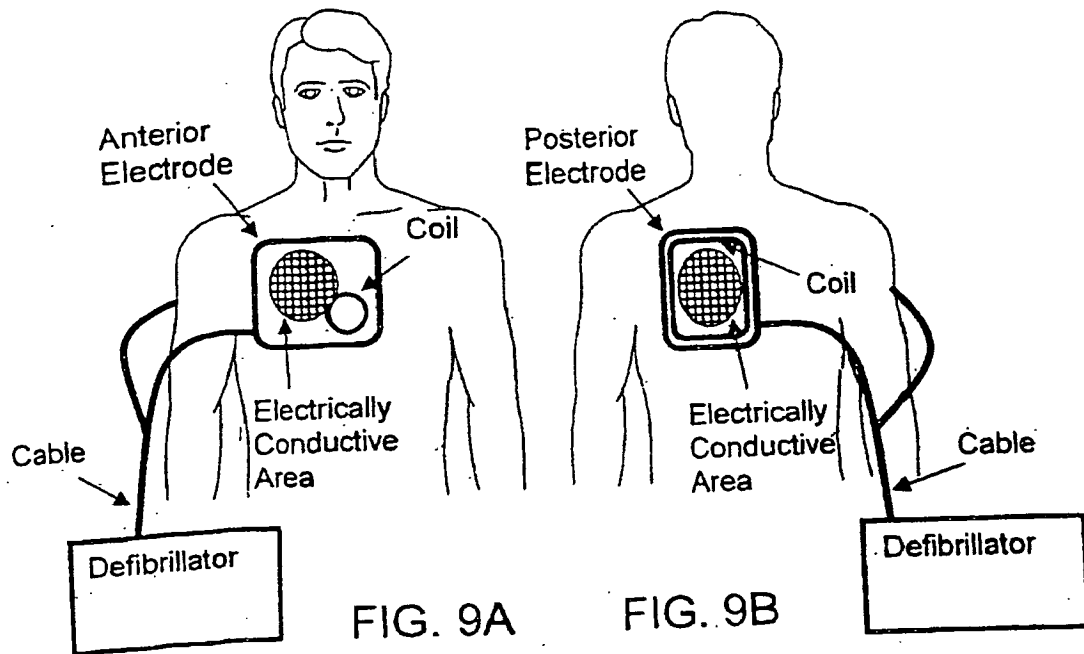

FIG. 10

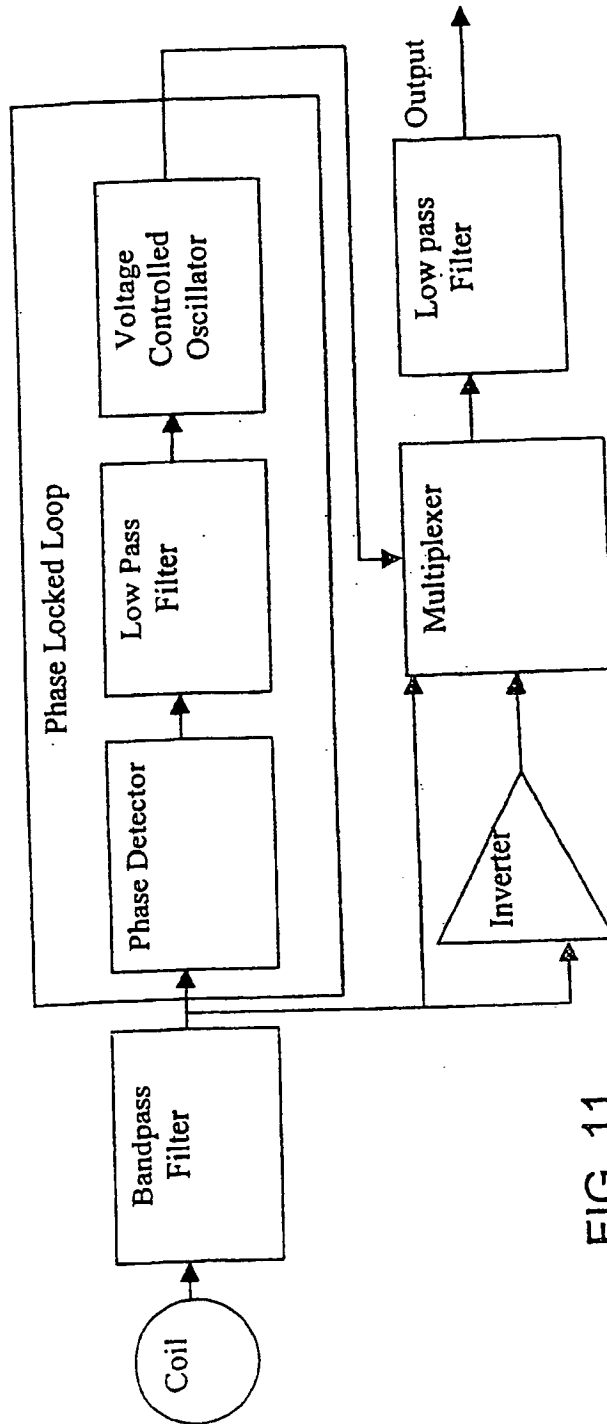

FIG. 11

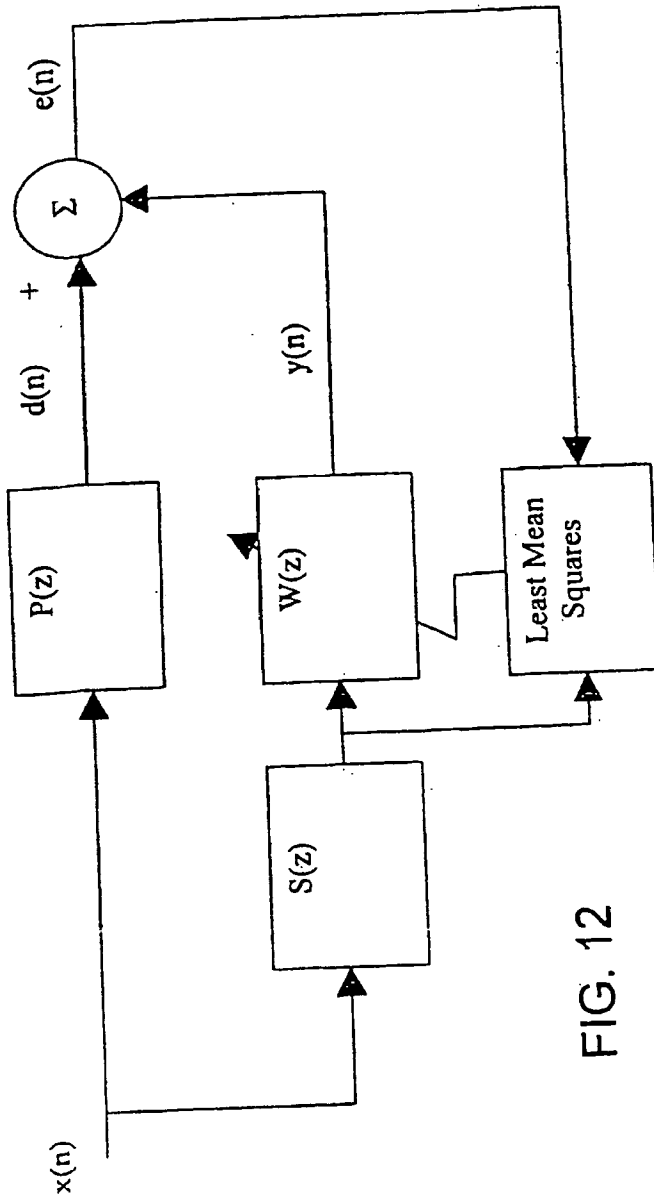

FIG. 12

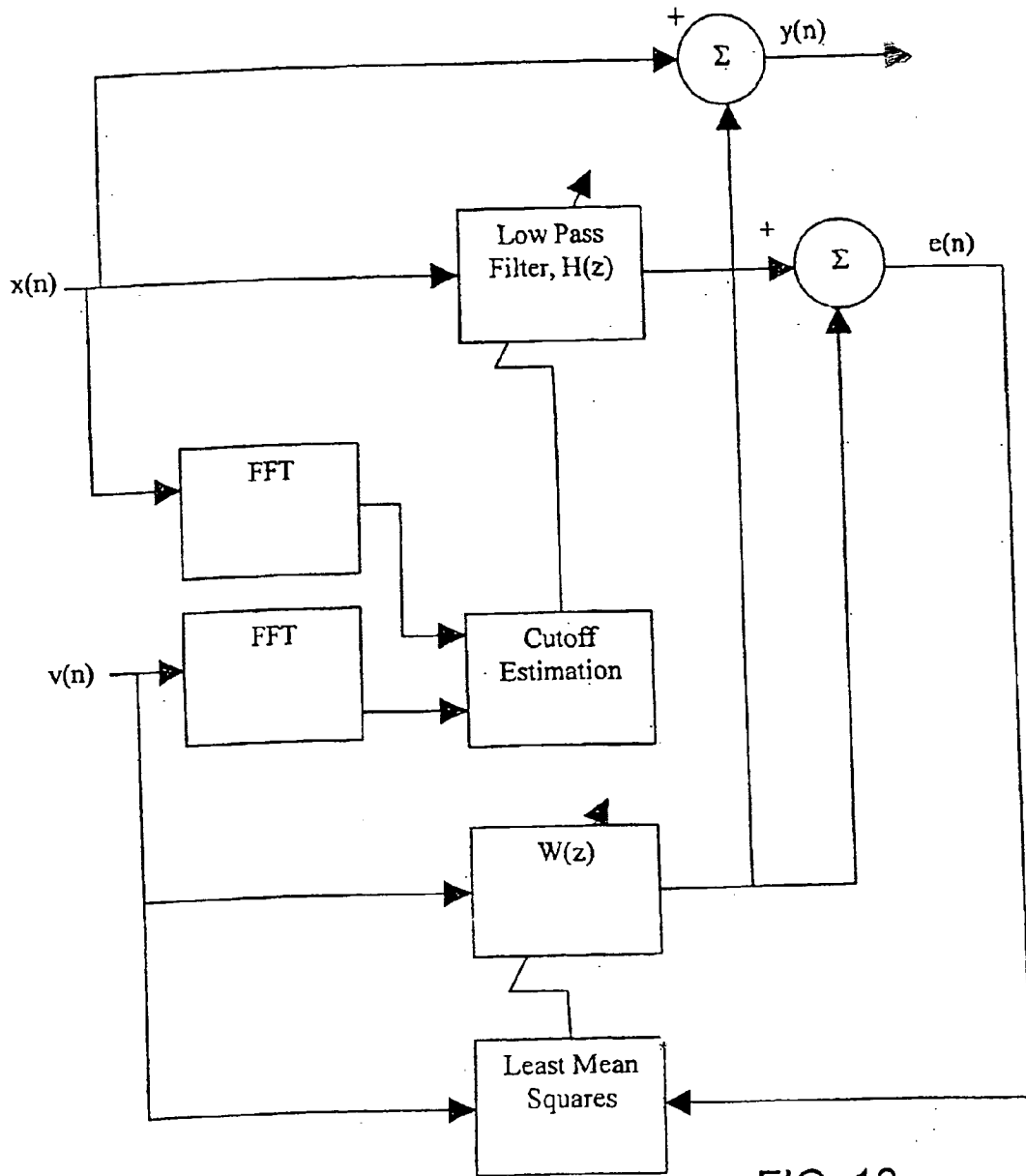

FIG. 13

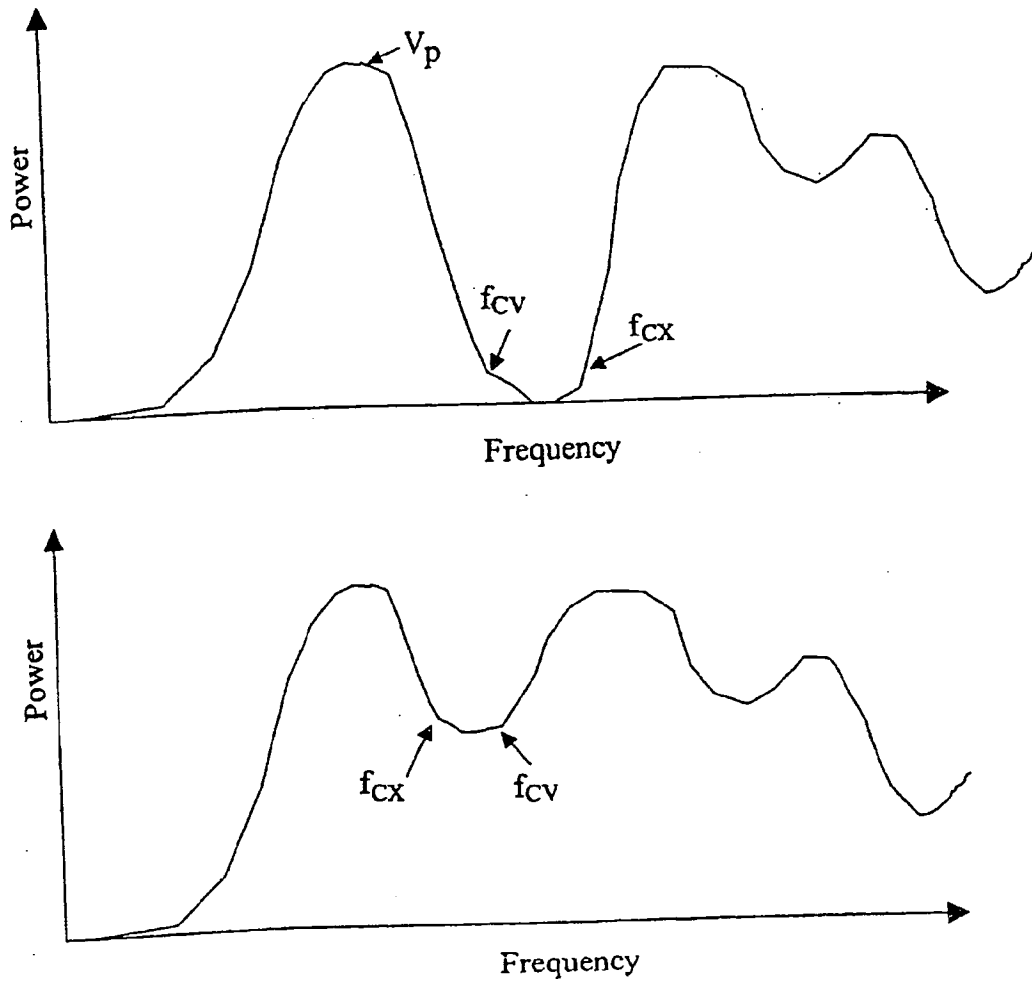

FIG. 14

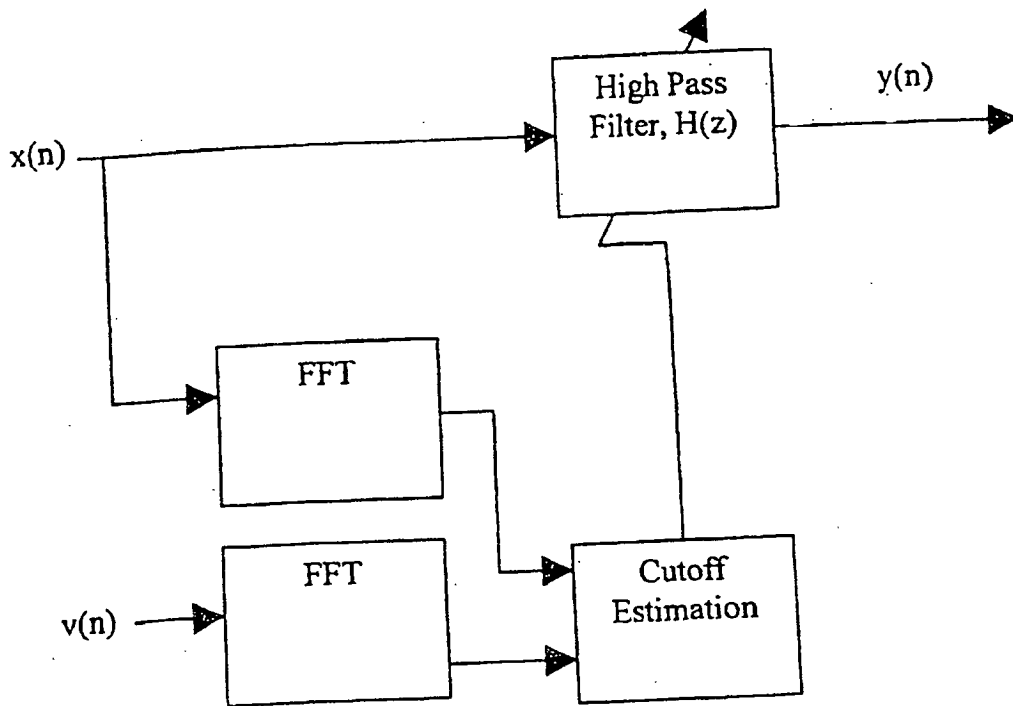

FIG. 15



EUROPEAN SEARCH REPORT

Application Number
EP 10 07 5412

DOCUMENTS CONSIDERED TO BE RELEVANT			
Category	Citation of document with indication, where appropriate, of relevant passages	Relevant to claim	CLASSIFICATION OF THE APPLICATION (IPC)
X	US 6 390 996 B1 (HALPERIN HENRY R [US] ET AL) 21 May 2002 (2002-05-21) * column 5, lines 32-54 * * column 6, line 50 - column 7, line 17 * * column 8, lines 20-30,46-56 * * column 11, lines 50-65 * * figures 3, 6, 7, 12 * -----	1-4,12	INV. A61H31/00 A61N1/39 G06F19/00
A	WO 02/15836 A (CPR DEVICES LTD ;GALILI NAFTALI (IL)) 28 February 2002 (2002-02-28) * page 8, line 10 - page 9, line 10 * * page 12, line 26 - page 14, line 13 * -----	1-4	
A	EP 1 057 451 A (LAERDAL MEDICAL AS) 6 December 2000 (2000-12-06) * abstract * * paragraphs [0009] - [0011] * * figures 1, 5, 6 * -----	1-4	
A	US 4 948 971 A (VOGEN WAYNE V [US] ET AL) 14 August 1990 (1990-08-14) * figure 3 * * column 5, lines 12-43 * * column 6, lines 22-43 * -----	5-11	TECHNICAL FIELDS SEARCHED (IPC) A61H A61N G06F G01L G01P
A	US 6 075 754 A (VANZANDT THOMAS R [US] ET AL) 13 June 2000 (2000-06-13) * abstract * * column 5, lines 21-35; figure 2 * -----	6-11	
The present search report has been drawn up for all claims			
Place of search Munich		Date of completion of the search 3 February 2011	Examiner Gärtner, Andreas
CATEGORY OF CITED DOCUMENTS X : particularly relevant if taken alone Y : particularly relevant if combined with another document of the same category A : technological background O : non-written disclosure P : intermediate document		T : theory or principle underlying the invention E : earlier patent document, but published on, or after the filing date D : document cited in the application L : document cited for other reasons & : member of the same patent family, corresponding document	

1
EPO FORM 1503 03.82 (P/MC01)

ANNEX TO THE EUROPEAN SEARCH REPORT
ON EUROPEAN PATENT APPLICATION NO.

EP 10 07 5412

This annex lists the patent family members relating to the patent documents cited in the above-mentioned European search report. The members are as contained in the European Patent Office EDP file on
The European Patent Office is in no way liable for these particulars which are merely given for the purpose of information.

03-02-2011

Patent document cited in search report	Publication date	Patent family member(s)	Publication date	
US 6390996	B1	21-05-2002	AU 2146500 A	29-05-2000
			EP 2275027 A2	19-01-2011
			EP 1128795 A2	05-09-2001
			JP 4566404 B2	20-10-2010
			JP 2002529157 T	10-09-2002
			JP 2009285475 A	10-12-2009
			US 2002165471 A1	07-11-2002
			WO 0027464 A2	18-05-2000
			US 2002193711 A1	19-12-2002
			US 2002055694 A1	09-05-2002
-----	-----	-----	-----	-----
WO 0215836	A	28-02-2002	AU 8247101 A	04-03-2002
-----	-----	-----	-----	-----
EP 1057451	A	06-12-2000	AT 429204 T	15-05-2009
			AU 762259 B2	19-06-2003
			AU 3261400 A	07-12-2000
			JP 2001037740 A	13-02-2001
			NO 992611 A	01-12-2000
			US 6306107 B1	23-10-2001
-----	-----	-----	-----	-----
US 4948971	A	14-08-1990	CA 2002735 A1	14-05-1990
			EP 0442966 A1	28-08-1991
			JP 6007472 B	26-01-1994
			JP 4504184 T	23-07-1992
			WO 9005991 A1	31-05-1990
-----	-----	-----	-----	-----
US 6075754	A	13-06-2000	NONE	
-----	-----	-----	-----	-----

REFERENCES CITED IN THE DESCRIPTION

This list of references cited by the applicant is for the reader's convenience only. It does not form part of the European patent document. Even though great care has been taken in compiling the references, errors or omissions cannot be excluded and the EPO disclaims all liability in this regard.

Patent documents cited in the description

- US 60900103 A [0001]
- US 794320 A, Freeman [0004]
- US 6306107 B [0004]
- US 6390996 B [0004]
- US 6125299 A, Groenke [0004]

专利名称(译)	用于在CPR期间增强胸部按压的方法和装置		
公开(公告)号	EP2301509A1	公开(公告)日	2011-03-30
申请号	EP2010075412	申请日	2004-06-23
[标]申请(专利权)人(译)	卓尔医学产品公司		
申请(专利权)人(译)	ZOLL医疗公司		
当前申请(专利权)人(译)	ZOLL医疗公司		
[标]发明人	GEHEB FREDERICK BOUCHER DONALD R FREEMAN GARY A		
发明人	GEHEB, FREDERICK BOUCHER, DONALD R FREEMAN, GARY A		
IPC分类号	A61H31/00 A61N1/39 G06F19/00 A61B5/0402 A61B5/00 A61B5/024 A61B5/0245 A61B5/11 A61B5/145 A62B9/00 A62B33/00		
CPC分类号	A61B5/024 A61B5/0402 A61B5/11 A61B5/1102 A61B5/145 A61B5/6823 A61B5/6833 A61B5/7455 A61B2562/0219 A61B2562/0247 A61H31/005 A61H31/007 A61H2031/002 A61H2201/5007 A61H2201/5043 A61H2201/5048 A61H2201/5061 A61H2201/5071 A61H2201/5079 A61H2201/5084 A61H2230/04 A61H2230/06 A61H2230/207 A61N1/39044 A61N1/3925 G16H15/00 G16H40/63 H01H2215/004		
优先权	10/609001 2003-06-27 US 10/704366 2003-11-06 US		
其他公开文献	EP2301509B1		
外部链接	Espacenet		

摘要(译)

一种用于辅助救助者在受害者的CPR期间执行胸部按压的装置，该装置包括垫或其他结构，该垫或其他结构被配置成施加到救护者施加力以产生胸部按压的位置附近或位置处的胸部，至少一个传感器连接到垫，传感器被配置为感测胸部的运动或施加到胸部的力，处理电路用于处理传感器的输出以确定救助者是否在胸部按压之后基本上释放胸部，并且至少一个提示元件连接到处理电路，用于向救助者提供关于胸部按压后胸部是否基本上被释放的信息。特别地，至少一个速度传感器连接到垫，速度传感器配置成感测胸部的运动速度。

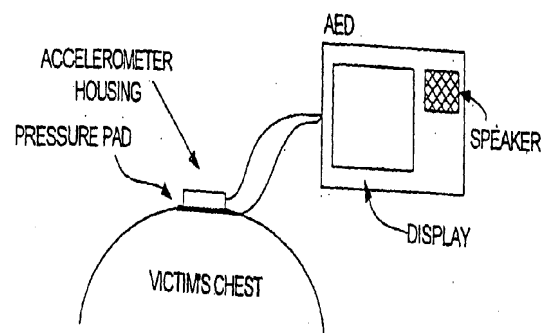

FIG. 1