



(51) International Patent Classification:

A61B 5/00 (2006.01) G06Q 50/24 (2012.01)
G06F 19/00 (2011.01)

TR), OAPI (BF, BJ, CF, CG, CI, CM, GA, GN, GQ, GW,
KM, ML, MR, NE, SN, TD, TG).

(21) International Application Number:

PCT/FI2016/050276

Published:

— with international search report (Art. 21(3))

(22) International Filing Date:

29 April 2016 (29.04.2016)

(25) Filing Language:

English

(26) Publication Language:

English

(71) Applicant: NOKIA TECHNOLOGIES OY [FI/FI];
Karaportti 3, 02610 Espoo (FI).

(72) Inventor: SAVOLAINEN, Teemu; Manttaalimutka 18 B
4, 37120 Nokia (FI).

(74) Agent: NOKIA TECHNOLOGIES OY et al.; Ari Aarnio,
IPR Department, Karakaari 7, 02610 Espoo (FI).

(81) Designated States (unless otherwise indicated, for every
kind of national protection available): AE, AG, AL, AM,
AO, AT, AU, AZ, BA, BB, BG, BH, BN, BR, BW, BY, BZ,
CA, CH, CL, CN, CO, CR, CU, CZ, DE, DK, DM, DO, DZ,
EC, EE, EG, ES, FI, GB, GD, GE, GH, GM, GT, HN, HR,
HU, ID, IL, IN, IR, IS, JP, KE, KG, KN, KP, KR, KZ, LA,
LC, LK, LR, LS, LU, LY, MA, MD, ME, MG, MK, MN,
MW, MX, MY, MZ, NA, NG, NI, NO, NZ, OM, PA, PE,
PG, PH, PL, PT, QA, RO, RS, RU, RW, SA, SC, SD, SE,
SG, SK, SL, SM, ST, SV, SY, TH, TJ, TM, TN, TR, TT, TZ,
UA, UG, US, UZ, VC, VN, ZA, ZM, ZW.

(84) Designated States (unless otherwise indicated, for every
kind of regional protection available): ARIPO (BW, GH,
GM, KE, LR, LS, MW, MZ, NA, RW, SD, SL, ST, SZ, TZ,
UG, ZM, ZW), Eurasian (AM, AZ, BY, KG, KZ, RU, TJ,
TM), European (AL, AT, BE, BG, CH, CY, CZ, DE, DK,
EE, ES, FI, FR, GB, GR, HR, HU, IE, IS, IT, LT, LU, LV,
MC, MK, MT, NL, NO, PL, PT, RO, RS, SE, SI, SK, SM,

(54) Title: PHYSIOLOGICAL MEASUREMENT PROCESSING

Fig. 1 100

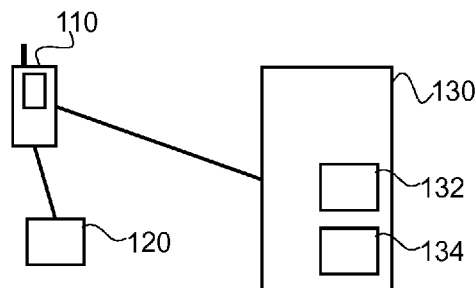

(57) Abstract: A method, apparatus, system and computer program in which customized event detection data are maintained for a person which include automatically: obtaining physiological measurement data indicative of physiological status of the person; receiving an annotation from the person; detecting an event that is temporally associated with the annotation using the physiological measurement data and the event detection data; and prioritizing the detected event using the temporally associated annotation.



PHYSIOLOGICAL MEASUREMENT PROCESSING

TECHNICAL FIELD

[0001] The present application generally relates to physiological measurement processing.

BACKGROUND

[0002] This section illustrates useful background information without admission of any technique described herein representative of the state of the art.

[0003] Patients with heart disease may be monitored to detect cardiac events with various means such as a worn pendant. If such events are detected, verbal verification is obtained to a question produced by speech synthesis. The verbal verification can be analyzed by speech recognition and used to prevent false alarms. In some cases, the medical condition of a patient is monitored with implantable medical devices to detect deviation from desired characteristics. If the monitoring indicates a severe condition, an alert may be generated, but in minor deviations, the patient may be queried about her symptoms for holistic diagnostic procedures.

SUMMARY

[0004] Various aspects of examples of the invention are set out in the claims.

[0005] According to a first example aspect of the present invention, there is provided a method comprising:

[0006] maintaining customized event detection data for a person; and automatically:

[0007] obtaining physiological measurement data indicative of physiological status of the person;

[0008] receiving an annotation from the person;

[0009] detecting an event that is temporally associated with the annotation using the physiological measurement data and the event detection data; and

[0010] prioritizing the detected event using the temporally associated annotation.

[0011] The annotation may be received by monitoring output of the person and identifying the annotation in the output of the person. The output of the person

comprise any of speech; utterance; gesture; textual output; use of a key; and any combination thereof.

[0012] The customized event detection data may comprise an anomaly limit for a physiological parameter. The anomaly limit may be a maximum or a minimum. The physiological parameter may concern any of heart rate; blood pressure; blood sugar; respiration rate; respiration flow rate; skin color; shivering; blood oxygen; electrocardiography; body temperature; and facial movement. The customized event detection data for a person may comprise any of age; weight; height; normal blood pressure; indication of one or more illnesses of the person; and maximum pulse of the person. The customized event detection data may comprise an anomaly pattern for a plurality of physiological parameters. The anomaly pattern may comprise a condition for a combination of thresholds.

[0013] The method may comprise responsive to a first condition supplementing the obtained physiological measurement data with one or more given physiological parameters. The first condition may comprise detecting a predetermined event. The customized event detection data may define the first condition.

[0014] The prioritizing may comprise using a machine learning process to determine estimated significance of the detected event. The prioritizing may combine the estimated significance of the detected event and the temporally associated annotation. The method may comprise classifying the detected events based on the combination of the estimated significance of the detected event and the temporally associated annotation.

[0015] The method may comprise responsive to detecting a predetermined event prompting the person to issue the annotation. The prompting of the person to issue the annotation may depend on the physiological measurement data and on the customized event detection data.

[0016] The method may comprise sending the physiological measurement data to a remote data processing system. The method may comprise sending to the remote data processing system an indication of the detected event. The indication of the detected event may comprise the time of the detected event. The indication of the detected event may comprise an indication of a type of the detected event. The method may comprise sending to the remote data processing system the annotation.

[0017] The method may comprise storing and batch sending the obtained

physiological measurement data and plural received annotations obtained and received over a period of time. The method may comprise batch sending the obtained physiological measurement data and plural received annotations based on a predetermined schedule and / or when a given volume of data has been collected. The method may comprise batch sending the obtained physiological measurement data and plural received annotations on detecting a predetermined event. The method may comprise batch sending the obtained physiological measurement data and plural received annotations on gaining a given network access. The method may comprise batch sending the obtained physiological measurement data and plural received annotations on receiving a delivery request. The delivery request may be received from the person. The delivery request may be received from a source other than the person. The source other than the person may be the remote data processing system or a person thereof.

[0018] The method may comprise receiving feedback data concerning the detecting of the event or the prioritizing of the detected events and calibrating the detecting of the event or the prioritizing of the detected events, respectively. The calibrating may comprise adjusting the customized event detection data.

[0019] The method may comprise producing a list of the detected events and associated annotations. The list may be ordered by the prioritizing. The list may comprise hyperlinks to corresponding physiological measurement data sections.

[0020] The obtaining of the physiological measurement data may comprise receiving information from a sensor. The sensor may be configured to continually measure at least one physiological property of the person. The sensor may be worn by the person. The sensor may be implanted. The obtaining of the physiological measurement data may comprise receiving information from a plurality of sensors. The sensors may measure same or different physiological properties.

[0021] The detecting of the event may be performed by a local processing unit. The local processing unit may be worn by the person. The local processing unit may be implanted. The local processing unit may be a portable device. The local processing unit may be a mobile communication device such as a mobile phone.

[0022] The prioritizing of the detected event may be performed by the local processing unit. Alternatively, the prioritizing of the detected event may be performed by a remote data processing system.

[0023] The remote data processing system may comprise a data cloud hosted server. The remote data processing system may comprise a supervisor terminal. The supervisor terminal may be configured to indicate the detected event and the annotation to the supervisor.

[0024] The method may further comprise receiving the feedback from the supervisor. The feedback may be received from the supervisor terminal. The supervisor may be a medically trained person such as a doctor. Alternatively, the supervisor may be an artificial intelligence circuitry configured to evaluate the physiological measurements using the annotations.

[0025] According to a second example aspect of the present invention, there is provided an apparatus comprising:

[0026] a memory configured to maintain customized event detection data for a person;

[0027] a local communication circuitry configured to obtain physiological measurement data indicative of physiological status of the person;

[0028] at least one processor configured to automatically perform:

[0029] obtaining physiological measurement data indicative of physiological status of the person;

[0030] receiving an annotation from the person;

[0031] detecting an event that is temporally associated with the annotation using the physiological measurement data and the event detection data; and

[0032] prioritizing the detected event using the temporally associated annotation.

[0033] The apparatus may comprise a user interface configured to receive the annotation from the person. The user interface may comprise a speech recognition circuitry configured to recognize spoken annotations from the person. The user interface may comprise a speech synthesis circuitry configured to output information to the user by speech. The speech recognition circuitry may be at least partly formed using the at least one processor. The speech synthesis circuitry may be at least partly formed using the at least one processor. The user interface may comprise a key configured to receive an annotation. The user interface may be configured to indicate a context for receiving context-sensitively the annotation. The user interface may be configured to prompt the annotation by one or more questions. The annotation may

comprise one or more parts provided by the person at one or more times.

[0034] According to a third example aspect of the present invention, there is provided a computer program comprising computer executable program code configured to execute any method of the first example aspect.

[0035] The computer program may be stored in a computer readable memory medium.

[0036] Any foregoing memory medium may comprise a digital data storage such as a data disc or diskette, optical storage, magnetic storage, holographic storage, opto-magnetic storage, phase-change memory, resistive random access memory, magnetic random access memory, solid-electrolyte memory, ferroelectric random access memory, organic memory or polymer memory. The memory medium may be formed into a device without other substantial functions than storing memory or it may be formed as part of a device with other functions, including but not limited to a memory of a computer, a chip set, and a sub assembly of an electronic device.

[0037] According to a fourth example aspect of the present invention, there is provided an apparatus comprising a memory and a processor that are configured to cause the apparatus to perform the method of the first example aspect.

[0038] Different non-binding example aspects and embodiments of the present invention have been illustrated in the foregoing. The embodiments in the foregoing are used merely to explain selected aspects or steps that may be utilized in implementations of the present invention. Some embodiments may be presented only with reference to certain example aspects of the invention. It should be appreciated that corresponding embodiments may apply to other example aspects as well.

BRIEF DESCRIPTION OF THE DRAWINGS

[0039] For a more complete understanding of example embodiments of the present invention, reference is now made to the following descriptions taken in connection with the accompanying drawings in which:

[0040] Fig. 1 shows an architectural drawing of a system of an example embodiment;

[0041] Figs. 2a and 2b show a flow chart of a various process steps that are implemented in some example embodiments;

[0042] Fig. 3 shows an example of a prioritizing look-up table of an example

embodiment;

[0043] Fig. 4 shows an example of a an event and annotation table of an example embodiment;

[0044] Fig. 5 shows a graph illustrating the detection of event data according to an example embodiment;

[0045] Fig. 6 shows some alternative scenarios of event detection taking the annotations into account according to an example embodiment;

[0046] Fig. 7 shows a chart illustrating development of detected events in an example; and

[0047] Fig. 8 shows a block diagram of a local processing unit.

DETAILED DESCRIPTON OF THE DRAWINGS

[0048] An example embodiment of the present invention and its potential advantages are understood by referring to Figs. 1 through 8 of the drawings. In this document, like reference signs denote like parts or steps.

[0049] Fig. 1 shows an architectural drawing of a system 100 of an example embodiment. The system comprises a local processing unit 110, one or more physiological measurement sensors 120 or biosensors in short (here only one is drawn in sake of simplicity), and a remote data processing system 130 comprising a plurality of supervisor terminals 132 and a database 134.

[0050] The local processing unit is in some implementations worn by the person, in some cases it can be implanted or a portable device or a mobile communication device such as a mobile phone. The local processing unit is in some embodiments integrated with at least one of the sensors 120.

[0051] In some embodiments, the remote data processing system 130 comprises a data cloud hosted server computer, a virtualized server computer, and / or a dedicated server computer.

[0052] The supervisor terminal can be used by a supervisor. The supervisor is, for example, a medically trained person such as a doctor or an artificial intelligence circuitry configured to evaluate the physiological measurements using the annotations.

[0053] Fig. 1 is simplified in that the remote data processing system 130 can typically operate with a large number of local processing units 110 and supervisor terminals 132.

[0054] Figs. 2a and 2b show a flow chart of a various process steps that are implemented in some example embodiments. Notice that not all the steps are necessarily taken, and some steps may be taken twice and also it is possible to further perform other steps in addition or instead of any of these steps. These steps include:

202 maintaining customized event detection data for a person; and automatically:

204 obtaining physiological measurement data indicative of physiological status of the person;

206 receiving an annotation from the person (in some embodiments, annotations can additionally be automatically created);

208 detecting an event that is temporally associated with the annotation using the physiological measurement data and the event detection data; and

210 prioritizing the detected event using the temporally associated annotation.

212 performing the receiving of the annotation by monitoring output of the user and identifying the annotation in the output of the user, the output of the user possibly comprising any of speech; utterance; gesture; textual output; use of a key; and any combination thereof, for example;

214 responsive to a first condition supplementing the obtained physiological measurement data with one or more given physiological parameters. In some embodiments, the first condition comprises detecting a predetermined event. The customized event detection data may define the first condition. For example, in case of heart patients, on meeting the first condition, an intrusive blood measurement may be made if the pulse exceeds a set threshold for the person in question.

216 Using a machine learning process to determine estimated significance of the detected event. For example, the limits of normal heart rate can be detected particularly using the annotations to verify that that peaks are exercise related or potentially interrelated patterns can be detected.

218 Combining, in the prioritizing, the estimated significance of the detected event and the temporally associated annotation. The combining of the estimated significance and the associated annotation enables highlighting potentially relevant event information for a supervisor such as a doctor very efficiently out of even large masses of physiological measurement data.

220 Classifying the detected events based on the combination of the estimated significance of the detected event and the temporally associated annotation.

222 Responsive to detecting a predetermined event prompting the person to issue the annotation. In some embodiments, the annotation can thus be enquired. For example, sometimes high pulse can be caused by emotional stimulus and the person facing such a situation might easily forget to provide annotations by speech, for example, of his or her own initiative. Moreover, the prompting can enable potentially identifying temporary loss of consciousness that could coincide with some unusual physiological changes that could appear in the measurements of the biosensor(s). The prompting can be implemented to take place depending on the physiological measurement data and on the customized event detection data for example such that persons with earlier heart attacks are easier prompted to annotate biosensor measurement changes that otherwise might not need further attention. The prompting can be made to direct the annotation to potentially useful information such as whether a person having a serious disease has taken the prescribed medication and whether she experiences symptoms that are commonly related to a disease that should be rapidly identified.

224 Sending information to a remote data processing system. The information comprises any of an indication of the detected event; the time of the detected event; an indication of a type of the detected event; and the annotation. By sending collected and/or derived information to the remote data processing system these data can be made available to a check by the supervisor. For example, some heart diseases are not always visible in the ECG graphs and modern technology may enable early detection of signs of a new stroke sufficiently in advance to take preventive action, if these signs are observed in time. Automatic diagnostics tools have been developed to help with this regard but their reliability and ability to compete with real doctors may still be limited and there may be liability reasons, for example, that inhibit the use of such tools. Automatic obtaining of physiological measurement data and event processing with reporting to the remote processing system may yet enable fast informing of a qualified supervisor of potentially relevant events. The diagnostic work can be left for such a professional or perhaps be performed by an artificial intelligence circuitry configured to perform the work of such a professional.

226 Storing and batch sending stored information. The stored information comprises any of the obtained physiological measurement data; received annotations obtained and received over a period of time; obtained physiological measurement data. The batch sending is timed in some embodiments based on a predetermined schedule.

Additionally, or alternatively, the batch sending can be performed when a given volume of data has been gathered. The batch sending can be alternatively made only or additionally on any of: detecting a predetermined event; gaining a given network access; and receiving a delivery request. For example, the batch sending can be normally effected when a free network connection is available, unless there is detected an event that meets given conditions or a request is made by someone.

228 Receiving feedback data concerning the detecting of the event or the prioritizing of the detected events and calibrating the detecting of the event or the prioritizing of the detected events, respectively. The calibrating involves in some embodiments adjusting the customized event detection data.

230 Producing a list of the detected events and associated annotations. The list is ordered in some embodiments by the prioritizing, for example, and the list optionally comprises hyperlinks to corresponding physiological measurement data sections.

232 Receiving information from a sensor when obtaining the physiological measurement data, wherein the sensor is in some embodiments configured to continually measure at least one physiological property of the person. In some embodiments the sensor is worn by the person. In some cases, the sensor can be implanted. For example, a blood flow sensor could be implanted whereas a sweating sensor could be implemented with an on-the-skin sensor. Different sensors can be used in different embodiments without limitation to their type and implementation. For example, an artificial heart valve can be furnished with a sensor capable of wirelessly issuing (with RFID, for example) indications of the pulse or blood flow or the person could simply wear on her wrist a watch equipped with one or more sensors such as pulse and blood oxygen measurements.

234 Performing the detecting of the event by a local processing unit. The detecting of the event can be implemented in any suitable technique accounting for the nature of the sensor data and the nature of the event. For example, anomalies in pulse can be found by simply comparing the measured pulse to threshold limits, whereas anomalies in the ECG characteristics may require more complex processing such as determining the development curve of a signal or the mutual changes of measurements by different sensors.

236 Performing the prioritizing of the detected event by the local processing unit or by the remote data processing system 130. The annotations can be used in the detecting

of the events so that some sensor data changes can be understood as very significant changes and others as simple malfunctions such as detachment of a sensor in accident or by the person's own choice. On the other hand, the annotations can be used alternatively or additionally in the prioritizing to weigh more or less some events based on the annotations. The prioritizing can be made using predetermined prioritizing criteria, which can be arranged using set functions or look-up tables, for example. Fig. 3 shows an example of a prioritizing look-up table that exemplifies preset priority values 310 for given combinations of detected most likely events 320 and the annotations 330 given by the person or obtained otherwise (e.g. by cable condition measurement).

238 Indicating the detected event and the annotation to the supervisor by the supervisor terminal. This can be performed, for example, by displaying a table or chart such as that shown in Fig. 4. The table shown in Fig. 4 comprises set priorities 410 based on the events 420 and annotations 430 and notes 440 recorded by the supervisor or fields in which such notes can be recorded if none present yet, and an optional suppress box 450 in which it can be defined that no further corresponding events should be reported at least in the presently used priority. In one embodiment, the suppressing results in lowering the priority of such events in future reports by one step, for example.

240 Receiving the feedback from the supervisor, using the supervisor terminal for example. This can be performed on the supervisor terminal by filling in particular feedback or notes fields in the table shown to the supervisor, for example, so as to enable simultaneous displaying of detected events, annotations of the person and the notes of the supervisor.

[0055] The customized event detection data comprise in an example embodiment an anomaly limit for a physiological parameter such as a maximum or a minimum. The physiological parameter concerns any of heart rate; blood pressure; blood sugar; respiration rate; respiration flow rate; skin color; shivering; blood oxygen; electrocardiography; body temperature; and facial movement, for example. The customized event detection data for a person comprise, for example, any of age; weight; height; normal blood pressure; indication of one or more illnesses of the person; and maximum pulse of the person. In some embodiments, the customized event detection data comprises an anomaly pattern for a plurality of physiological

parameters. In an example embodiment, the anomaly pattern comprises a condition for a combination of thresholds.

[0056] Fig. 5 illustrates the detection of event data by showing a graph and how events are detected and annotations given by the person. First, during a period when a person is likely feeling bad 508, a likely anomaly is detected, 502. In the absence of an unsolicited annotation, the person is prompted 504 to tell how she feels, but no response is received. Hence, an alert is raised 506. Then, during another period, the person is likely feeling good 512. Likely normal operation is detected 510. In some embodiments, then a supplemental report can be sent to the remote data processing system 130 or the earlier sent information may be corrected by clearing the alert, for example.

[0057] Fig. 6 shows some alternative scenarios of event detection taking the annotations into account. First, it is detected that the person is likely to feel bad by monitoring the sensor data, 602. No annotation is received from the person and the event is thus assigned a high priority as apparently suspicious, 604. Next, a similar sensor data is received in 610, but the person annotates that she feels good, 612. Hence, no action appears necessary and the event is classified to some intermediate priority level. Finally, a malfunction situation is presented, 620. Here, the person annotates that there was a cable problem, 622, and the event is classified as a technical problem.

[0058] Fig. 7 shows an example of possible development of detected events, annotations and determined priorities formed by combining the detected events and annotations. In the case of Fig. 7 all the detected events are measurement-wise equal i.e. the measured signal is the same in each, hence prioritization of events is effectively determined based on annotations.

[0059] Fig. 8 shows a block diagram of the local processing unit 110 comprising: a memory 810 configured to maintain customized event detection data 812 for a person; a local communication circuitry 820 configured to obtain physiological measurement data indicative of physiological status of the person; at least one processor 830 configured to automatically perform: obtaining physiological measurement data indicative of physiological status of the person; receiving an annotation from the person; detecting an event that is temporally associated with the annotation using the physiological measurement data and the event detection data;

and prioritizing the detected event using the temporally associated annotation.

[0060] The memory 810 can be used to store computer software such as executable program code 814 or instructions executing which the at least one processor may control operations of the local processing unit 110.

[0061] The local processing unit 110 of Fig. 8 further comprises a user interface 840 configured to receive the annotation from the person. The user interface of Fig. 8 comprises a speech recognition circuitry 842 configured to recognize spoken annotations from the person and a speech synthesis circuitry 844 configured to output information to the user (i.e. person) by speech. Either or both the speech recognition circuitry 842 and the speech synthesis circuitry 844 can be at least partly implemented using the at least one processor 830 or remote processing equipment. For example, speech of the person is recorded in one example embodiment and sent as such or with some pre-processing to a network-based processing function (e.g. a cloud-based server). Speech synthesis is at least partly distributed a function in one example embodiment so that the speech is at least partly generated in an external processing function and therefrom transferred to the local processing unit 110 for output to the person. The user interface of Fig. 8 further comprises a key 846 configured to receive an annotation, such as an emergency button and a display 848 for displaying information. The user interface can be configured to indicate a context for receiving context-sensitively the annotation under control of the at least one processor 830, for example. The user interface can be configured to prompt the annotation by one or more specifying questions. The annotation may comprise one or more parts provided by the person at one or more times. The local processing unit 110 of Fig. 8 further comprises a communication unit 850 for communicating with the remote data processing system 130. The communication unit 850 comprises, for example, a local area network (LAN) port; a wireless local area network (WLAN) unit; a cellular data communication unit; or satellite data communication unit. The at least one processor 830 comprises, for example, any one or more of: a master control unit (MCU); a microprocessor; a digital signal processor (DSP); an application specific integrated circuit (ASIC); a field programmable gate array; and a microcontroller.

[0062] Without in any way limiting the scope, interpretation, or application of the claims appearing below, a technical effect of one or more of the example embodiments disclosed herein is that large amount of sensor data can be processed

to identify potentially relevant events taking into account feedback of the person being measured and the measurement data can be appropriately prioritized for subsequent verification by a supervisor. Another technical effect of one or more of the example embodiments disclosed herein is that delivery of irrelevant alerts can be inhibited by receiving and processing annotations of the person.

[0063] Embodiments of the present invention may be implemented in software, hardware, application logic or a combination of software, hardware and application logic. The software, application logic and/or hardware may reside on the local processing unit 110, the remote data processing system 130 or both. If desired, part of the software, application logic and/or hardware may reside on the local processing unit 110, and a part of the software, application logic and/or hardware may reside on the remote data processing system 130. In an example embodiment, the application logic, software or an instruction set is maintained on any one of various conventional computer-readable media. In the context of this document, a “computer-readable medium” may be any non-transitory media or means that can contain, store, communicate, propagate or transport the instructions for use by or in connection with an instruction execution system, apparatus, or device, such as a computer, with one example of a computer described and depicted in Fig. 8. A computer-readable medium may comprise a computer-readable storage medium that may be any media or means that can contain or store the instructions for use by or in connection with an instruction execution system, apparatus, or device, such as a computer.

[0064] If desired, the different functions discussed herein may be performed in a different order and/or concurrently with each other. Furthermore, if desired, one or more of the before-described functions may be optional or may be combined.

[0065] Although various aspects of the invention are set out in the independent claims, other aspects of the invention comprise other combinations of features from the described embodiments and/or the dependent claims with the features of the independent claims, and not solely the combinations explicitly set out in the claims.

[0066] It is also noted herein that while the foregoing describes example embodiments of the invention, these descriptions should not be viewed in a limiting sense. Rather, there are several variations and modifications which may be made without departing from the scope of the present invention as defined in the appended

claims.

CLAIMS

1. A method comprising:
 - maintaining customized event detection data for a person; and automatically:
 - 5 obtaining physiological measurement data indicative of physiological status of the person;
 - receiving an annotation from the person;
 - detecting an event that is temporally associated with the annotation using the physiological measurement data and the event detection data; and
 - 10 prioritizing the detected event using the temporally associated annotation.

2. The method of claim 1, wherein the annotation is received by monitoring output of the person and identifying the annotation in the output of the person.

- 15 3. The method of claim 1, wherein the output of the person comprises any of speech and utterance.

4. The method of any one of the preceding claims, wherein the customized event detection data comprises an anomaly limit for a physiological parameter.
- 20 5. The method of claim 4, wherein the anomaly limit is a maximum or a minimum.

6. The method of claim 4 or 5, wherein the physiological parameter concerns
25 any of heart rate; blood pressure; blood flow rate; blood sugar; respiration rate; respiration flow rate; skin color; shivering; blood oxygen; electrocardiography; body temperature; and facial movement.

7. The method of any one of the preceding claims, wherein the customized
30 event detection data comprises an anomaly pattern for a plurality of physiological parameters.

8. The method of any one of the preceding claims, wherein the method
35 comprises responsive to a first condition supplementing the obtained physiological measurement data with one or more given physiological parameters.

9. The method of claim 8, wherein the first condition comprises detecting a predetermined event.

5 10. The method of claim 8 or 9, wherein the customized event detection data defines the first condition.

10 11. The method of any one of the preceding claims, wherein the prioritizing comprises using a machine learning process to determine estimated significance of the detected event.

12. The method of claim 11, wherein the prioritizing combines the estimated significance of the detected event and the temporally associated annotation.

15 13. The method of any one of the preceding claims, wherein the method comprises responsive to detecting a predetermined event prompting the person to issue the annotation.

20 14. The method of claim 13, wherein the prompting of the person to issue the annotation depends on the physiological measurement data and on the customized event detection data.

25 15. The method of any one of the preceding claims, wherein the method comprises sending the physiological measurement data to a remote data processing system.

16. The method of claim 15, wherein the method comprises sending to the remote data processing system an indication of the detected event.

30 17. The method of claim 15 or 16, wherein the method comprises sending to the remote data processing system the annotation.

35 18. The method of any one of the preceding claims, wherein the method comprises storing and batch sending the obtained physiological measurement data and plural received annotations obtained and received over a period of time.

19. The method of any one of the preceding claims, wherein the method comprises receiving feedback data concerning the detecting of the event or the prioritizing of the detected events and calibrating the detecting of the event or the prioritizing of the detected events, respectively.

5

20. The method of claim 19, wherein the calibrating comprises adjusting the customized event detection data.

21. The method of any one of the preceding claims, wherein the obtaining of the physiological measurement data comprises receiving information from a sensor.

10

22. The method of any one of the preceding claims, wherein the detecting of the event is performed by a local processing unit.

23. The method of any one of the preceding claims, wherein the prioritizing of the detected event is performed by the local processing unit.

15

24. An apparatus comprising:

a memory configured to maintain customized event detection data for a person;

20

a local communication circuitry configured to obtain physiological measurement data indicative of physiological status of the person;

at least one processor configured to automatically perform:

obtaining physiological measurement data indicative of physiological status of the person;

25

receiving an annotation from the person;

detecting an event that is temporally associated with the annotation using the physiological measurement data and the event detection data; and

prioritizing the detected event using the temporally associated annotation.

30

25. The apparatus of claim 24, comprising a user interface configured to receive the annotation from the person.

26. The apparatus of claim 24, comprising a speech recognition circuitry configured to recognize spoken annotations from the person.

27. The apparatus of any one of claims 24 to 26, configured to indicate a context
5 for receiving context-sensitively the annotation.

28. A system comprising the apparatus of any one of claims 24 to 27 and a sensor configured to continually measure at least one physiological property of the person, wherein the apparatus is configured to obtain the physiological
10 measurement data at least partly from the sensor.

29. The system of claim 28, wherein the sensor is worn by the person.

30. The system of claim 28 or 29, comprising a remote data processing system,
15 wherein the apparatus is configured to send an indication of the detected event and the annotation to the remote data processing system.

31. A computer program comprising computer executable program code configured to execute any method of any one of claims 1 to 23.
20

32. The computer program of claim 31 stored in a non-transitory memory medium.

33. An apparatus comprising a memory and a processor that are configured to
25 cause the apparatus to perform the method of any one of claims 1 to 23.

Fig. 1 100

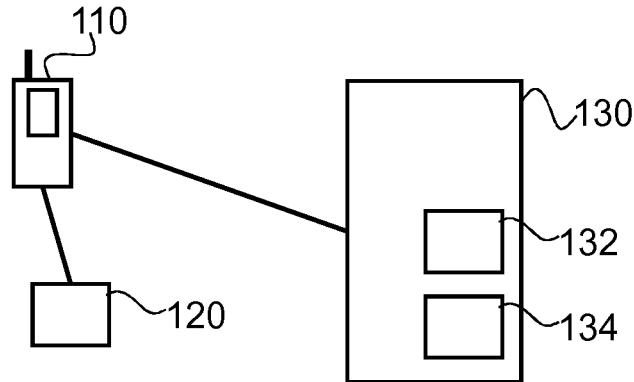

Fig. 2a

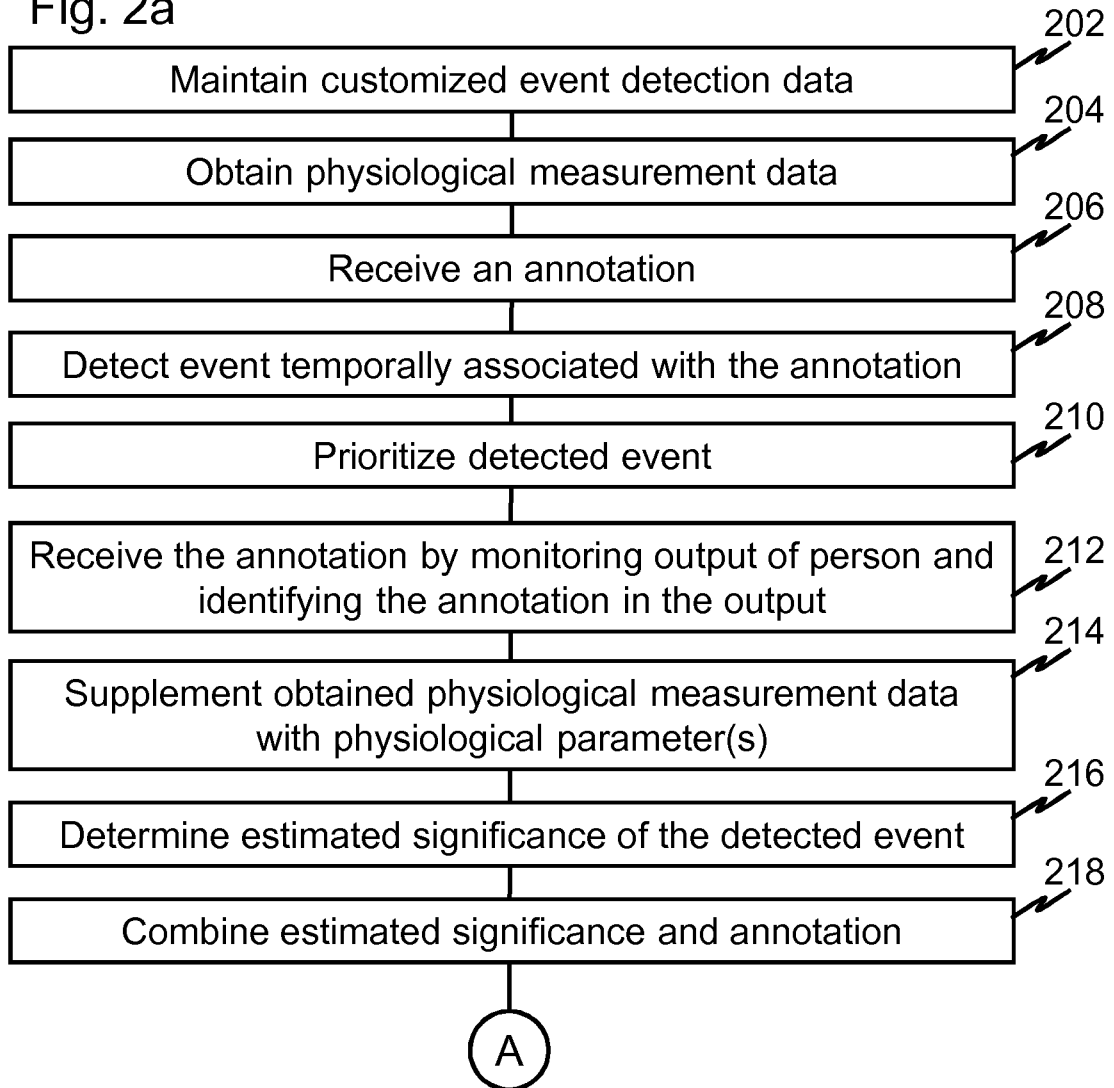

Fig. 2b

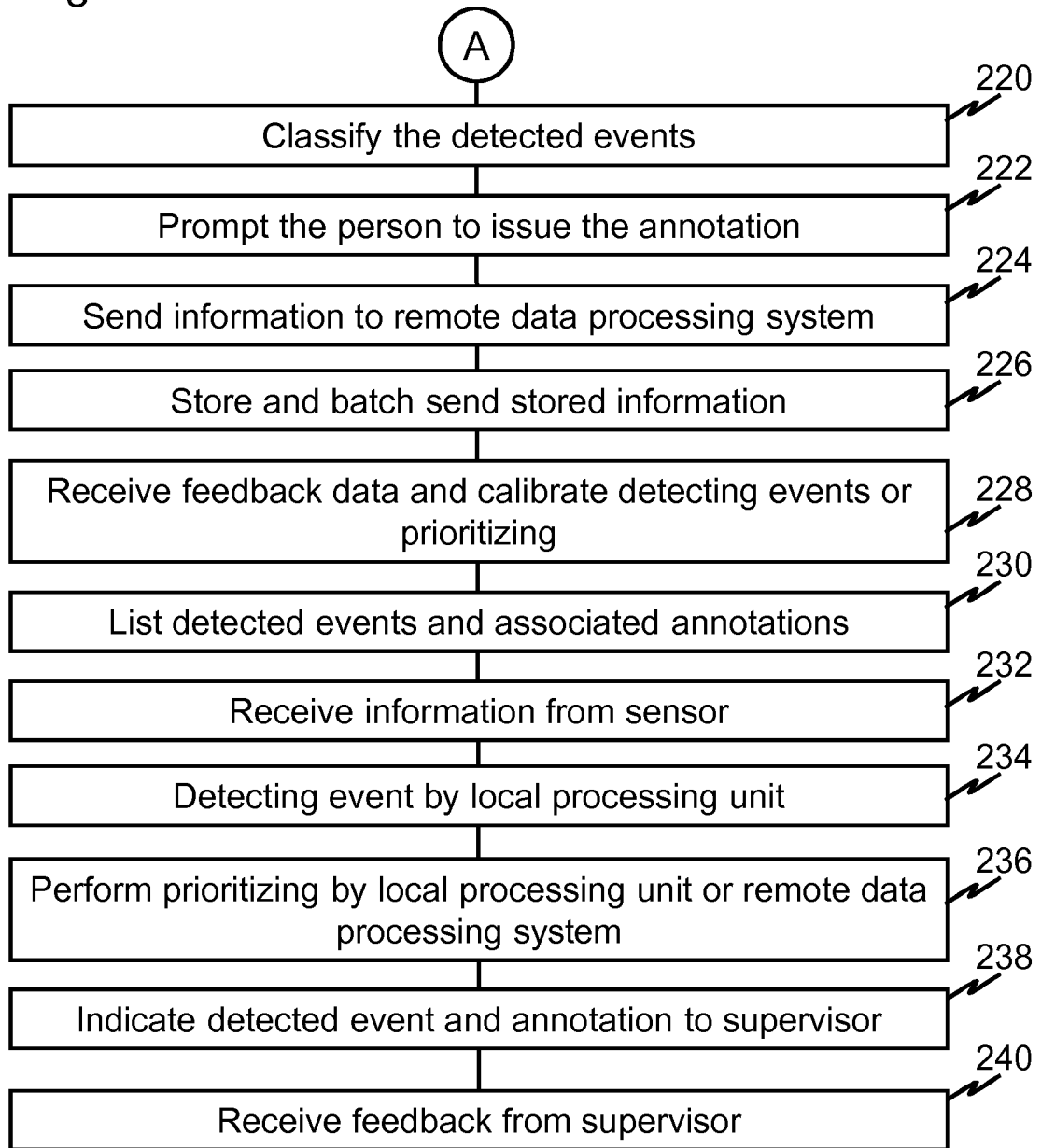

Fig. 3

Priority	Event	Annotation
1.	Arrythmia	None or negative
1.	Fast pace	Very negative
2.	Arrythmia	Little negative
1.	Brain seizure	Any
2.	Muscle cramp	Very negative
3.	Any	Cable problem

Fig. 4

Priority	Event	Annotation	Notes	Suppress?
1.	Arrythmia	-	NFS	
2.	Fast pace	Feel v. bad	NFS	
3.	Arrythmia	Feel little bad	Maybe nothing	
4.	Fast pace	-	Maybe nothing	
5.	Fast pace	Exercising	Ignore	
6.	Arrythmia	Cable problem	Ignore; call repair?	
7.	No signal	In sauna	Ignore	

Fig. 5

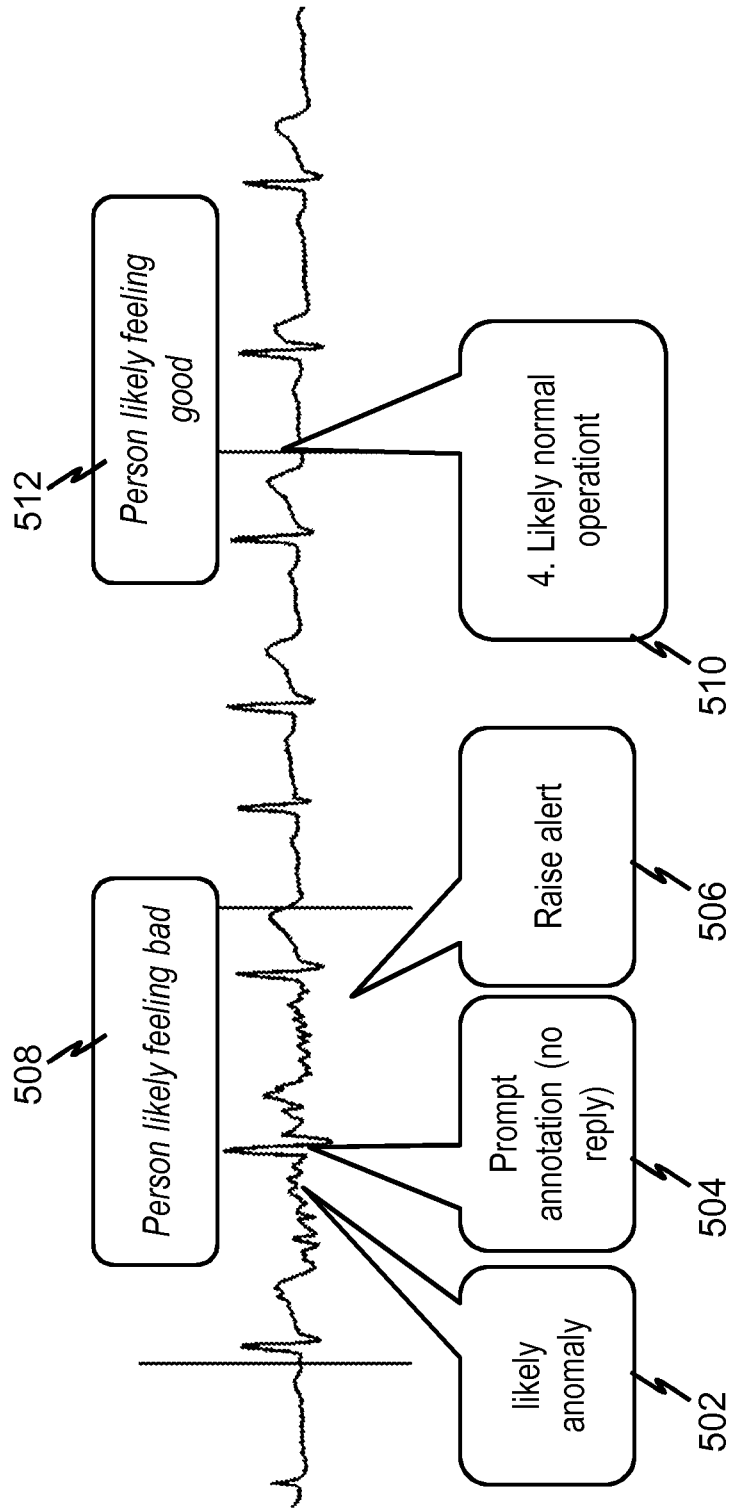

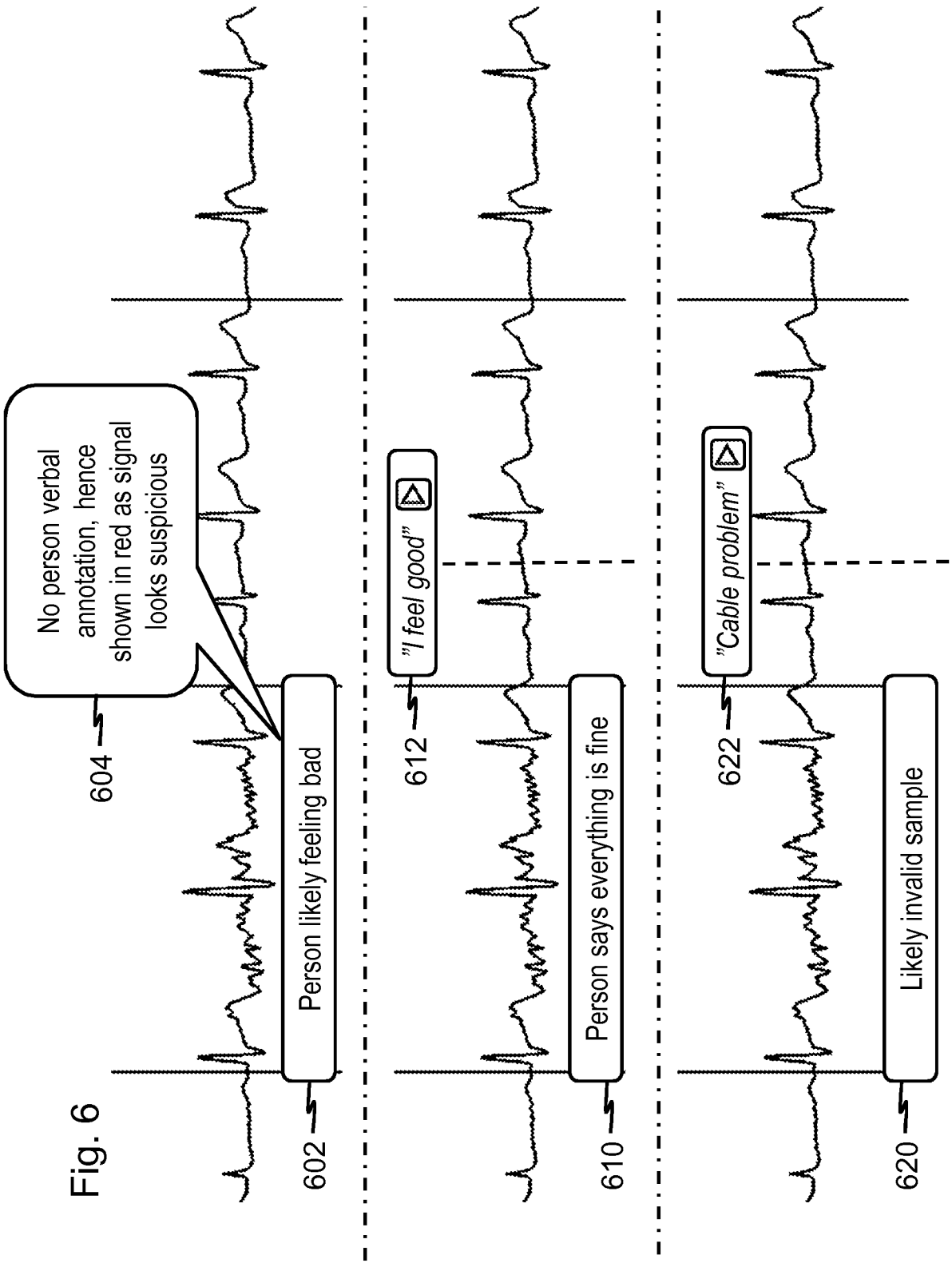
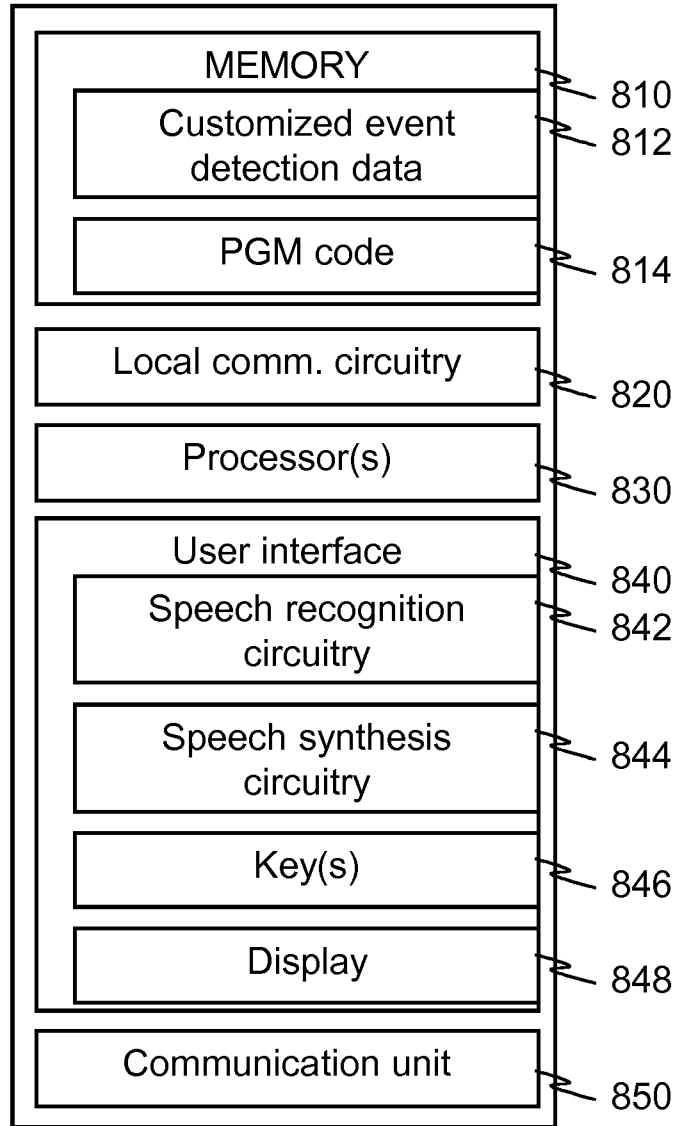

Fig. 6

Fig. 7



Fig. 8



INTERNATIONAL SEARCH REPORT

International application No.

PCT/FI2016/050276

A. CLASSIFICATION OF SUBJECT MATTER

See extra sheet

According to International Patent Classification (IPC) or to both national classification and IPC

B. FIELDS SEARCHED

Minimum documentation searched (classification system followed by classification symbols)

IPC: A61B, A61M, A61N, G01N, G06F, G06Q, G10L

Documentation searched other than minimum documentation to the extent that such documents are included in the fields searched

FI, SE, NO, DK

Electronic data base consulted during the international search (name of data base, and, where practicable, search terms used)

EPODOC, WPIAP, TXPEPEA, TXPUSE0A, TXPUSE1A, TXPUSEA, TXPUSEB, TXPW0EA, TXPEA, TXPEB, TXPEC, TXPEE, TXPEF, TXPEH, TXPEI, TXPEP, TXPES

C. DOCUMENTS CONSIDERED TO BE RELEVANT

Category*	Citation of document, with indication, where appropriate, of the relevant passages	Relevant to claim No.
X	US 2008300572 A1 (RANKERS ULRICH [US] et al.) 04 December 2008 (04.12.2008) paragraphs [0005], [0038]-[0039], [0080], [0084], [0092], [0114]-[0116], [0169], [0175]-[0186], claim 17, figures 6, 8, 11	1-33
X	US 2015066538 A1 (DANESKER EUGENE [US] et al.) 05 March 2015 (05.03.2015) paragraphs [0003]-[0012], [0027], [0035]-[0039], [0088]-[0089], [0093], [0097]-[0098], [0106]-[0107], [0133], [0146], figure 1	1, 24, 28, 31, 32, 33
X	US 2012078064 A1 (BARDY GUST H [US]) 29 March 2012 (29.03.2012) paragraphs [0010]-[0017], [0033], [0036], [0047], [0050]-[0058], [0064]-[0067], claims 1, 6, figures 8A, 8B, 12A, 12B	1, 24, 28, 31, 32, 33

 Further documents are listed in the continuation of Box C.
 See patent family annex.

* Special categories of cited documents:	"T" later document published after the international filing date or priority date and not in conflict with the application but cited to understand the principle or theory underlying the invention
"A" document defining the general state of the art which is not considered to be of particular relevance	"X" document of particular relevance; the claimed invention cannot be considered novel or cannot be considered to involve an inventive step when the document is taken alone
"E" earlier application or patent but published on or after the international filing date	"Y" document of particular relevance; the claimed invention cannot be considered to involve an inventive step when the document is combined with one or more other such documents, such combination being obvious to a person skilled in the art
"L" document which may throw doubts on priority claim(s) or which is cited to establish the publication date of another citation or other special reason (as specified)	"&" document member of the same patent family
"O" document referring to an oral disclosure, use, exhibition or other means	
"P" document published prior to the international filing date but later than the priority date claimed	

Date of the actual completion of the international search

25 August 2016 (25.08.2016)

Date of mailing of the international search report

01 September 2016 (01.09.2016)

Name and mailing address of the ISA/FI
Finnish Patent and Registration Office
P.O. Box 1160, FI-00101 HELSINKI, Finland
Facsimile No. +358 9 6939 5328

Authorized officer
L Eronen
Telephone No. +358 9 6939 500

INTERNATIONAL SEARCH REPORT
Information on Patent Family Members

International application No.
PCT/FI2016/050276

Patent document cited in search report	Publication date	Patent family members(s)	Publication date
US 2008300572 A1	04/12/2008	CA 2683827 A1	11/12/2008
		EP 2150296 A2	10/02/2010
		EP 2500049 A1	19/09/2012
		US 2010010330 A1	14/01/2010
		WO 2008150633 A2	11/12/2008
.....			
US 2015066538 A1	05/03/2015	CN 105518626 A	20/04/2016
		EP 3042326 A1	13/07/2016
		KR 20160048828 A	04/05/2016
		WO 2015034761 A1	12/03/2015
.....			
US 2012078064 A1	29/03/2012	US 8369937 B2	05/02/2013
		AU 751739 B2	29/08/2002
		AU 7157200 A	16/08/2001
		CA 2325657 A1	16/05/2001
		CA 2325657 C	08/02/2005
		EP 1102200 A2	23/05/2001
		EP 2015211 A1	14/01/2009
		US 6440066 B1	27/08/2002
		US 2002188213 A1	12/12/2002
		US 6834203 B2	21/12/2004
		US 2004039605 A1	26/02/2004
		US 6951539 B2	04/10/2005
		US 2005096510 A1	05/05/2005
		US 7117028 B2	03/10/2006
		US 2006293573 A1	28/12/2006
		US 8092382 B2	10/01/2012
		US 2013158361 A1	20/06/2013
		US 8731648 B2	20/05/2014
		US 2014171810 A1	19/06/2014
US 8942794 B2	27/01/2015		
.....			

CLASSIFICATION OF SUBJECT MATTER

IPC
A61B 5/00 (2006.01)
G06F 19/00 (2011.01)
G06Q 50/24 (2012.01)

专利名称(译)	生理测量处理		
公开(公告)号	EP3448238A1	公开(公告)日	2019-03-06
申请号	EP2016900321	申请日	2016-04-29
[标]申请(专利权)人(译)	诺基亚技术有限公司		
申请(专利权)人(译)	NOKIA TECHNOLOGIES OY		
当前申请(专利权)人(译)	NOKIA TECHNOLOGIES OY		
[标]发明人	SAVOLAINEN TEEMU		
发明人	SAVOLAINEN, TEEMU		
IPC分类号	A61B5/00 G06F19/00 G06Q50/24 G16H10/60		
CPC分类号	A61B5/02055 A61B5/02438 A61B5/0816 A61B5/7267 A61B5/7282 A61B5/749 G16H10/60 G16H40/63		
其他公开文献	EP3448238A4		
外部链接	Espacenet		

摘要(译)

一种方法，装置，系统和计算机程序，其中为人保持定制的事件检测数据，其自动包括：获得指示人的生理状态的生理测量数据；从所述人接收注释；使用所述生理测量数据和所述事件检测数据检测与所述注释在时间上相关联的事件；并使用时间相关的注释对检测到的事件进行优先级排序。