

(19) World Intellectual Property Organization  
International Bureau



(43) International Publication Date  
26 October 2006 (26.10.2006)

PCT

(10) International Publication Number  
**WO 2006/113804 A2**

(51) International Patent Classification:

A61B 5/00 (2006.01) A61B 5/103 (2006.01)  
A61B 5/04 (2006.01)

(21) International Application Number:

PCT/US2006/014737

(22) International Filing Date: 19 April 2006 (19.04.2006)

(25) Filing Language: English

(26) Publication Language: English

(30) Priority Data:

60/673,331 20 April 2005 (20.04.2005) US

(71) Applicant (for all designated States except US): **VIVO-METRICS, INC.** [US/US]; 121 N. Fir Street, Suite E, Ventura, CA 93001 (US).

(72) Inventors; and

(75) Inventors/Applicants (for US only): **DERCHAK, P., Alexander** [US/US]; 9 Beekman Terrace, Summit, NJ 07901 (US). **OSTERTAG, Kathryn, Lynn** [US/US]; 7b Standish Court, Greenfield, MA 01301 (US).

(74) Agents: **FANUCCI, Allan, A.** et al.; Winston & Strawn LLP, Patent Department, 1700 K Street, N.W., Washington, DC 20006-3817 (US).

(81) Designated States (unless otherwise indicated, for every kind of national protection available): AE, AG, AL, AM, AT, AU, AZ, BA, BB, BG, BR, BW, BY, BZ, CA, CH, CN, CO, CR, CU, CZ, DE, DK, DM, DZ, EC, EE, EG, ES, FI, GB, GD, GE, GH, GM, HR, HU, ID, IL, IN, IS, JP, KE, KG, KM, KN, KP, KR, KZ, LC, LK, LR, LS, LT, LU, LV, LY, MA, MD, MG, MK, MN, MW, MX, MZ, NA, NG, NI, NO, NZ, OM, PG, PH, PL, PT, RO, RU, SC, SD, SE, SG, SK, SL, SM, SY, TJ, TM, TN, TR, TT, TZ, UA, UG, US, UZ, VC, VN, YU, ZA, ZM, ZW.

(84) Designated States (unless otherwise indicated, for every kind of regional protection available): ARIPO (BW, GH, GM, KE, LS, MW, MZ, NA, SD, SL, SZ, TZ, UG, ZM, ZW), Eurasian (AM, AZ, BY, KG, KZ, MD, RU, TJ, TM), European (AT, BE, BG, CH, CY, CZ, DE, DK, EE, ES, FI, FR, GB, GR, HU, IE, IS, IT, LT, LU, LV, MC, NL, PL, PT, RO, SE, SI, SK, TR), OAPI (BF, BJ, CF, CG, CI, CM, GA, GN, GQ, GW, ML, MR, NE, SN, TD, TG).

Published:

— without international search report and to be republished upon receipt of that report

For two-letter codes and other abbreviations, refer to the "Guidance Notes on Codes and Abbreviations" appearing at the beginning of each regular issue of the PCT Gazette.

(54) Title: SYSTEMS AND METHODS FOR NON-INVASIVE PHYSIOLOGICAL MONITORING OF NON-HUMAN ANIMALS

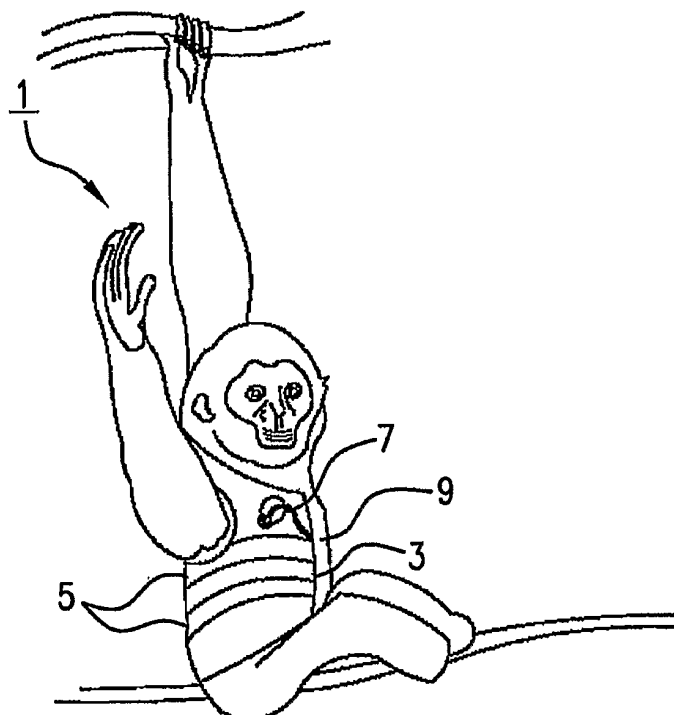

(57) Abstract: This invention provides monitoring garments for non-invasively monitoring physiological parameters in un-restrained and/or restrained animals, such as monkeys, rabbits, dogs, horses, and the like. The invention also includes methods and systems for collecting and processing monitoring data.

WO 2006/113804 A2

## SYSTEMS AND METHODS FOR NON-INVASIVE PHYSIOLOGICAL MONITORING OF NON-HUMAN ANIMALS

---

### FIELD OF THE INVENTION

The present invention relates to non-invasive physiological monitoring of restrained and/or unrestrained non-human animals, and more particularly provides monitoring systems  
5 for collecting physiological data from animals and methods for collecting and interpreting data.

### BACKGROUND OF THE INVENTION

Pharmaceutical compounds are subject to extensive testing before approval for general use. Early stages of this testing (pre-clinical) require demonstrating that a proposed  
10 compound is safe to administer to humans. To so demonstrate, prior to any human administration, a proposed compound is administered to animals with physiological responses similar to humans. During such animal testing, physiological and biological systems of a test animal must be monitored to detect any adverse effects that might occur. It is preferred that physiological monitoring not entail invasive procedures and that during monitoring test  
15 animals are unrestrained.

Specifically, because of their similarity to humans, primates, especially monkeys, are preferred pre-clinical testing animals. However, accurately monitoring respiratory volumes of monkeys has required physically immobilizing the monkeys and placing a face mask over their faces. Monitoring unrestrained monkeys has been possible, but only by surgically  
20 implanting into the monkey a monitoring device sensitive to intra-pleural pressure. Data returned from such an implanted device is responsive to respiratory rate, but contains virtually no information on respiratory volumes. Further, the associated surgical procedure is unpleasant at best and often painful for the monkeys, adds to monitoring expense, requires healing after surgery that delays monitoring procedures, and causes an inevitable risk of  
25 infection. And once implanted, the device is susceptible to failure and in some cases self-extraction by the monkey.

Additionally, other fields can benefit from facilities for non-invasive physiological monitoring of unrestrained animals that are currently not readily available. For example, veterinary practice, both medical and surgical, would benefit from readily available  
30 physiological monitoring of unrestrained animals. Such monitoring would also enable more

precise and accurate animal evaluation and training. Such monitoring can also be beneficial to ecological or behavioral studies of free ranging animals.

For these and for other reasons, the arts are in need of non-invasive physiological testing systems that provide respiratory and other physiological data from restrained and/or unrestrained monkeys and/or other test animals.

A number of references are cited herein, the entire disclosures of which are incorporated herein, in their entirety, by reference for all purposes. Further, none of these references, regardless of how characterized above, is admitted as prior to the invention of the subject matter claimed herein.

## SUMMARY OF THE INVENTION

Objects of the present invention include systems for noninvasive monitoring of physiological variables of unrestrained (or restrained) non-human animals in a manner that is pain free and that cause little or no distress to the animal. A further object is accurate monitoring of physiological variables, many of which that could not heretofore be non-invasively monitored in unrestrained animals, in many diverse environments, such as in the laboratory, in limited test facilities, in the open, or even in freely ranging animals.

According to this invention, animals are monitored by providing animal garments into which are incorporated one or more physiological sensors. Various embodiments of the animal monitoring garments of this invention are preferably adapted to the physical and behavioral characteristics of individual animal species or even of individual animals. Most often the animal species to be monitored are often mammals, especially land-dwelling mammals. However, the invention can also be applied to other vertebrate species such as amphibians or reptiles, or generally, to any animal species having physiological variables that can be non-invasively monitored.

More specifically, embodiments of this invention are directed to such non-human mammalian species as: primates, e.g., monkeys, chimpanzees, orangutans, and so forth; rodents, e.g., rats, mice, guinea pigs, and so forth; to carnivores, e.g., dogs, domestic cats, wild cats, and so forth; to cattle, horses, elephants, and the like; to pigs; and to other animals. The species can be wild-type, common, purpose bred (e.g., Yucatan, Göttingen, and other mini-pigs), and the like

Monitoring garments for a selected species (or a selected individual animal) are sized and configured to fit members of that species in an unobtrusive manner and most preferably without causing distress or pain. Most preferably, monitoring can be done without requiring

that an animal be constrained or restrained. While wearing an appropriate monitoring garment, an animal should be able to carry out normal life activities and to have substantially normal mobility. However, if restraint is needed in a particular application, the garments preferably allow restraint using existing restraining devices and methods but without  
5     distorting monitoring data. Since continuous and/or long-term physiological monitoring is useful in many fields, it is preferably that monitoring garments are sufficiently tolerated so that they can be worn for extended periods of time, e.g., one or more hours, or one or more days, or one or more weeks.

Monitoring garments also preferably include adjustment and fixation devices to  
10     prevent, or minimize, self-removal by a monitored animal. Also, accurate operation of many sensors requires that they remain in a fixed position relative to the animal. Harnesses, halters, collars, belts and the like can improve fixation in a longitudinal direction along an animal's body. Snaps, zippers, elastic, Velcro and the like can improve fixation in a transverse by, e.g., allowing a garment to be snugly fit about an animal. Arrangement of adjustment and fixation  
15     devices preferably accommodates an animal's motions and activities without pressuring, abrading or otherwise injuring the animal's skin and/or subcutaneous tissues. However, adjustment and fixation devices should not rigidly attach to an animal or require invasive positioning procedures. Alternatively, a garment can be individually tailored for a particular animal.

20     Monitoring garments incorporate one or more non-invasive sensors which collect physiological data monitoring the animal. Sensors can be incorporated into garments in many ways, for example, by weaving, or knitting, or braiding into fabric from which a garment is constructed; or by being carried in, or mounted in, or attached to a finished garment. Sensors can also be glued, printed, sprayed and so forth onto inner or outer garment surfaces.

25     Preferred sensors collect data by being in appropriate contact with the animal without requiring applicants of ointments or creams to the animals skin. Preparation is preferably limited to shaving a portion of the animal skin. Example of preferred sensors include: a fabric or flexible electrocardiogram (ECG) electrode sewn on the inner surface of a garment so as to be in electrical contact with the animal's skin without need to conductive ointments;  
30     or one or more accelerometer attached to a snugly fitting garment so as to be sensitive to an animal's posture and motion, and so forth. Less preferably, a sensor accessible from the inside of a garment can require physical positioning or adhesion stuck to an animal's skin.

Many types of sensors can be incorporated in the monitoring garments of this invention. Commonly incorporated sensors include the following. A sensor, referred to herein

as a "size sensor", gathers signals responsive to indicia of subject sizes, such as lengths, circumferences, diameters, or equivalent or similar measures, of selected portions of the animal, such as the animal's torso, neck, extremities, or other body parts, or portions thereof. Inductive plethysmography described subsequently is a preferred technology suitable for size sensors. See, e.g., U.S. patents nos. 6,783,498 issued August 31, 2004, 5,331,968 issued July 26, 1994, and 4,834,109 issued May 30, 1989, all of which are incorporated herein by reference in their entireties for all purposes.

Size sensors positioned at one or more levels of an animal's trunk or torso, e.g., at an abdominal level and/or at a rib cage level, provide size data that can be usefully interpreted, according a two-component breathing model calibrated for a particular animal, to determine the animal's respiratory rates and volumes, e.g., tidal volumes. A garment fitted with such sensors can provide respiratory rate and volume data that has not previously been easily and non-invasively available. Size sensors at a mid-trunk or mid-thorax level can be responsive to cardiac and/or aortic pulsations; size sensors about one or more limbs can be sensitive to venous or arterial pulsations.

Garments can also include: electrocardiogram (ECG) electrodes and other cardiac activity sensors, e.g., fabric of otherwise flexible electrodes (see, e.g., U.S. provisional patent application no. (to be determined) filed April 10, 2006 and titled "PHYSIOLOGICAL SIGNAL PROCESSING DEVICES AND ASSOCIATED PROCESSING METHODS" with attorney docket no. 85167-75289, which is incorporated herein by reference in its entirety for all purposes); sensors for posture and activity, e.g., one or more accelerometers sensitive to an animal's orientation with respect to gravity and to an animal's accelerations accompanying activity; temperature sensors, e.g., thermistors; blood oxygen levels, e.g., pulse oximeters, electrodes for cerebral electrical activity, muscle electrical activity including activity of ocular muscles; and the like.

This invention also includes electronic circuitry variously housed that cooperate in a sensor specific manner with sensors incorporated into a monitoring garment to retrieve, process and store, and optionally display physiological data from a monitored animal. In preferred embodiments, such electronic element is a single portable data unit (PDU) (in one or two housings) that is in the vicinity of a monitored animal. A PDU serves to operate sensors, to retrieve sensor data, and to process retrieved data at least so that it can be digitally temporarily stored and/or transmitted for possible use by systems external to the immediate environment of the animal. Temporary data storage can be in flash memory or on magnetic

media, e.g., hard drives, and data so stored can be transmitted by removing the flash memory or hard drive. Immediate transmission can be by wired or wireless links.

In these embodiments, PDUs can be carried on and by an animal preferably and operate autonomously so that the animal need not be restrained by data, power or other types of cables between the PDU and outside systems. Such PDUs should be sized and configured not to hinder the animal's activities and not to be obtrusive or significantly apparent to the animal. Such PDUs are accordingly preferably sized and configured to fit into a pocket or a recess of the monitoring garment itself, or to be carried a pack or a backpack outside of the garment (but not accessible by the animal) or otherwise carried. Such PDUs preferably either store data, e.g., for later analysis, or wirelessly transmit data, e.g., for real-time analysis. For example, animal monitoring facility can have a central collection system in communication with multiple monitored animals with such PDUs.

Alternatively, PDUs can be connected to external systems by a wire or cable; the animal can then move freely but only within a specified area. Such PDUs do not need to function autonomously. For example, their functions can be limited to interfacing with sensors and sending retrieved sensor data to external circuitry that resides away from an animal for storage, retransmission, processing, or the like.

PDUs carried by an animal can be connected to their controlled sensors incorporated into a garment worn by the animal in various manners. In one alternative, sensors can be linked to PDUs by wires and/or cables, all of which are preferably routed in a single physical data cable. In this embodiment, the PDU function can be performed by circuitry in two or more housing all linked by cables. In another alternative, sensors can be linked to the PDU by wirelessly means using, e.g., Bluetooth or similar local transmission technologies.

This invention also includes external computer systems that can receive animal monitoring data from the PDUs, process received data, display processed data, and store raw and/or processed data. These computer systems can be variously configured according to the processing needs of an animal monitoring application, and they can range from a single PC-type computer suitable for monitoring a limited number of animals to server-type distributed systems for monitoring a larger number of animals. These systems are generally located external to the immediate animal environments and may be local or remote to the animal monitoring facility itself and perform methods carrying out the following functions. The external systems can be format and display raw and/or processed sensor data and can also archive raw and/or processed data.

Sensor data can be processed by the external systems and/or also by the PDUs. Sensor-specific processing functions can be assigned to these components according to their relative capabilities and according to processing requirements of data retrieved from various sensors. Data from some types of sensors needs can require more extensive processing. For  
5 examples, respiratory signals from size sensors are preferably calibrated and combined according to a calibrated two-compartment breathing model in order to provide respiratory volumes. Respiratory rates and further respiratory events can then be extracted from the processed respiratory volume data. Heart beat occurrences and heart rate can be extracted from raw ECG signals by applying known signal processing methods. Accelerometer data is  
10 preferably processed to determine animal posture, e.g., as reflected in accelerations of lower temporal frequencies that likely arise from an animal's orientation with respect to gravity, and to determines animal activity, e.g., as reflected in higher-temporal-frequency accelerations that likely arise from an animal's movements or activities. Data from other types of sensors needs less extensive processing, e.g., limited to filtering to limit noise and artifacts. Such data  
15 includes, for example, temperature signals, cerebral and/or muscular electrical activity, and the like.

Although this invention is usefully applied during the course of pharmaceutical testing, it will be appreciated that non-invasive monitoring of (optionally) unrestrained animals has numerous other applications. For example, this invention can usefully monitor laboratory  
20 mammals of all sizes during basic and applied research. It is useful throughout the fields of veterinary medicine and surgery, for example for continuous physiological monitoring during veterinary care of animal patients, from pet mammals to commercial mammals (e.g., cattle), and also in testing veterinary pharmaceuticals. This invention is also useful in general animal training and monitoring programs. It can be used for training racing dogs and horses. It can  
25 be used in zoos for monitoring animals in need to veterinary attention, for animal research, or for other purposes.

This invention also includes computer readable media on which the methods are encoded.

Specific embodiments of this invention will be appreciated from the following detailed  
30 descriptions and attached figures, and various of the described embodiments are recited in appended claims.

### BRIEF DESCRIPTION OF THE DRAWINGS

The present invention may be understood more fully by reference to the following detailed description of preferred embodiments of the present invention, illustrative examples of specific embodiments of the invention, and the appended figures in which:

- 5 Figs. 1A-D illustrate embodiments of animal monitoring garments;  
Figs. 2A-E illustrate views of an exemplary monitoring garment for a monkey;  
Figs. 3A-B illustrate exemplary monitoring data obtained from a monkey;  
Fig. 3C illustrates an embodiment of a monitoring garment for a monkey;  
Figs. 4A-B illustrate exemplary monitoring data obtained from a beagle;  
10 Fig. 4C illustrates an embodiment of a monitoring garment for a dog;  
Figs. 5A-B illustrate exemplary monitoring data obtained from a non-human primate;  
Figs. 6A-B illustrate exemplary monitoring data obtained from a non-human primate;  
and  
Figs. 7A-B illustrate exemplary monitoring data obtained from a non-human primate.

### 15 DETAILED DESCRIPTION OF THE PREFERRED EMBODIMENTS

The present section describes in more detail certain preferred but non-limiting embodiments of this invention. Headings and legends are used here, and throughout this application, for clarity only and without intended limitation.

Contrary to expectations, the inventors of this application have discovered that  
20 selected technologies known to be useful for monitoring ambulatory human subjects are also surprisingly successful for monitoring unrestrained (and/or restrained) non-human subjects. In particular, size sensors incorporated in a garment for an animal subject in a manner so that they are appropriately positioned on an animal subject wearing the garment provide useful and accurate respiratory and cardiac data. Further, the inventors have observed that selected  
25 secondary sensors, incorporated in such a garment many, return data useful for supplementing and interpreting size sensor data. These secondary sensors are also known for use in human monitoring. Accordingly, described herein are sensor technologies and preferred garment structures incorporating sensors based on the preferred technologies.

### PREFERRED SENSOR TECHNOLOGIES

30 Monitoring garments of this invention preferably include one or more size sensors, although certain embodiments of this invention include monitoring garments without any size sensors. Useful size sensors are known that are based on diverse technologies including:

magnetometers; piezoelectric strain gauges; magnetic or capacitive strain gauges; electrical impedance and/or activity at the body surface; optical techniques including interferometry; pressure-based plethysmography, ultrasonic measurements; and so forth. See, e.g., U.S. patent no. 5,373,793 issued October 11, 1994.

5 Preferred size sensors are based on inductive plethysmography ("IP"), and especially preferred are IP sensor configured and arranged to measure body wall size changes due to respiration (respiratory IP or "RIP"). IP and RIP technology for human monitoring is known. Here a brief summary is provided.

10 IP technology responds to sizes by measuring the self-inductance of a conductor or of a conductive loop (metallic or non-metallic) arranged to snugly encircling an anatomic portion to be measured. Conductive loops can be directly incorporated (as by weaving, sewing, knitting or the like) into the fabric of a monitoring garment, and the garment designed to fit snugly so that loop sizes accurately reflect the sizes of the anatomic portion being measured. Alternatively, IP sensor conductors or conductive loops can be incorporated into bands which  
15 are affixed to garment by sewing, weaving, and the like. To measure respiratory motions, a RIP sensor should be at the level of the chest or thorax. A second RIP sensor at the level of the abdomen is preferred. In general, one or more RIP sensors should be positioned on an animal so the major components of respiration-induced body wall motion is sensed. For monkeys and smaller animals, sensitivity is increased if an IP conductive filament encircles  
20 the body part to be measured two or three or more times, or alternatively, is duplicated, e.g., by coursing back and forth in a body region.

IP signals are generated by oscillator/demodulator modules linked to variable-inductance IP sensors. As inductance changes, oscillator frequency changes. The frequency changes are demodulated and digitized. The digital data encoding the variable oscillator  
25 frequency is analyzed to determined physiological events, e.g., respirations or heartbeats. Advantageously, prior to monitoring, RIP or other IP signals are calibrated during a period of relative to more accurately reflect relative or absolute lung volumes. The oscillator/demodulator circuitry is preferably located near to the RIP sensor, e.g., in a PDU carried by the animal.

30 IP and RIP technologies are described in the following U.S. patents and applications. The inventors have discovered that selected portions of this technology is useful for monitoring non-human animals. See, e.g., U.S. patent nos. 6,551,252 issued April 22, 2003; 6,047,203 issued April 4, 2000; 6,341,504 issued January 29, 2002; 5,331,968 issued July 26, 1994; 5,301,678 issued April 12, 1994; and 4,807,640 issued February 28, 1989. Also see,

e.g., U.S. patent application U.S. application nos. 10/822,260; and 11/233,317 filed September 21, 2005. These U.S. patents and applications, and other references throughout this application, are incorporated herein in their entireties for all purposes.

5 ECG electrodes preferably are flexible and require little if any conductive pastes and the like in order to establish electrical contact with a monitored subject. Such electrodes can be constructed from known conductive fabrics. See, e.g., U.S. patent application no. 60/730,890 filed October 26, 2005. Accelerometer sensors are preferably miniaturized MEMS-type devices sensitive to three components of acceleration

### **PREFERRED MONITORING GARMENT STRUCTURES**

10 Monitoring garments described here in more detail are directed to monitoring monkeys, dogs, and horses. However, this invention can readily be adapted a wide range mammalian species including, e.g., mice, rats, rabbits, ferrets, guinea pigs, special bred pigs (including species of Yucatan and Göttingen mini pigs), common swine, cats, primates, sheep, cows and other cattle, and the like. Adaptation involves tailoring a garment to species  
15 sizes, providing attachment and fitting devices that hold the garment snugly and prevent self-removal, and calibrating sensor data to reflect species physiology. Attachment and fitting devices can adapt structures known in the art, e.g., harnesses, collars, halters, and the like. For small animals, more sensitive sensors are advantageous (as has been described for IP sensors). Land-dwelling vertebrates and non-mammalian species generally can be monitored if the  
20 species members are capable of wearing a monitoring garment, and particularly if they produce body wall motions indicative of useful physiological parameters.

In more detail, the monitoring garment and/or PDU and/or PDU carrier are adapted to the characteristics and behavior of the animal species to which they are directed. Garment configurations, e.g., shirt-like, or vest-like, or band-like, or the like, should be acceptable to  
25 the animal. For example, they should not obstruct the animal activities, nor unnecessarily limit the animals seeing, or hearing, or smelling, and other senses that might be vital to the species, nor cause body temperature abnormalities, and the like. Different animals scratch, claw, chew, pull, rub, and tear (especially monkeys), bite and the like, and the garment and PDU carrier should be resistant to the animal's natural abilities. Animals also run, jump,  
30 swing, hit objects, play, and the like, often quite roughly, and the garment and PDU carrier should be sufficiently mechanically strong and shock resistant so not to be damaged and even to continue operating during the animal's natural activities. The monitoring garment should

also permit animal restraint by standard methods or procedures should such restraint be otherwise necessary.

Additional protection is preferable for garments that have externally accessible features, e.g., adjustments, zippers, flaps, pockets, electrical leads, and the like, and for  
5 garments worn by species that are sufficiently dexterous to be able to access and manipulate a garment, e.g., primates. External features are more susceptible to being deranged during the normal activities of any animal. They may also be accessible to the animal and damaged by pulling, chewing, biting, and so forth. One preferred form of further protection is an over-garment covering all of part of the monitoring garment and having a substantially uniform  
10 texture and without any externally accessible features. An over-garment preferably smoothes external spatial structures of the monitoring garment, such as bumps, ridges, recesses and so forth, so that they are less, or not at all, externally apparent to the animal's visual and/or tactile senses. The over-garment should be sufficiently tough not to be penetrated by the animal.

Embodiments of monitoring garments for a variety of animals are now described with  
15 reference to Figs. 1A-D. Fig. 1A illustrates a vest-like garment 3 for un-restrained monkey 1. This garment incorporates two ECG electrodes 7 (only one is visible) in contact with the monkey's skin. In a more preferred embodiment, the illustrated cutout is absent, and ECG electrodes are mounted directly on the inside of the garment. This garment also incorporates two size sensor bands 5 returning data reflective of the sizes of the monkey's abdomen and rib  
20 cage that are useful for determining respiratory rates and volumes using a two-compartment breathing model. Longitudinal fasteners 9 such as zippers and/or Velcro strips join the garment along the ventral midline.

Fig. 1B illustrates a different view of a more preferred vest-like monitoring garment 4  
25 for monkey 10 lacking cutouts for ECG electrodes. Instead, ECG electrodes are positioned inside the garments in contact with the monkey. Longitudinal fasteners 9 along the garment's ventral midline are more clearly apparent herein.

Not illustrated but preferred, is an over-garment protecting the monitoring garment itself from the monkey. Monkeys are intelligent, dexterous and clever animals that have particular tactile sensitivity to small shapes and textures. Therefore, the over-garment  
30 preferably presents a uniform texture to the monkey's tactile senses and makes less prominent any spatial structures in the underlying garment, such as may be presented by bands, electrical leads, adjustments, fastenings, and so forth. Further, the monitoring garment, the accompanying PDU and/or PDU case or housing, and an optional over-garment should be

sufficiently tough and resistant so that a monkey's often rough and sudden activities will not damage the monitoring components.

Fig. 1C illustrates a more shirt-like monitoring garment 13 for un-restrained dog 11. This garment extends relatively further in the longitudinal direction along the dog's torso than does the more vest-like garment of Fig. 1A. This provides longitudinal stability and fixation during the dog's normal activities. This garment also includes two size sensor bands 15 suitable for obtaining data for respiratory rates and volumes. The garment is fastened by fastener 17 along the ventral midline. ECG electrodes are mounted under the garment in contact with the dog and not externally visible in garment cutouts. An over-garment (also not illustrated) is also preferred for dog monitoring

The garment of Fig. 1C includes backpack 19 which carries the PDU safely on the dog's back out of the dog's reach. A data cable not illustrated and not accessible by the dog links the PDU to the garment sensors. It can be routed along and under an upper seam of the garment to the ventral midline along which it connects to sensors and to sensor electronic modules.

Fig. 1D illustrates a band-like garment for un-restrained horse 23. This garment includes band 25 incorporating one or more size sensors for monitoring the horse's respiratory rate and optionally respiratory volumes. The band may also incorporate ECG electrodes in contact with the horse ventrally. This band-like garment can be secured and fixed on the horse in a variety of ways. Illustrated is harness arrangement 27 connecting to the monitoring garment with dorsal strap 29a and ventral strap 29b and anchoring the garment with respect to the horse's neck. Alternatively, band 25 may be displaced to an abdominal position and the garment may include a second band in the vicinity of the horse's front legs. Thereby, the band is relatively fixed so that both rib cage and abdominal sizes may be obtained for more accurate respiratory volumes.

Alternatively, a horse can be provided with a vest-like or shirt-like monitoring garment incorporating sensors. A preferred such shirt-like garment has a relative configuration and size similar to garment 13 illustrated for dog 11 (Fig. 1C) but of an appropriately larger scale.

Figs. 2A-E illustrate several views of an actual monitoring garment for a small primate, particularly a monkey. Twelve inch ruler (57 in Fig. 2A) provides a scale for the garment. Fig. 2A is a view of the outside of an extended garment. Rostrally are arm holes 35a and 35b with shoulder straps 37a and 37b. Moving caudally, first size sensor band 39 carries Velcro adjustments 41a and 41b. By adjusting these straps, size sensor band 39 can be snugly configured about monkeys of differing sizes. Second size sensor band 43 carries three

Velcro adjustments 45a, 45b, and 45c by which this second band can also be snugly configured about a monitored monkey. The garment is substantially fixed longitudinally and transversely on the monkey by cooperation of snug size sensor bands and the shoulder straps. Thereby, sensors can be relatively fixed and repeatedly placed with respect to the monkey's  
5 body so that data is accurate and consistently interpretable. Running longitudinally between the two straps are longitudinal adjustments 47a, 47b, and 47c having drawstrings with spring clips for configuring the garment so that the size sensor bands do not move relative to each other in a longitudinal direction during the monkey's normal activities. Other embodiments employ other combinations of these and other adjustment devices suitable for snugly  
10 configuring garments and achieving accurate fixation of sensors relative to the monkey.

A garment is fastened onto a monkey by first closing zipper fastener 49 that links the left and right edges of the garment. Next, right flap 51 is fastened to a corresponding left flap by zipper fastener 53. These flaps form a protected longitudinal tunnel-like arrangement which can hold electronic modules that are advantageously located close to their respective  
15 sensors. In the case of IP size sensors, electrical leads 55a and 55b emerging from under longitudinal flap 51 connect to oscillator/demodulator electronic modules placed in this tunnel. A data cable runs longitudinally along the tunnel linking these electronic modules and other sensors to the PDU carried outside the garment. Alternatively, the data cable will link to a PDU pocket if the PDU is sized so that it can be carried in a pocket of the garment.

20 Fig. 2B is a view of the inside of an extended garment. Arm holes 35a and 35b, shoulder straps 37a and 37b, and fasteners 49 and 53 are visible. Pocket-like arrangements 61a, 61b and 61c are for holding sensors not directly woven, knitted, stitched, or otherwise directly incorporated into the garment. Fig. 2C is a detail view of the inside of sensor pocket 61c illustrating access openings 63a and 63b.

25 Fig. 2D is a right lateral view of a fastened garment as it would be worn by a monkey illustrating how the garment encloses the animal's torso. Fig. 2E is a similar left lateral view of a fastened garment.

Sensor processing methods are preferably specifically calibrated for monitoring specific animals and programmed in a convenient computer language, such as assembly  
30 language, C, or C++. This code can be compiled into executable form and stored on a computer readable medium for loading into a processing system of this invention. In alternative embodiments, the methods are implemented in firmware, e.g., an FPGA, and configuration instructions can be similarly stored on a computer readable medium. Accordingly, the present invention also includes program products including such computer

readable media, and systems for processing the methods which receive data from the monitoring garments of this invention

## EXAMPLES OF THE INVENTION

### Example 1

5 Figs. 3A and 3B illustrate processing of monitoring data from a monkey obtained with the monitoring garment of Fig. 3C, which has substantially similar features to the monitoring garment embodiment of Figs. 2A-E. The monitoring garment of Fig. 3C also incorporates the electrical circuitry and configurations that are described in more detail in U.S. Patent No. 6,551,252, which is expressly incorporated herein for all purposes in its entirety thereto.

10 Fig. 3A illustrates one minute of processed respiratory and accelerometer data along with an ECG signal also obtained using the monitoring garment. Band 85 illustrates processed accelerometer data, and shows that during this minute of data the monkey engaged in little activity and made no posture changes. Band 81 illustrates the monkey's tidal volume during this period of substantially little activity, and shows that the monkey was breathing at a regular rate with regular tidal volumes. Band 83 illustrates ECG data and shows a regular heart beat and little or no signal artifact.

15 Fig. 3B illustrates three minutes of data. The processed accelerometer data, band 91, indicates that at time 93 that the monkey made a change of posture and that at time 95 the monkey was briefly active. Band 89 illustrates the ECG data obtained, and band 87 illustrates the monkey's tidal volume, but a vertical scale much reduced from that of Fig. 3A. Aspects of the data displayed in bands 87 and 89 can be interpreted in view of processed accelerometer data in band 91. For example, respiratory data in band 87 illustrates that the DC volume calibration of the monkey's respiratory volume curve changed 97 along with the monkey's change of posture. Such calibration changes commonly follow posture changes, because posture significantly affects mechanical relationships in the chest and the chest's orientation with respect to gravitational acceleration. Also, both the respiratory band and the ECG band illustrate a brief period of motion artifact, 99 and 101, respectively, in association with the monkey's motion revealed at 95 in the accelerometer trace.

### Example 2

30 Figs. 4A and 4B illustrate processing of monitoring data from a beagle obtained with a monitoring garment of Fig. 4C, which has substantially similar features to the monitoring garment adapted to fit a monkey shown in Fig. 3C. Fig. 4A illustrates five minutes of processed data including tidal volume ( $V_t$ ), ECG, heart rate (HR), and accelerometer (ACC)

data, and an index of respiratory sinus arrhythmia (RSA). By measuring the combination of respiratory and ECG signals in an unrestrained animal, clear identification and evaluation of periods of 'pure' ECG, i.e., those unaffected by the respiratory cycle, can be made. Utilization of these stable periods for the analysis of the timing components of the ECG signal (e.g., Q-T interval) provides investigators an opportunity for greater precision thereof than is currently possible.

Specifically, during periods of central apnea (cross-hatched areas where the tidal volume trace is substantially flat), which are common in sleeping canines, the ECG signal reflects purely the electrical activity of the myocardial muscle absent the impact of transient transmural pressure gradients associated with breathing. As seen in Fig. 4A, and in more detail in Fig. 4B, the animal's heart rate during these apneic periods is very stable and its ECG is constant. It is also worth noting the variability in the animal's heart rate prior to these apneic periods, such variability associated with the animal's breathing cycle and resulting in beat-to-beat differences in ECG. This is known as respiratory sinus arrhythmia (RSA).

### 15 Example 3

Continuous monitoring of non-human animals primates (NHP), enables identification of behavioral and activity patterns that indicate when such an animal may be agitated or experiencing stress. For example, such patterns may indicate that an animal, which was once previously thriving in the environment with other animals, is beginning to manifest negative behavior that could result in their removal from a research colony. This inappropriate behavior is broadly termed 'stereotypical' behavior, and ranges from repetitive movements to obsessive behaviors, and at the extreme, severe self-injurious behavior. Animals who display stereotypical behaviors are not effective for research and are typically removed from the cohort of available animals. Moreover, if they don't positively respond to environmental and stimuli changes, they cannot be further used for research in the future.

Physiological data collected with the monitoring garment of Fig. 3C can identify abnormal movement patterns as well as the presence of repetitive/obsessive type behaviors in non-human animals. For example, Figs. 5A and 5B illustrate normal and abnormal, respectively, activity and rest patterns on an animal over a period of over 20 hours.

30 In Fig. 5A, the overnight, "Lights Out" period is about 12 hours in length. The first half contains multiple discreet bouts of activity and rest as identified in the ACC trace, the Vt trace, the median breath rate (mBr/M) trace, and the median heart rate (MHR) trace. Later in the night, the animal appears to rest quietly for approx. 6 hrs (identified in the ACC, Vt,

mBr/M, and MHR traces). During the Lights On period, there are distinct periods of activity with intervals of rest. The cross-hatched "Cage" period during the Lights On period is when cage cleaning occurred in primate room, and the narrower cross-hatched period within the Cage period is when the monkey's own cage was being cleaned.

5 In Fig. 5B, the overnight, "Light Cycle: Off" period is also 12 hours in length. During this time, the animal's activity is reduced, but there does not appear to be any quite rest intervals compared to the data of Fig. 5A. The animal exhibits constant movement throughout the night, as shown in the ACC trace, as well as unstable physiological conditions, as shown in the Vt, mBr/M, and MHR traces. Towards the end of the Lights Off period, there is about  
10 50 min period of quiet rest. During the wake period before Lights Off, the animal is extremely active. When the lights come back on, the animal's activity shows very little difference compared to the previous 12 hours (i.e., overnight).

Fig. 6A illustrates the physiological data of a healthy animal collected over a period of 5 minutes. As seen in the median accelerometer trace (AccM), the animal exhibits a normal  
15 pattern of activity that is typically irregular in pattern and timing. Comparing Fig. 6A with the 5 minute activity trace of Fig. 6B of an animal displaying stereotypical behavior, it is clear from the circled portions that the animal exhibits a series of repetitive, bi-phasic movements that is indicative of such abnormal behavior.

Figs. 7A and 7B show another example of the physiological data that is indicative of  
20 stereotypical behavior. In Fig. 7A, the animal displays normal intervals of activity, followed by relatively long periods of rest after lights are turned out in the environment. The animal appears to rest physiologically for almost 6 hours during the entire 12 hour Lights Out cycle (i.e., the rest period is shown from about the middle of the trace all the way to the end of the Lights Out period). The animal also exhibits distinct intervals of activity and rest in the period  
25 before quieting down.

In contrast, Fig. 7B shows the physiological data of an animal displaying stereotypical behavior, characterized in a constant level of activity long into the Lights Out period with relatively little rest. The animal only gets about 60 minutes of physiological rest (cross-hatched period). During this time, the respiratory tidal volume trace, breathing frequency, and  
30 heart rate stabilize, and the median accelerometer trace shows very little movement. When the animal wakes, however, all of the traces regain their previous characteristics. Such physiological data may also correlate fairly well with, or can be used to identify the presence and/or change in the degree of physiologic stress experienced by the animal.

As shown in the data provided in Figs. 7A and 7B, a garment substantially similar to that illustrated in Figs. 2A-E can also be used to infer sleep time and/or periods of quiet physiologic rest using variability and absolute level of various physiologic data streams. This data can provide valuable information for improving animal care and husbandry, for example, in veterinary environments.

These examples demonstrate that the monitoring garments and systems of this invention obtain reliable monitoring data that can be processed and consistently interpreted to provide useful physiological and behavioral information.

The invention described and claimed herein is not to be limited in scope by the preferred embodiments herein disclosed, since these embodiments are intended as illustrations of several aspects of the invention. Any equivalent embodiments are intended to be within the scope of this invention. Indeed, various modifications of the invention in addition to those shown and described herein will become apparent to those skilled in the art from the foregoing description. Such modifications are also intended to fall within the scope of the appended claims.

A number of references are cited herein, the entire disclosures of which, if not previously incorporated by reference, are hereby explicitly incorporated herein, in their entirety, by reference for all purposes. Further, none of these references, regardless of how characterized above, is admitted as prior to the invention of the subject matter claimed herein.

Headings are used hereon for clarity and convenience only and without any intended limitation.

## THE CLAIMS

What is claimed is:

- 5                   1.       An apparatus for monitoring members of a non-human animal species, comprising:
- a monitoring garment to be worn by said member animals that is adapted and configured to the size and behavior of said member animals and that permits said member animals to perform normal activities;
- 10                   one or more sensors incorporated into said garment for sensing physiological functioning of said member animals; and
- a portable data unit that is adapted and configured to be carried on said member animals and that activates said sensors and retrieves physiological data from said sensors without wired external connection.
- 15                   2.       The apparatus of claim 1, wherein said animal species is selected from the group consisting of land-dwelling amphibians, land-dwelling reptiles, and land-dwelling non-human mammals, wherein said land-dwelling non-human mammals include primates, monkeys, chimpanzees, orangutans, rodents, rats, mice, guinea pigs, carnivores, dogs, domestic cats, wild cats, cattle, horses, elephants, wild-type pigs, common swine, and purpose
- 20                   bred mini-pigs.
3.       The apparatus of claim 1, wherein said monitoring garment further comprises one or more attachment and/or fitting devices to adjust said monitoring garment to an individual member animal.
- 25                   4.       The apparatus of claim 2, wherein said attachment devices comprise a zipper, a Velcro portion, a drawstring, a button, wherein said fitting devices comprise an one or more elastic portions.
- 30                   5.       The apparatus of claim 1, wherein said monitoring garment further comprises a strap configured to fit about the torso of said member animals.
6.       The apparatus of claim 1, wherein said monitoring garment further comprises:

a principal portion sized and configured to fit in a shirt-like fashion around the torso of a member animal; and

one or more open portions for accommodating and encircling at least one extremity of a member animal when said garment is worn by said animal so that motion of the garment relative to the animal is limited.

7. The apparatus of claim 6, further comprising two open portions for accommodating both fore extremities of a member animal when said garment is worn by said animal.

8. The apparatus of claim 6, further comprising one or more attachment and/or fitting devices for securing the principal portion of the monitoring garment around the torso of a member animal.

9. The apparatus of claim 1, wherein said monitoring garment further comprises at least one pocket for carrying said portable data unit on or by said member animal so that said animal can autonomously perform normal activities during monitoring.

10. The apparatus of claim 1, wherein said portable data unit further temporarily stores retrieved sensor data and/or wirelessly transmits retrieved sensor data.

11. The apparatus of claim 1, wherein said sensors comprise one or more sensors responsive to sizes of portions of said member animals including a size of a rib cage and/or to a size of an abdomen.

12. The apparatus of claim 11, wherein at least one of said size sensors is based on inductive plethysmographic technology.

13. The apparatus of claim 1, wherein said sensors comprise an accelerometer sensitive to posture and/or activity.

14. The apparatus of claim 1, wherein said sensors comprise one or more of an electrocardiogram electrode, a temperature sensor, a blood oxygen level sensor, an electrode for cerebral electrical activity, an electrode for muscle electrical activity, or an electrode for ocular muscles electrical activity.

15. An apparatus for monitoring a non-human animal, comprising:

a monitoring garment to be worn by said member animals that is adapted and configured to the size and behavior of said member animals and that permits said member animals to perform normal activities;

5 one or more sensors incorporated into said garment for sensing physiological functioning of said member animals;

a portable data unit that is adapted and configured to be carried on said member animals and that activates said sensors and retrieves physiological data from said sensors without wired external connection; and

10 a computer system operatively coupled for data transfer to said portable data unit for displaying said retrieved physiological data.

16. The apparatus of claim 15, wherein said operative coupling comprises computer readable media written by said portable data unit and read by said computer system and/or a wireless communications link.

15

17. The apparatus of claim 15, wherein said displayed physiological data comprises indicia of respiratory functioning and/or indicia of cardiac functioning and/or indicia of posture and/or activity.

20

18. A method for determining a selected physiological and/or behavioral pattern present in a non-human animal, comprising:

fitting the non-human animal with a monitoring garment of claim 1;

retrieving one or more of cardiac data, respiratory data, or activity data from said monitoring garment when worn by said non-human animal; and

25

evaluating said retrieved data to assess the likelihood that said selected physiological and/or behavioral pattern are present in a non-human animal.

30

19. The method of claim 18 wherein said selected physiological and/or behavioral pattern comprises patterns of cardiac activity, and wherein said cardiac activity patterns are determined from retrieved cardiac data that occurs concurrent with a period of central apnea, said central apneic periods being indicated by retrieved respiratory data.

35

20. The method of claim 19, wherein said determined cardiac activity patterns comprise a baseline heart rate and/or one or more timing components of an ECG signal.

21. The method of claim 18 wherein said selected physiological and/or behavioral pattern comprises dysphoric emotional states, and wherein said dysphoric emotional states are indicated by abnormal patterns of activity occurring in association with particular physiological functioning.

22. The method of claim 21, wherein said non-human animal is normally active during the day, and wherein said abnormal activity patterns comprise prolonged activities occurring during periods of darkness.

23. The method of claim 21, wherein said abnormal activity patterns comprise periodic repetitions of one or more patterns of stereotypical activities and/or postures, each repetition in association with said particular physiological functioning.

24. The method of claim 21, further comprising providing said non-human animal evidencing dysphoric emotional states with a new physical and/or social environment.

25. The method of claim 21, further comprising assessing the degree of dysphoria from the magnitude and/or the frequency and/or the duration said abnormal activity patterns.

26. The method of claim 21, further comprising detecting periods of physiologic rest in said non-human animal, wherein periods of physiologic rest are indicated by reduced average levels of physical activity occurring concurrently with reduced temporal variation of said retrieved physiological data.

27. The method of claim 26, wherein said non-human animal is normally active during the day, and wherein said patterns indicative of physiologic rest occur during periods of darkness.

28. The method of claim 26, further comprising determining the relative duration of physiologic rest in said non-human animal.

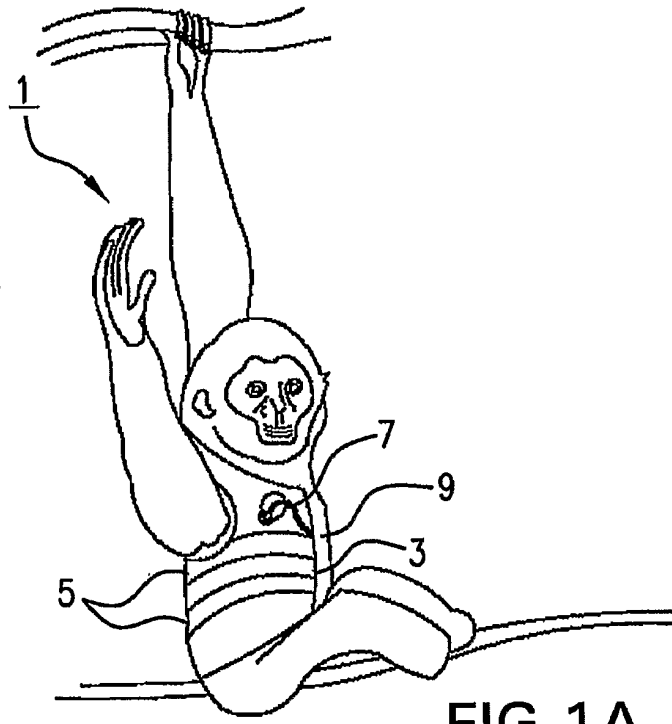

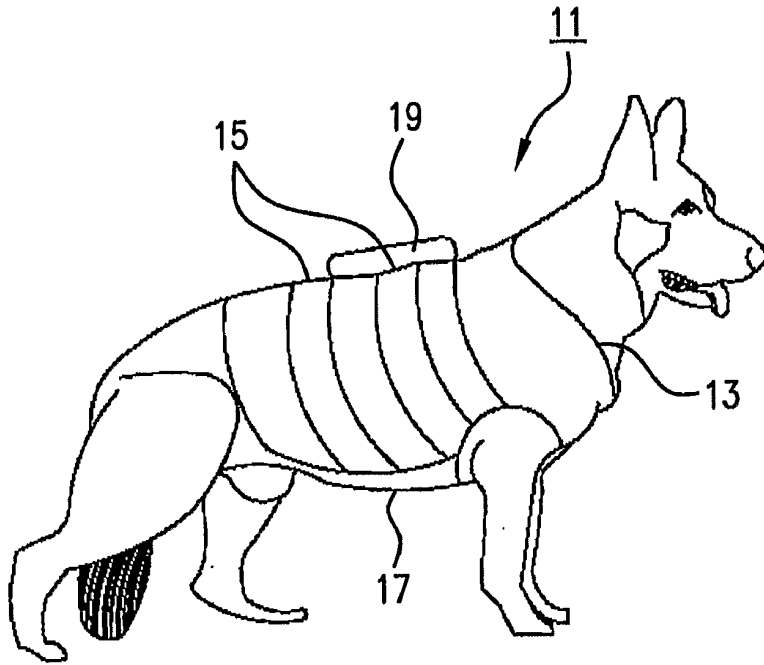

FIG. 1C

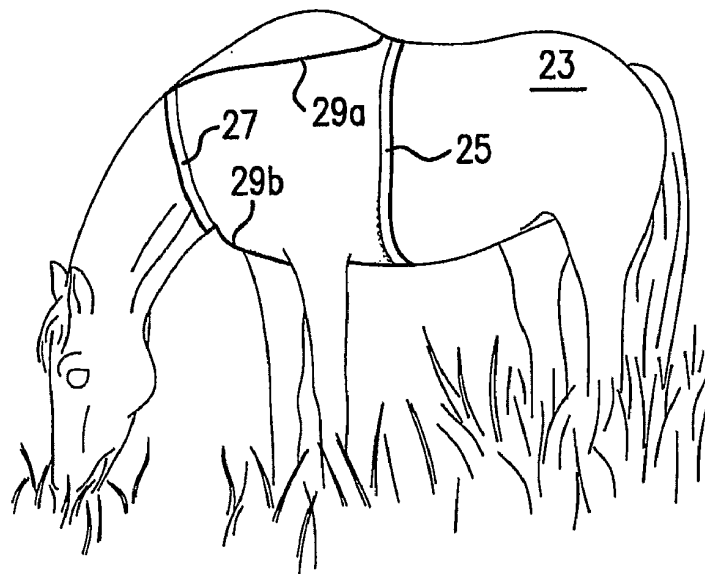

FIG. 1D

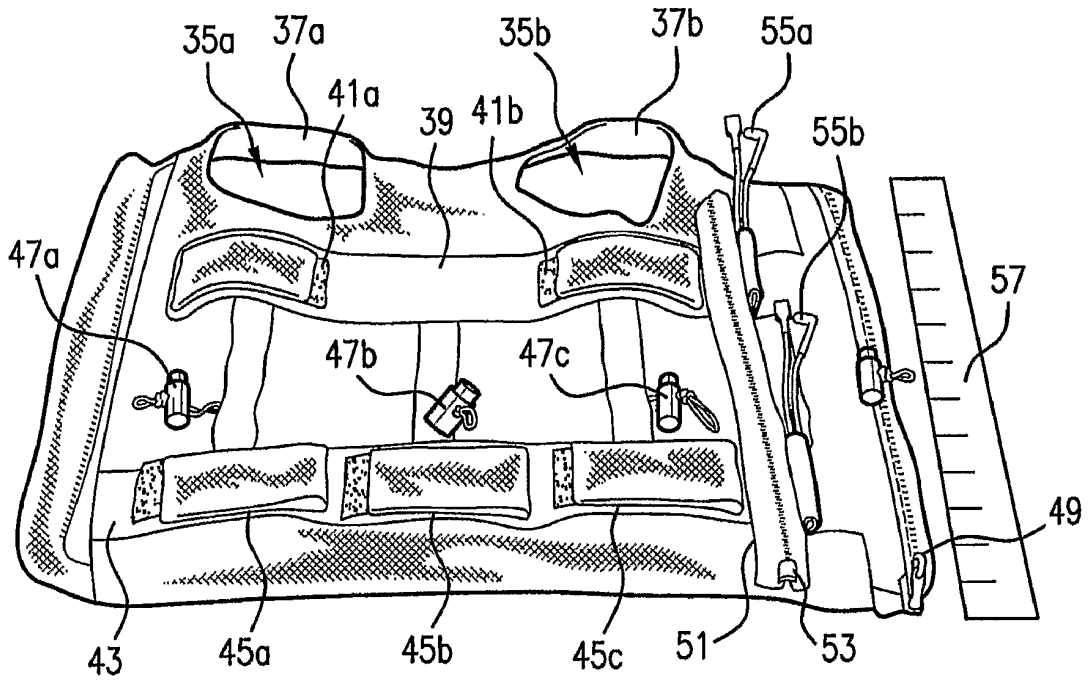

FIG. 2A

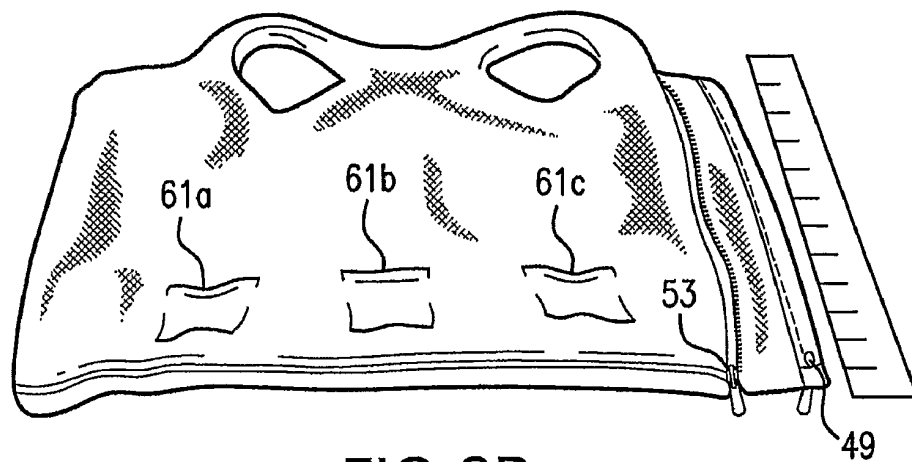

FIG. 2B

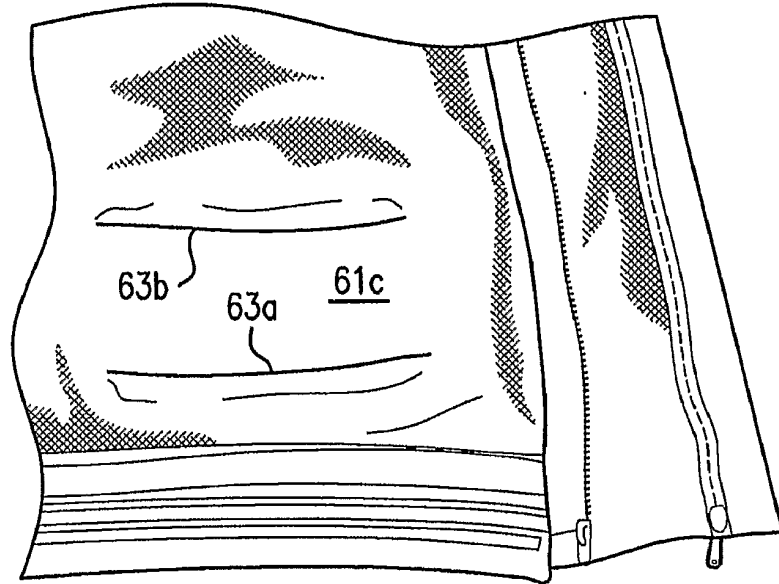

FIG. 2C

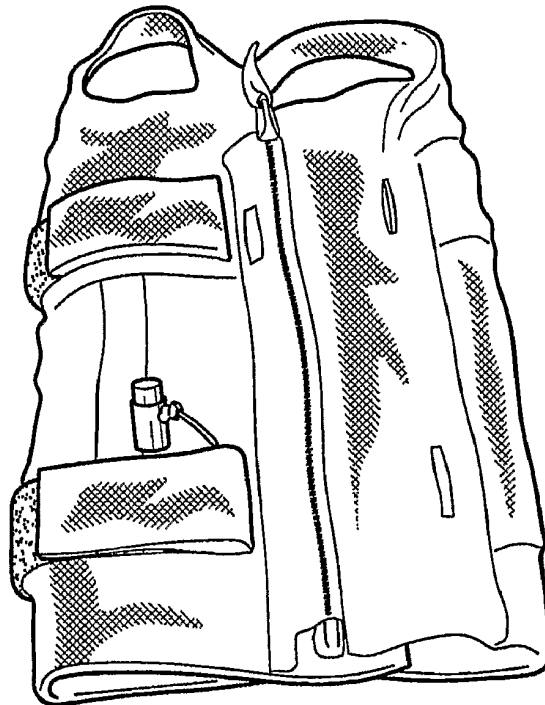

FIG. 2D

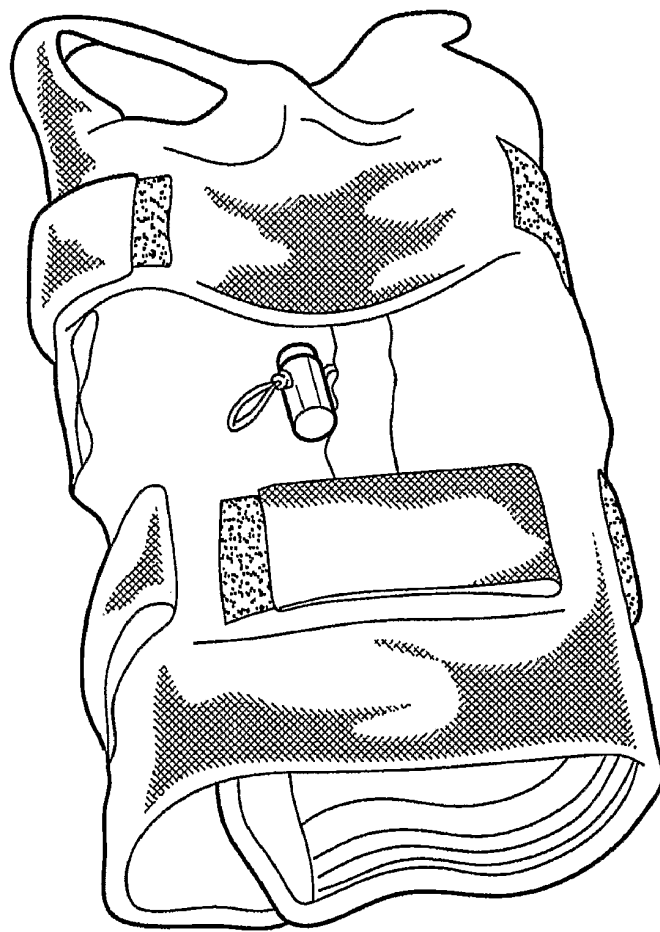

FIG. 2E

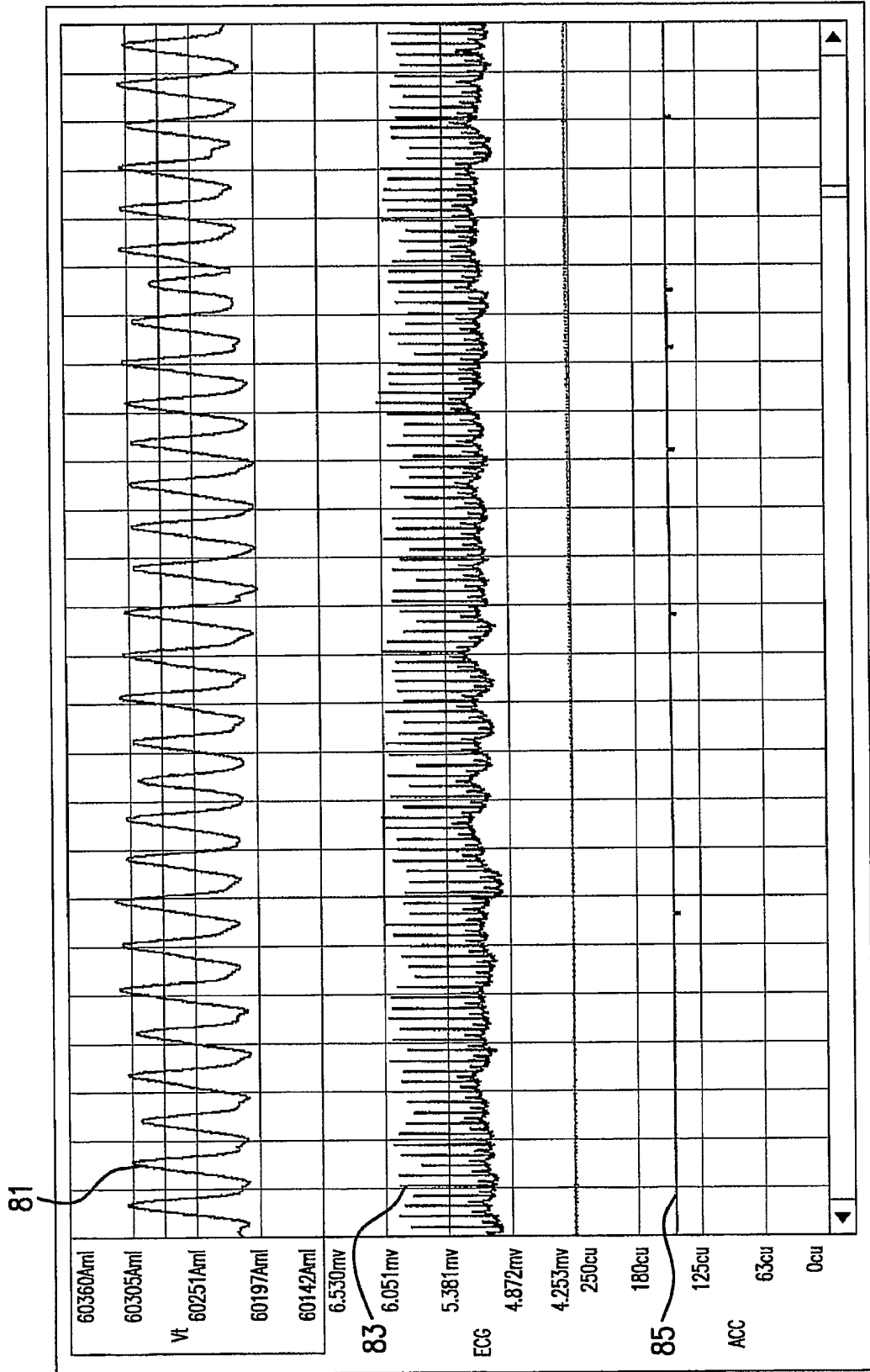

FIG.3A

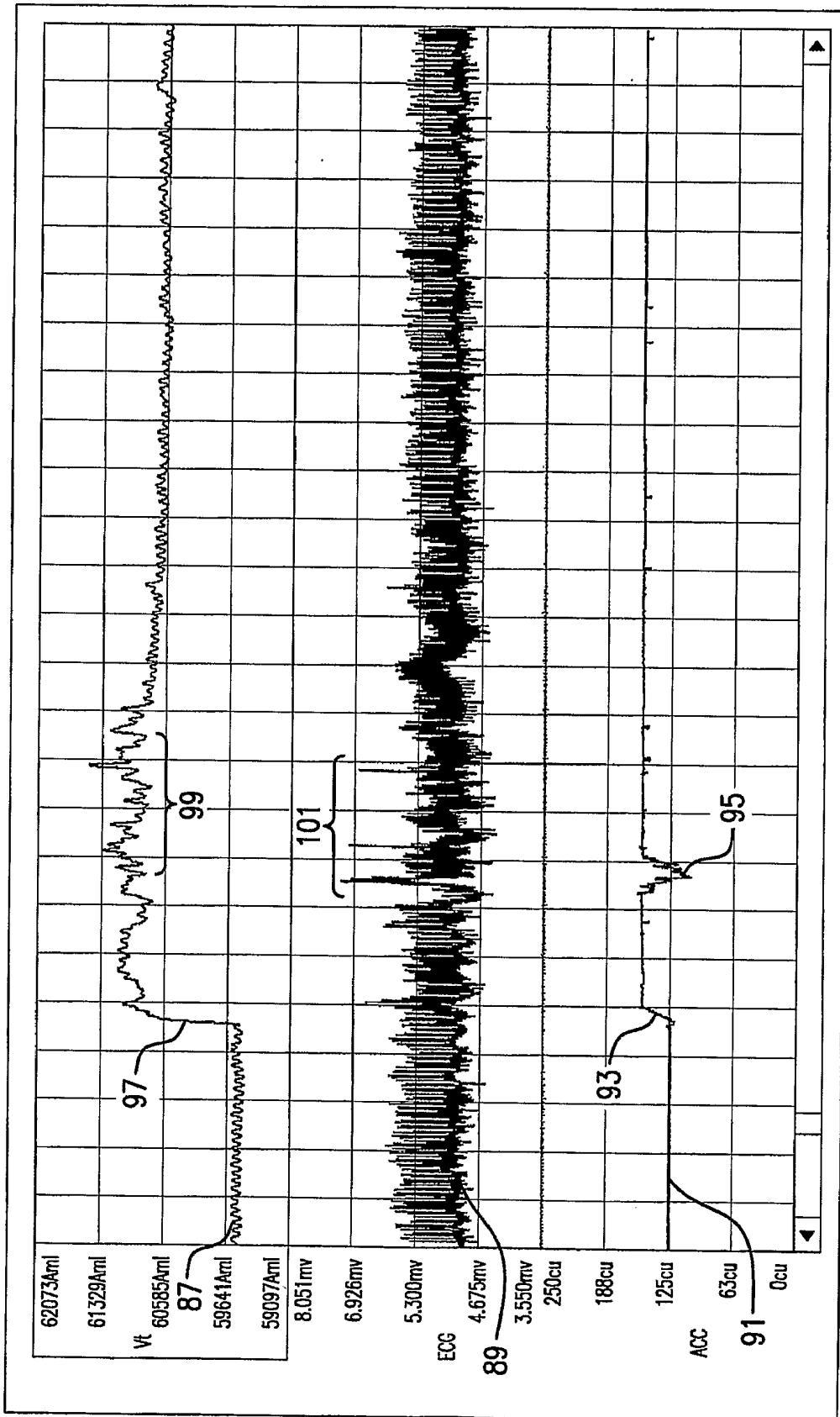

FIG.3B

8/17



FIG.3C

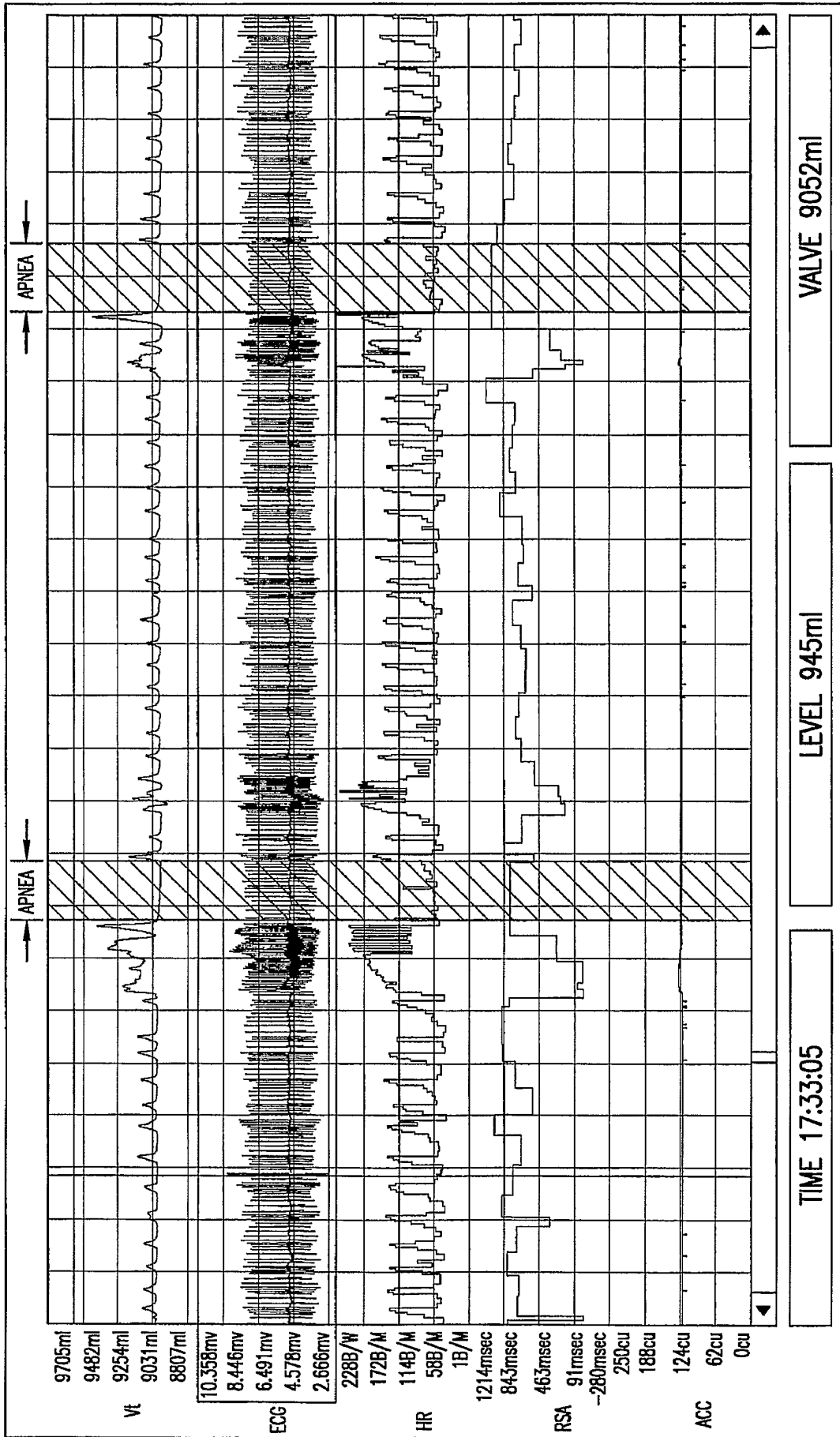

FIG. 4A

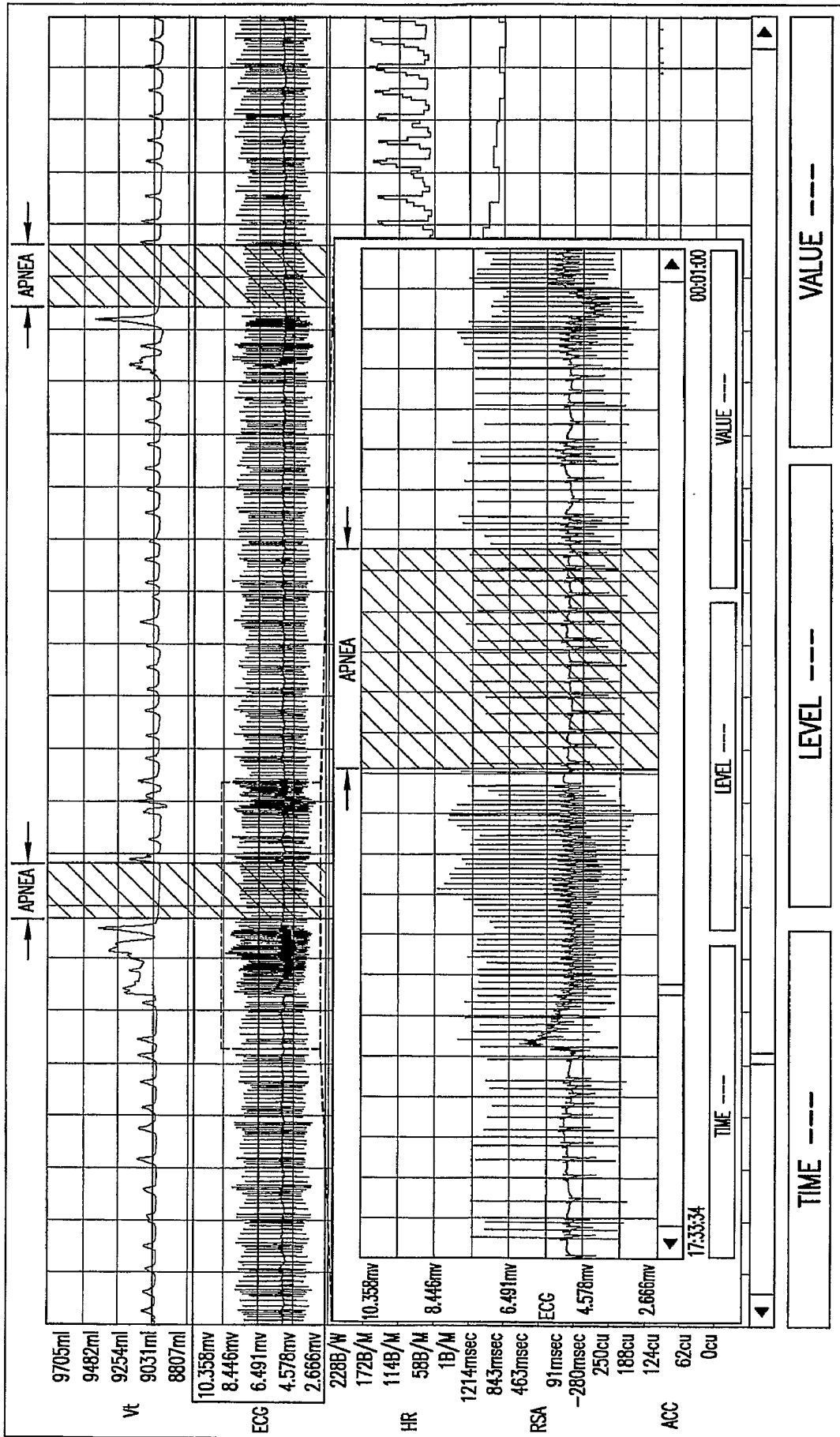

FIG.4B

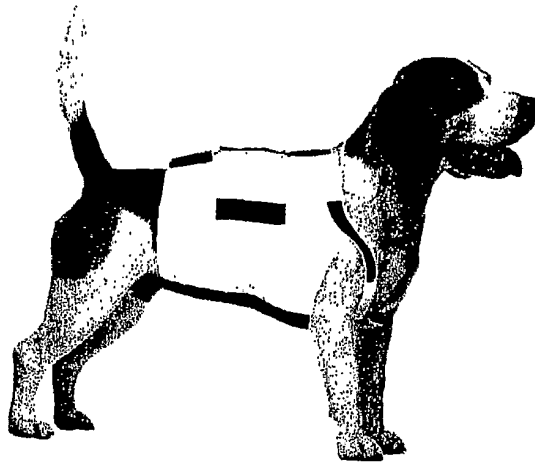

Fig. 4C

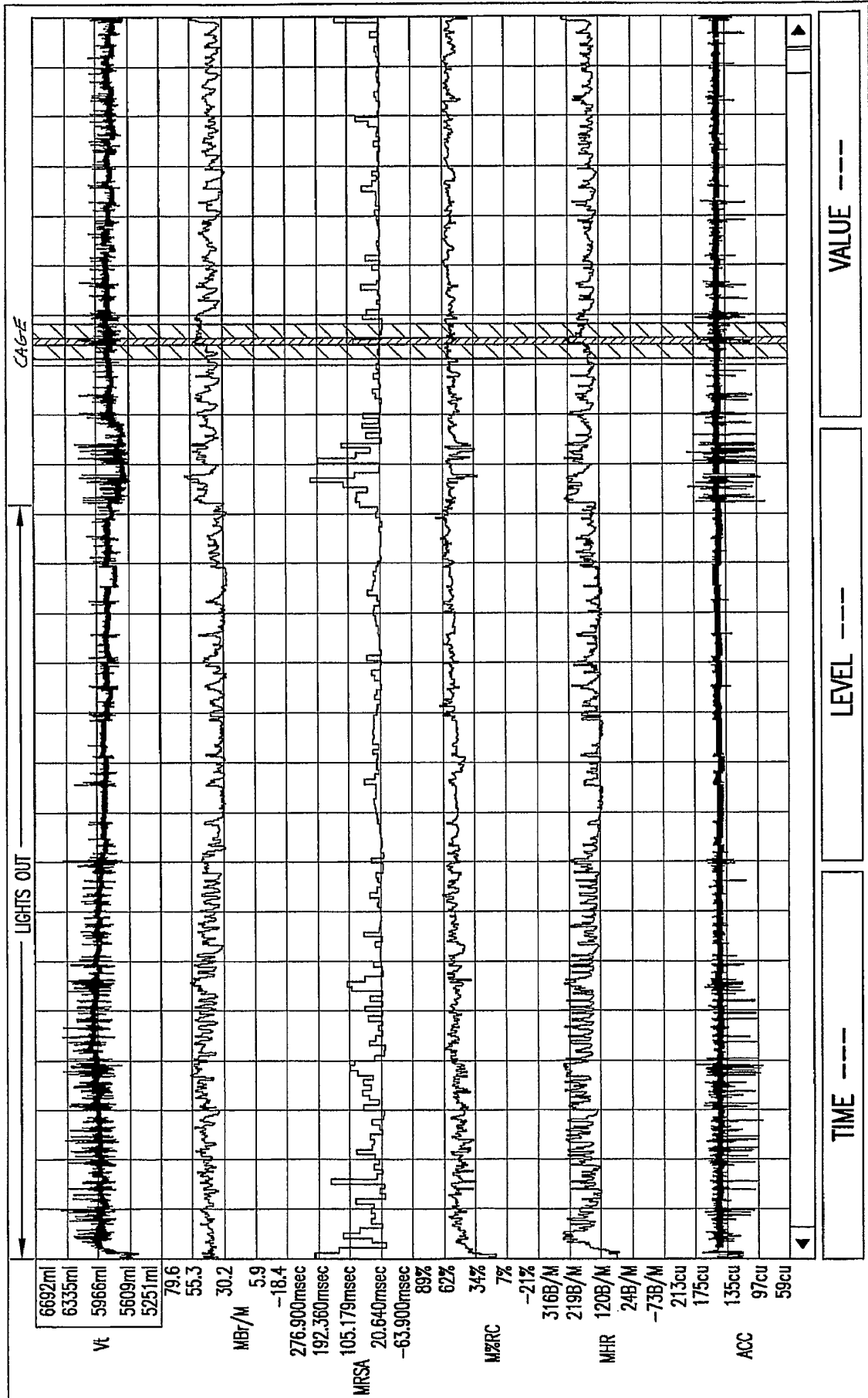

FIG.5A

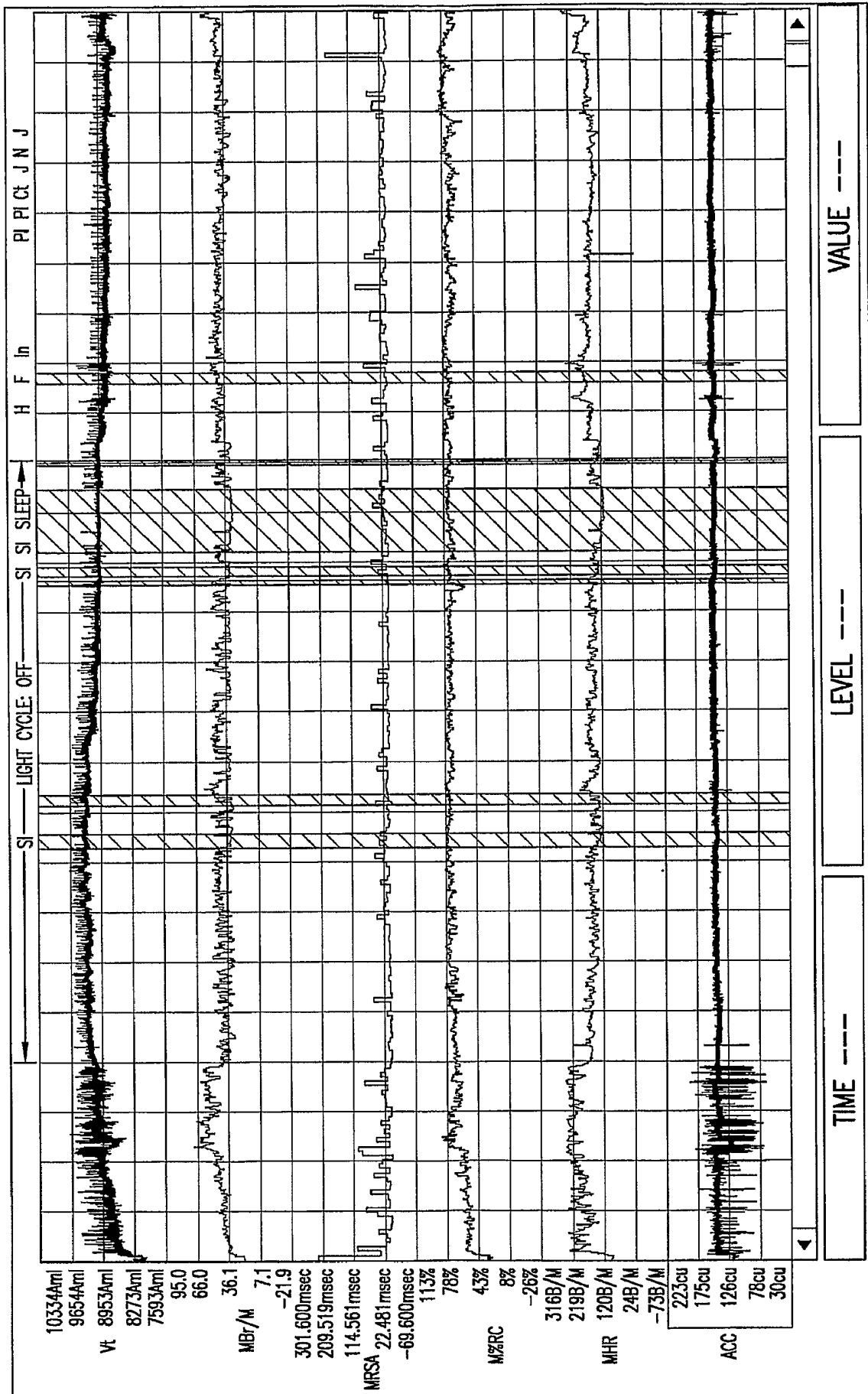

FIG.5B

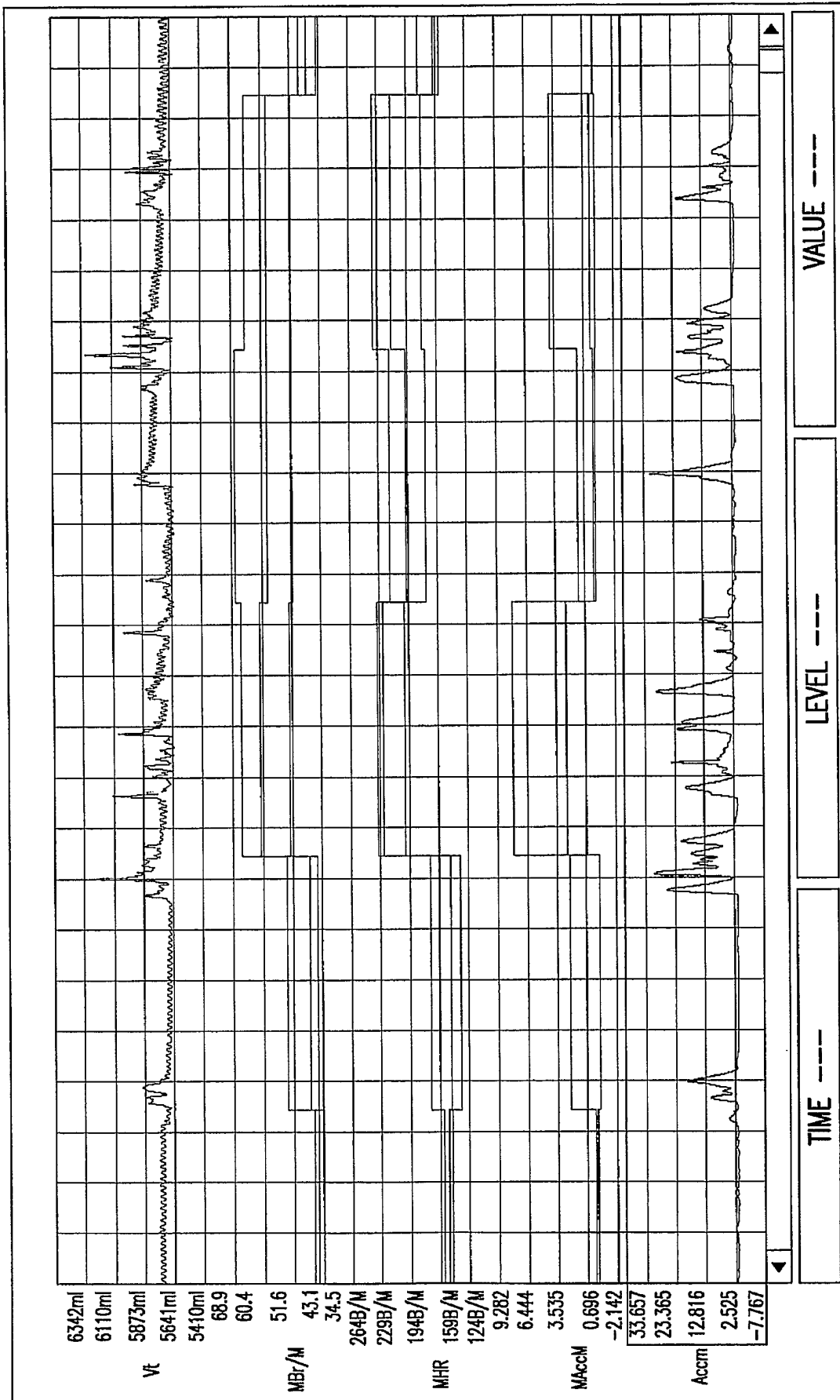

FIG. 6A

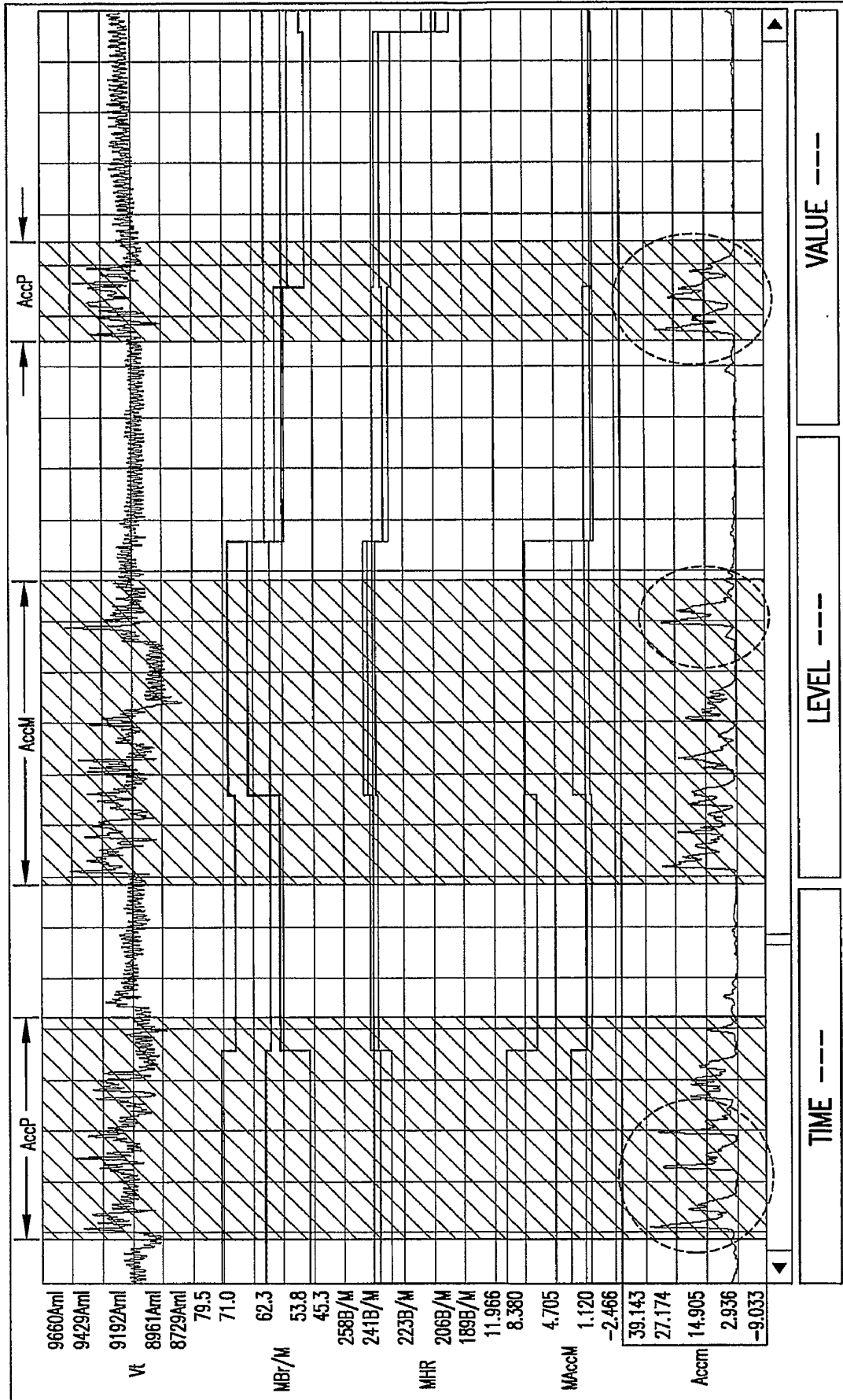

FIG. 6B

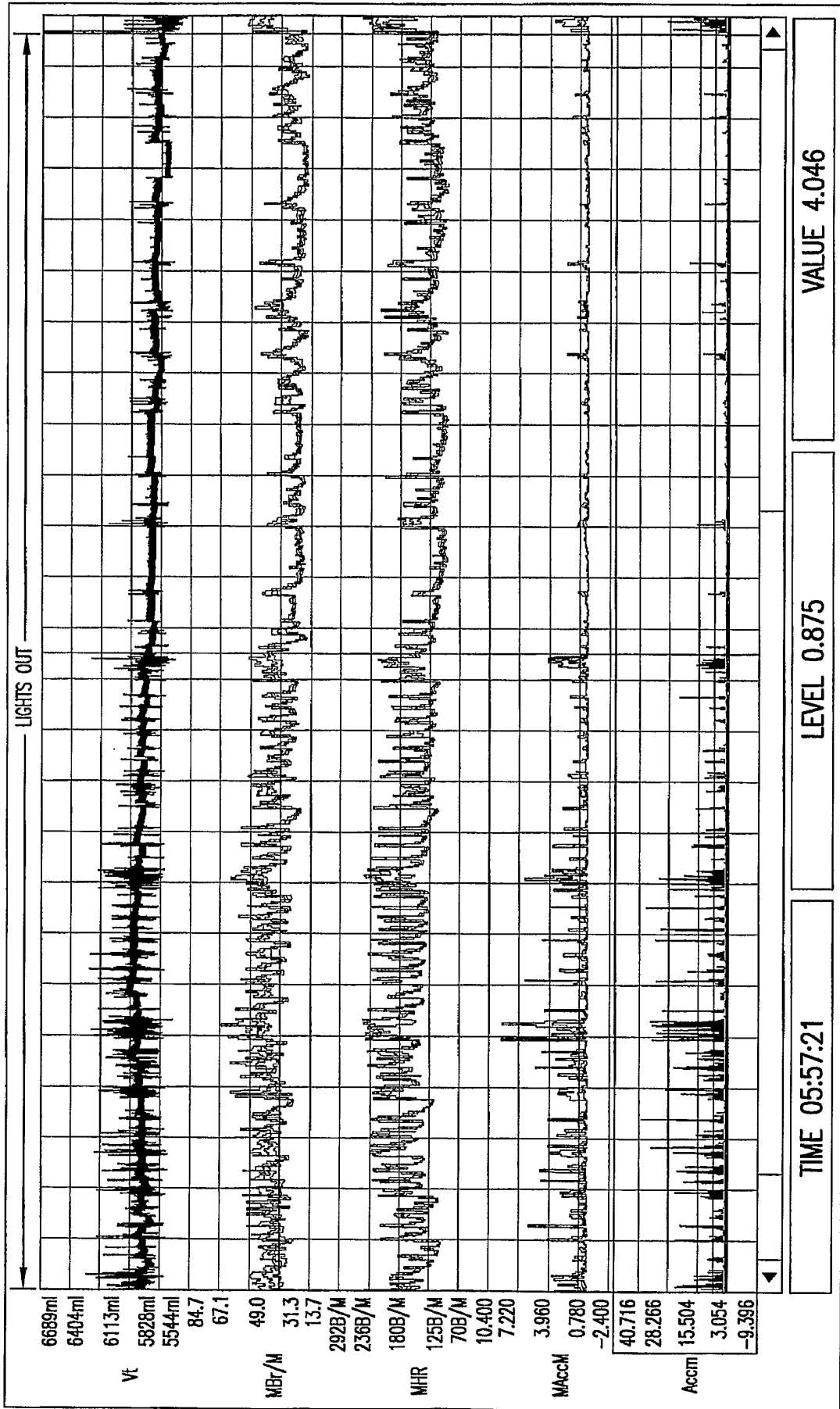

FIG. 7A

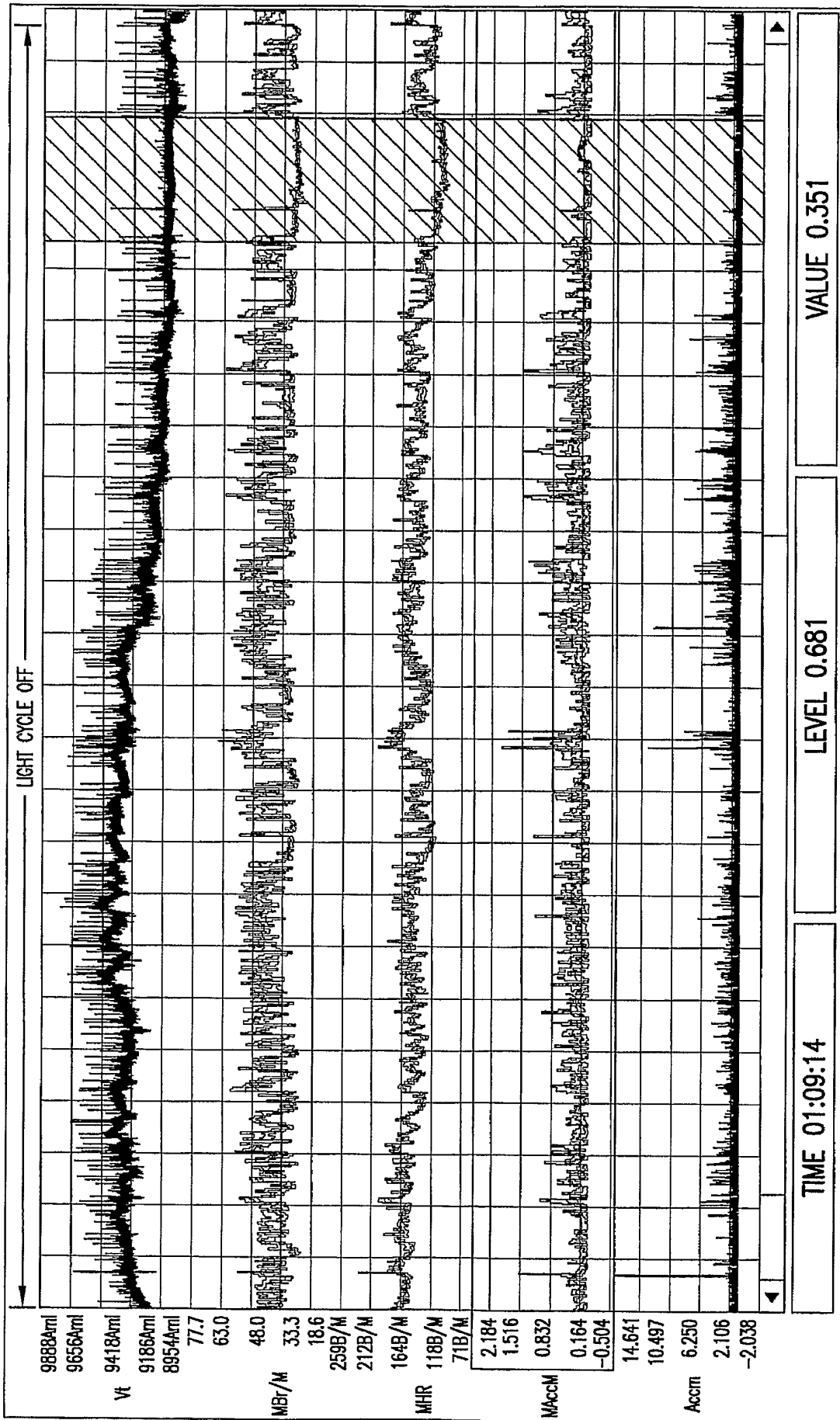

FIG.7B

专利名称(译)	用于非人类动物的非侵入性生理监测的系统和方法		
公开(公告)号	<a href="#">EP1871223A4</a>	公开(公告)日	2009-10-21
申请号	EP2006750711	申请日	2006-04-19
[标]申请(专利权)人(译)	VIVOMETRICS		
申请(专利权)人(译)	VIVOMETRICS INC.		
当前申请(专利权)人(译)	VIVOMETRICS INC.		
[标]发明人	OSTERTAG KATHRYN LYNN DERCHAK P ALEXANDER		
发明人	OSTERTAG, KATHRYN, LYNN DERCHAK, P., ALEXANDER		
IPC分类号	A61B5/00		
CPC分类号	A61B5/04325 A01K29/005 A61B5/0006 A61B5/1116 A61B5/1118 A61B5/1123 A61B5/1135 A61B5/4519 A61B5/6805 A61B2503/40 A61B2562/0219		
优先权	60/673331 2005-04-20 US		
其他公开文献	EP1871223A2		
外部链接	<a href="#">Espacenet</a>		

摘要(译)

本发明提供了用于非侵入性地监测未受约束和/或受约束的动物(例如猴子, 兔子, 狗, 马等)中的生理参数的监测服装。本发明还包括用于收集和/或处理监视数据的方法和系统。

