

(19)
(12)

(KR)
(A)

(51) 。 Int. Cl. ⁷
H05B 33/14

(11)
(43)

2002 - 0055425
2002 07 08

(21) 10 - 2001 - 0086189
(22) 2001 12 27

(30) JP - P - 2000 - 00402663 2000 12 28 (JP)

(71) 가 가

1 1 1

(72) ,가
가 가 가 - - 1 가 가
가

(74)

:

(54)

1

1

2 .

3 .

< >

1: 2:

3: 4:

5: 6:

7: 31:

32: 33:

34: 35:

36(R): 37(G):

38(B): 39:

40:

2000 12 28

2000 - 402663

(EL)

EL

EL

가 가

가 가

EL

EL

EL

EL

(輝度),

EL

가

가

1:3

가

(8 - 319482

).

가

EL

EL

EL

EL

가

가

EL

1

EL

EL

가

1

EL

(7)
(4),

EL

(1)
(5)

1

EL

(7)

(1)

(2),
(6)

(3),

2

(3)

(4),
(4)

(6)

가
2

(2)

(5)

(4)

(4)

가

2

T1

E1

가

S0,

가

E0

S1,

가

S1

T1

가

2

가 가 가

가

1000 cm⁻¹

3000 cm⁻¹

가)

가

(lowest unoccupied molecular orbital; LUMO)가

EL

가

EL

가

d

가

d

가

가

f

가

1a

1h

1a

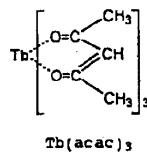

1b

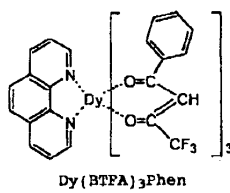

1c

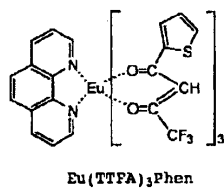

1d

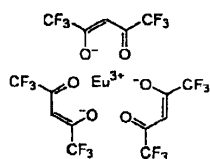

1e

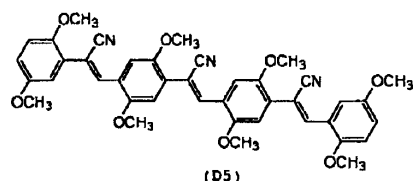

1f

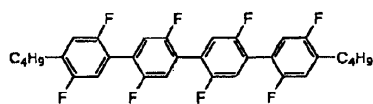

1g

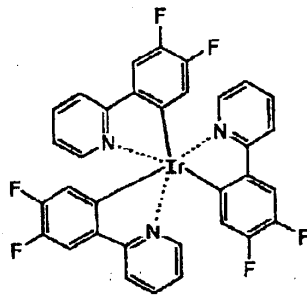

1h

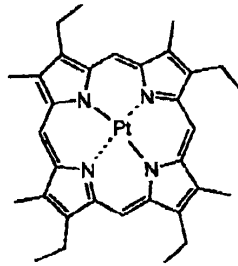

EL

가

가

2a

2k

2a

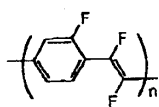

2b

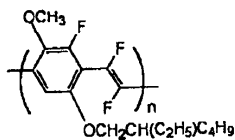

2c

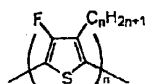

2d

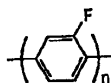

2e

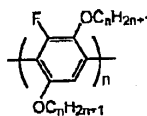

2f

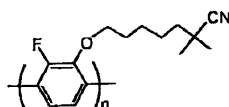

2g

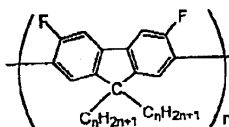

2h

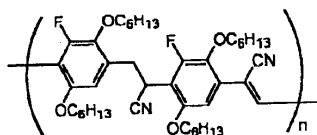

4a 4j 3a 3u ,

3a

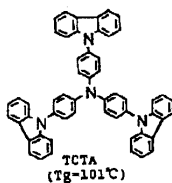

3b

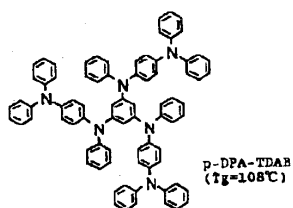

3c

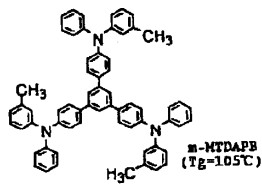

3d

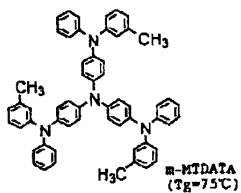

3e

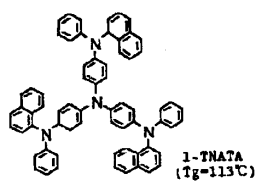

3f

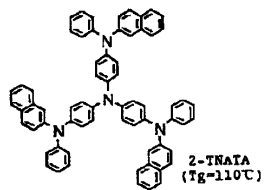

3g

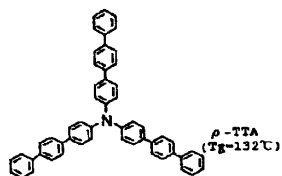

3h

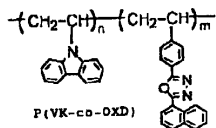

3i

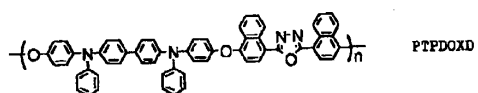

3j

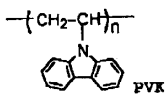

3k

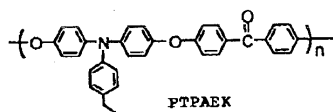

3l

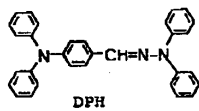

3m

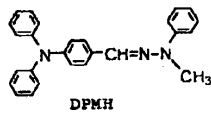

3n

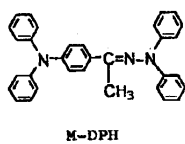

3o

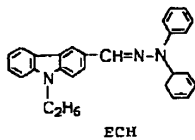

3p

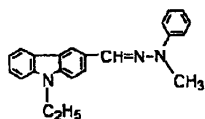

3q

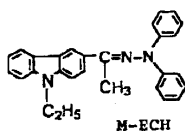

4b

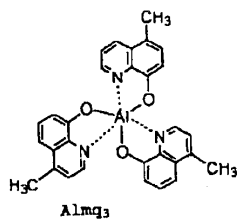

4c

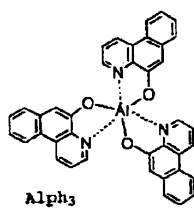

4d

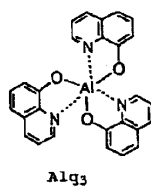

4e

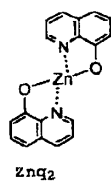

4f

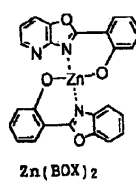

4g

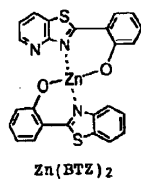

4h

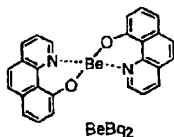

4i

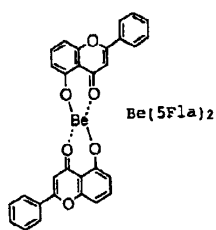

4j

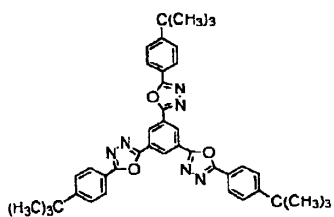

가 30 nm 200 nm 가 . 30 nm
 , 200 nm 가 .

, 1 ,

가

가

가

ITO(

EL

1

가

EL

가

3

(34)

(31)

EL 가

(34)

(31) ITO

8),

(33),

(35),

(36), (37)

(3

(36)

(R)

(39)가

3

EL 가

(34)

(37)

(G)

EL

(32)

(38)

(B)

EL

(40)

3

EL

1

가

(32)

EL

가

(36), (37)

(38)

(1)

3

2

1

3

EL

가

EL

EL

가

EL

EL

EL

EL

EL

가 .
 < 1 >
 ITO , 3u
 30 nm
 1d 0.5 % 가 2i 30 nm
 , Ba () 200 nm EL
 EL 13 V 가 EL 20 mA/cm²
 , 600 cd/m² . EL
 11,000 . 5
 0 μs .

1 ms .
 , EL ,
 가
 < 1 >
 2i , 1 2i -
 EL
 EL 15 V 가 20 mA/cm²
 , 450 cd/m² . 1 1
 가
 1 1

2i

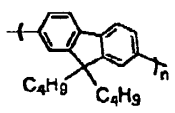

< 2 >

1d EL 1i 1i

EL 16 V 가 20 mA/cm² ,
 , 3.00 cd/m² , 2 1

1i

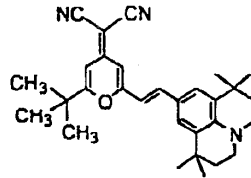

< 2 >

2j , 1 EL

EL 11,000 1 , 550 cd/m² ,

1 EL , 60 μs, 2 ms

< 3 >

1d EL 1e

EL 14 V 가 20 mA/cm² ,
 , 500 cd/m² , 12,000

1 EL , 100 μs, 1 ms

< 4 >

1d 1f 2k
 , 1 2i EL

EL 12 V 가 20 mA/cm² ,
 , 500 cd/m² , 12,000

1 EL , 20 μ s, 500 μ s .

< 5 >

1d 1h EL .

EL 12 V 가 20 mA/cm² , 700 cd/m² , 11,000 .

1 EL , 20 μ s, 100 μ s .

< 6 >

1d 1g EL .

EL 12 V 가 20 mA/cm² , 700 cd/m² , 12,000 .

1 EL , 1 μ s, 5 μ s .

< 7 >

2.5 3 , 1 100 μ m . 3 EL

(1) ITO , 50 nm (34) (33) PEDOT .
 PSS 20 nm (35) 3v

2j 3 1d 0.5 % (36)

5 % (37) 2j 1j 0.
 1f 1 % (38) 2i ,
 80 nm .

3v

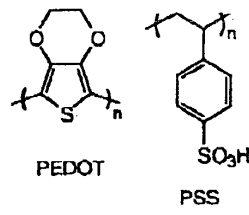

1j

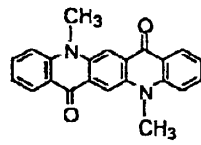

(39)
(30)

100 nm

300 nm

20 mA/cm²

15,000

EL

(57)

1.

가 가

2.

3.

1 가

4.

1 , 가

5.

1 , 가

6.

1 , 가

7.

1 , , 0.01 5 %

8.

1 ,

9.

1 ,

10.

, , , 1
- ,
가

11.

10 , 가

12.

10 , 가

13.

10 , 가

14.

10 , 가

15.

10 , , 0.01 5 %

16.

10 , .

17.

10 , .

18.

10 , - ,

가

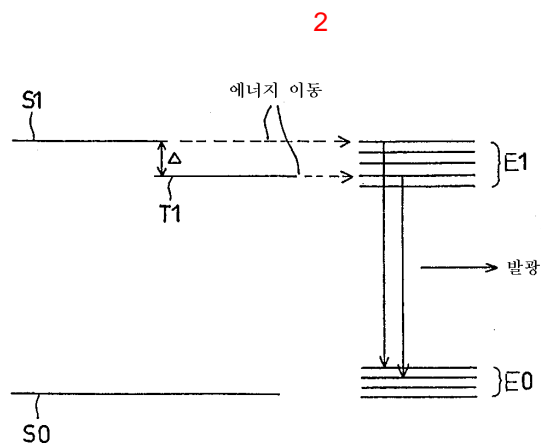
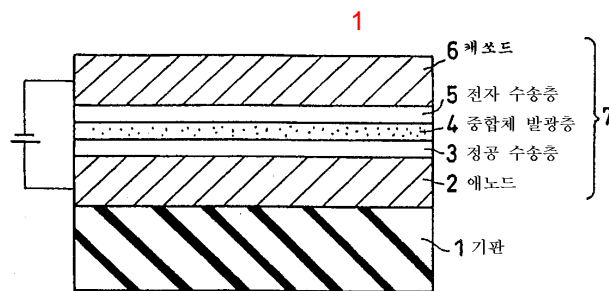

3

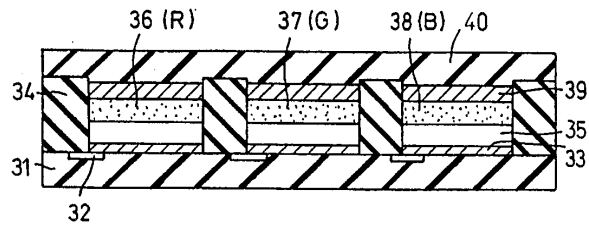

专利名称(译)	有机电致发光器件和显示器件		
公开(公告)号	KR1020020055425A	公开(公告)日	2002-07-08
申请号	KR1020010086189	申请日	2001-12-27
[标]申请(专利权)人(译)	株式会社东芝		
申请(专利权)人(译)	Sikki东芝股份有限公司		
当前申请(专利权)人(译)	Sikki东芝股份有限公司		
[标]发明人	NAITO KATSUYUKI		
发明人	NAITO,KATSUYUKI		
IPC分类号	H01L51/30 H05B33/14 H01L51/50 H01L51/00		
CPC分类号	H01L51/005 H01L51/0084 H01L51/0059 H01L51/0038 H01L51/0037 Y10S428/917 H01L51/0077 H01L51/0039 H01L51/0081 H01L51/5012 H01L51/5004 H01L51/5016		
代理人(译)	CHU, 晟敏		
优先权	2000402663 2000-12-28 JP		
其他公开文献	KR100426919B1		
外部链接	Espacenet		

摘要(译)

目的：提供有机电致发光器件和显示装置以实现高效率 and 长寿命，其利用激发单重态和激发三重态中的主体分子的能量。组成：有机电致发光器件 (7) 包括阳极 (2)，阴极 (6) 和设置在阳极和阴极之间的聚合物发光层 (4)，并包括主体分子和发光染料分子。主体分子由具有碳 - 氟键的 π 电子共轭聚合物形成，并且发光染料分子能够以激发单重态和激发三重态从主分子接收能量。

