

(19)  
(12)

(KR)  
(A)

(51) Int. Cl.<sup>7</sup>  
C09K 11/06

(11)  
(43)

10-2004-0069436  
2004 08 06

(21) 10-2003-0005827  
(22) 2003 01 29

(71) 557-6

(72) APT112-302

(74)  
:

(54)

가 , 1 2 가 , 1

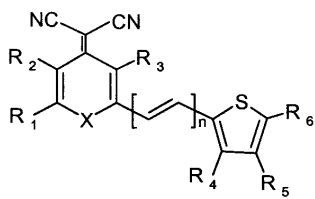

, X C, O, S, SO<sub>2</sub>, N, R<sub>1</sub>, R<sub>3</sub>, 1, 5, 4, 6, R<sub>4</sub>, R<sub>5</sub>, (ring), R<sub>1</sub>, R<sub>6</sub>, R<sub>1</sub>, O, n, 1, 2, 3

1

2

EL(Electroluminescence device) (Liquid Crystal Display  
; LCD), (Plasma Display Panel; PDP), (Field Emission Display; F  
ED) 가 , EL 가  
가 , 가 , 가  
가 ITO 가 Mg 가  
(full color)  
(R), (G) (B)  
3,852,683 , 3,986,140 , 4,012,376 , 4,146,7  
07 , 4,769,292 , 5,018,160 , 5,294,869 , 5,409,783 , 5,492,942 , 5,908,581 , 5,935,72  
0 , C. H. Chen C. W. Tang 'Design and Synthesis of Red Dopants for Electroluminescence' (Chemistry  
of Functional Dyes, Vol.2, pp.536-543 (1993)), C. W. Tang, S. A. VanSlyke, C. H. Chen, 'Electroluminesce  
nce of Doped Organic Thin Films'(Journal of Applied Physics, Vol.65, pp.3610-3616 (1989)), Junsheng YU, Z  
hijian CHEN, Seizo MIYATA, 'Red-light-emitting organic electroluminescent devices with bisanil dye as emi  
tter' (Jpn. J. Appl. phys. Vol. 40(2001) pp. 3201-3205)  
, 590nm 4-( )-2- -6-(p-  
)-4H- (4-(dicyanomethylene)-2-methyl-6-(p-dimethylaminostyryl)-4H-pyran: DCM) 630nm  
DCM 4- -6-cp- -2-t- -4H- (4-dicyanome  
thylene-6-cp-julolidinostyryl -2-tert-butyl- 4H-pyran: DCJTB) , DCM

1, 2 ; 가

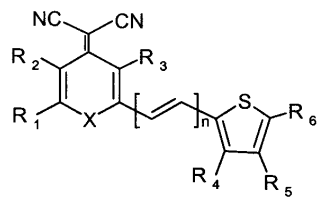

X C, O, S, SO<sub>2</sub>, N, R<sub>1</sub>, R<sub>3</sub>, R<sub>4</sub>, R<sub>5</sub>, R<sub>6</sub>, O, (ring), n 1, 2, 3

1 가

1

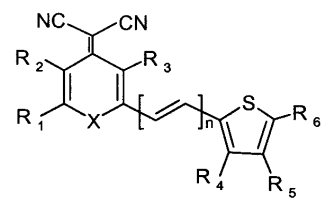

X C, O, S, SO<sub>2</sub>, N, R<sub>1</sub>, R<sub>3</sub>, R<sub>4</sub>, R<sub>5</sub>, R<sub>6</sub>, O, (aryl), (heteroaryl), (fused ring), (ring), n 1, 2, 3

R<sub>1</sub>, R<sub>6</sub>, X가 C, N, R<sub>1</sub>

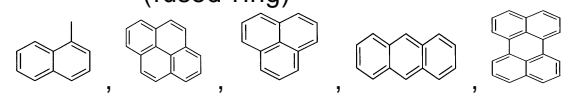

2, 2, 4 가

2

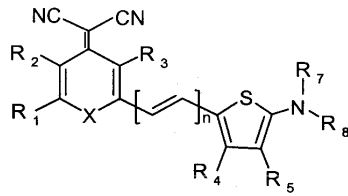

1 R<sub>1</sub>, X, R<sub>1</sub> R<sub>5</sub> 가 1, R<sub>7</sub> R<sub>8</sub>

3

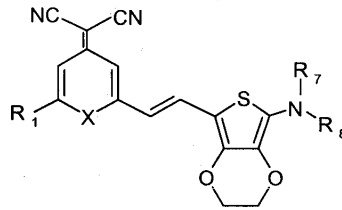

tert- , X, R<sub>1</sub>, R<sub>7</sub> R<sub>8</sub> 2 , X O , R<sub>1</sub>  
 , R<sub>7</sub> R<sub>8</sub>

4

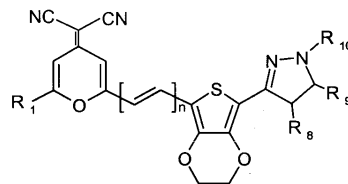

, R<sub>1</sub>, R<sub>8</sub> R<sub>10</sub> 1 R<sub>1</sub> 가 , n 1, 2 3 ,  
 R<sub>1</sub> tert- , R<sub>8</sub> , R<sub>9</sub> , R<sub>10</sub> 3-  
 (donor) (thiophene), 3,4- (3,4)  
 (pyrazoline)

ylidene)-malononitrile) 2-(6- - -4- )- (2-(6-methyl-pyran-4-

1 (10) 1 (12, ) , 1  
 1 (12) (14)  
 (host) / (dopant) Alq3 (fluorescent dye),  
 2 50 % (14)  
 가 2 (16) 1 (12) , 1 2 (12, 16) 가

(14) , (14) ,  
 1 (12) (10) .  
 (10) , 1 (12)  
 (12) , 가 (Indium Tin Oxide; ITO), , (Ag)  
 2 (16) 가 Al, Mg, Ca LiAl, Mg-Ag  
 2  
 1 2 (12, 16) 가 (14) , 2 (12,  
 16) (14) (21, 22) (25, 26)  
 1 (21, 22) (12)  
 (21, 22) 4,356,429 (phthalocyanine)  
 (CuPc) (porphyrinic) , N,N'- -N,N'- (3- )-[1,1'- ]- 4,4'-  
 (N,N'- diphenyl-N,N'bis(3-methylphenyl)-[1,1'-biphenyl]-4,4'-diamine: TPD) (tri(phenyl  
 diamine)) , 4,4',4'- [3- ( ) ] (4,4',4'-tris[3-methylphenyl(phenyl)a  
 mino]triphenylamine: m-MTDATA), N,N'- -N,N'- (1- )-1,1'- -4,4'- (N,N'-di  
 phenyl- N,N'-bis(1-naphthylphenyl)-1,1'-biphenyl-4,4'-diamine: -NPD), N,N,N'N'- (m-  
 )-1,3- (N,N,N'N'-tetrakis(m-methylphenyl)-1,3-diaminobenzene: PDA), 1,1- [N,N- (p-  
 ) ] (cyclohexa 1,1-bis[N,N-di(p-tolyl)aminophenyl]cyclohexane: TPAC),  
 , N,N'- -(1- )-N,N'- 가  
 (25, 26) (16)  
 AZ), (quinolin) , (8- ) , LiF, 1,2,4- (1,2,4-triazole: T  
 (14), (14) (tris(8-quinolinolate)aluminum, Alq3)  
 (21, 22) (25, 26)  
 5 1000nm, 10 500nm 가  
 (21, 22) / (25, 26)  
 (spin coating) , (thermal evaporation) , (spin casting)  
 (sputtering) , (e-beam evaporation) , (Chemical vapor deposition: CVD)  
 가  
 (e-gun) (thermal) (sputtering) , (ion plating)  
 (thermal evaporation) , (ion plating)  
 1 2

[ 1] 2-{2-tert- -6-[2-(7- -2,3- - [3,4- b][1,4] -5- )- ]-  
 -4- }-

1 , 2-(2-tert- -6- -4- )- (2-(2-tert-Butyl-6-  
 methyl-pyran-4-ylidene)-malononitrile) 2.14g(10 mmol) 7- -2,3- - [3,4-b][1,4  
 ] -5- (7-Dimethylamino-2,3-dihydro-thieno[3,4-b][1,4]dioxine-5-carbaldehyde) 2.13g(1  
 0 mmol) 100ml , 0.93g(11 mmol) 가 75 10 가  
 , , 2g( 48%) .

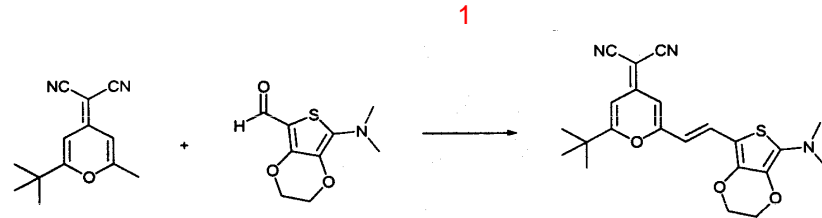

[ 2] 2-(2-tert-butyl-6-cyano-4-methylphenyl)-2,3-dihydrothieno[3,4-b][1,4]dioxine-5-carbaldehyde 0.4g(1 mmol) 30ml, 2-(2-tert-butyl-6-cyano-4-methylphenyl)-2,3-dihydrothieno[3,4-b][1,4]dioxine-5-carbaldehyde 0.21g(1 mmol) 7-(5-phenyl-1-m-tolyl-4,5-dihydro-1H-pyrazol-3-yl)-2,3-dihydrothieno[3,4-b][1,4]dioxine-5-carbaldehyde 93 mg(1.1 mmol) 가 , 75 10 가 . 0.42g( 70%)

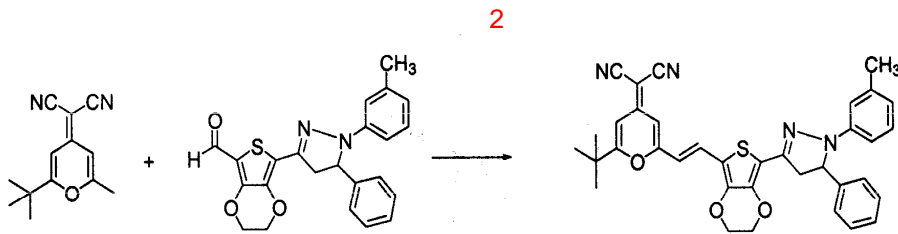

[ 3] 2-(2-tert-butyl-6-cyano-4-methylphenyl)-2,3-dihydrothieno[3,4-b][1,4]dioxine-5-carbaldehyde 1g(2.81 mmol) 50ml, 2-(2-tert-butyl-6-cyano-4-methylphenyl)-2,3-dihydrothieno[3,4-b][1,4]dioxine-5-carbaldehyde 0.28g(3.37 mmol) 가 , 24 가 . 0.79g( 50%)

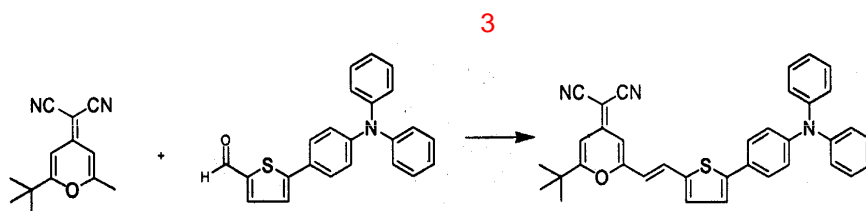

[ 4] (ITO)가 ITO -NPD 200 m-MTDATA 300 (host) 650 Alq3 (dopant) 1 3 ( 50 : 2 50 %), 650 LiF 50 TAZ 5 Al 2000

1, 3, 4, (T<sub>m</sub>), (Dichloroethane), PL(photoluminescence), 1

[ 1 ]

	PL(nm)	Tm( )	(cd/m <sup>2</sup> )	
1	625	280	4952 / 14 V	2 %
2	680	312	1873 / 19.4 V	2 %
3	660	257	2650 / 16.5 V	2 %

1, (T<sub>m</sub>), 가

(Photodiode), (Photovoltaic cell, Solar Cell), (Full Color), (Field Effect Transistor), (Organic Laser), (Laser Diode)

(57)

1.

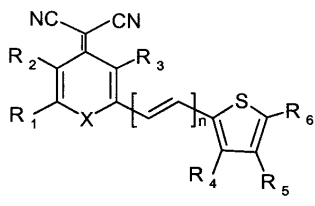

(, X, C, O, S, SO<sub>2</sub>, N, R<sub>1</sub>, R<sub>3</sub>, 1, 5, 4, 6, R<sub>1</sub>, R<sub>4</sub>, R<sub>5</sub>, (ring), R<sub>6</sub>, R<sub>1</sub>, O, n, 1, 2, 3, .)

2.

1, 2

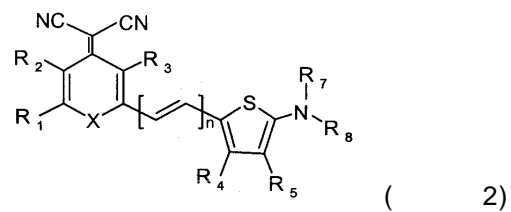

(  $R_1, R_2, R_3, R_4, R_5, R_7, R_8$  가 , X, R<sub>1</sub> R<sub>5</sub> , R<sub>7</sub> R<sub>8</sub> )

3.

1 , 3 .

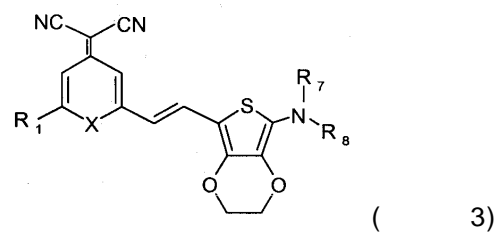

(  $R_1, R_7, R_8$  , X, R<sub>1</sub>, R<sub>7</sub> R<sub>8</sub> 2 . )

4.

3 , X O , R<sub>1</sub> tert- , R<sub>7</sub> R<sub>8</sub> .

5.

1 , 4 .

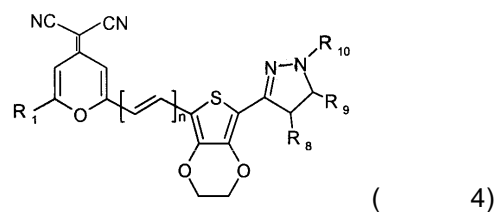

(  $R_1, R_8, R_{10}$  , R<sub>1</sub>, R<sub>8</sub> R<sub>10</sub> 1 R<sub>1</sub> 가 , n 1, 2 3 . )

6.

5 , R<sub>1</sub> tert- , R<sub>8</sub> , R<sub>9</sub> , R<sub>10</sub> 3-

7.

1 ;

2 ;

1 가 , 1 2

8.

7 , 1 가

1

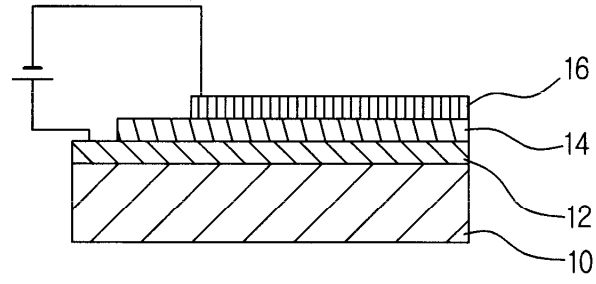

2

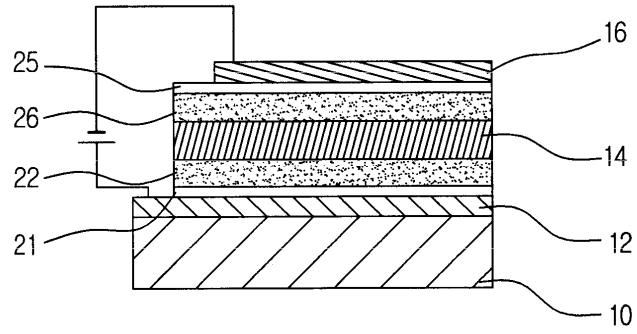

专利名称(译)	红色有机发光化合物和含有它们的有机发光器件		
公开(公告)号	<a href="#">KR1020040069436A</a>	公开(公告)日	2004-08-06
申请号	KR1020030005827	申请日	2003-01-29
[标]申请(专利权)人(译)	娜我比可隆株式会社		
申请(专利权)人(译)	Neoview的隆有限公司		
当前申请(专利权)人(译)	Neoview的隆有限公司		
[标]发明人	HWANG HAGEUN		
发明人	HWANG,HAGEUN		
IPC分类号	C09K11/06		
CPC分类号	C09K11/06 C09K2211/1088 C09K2211/1092 H01L51/0065 H01L51/0068 H01L51/5012 H05B33/14 Y10S428/917		
代理人(译)	李相HUN		
其他公开文献	KR100487011B1		
外部链接	<a href="#">Espacenet</a>		

摘要(译)

本发明公开了一种红色有机电致发光化合物，其中耐热性高并且容易控制发光的色相，并且包括该红色有机电致发光化合物的有机发光装置。有机发光化合物具有以下化学式的结构。并且有机发光装置包括第二电极和具有第一电极的红色有机电致发光化合物，并且低功函数具有高功函数。并且包括位于第一和第二电极之间的至少一个有机化合物层。在上式中，X为C，R<sub>1</sub>至R<sub>3</sub>为O，S，SO<sub>2</sub>或N为n为1，且2或3为胺基的取代或未取代基。相同或它可以是不同的，它是氢，取代或未取代的碳原子数1至20的烷基，取代或未取代的碳原子数1至5的烷氧基，芳基或杂芳基取代或未取代的碳原子数4至24，取代或未取代的碳原子数4至6或碳原子数4至24和R<sub>4</sub>和R<sub>5</sub>的杂环基团的稠环基团是R<sub>1</sub>和R<sub>5</sub>中的R<sub>4</sub>和R<sub>5</sub>可以连接，R<sub>4</sub>和R<sub>5</sub>连接，可以形成杂环，R<sub>6</sub>与R<sub>1</sub>中的R<sub>6</sub>相同。红色荧光化合物，有机发光器件，耐热性，稳定性。

