



(11) **EP 2 009 715 A2**

(12) **EUROPEAN PATENT APPLICATION**

(43) Date of publication:  
**31.12.2008 Bulletin 2009/01**

(51) Int Cl.:  
**H01L 51/52 (2006.01)**

(21) Application number: **08252229.3**

(22) Date of filing: **27.06.2008**

(84) Designated Contracting States:  
**AT BE BG CH CY CZ DE DK EE ES FI FR GB GR  
HR HU IE IS IT LI LT LU LV MC MT NL NO PL PT  
RO SE SI SK TR**  
Designated Extension States:  
**AL BA MK RS**

(30) Priority: **28.06.2007 KR 20070064293**

(71) Applicant: **Samsung SDI Co., Ltd.  
Suwon-si, Gyeonggi-do (KR)**

(72) Inventors:  
• **Oh, Min-Ho**  
**Suwon-si**  
**Gyeonggi-do (KR)**  
• **Cho, Yoon-Hyeung**  
**Suwon-si**  
**Gyeonggi-do (KR)**  
• **Lee, Byoung-Duk**  
**Suwon-si**  
**Gyeonggi-do (KR)**  
• **Lee, So-Young**  
**Suwon-si**  
**Gyeonggi-do (KR)**

- **Lee, Sun-Young**  
**Suwon-si**  
**Gyeonggi-do (KR)**
- **Kim, Won-Jong**  
**Suwon-si**  
**Gyeonggi-do (KR)**
- **Choi, Jin-Baek**  
**Suwon-si**  
**Gyeonggi-do (KR)**
- **Lee, Jong-Hyuk**  
**Suwon-si**  
**Gyeonggi-do (KR)**
- **Lee, Seung-Han**  
**Suwon-si**  
**Gyeonggi-do (KR)**
- **Kim, Yong-Tak**  
**Suwon-si, Gyeonggi-do (KR)**

(74) Representative: **Mounteney, Simon James**  
**Marks & Clerk**  
**90 Long Acre**  
**London**  
**WC2E 9RA (GB)**

(54) **Light emitting display and method of manufacturing the same**

(57) A light emitting display and a method of manufacturing the same, wherein the light emitting display includes a first substrate on which a plurality of light emitting devices is formed, a second substrate provided to face the first substrate, a dam member provided between the first substrate and the second substrate to surround the plurality of light emitting devices, an inorganic sealing material provided between the first substrate and the second substrate on an outer circumference of the dam

member to attach the first substrate and the second substrate to each other, and a filling material provided on an internal side of the dam member to cover the plurality of light emitting devices. The inorganic sealing material effectively shields moisture or oxygen and/or increases the life of the light emitting display. The filling material fills the space between the substrates to improve mechanical reliability.

FIG. 2

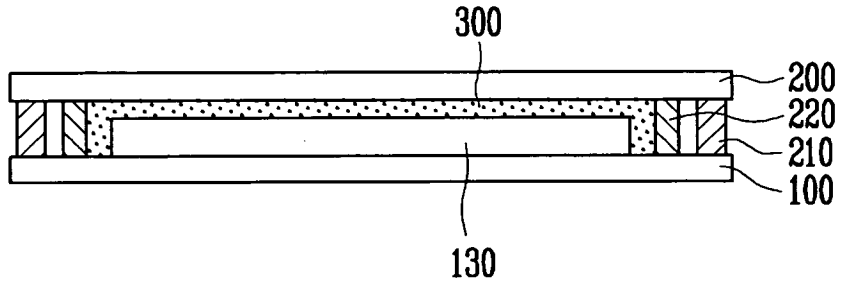

**Description****BACKGROUND**Technical Field

**[0001]** This disclosure relates to a light emitting display and a method of manufacturing the same, and more particularly to, a light emitting display seal comprising an inorganic sealing material and a method of manufacturing the same.

Discussion of Related Art

**[0002]** Since a light emitting device such as an organic light emitting diode (OLED) includes organic materials vulnerable to moisture and/or oxygen, it is desirable to protect the OLED against moisture and/or oxygen.

**[0003]** Since a light emitting display using an OLED typically has a wide viewing angle, high contrast and response speed, and low power consumption, in spite of its vulnerability to moisture and/or oxygen, light emitting displays are widely used in personal portable apparatus, such as MP3 players, mobile telephones, and televisions (TV). The thicknesses of light emitting displays have been gradually reduced in accordance with the requests of users.

**[0004]** However, when the thickness of a substrate of a light emitting display is reduced to no more than about 0.3 mm in order to reduce the thickness thereof, it is difficult to maintain the mechanical integrity of the device under stresses such as falling and twisting. Loss of mechanical integrity can compromise the sealed state of the device, thereby reducing the life of the organic light emitting display.

**SUMMARY OF THE INVENTION**

**[0005]** Accordingly, it is an object to provide a light emitting display capable of securing mechanical reliability and of increasing a life and a method of manufacturing the same.

**[0006]** It is another object to provide a light emitting display capable of securing mechanical reliability while using an inorganic sealing material that effectively prevents moisture or oxygen from penetrating and a method of manufacturing the same.

**[0007]** Some embodiments provide a light emitting display comprising an improved sealing system and a method of manufacturing the same, the light emitting display comprising a first substrate on which a plurality of light emitting devices is disposed; a second substrate facing the plurality of light emitting devices; an inorganic seal disposed between the first substrate and the second substrate, and around a circumference of the second substrate; a dam member disposed between the first substrate and the second substrate and inward of the inorganic seal; and a filling material disposed filling the space

defined by the first substrate, the second substrate, and the dam member. Embodiments of the display exhibit one or more of improved resistance to moisture and/or oxygen infiltration, and improved mechanical reliability of the seal. Some embodiments also exhibit reduced Newton's ring.

**[0008]** In order to achieve the foregoing and/or other objects, according to one aspect, there is provided a light emitting display including a first substrate on which a plurality of light emitting devices is formed, a second substrate provided to face the first substrate, a dam member provided between the first substrate and the second substrate to surround the plurality of light emitting devices, an inorganic sealing material provided between the first substrate and the second substrate on an outer circumference of the dam member to attach the first substrate and the second substrate to each other, and a filling material provided on an internal side of the dam member to cover the plurality of light emitting devices.

**[0009]** According to another aspect, there is provided a method of manufacturing a light emitting display including providing a first substrate on which a plurality of light emitting devices is formed, providing a second substrate, forming an inorganic sealing material on an outer circumference of the second substrate, forming a dam member on the second substrate on an internal side of the inorganic sealing material to surround the plurality of light emitting devices, dropping a liquid filling material to an inside of the dam member, providing the first substrate and the second substrate to face each other, and attaching the inorganic sealing material to the first substrate and the second substrate to seal up the plurality of light emitting devices.

**[0010]** Some embodiments provide a light emitting display comprising: a first substrate comprising a plurality of light emitting devices disposed thereon; a second substrate facing the plurality of light emitting devices disposed on the first substrate; a dam member disposed between the first substrate and the second substrate, surrounding the plurality of light emitting devices; an inorganic sealing material securing the first substrate and the second substrate to each other, disposed between the first substrate and the second substrate and around an outer circumference of the dam member to attach the first substrate and the second substrate; and a filling material inward of the dam member and between the first substrate and the second substrate, covering the plurality of light emitting devices.

**[0011]** In some embodiments, the dam member comprises an inorganic material. In some embodiments, the inorganic material comprises frit. In some embodiments, a reflecting layer that reflects laser and/or infrared (IR) radiation is disposed on a surface of the dam member. In some embodiments, the reflecting layer comprises at least one of Au, Ag, Pt, and Al. In some embodiments, at least a portion of the dam member contacts the inorganic sealing material. In some embodiments, dam member does not contact the inorganic sealing material.

**[0012]** In some embodiments, the dam member comprises an organic material. In some embodiments, the organic material comprises at least one of epoxy, epoxy acrylate, urethane, urethane acrylate, urethane acrylic, allyl resin, silicone, bisphenol A type epoxy silicone, cycloaliphatic epoxy silicone resin, acrylic epoxy silicone resin, allyl ether silicone, allyl methacrylate silicone, phenyl silicone resin, aliphatic urethane acrylate, and rubber.

**[0013]** In some embodiments, the dam member and the inorganic sealing material are separated from each other by at least about 50  $\mu\text{m}$ .

**[0014]** In some embodiments, the inorganic sealing material comprises frit. In some embodiments, the frit is meltable by laser and/or IR radiation. In some embodiments, the frit comprises a transition metal compound.

**[0015]** In some embodiments, the filling material fills at least some of a space between the plurality of light emitting devices and the second substrate inward of the dam member. In some embodiments, at least a portion of the filling material contacts the dam member. In some embodiments, at least a portion of the filling material contacts the second substrate. In some embodiments, the filling material comprises a solid material. In some embodiments, the filling material comprises a heat, electron beam, and/or UV radiation hardening material. In some embodiments, the filling material comprises at least one of epoxy, epoxy acrylate, urethane, urethane acrylate, urethane acrylic, allyl resin, silicone, bisphenol A type epoxy silicone, cycloaliphatic epoxy silicone resin, acrylic epoxy silicone resin, allyl ether silicone, allyl methacrylate silicone, phenyl silicone resin, aliphatic urethane acrylate, and rubber.

**[0016]** In some embodiments, the filling material comprises a liquid material. In some embodiments, the filling material comprises silicone and/or silicone oil. In some embodiments, the filling material comprises at least one of hexamethyldisiloxane, octamethyltrisiloxane, decamethyltetrasiloxane, dodecamethylpentasiloxane, and polydimethylsiloxanes.

**[0017]** Some embodiments provide a method of manufacturing a light emitting display comprising: providing a first substrate comprising a plurality of light emitting devices are formed; providing a second substrate facing the plurality of light emitting devices disposed on the first substrate; disposing an inorganic sealing material on an outer circumference of the second substrate; disposing a dam member on the second substrate inward of the inorganic sealing material and surrounding the plurality of light emitting devices; disposing a liquid filling material inward of the dam member; and securing the inorganic sealing material to the first substrate and the second substrate, thereby sealing up the plurality of light emitting devices.

**[0018]** In some embodiments, disposing the inorganic sealing material comprises: applying frit paste; and drying and/or annealing the frit paste.

**[0019]** In some embodiments, disposing the dam member comprises: applying frit paste; and drying and/or

annealing the frit paste, thereby hardening the frit paste. In some embodiments, at least a portion of the dam member contacts the inorganic sealing material. In some embodiments, disposing the dam member comprises: applying a liquid organic material, wherein the liquid organic material does not contact the inorganic sealing material; and hardening the liquid organic material.

**[0020]** In some embodiments, securing the inorganic sealing material to the first substrate and the second substrate to face each other is performed at a pressure lower than atmospheric pressure. In some embodiments, the pressure is from about 1 Pa to about 10,000 Pa.

**[0021]** Some embodiments further comprise compressing the first substrate and the second substrate, thereby filling with the liquid filling material spaces between the light emitting devices and the second substrate within the dam member. Some embodiments further comprise hardening the liquid filling material.

**[0022]** In some embodiments, securing the inorganic sealing material to the first substrate and the second substrate comprises melting the inorganic sealing material. In some embodiments, the inorganic sealing material is melted by laser and/or IR radiation.

**[0023]** According to an aspect of the invention, there is provided a light emitting display as set out in Claim 1. Preferred features of this aspect are set out in claims 2 to 33.

## BRIEF DESCRIPTION OF THE DRAWINGS

**[0024]** These and/or other embodiments and features will become apparent and more readily appreciated from the following description of certain embodiments, taken in conjunction with the accompanying drawings of which:

**[0025]** FIG. 1 is a perspective view illustrating an embodiment of a light emitting display;

**[0026]** FIG. 2 is a cross-sectional view taken along section line I1-I2 of FIG. 1;

**[0027]** FIGs. 3A and 3B are plan views illustrating an embodiment of a method of manufacturing the light emitting display; and

**[0028]** FIGs. 4A to 4F are cross-sectional views illustrating the embodiment of the method of manufacturing the light emitting display.

## DETAILED DESCRIPTION OF EMBODIMENTS

**[0029]** Hereinafter, certain embodiments will be described with reference to the accompanying drawings. Here, when a first element is described as being coupled to a second element, the first element may be not only directly coupled to the second element but may also be indirectly coupled to the second element via one or more third elements. Further, elements that are not essential to a complete understanding are omitted for clarity. Also, like reference numerals refer to like elements throughout.

**[0030]** In order to increase the life of an organic light emitting display, some embodiments use an inorganic

sealing material that effectively prevents moisture and/or oxygen from penetrating. However, when an inorganic sealing material is used, mechanical reliability deteriorates in some embodiments.

**[0031]** Therefore, some embodiments provide a light emitting display capable of increasing a life and of improving mechanical reliability using an inorganic sealing material that effectively prevents moisture and/or oxygen from penetrating and a method of manufacturing the same.

**[0032]** FIG. 1 is a perspective view illustrating an embodiment of a light emitting display. FIG. 2 is a cross-sectional view taken along section line I1-I2 of FIG. 1.

**[0033]** Referring to FIGS. 1 and 2, the light emitting display includes a substrate 100 on which a plurality of light emitting devices 130 is formed, a sealing substrate 200 facing the substrate 100, a dam member 220 provided between the substrate and the sealing substrate 200, which surrounds the plurality of light emitting devices 130, an inorganic sealing material 210 provided between the substrate 100 and the sealing substrate 200 outside the dam member 220, which couples the substrate 100 with the sealing substrate 200, an a filling material 300 provided inside the dam member 220 to cover the plurality of light emitting devices 130.

**[0034]** The substrate 100 is divided into a pixel region 120 and a non-pixel region 140 around the pixel region 120. The plurality of light emitting devices 130 is formed in the pixel region 120 and a driving circuit 160 for driving the plurality of light emitting devices 130 is formed in the non-pixel region 140. The light emitting devices 130 can be formed of organic light emitting diodes (OLED) that include anode electrodes, organic thin layers, and cathode electrodes.

**[0035]** The sealing substrate 200 is provided to overlap the pixel region 120 and a part of the non-pixel region 140. In the case of a front emission type of display, the sealing substrate 200 can be formed of a transparent material such as glass. In the case of a rear emission type, the sealing substrate can be formed of an opaque material.

**[0036]** The inorganic sealing material 210 can comprise frit, which is melted by laser or infrared red (IR) rays to the substrate 100 and the sealing substrate 200. The inorganic sealing material 210 is provided between the substrate 100 and the sealing substrate 200 surrounding the light emitting devices 130 so that moisture and/or oxygen penetration from the outside is prevented and/or reduced.

**[0037]** The dam member 220 prevents the flow of the filling material 300 so that the shape of the filling material 300 is maintained. The dam member 220 an inorganic material or an organic material. Also, the dam member 220 reduces or prevents heat from being transmitted to the light emitting devices 130 when the inorganic sealing material 210 is attached to the substrate 100 and the sealing substrate 200.

**[0038]** When the dam member 200 comprises an in-

organic material or an organic material, frit can be used as the inorganic material. In this case, frit that transmits or reflects IR rays is used or a reflecting layer is formed on the surface of the dam member 220 using metal having a high reflectance in an IR region such as Au, Ag, Pt, and/or Al so that laser or IR radiation is reflected. In addition, epoxy, epoxy acrylate, urethane, urethane acrylate, urethane acrylic, allyl resin, silicone (such as bisphenol A type epoxy, cycloaliphatic epoxy resin, acrylic epoxy resin, allyl ether, allyl methacrylate, and phenyl silicone resin), aliphatic urethane acrylate, rubber, and combinations thereof can be used as the organic material.

**[0039]** The dam member 220 may contact the inorganic sealing material 210 or may be separated from the inorganic sealing material 210 by a predetermined distance. For example, the dam member 220 can contact the inorganic sealing material 210 when the dam member 220 comprises inorganic material, and can be separated from the inorganic sealing material 210 by about 50  $\mu\text{m}$  when the dam member 220 comprises organic material.

**[0040]** When the dam member 220 comprising an organic material contacts the inorganic sealing material 210, in some embodiments, the dam member 220 is thermally decomposed when the inorganic sealing material 210 is attached to the substrate 100 and the sealing substrate 200, thereby generating out gas.

**[0041]** The filling material 300 is provided on the internal side of the region defined by the dam member 220 to cover the light emitting devices 130. In the illustrated embodiment, the filling material 300 is provided between the light emitting devices 130 and the sealing substrate 200 to contact the dam member 220 and the sealing substrate 200. The filling material 300 can comprise a colorless solid or liquid material having a transmittance of no less than about 95% within a thickness of about 30  $\mu\text{m}$ .

**[0042]** For example, the solid material can comprise at least one of epoxy, epoxy acrylate, urethane, urethane acrylate, urethane acrylic, allyl resin, silicone (such as bisphenol A type epoxy, cycloaliphatic epoxy resin, acrylic epoxy resin, allyl ether, allyl methacrylate, and phenyl silicone resin), aliphatic urethane acrylate, and rubber. After a liquid material is filled therein, it may be hardened by heat, electron beam, or UV radiation. In some embodiments, the liquid material is molded into a film which is attached to the solid material.

**[0043]** In addition, a liquid material can be silicone or silicone oil that exhibits no change in phase and a volume change ratio within 5% at temperatures ranging from about -40  $^{\circ}\text{C}$  to about 100  $^{\circ}\text{C}$ , for example, comprising at least one material selected from the group consisting of hexamethyldisiloxane, octamethyltrisiloxane, decamethyltetrasiloxane, dodecamethylpentasiloxane, polydimethylsiloxane, etc.

**[0044]** A method of manufacturing a light emitting display will now be described in detail.

**[0045]** FIGS. 3A and 3B are plan views illustrating an embodiment of a method of manufacturing the light emit-

ting display. FIGS. 4A to 4F are cross-sectional views illustrating the embodiment of the method of manufacturing the light emitting display. FIGS. 4A to 4D are cross-sectional views taken along section line 111-112 of FIG. 3B.

**[0046]** Referring to FIG. 3A, first, the substrate 100 on which the plurality of light emitting devices 130 is formed is provided. The substrate is divided into the pixel region 120 and the non-pixel region 140 around the pixel region 120. The plurality of light emitting devices 130 can be formed in the pixel region 120 of the substrate and the driving circuit 160 for driving the light emitting devices 130 can be formed in the non-pixel region 140.

**[0047]** The light emitting devices 130 comprise the OLED including the anode electrodes, the organic thin layers, and the cathode electrodes. The light emitting devices 130 can further include thin film transistors (TFT) for controlling the operation of the OLEDs and capacitors for maintaining signals. Processes of manufacturing the OLED are illustrated in the Korean Patent Publication Nos. 2002-0047889 (published on June 22, 2002) and 2003-0092873 (published December 6, 2003), the entire disclosures of which are incorporated by reference.

**[0048]** Referring to FIGS. 3B and 4A, the sealing substrate 200 for sealing the light emitting devices 130 of the pixel region 120 is provided. The sealing substrate 200 can overlap the pixel region 120 and a part of the non-pixel region 140. A transparent substrate such as glass having the front emission structure or an opaque substrate having the rear emission type can be used as the sealing substrate 200.

**[0049]** An inorganic sealing material 210 is disposed on the outer circumference of the sealing substrate 200. The inorganic sealing material 210 can comprise frit using dispensers and/or using a screen printing method. Frit commonly means the powder-type raw material of glass. However, as used herein, frit refers to a paste comprising a laser or IR ray absorbing material, an organic binder, and a filler for reducing a thermal expansion coefficient, to a main material such as SiO<sub>2</sub>. After a drying or annealing process, the organic binder and moisture are removed from the paste frit so that the paste frit is hardened. Laser or IR ray absorbing material can include a transition metal compound, for example, a vanadium compound.

**[0050]** After the inorganic sealing material 210 is disposed on the internal side of the sealing substrate 200, a washing process can be performed.

**[0051]** Referring to FIGS. 3B, 4B, and 4C, the dam member 220 is disposed on the sealing substrate 200 on the inward or internal side of the inorganic sealing material 210, thereby surrounding the pixel region 120. The dam member 220 can comprise an inorganic material and/or an organic material, and is applied by any suitable method, for example using dispensers or by screen printing. At this time, the amount of the inorganic material and/or organic material is determined in consideration of the distance from the light emitting devices 130 on the

outermost circumference of the pixel region to the inorganic sealing material 210 and the height of the dam member 220. The height of the dam member 220 can be determined by the height of the inorganic sealing material 210 so that the height of the inorganic sealing material 210 is about equal to or less than the height of the dam member 220.

**[0052]** Frit can be used as the inorganic material. In this case, the dam member 220 can be formed in a process of forming the inorganic sealing material 210. Frit that transmits or reflects laser or IR rays is used or a reflecting layer 222 is disposed on the surface of the dam member 220 in order to reflect laser or UV rays as illustrated in FIG. 4B. For example, after applying the paste frit, the paste frit is dried or annealed, and hardened to form the dam member 220. Then, the metal such as Au, Ag, Pt, and/or Al having a high reflectance in the UV ray region is applied onto the surface of the dam member 220 to form the reflecting layer 222. In addition, the organic material can be at least one of epoxy, epoxy acrylate, urethane, urethane acrylate, urethane acrylic, allyl resin, silicone (such as bisphenol A type epoxy, cycloaliphatic epoxy resin, acrylic epoxy resin, allyl ether, allyl methacrylate, and phenyl silicone resin), aliphatic urethane acrylate, and rubber.

**[0053]** The dam member 220 can contact the inorganic sealing material 210 as illustrated in FIG. 4B or can be separated from the inorganic sealing material 210 by a predetermined distance as illustrated in FIG. 4C. For example, when the dam member 220 is comprises an inorganic material, the dam member 220 can contact the inorganic sealing material 210. In this case, the area of the non-pixel region can be reduced. In addition, when the dam member comprises an organic material, the dam member 220 is separated from the inorganic sealing material 210 by no less than about 50 μm. Since the organic material typically has viscosity of not more than about 1,000,000 cps to be easily applied, the dam member 220 can be easily collapsed by stress such as a difference in pressure. Therefore, the dam member 220 can be hardened by heat, electron beam, or UV radiation in accordance with the kind of the organic material so that the dam member 220 is not damaged by the stress in a process of attaching the substrate 100 to the sealing substrate 200.

**[0054]** In another embodiment, in a process of forming the inorganic sealing material 210 or the dam member 220, a dummy sealing material (not shown) can be formed of epoxy and frit on the outermost circumference of the sealing substrate 200. The dummy sealing material is formed on the outside of the sealing material 210 to collectively seal up the space between the substrate 100 and the sealing substrate 200. In the case of a mother substrate on which a plurality of light emitting displays is simultaneously manufactured, the dummy sealing material is disposed on the outermost circumference thereof.

**[0055]** Referring to FIG. 4D, the filling material 300 is disposed on the sealing substrate 200 on the inward or

internal side of the region defined by the dam member 220. The filling material 300 can comprise a colorless solid or liquid material having a thickness of less than about 30  $\mu\text{m}$  and a transmittance of not less than about 95%. For example, the solid material can be selected from epoxy, epoxy acrylate, urethane, urethane acrylate, urethane acrylic, allyl resin, silicone (such as bisphenol A type epoxy, cycloaliphatic epoxy resin, acrylic epoxy resin, allyl ether, allyl methacrylate, and phenyl silicone resin), aliphatic urethane acrylate, rubber, and combinations thereof. The liquid material can be a silicone or silicone oil that exhibits no change in phase and a volume change ratio within about 5% in the temperature range of from about  $-40\text{ }^{\circ}\text{C}$  to about  $100\text{ }^{\circ}\text{C}$  such as hexamethyldisiloxane, octamethyltrisiloxane, decamethyltetrasiloxane, dodecamethylpentasiloxane, polydimethylsiloxane, or etc. After the sealing substrate 200 is filled with the filling material 300, the filling material 300 is cured and hardened by heat, electron beam, and/or UV radiation.

**[0056]** For example, the proper amount of liquid filling material 300 can be applied to the sealing substrate 200 on the internal side of the dam member 220 using a one drop filling (ODF) device. In this case, the proper amount of filling material 300 in proportion to the volume of the internal space can be easily controlled.

**[0057]** Referring to FIG. 4E, the substrate 100 is disposed facing the sealing substrate 200. For example, after the substrate 100 is mounted on an upper chuck of an attaching device and the sealing substrate 200 is mounted on a lower chuck of the attaching device, the substrate 100 and the sealing substrate 200 are attached to each other. As the substrate 100 and the sealing substrate 200 are attached to each other, the light emitting devices 130 are covered with the filling material 300 and the flow of the filling material 300 is prevented by the dam member 220 so that the shape is maintained. At this time, the substrate 100 and the sealing substrate 200 are attached to each other under a pressure lower than atmospheric pressure, for example, from about 1 Pa to about 100,000 Pa so that bubbles and/or voids are not formed between the substrate 100 and the sealing substrate 200. In addition, the substrate 100 and the sealing substrate 200 are pressed together so that the space between the light emitting devices 130 and the sealing substrate 200 is completely filled with the filling material 300. The filling material 300 can be hardened by heat, electron beam, or UV radiation after the substrate 100 and the sealing substrate 200 are attached to each other.

**[0058]** Referring to FIG. 4F, laser and/or IR radiation are projected onto the inorganic sealing material 210 after the substrate 100 and the sealing substrate 200 are attached to each other. As the laser or IR rays are absorbed to generate heat, the inorganic sealing material 210 is attached to the substrate 100 and the sealing substrate 200 by melting, so that the light emitting devices 130 are sealed. Such a sealing process is performed after the dummy sealing material is hardened so that the

space between the substrate 100 and the sealing substrate 200 is maintained.

**[0059]** When laser or IR radiation are projected onto the inorganic sealing material 210, a mask or a protecting film (not shown) is used so that laser or IR radiation are projected onto only a desired region. When the dam member 220 comprises an inorganic material that transmits or reflects laser or IR radiation, or the reflecting layer 222 is disposed on the surface of the dam member 220, the mask or the protecting film is disposed only in the pixel region 120 so that laser or IR radiation are not projected thereon. When the dam member 220 comprises an organic material, the mask or the protecting film is disposed in the pixel region 120 and the non-pixel region 140 where the dam member 220 is formed so that laser or IR rays does not projected thereon.

**[0060]** In some embodiments lacking a dam member 220, since the heat generated in irradiating with laser or IR radiation is easily transmitted to the filling material 300, the temperature can instantaneously rise, thereby melting the filling material 300. However, the transmission of heat is effectively reduced or prevented by the dam member 220, thereby thermally protecting the filling material 300.

**[0061]** According to the above embodiment, the inorganic sealing material 210 seals only the pixel region 120. In other embodiments, the inorganic sealing material 210 can also seal the driving circuit 160. In addition, according to the above embodiment, the inorganic sealing material 210 and the dam member 220 are integrated with each other on the sealing substrate 200. In other embodiments, the inorganic sealing material and the dam member can be integrated with each other on the substrate 100 to have a double or multiple structure. For example, in order to improve sealing effect, the inorganic sealing material 210 can comprise a double or multiple structure, and/or the dam member 220 comprise a double or multiple structure in order to improve heat shielding effect.

**[0062]** In addition, according to the above embodiment, the filling material 300 is filled before attaching the substrate 100 and the sealing substrate 200 to each other. However, the filling material 300 can be filled after the substrate 100 and the sealing substrate 200 are attached to each other in accordance with the material.

**[0063]** As an another embodiment, the curing of the filling material 300 dropped on the internal side of the dam member 220 is initiated by heat, electron beam, and/or UV before attaching the substrate 100 and the sealing substrate 200 to each other, and is completely cured and hardened after attaching the substrate 100 and the sealing substrate 200 to each other.

**[0064]** As described above, an inorganic sealing material that effectively shields moisture and/or oxygen seals the light emitting devices so that the life of the light emitting display is increased, and the space between the substrates is filled with the filling material so that mechanical reliability is improved.

**[0065]** In typical light emitting displays, since the space between the substrate and the sealing substrate is empty, the substrate can move, thereby generating Newton's ring and/or increasing the shock sensitivity of the light emitting display. On the other hand, according to some embodiments of the light emitting display, the space between the substrate and the sealing substrate is filled with a filling material with a similar refractivity to the refractivity of the glass substrate, thereby reducing or preventing Newton's ring. Therefore, visibility is improved and a voltage tolerance characteristic between the substrates is improved so that the seal is not as easily damaged by shock.

**[0066]** Although a number of embodiments have been shown and described, those skilled in the art will appreciate that changes might be made in these embodiments without departing from the principles thereof, the scope of which is defined in the claims and their equivalents.

### Claims

1. A light emitting display comprising:

a first substrate comprising a plurality of light emitting devices disposed thereon;

a second substrate facing the plurality of light emitting devices disposed on the first substrate; a dam member disposed between the first substrate and the second substrate, the dam member being arranged to surround the plurality of light emitting devices;

an inorganic sealing material arranged to secure the first substrate and the second substrate to each other, the inorganic sealing material being disposed between the first substrate and the second substrate and around an outer circumference of the dam member to attach the first substrate and the second substrate; and

a filling material disposed inward of the dam member and between the first substrate and the second substrate, covering the plurality of light emitting devices.

2. A light emitting display according to claim 1, wherein the dam member comprises an inorganic material.

3. A light emitting display according to claim 2, wherein the inorganic material comprises frit.

4. A light emitting display according to claim 2 or 3, wherein a reflecting layer arranged to reflect laser and/or infrared (IR) radiation is disposed on a surface of the dam member.

5. A light emitting display according to claim 4, wherein the reflecting layer comprises at least one of Au, Ag, Pt, and Al.

6. A light emitting display according to any one of claims 2 to 5, wherein at least a portion of the dam member is arranged to contact the inorganic sealing material.

5 7. A light emitting display according to claim 1, wherein the dam member comprises an organic material.

8. A light emitting display according to claim 7, wherein the organic material comprises at least one of epoxy, epoxy acrylate, urethane, urethane acrylate, urethane acrylic, allyl resin, silicone, bisphenol A type epoxy silicone, cycloaliphatic epoxy silicone resin, acrylic epoxy silicone resin, allyl ether silicone, allyl methacrylate silicone, phenyl silicone resin, aliphatic urethane acrylate, and rubber.

9. A light emitting display according to claim 7 or 8, wherein the dam member does not contact the inorganic sealing material.

20

10. A light emitting display according to any one of claims 1 to 9, wherein the inorganic sealing material comprises frit.

25 11. A light emitting display according to claim 10, wherein the frit is meltable by laser and/or IR radiation.

12. A light emitting display according to claim 11, wherein the frit comprises a transition metal compound.

30

13. A light emitting display according to any one of claims 1 to 12, wherein the filling material is arranged to fill at least some of a space between the plurality of light emitting devices and the second substrate inward of the dam member.

35

14. A light emitting display according to any one of claims 1 to 13, wherein the filling material comprises a solid material.

40

15. A light emitting display according to claim 14, wherein the filling material comprises a heat, electron beam, and/or UV radiation hardening material.

45 16. A light emitting display according to claim 15, wherein the filling material comprises at least one of epoxy, epoxy acrylate, urethane, urethane acrylate, urethane acrylic, allyl resin, silicone, bisphenol A type epoxy silicone, cycloaliphatic epoxy silicone resin, acrylic epoxy silicone resin, allyl ether silicone, allyl methacrylate silicone, phenyl silicone resin, aliphatic urethane acrylate, and rubber.

50

17. A light emitting display according to any one of claims 1 to 13, wherein the filling material comprises a liquid material.

55

18. A light emitting display according to claim 17, where-

in the filling material comprises silicone and/or silicone oil.

- 19.** A light emitting display according to claim 17, wherein the filling material comprises at least one of hexamethyldisiloxane, octamethyltrisiloxane, decamethyltetrasiloxane, dodecamethylpentasiloxane, and polydimethylsiloxanes. 5
- 20.** A method of manufacturing a light emitting display comprising: 10
- providing a first substrate comprising a plurality of light emitting devices are formed;
  - providing a second substrate facing the plurality of light emitting devices disposed on the first substrate; 15
  - disposing an inorganic sealing material on an outer circumference of the second substrate;
  - disposing a dam member on the second substrate inward of the inorganic sealing material so as to surround the plurality of light emitting devices; 20
  - disposing a filling material inward of the dam member; and 25
  - securing the inorganic sealing material to the first substrate and the second substrate, thereby sealing the plurality of light emitting devices.
- 21.** A method according to claim 20, wherein disposing the inorganic sealing material comprises: 30
- applying frit paste; and
  - drying and/or annealing the frit paste. 35
- 22.** A method according to claim 20, wherein disposing the dam member comprises: 40
- applying frit paste; and
  - drying and/or annealing the frit paste, thereby hardening the frit paste. 45
- 23.** A method according to claim 22, wherein at least a portion of the dam member is arranged to contacts the inorganic sealing material. 45
- 24.** A method according to claim 20, wherein disposing the dam member comprises: 50
- applying a liquid organic material, wherein the liquid organic material does not contact the inorganic sealing material; and
  - hardening the liquid organic material. 50
- 25.** A method according to any one of claims 20 to 24, wherein securing the inorganic sealing material to the first substrate and the second substrate to face each other is performed at a pressure lower than 55

atmospheric pressure.

- 26.** A method according to claim 25, wherein the pressure is from about 1 Pa to about 10,000 Pa.
- 27.** A method according to any one of claims 20 to 26, wherein the filling material is a liquid, the method further comprising compressing the first substrate and the second substrate, thereby filling with the liquid filling material spaces between the light emitting devices and the second substrate within the dam member.
- 28.** A method according to any one of claims 20 to 26, wherein the filling material is a liquid, the method further comprising hardening the liquid filling material.
- 29.** A method according to any one of claims 20 to 28, wherein securing the inorganic sealing material to the first substrate and the second substrate comprises melting the inorganic sealing material.
- 30.** A method according to claim 32, wherein the inorganic sealing material is melted by laser and/or IR radiation.

FIG. 1

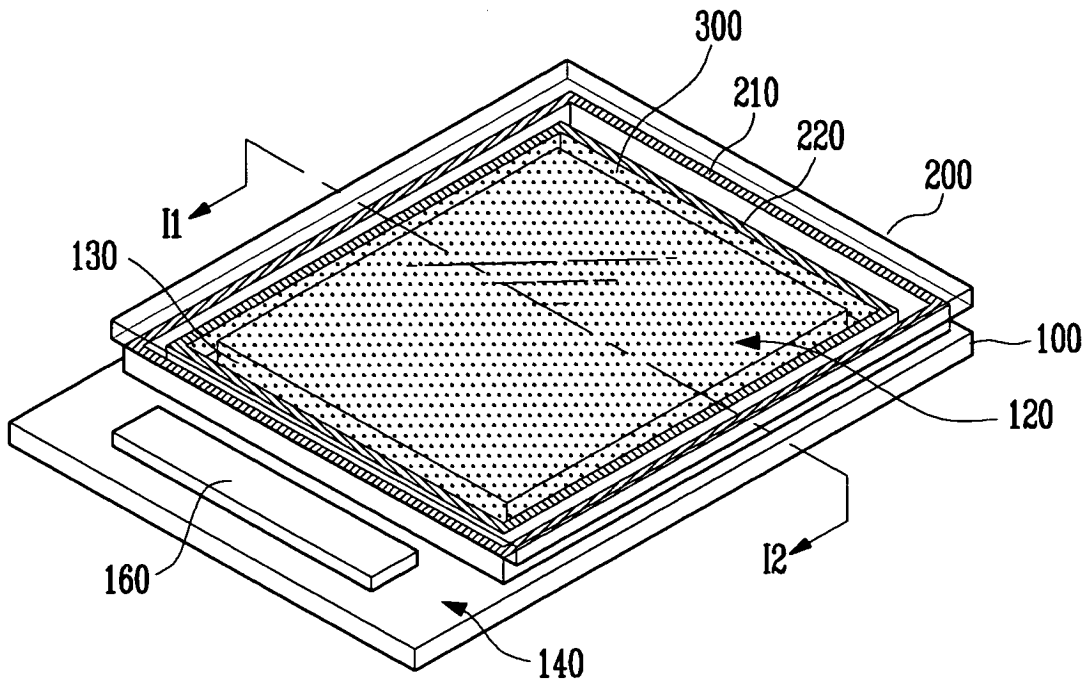

FIG. 2

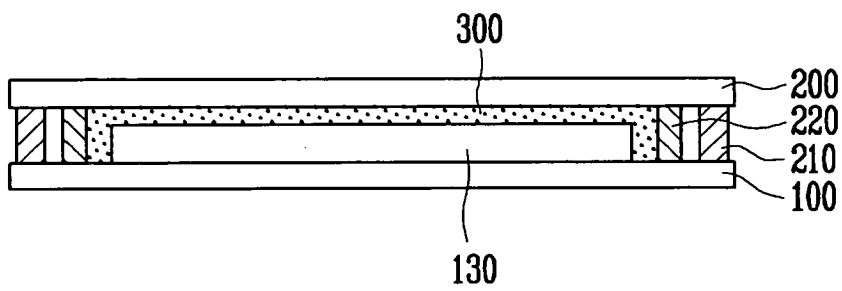

FIG. 3A

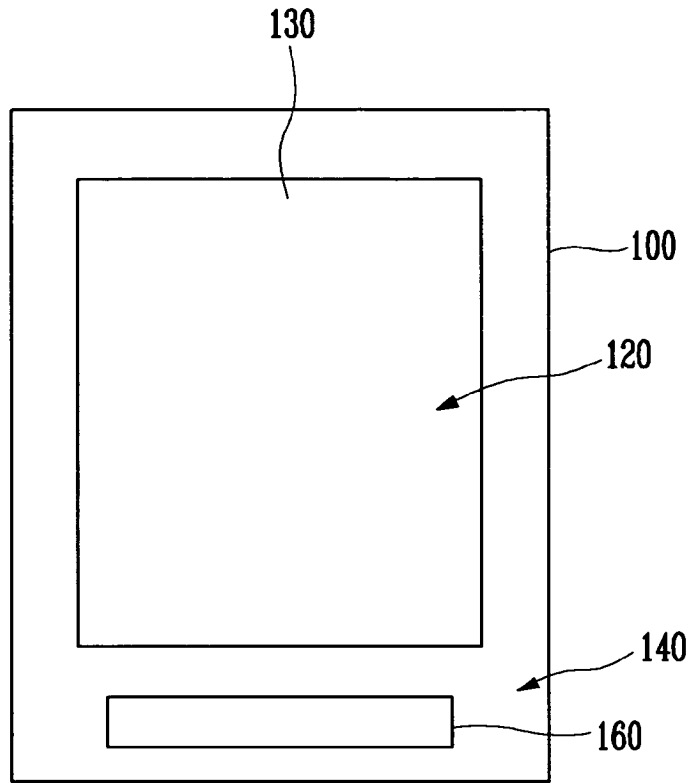

FIG. 3B

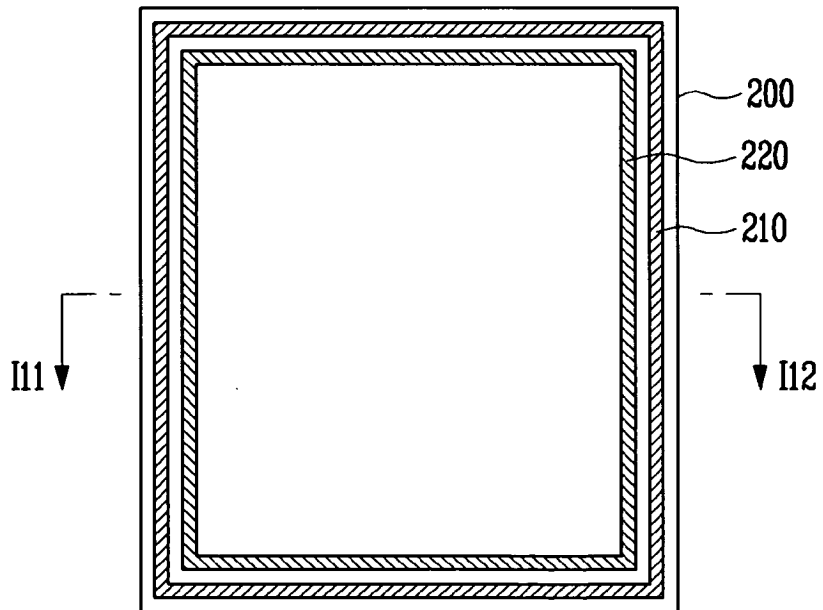

FIG. 4A

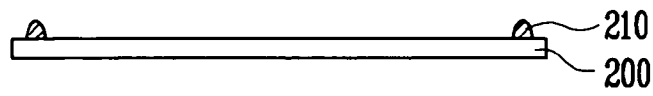

FIG. 4B

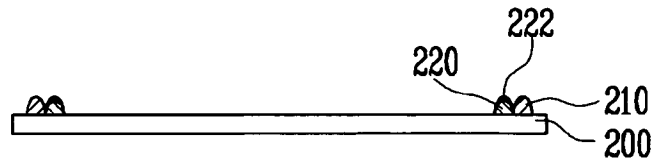

FIG. 4C

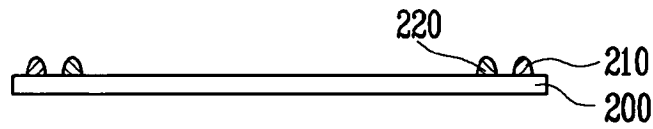

FIG. 4D

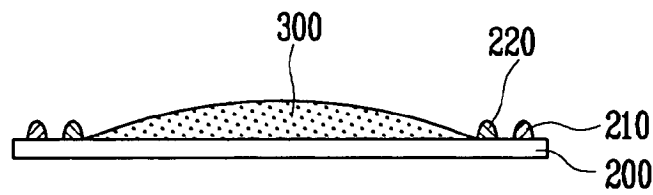

FIG. 4E

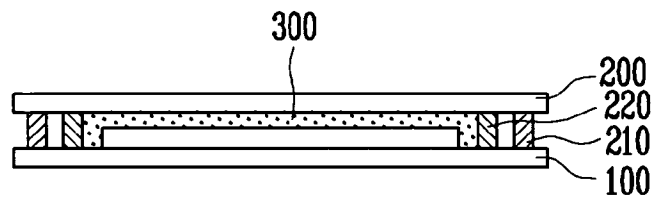
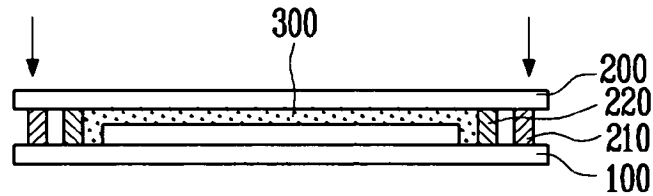

FIG. 4F



**REFERENCES CITED IN THE DESCRIPTION**

*This list of references cited by the applicant is for the reader's convenience only. It does not form part of the European patent document. Even though great care has been taken in compiling the references, errors or omissions cannot be excluded and the EPO disclaims all liability in this regard.*

**Patent documents cited in the description**

- KR 20020047889 [0047]
- KR 20030092873 [0047]

专利名称(译)	发光显示器及其制造方法		
公开(公告)号	<a href="#">EP2009715A2</a>	公开(公告)日	2008-12-31
申请号	EP2008252229	申请日	2008-06-27
[标]申请(专利权)人(译)	三星斯笛爱股份有限公司		
申请(专利权)人(译)	三星SDI CO. , LTD.		
当前申请(专利权)人(译)	三星SDI CO. , LTD.		
[标]发明人	OH MIN HO CHO YOON HYEUNG LEE BYOUNG DUK LEE SO YOUNG LEE SUN YOUNG KIM WON JONG CHOI JIN BAEK LEE JONG HYUK LEE SEUNG HAN KIM YONG TAK		
发明人	OH, MIN-HO CHO, YOON-HYEUNG LEE, BYOUNG-DUK LEE, SO-YOUNG LEE, SUN-YOUNG KIM, WON-JONG CHOI, JIN-BAEK LEE, JONG-HYUK LEE, SEUNG-HAN KIM, YONG-TAK		
IPC分类号	H01L51/52 G09F9/00 G09F9/30 H01L27/32 H01L51/50 H05B33/04 H05B33/10		
CPC分类号	H01L51/5246 H01L51/56		
优先权	1020070064293 2007-06-28 KR		
其他公开文献	EP2009715A3 EP2009715B1		
外部链接	<a href="#">Espacenet</a>		

#### 摘要(译)

一种发光显示器及其制造方法，其中所述发光显示器包括：第一基板，其上形成有多个发光器件；第二基板，设置为面对所述第一基板；坝构件，设置在所述第一基板之间第二基板包围多个发光装置，无机密封材料设置在第一基板和第二基板之间，位于阻挡构件的外周上，以将第一基板和第二基板彼此连接，以及填充物材料设置在阻挡构件的内侧以覆盖多个发光器件。无机密封材料有效地屏蔽水分或氧气和/或增加发光显示器的寿命。填充材料填充基板之间的空间以提高机械可靠性。

FIG. 2

