



(11) **EP 3 648 168 A1**

(12) **EUROPEAN PATENT APPLICATION**  
published in accordance with Art. 153(4) EPC

(43) Date of publication:  
**06.05.2020 Bulletin 2020/19**

(51) Int Cl.:  
**H01L 27/32** <sup>(2006.01)</sup> **H01L 27/02** <sup>(2006.01)</sup>  
**H01L 21/77** <sup>(2017.01)</sup>

(21) Application number: **18825345.4**

(86) International application number:  
**PCT/CN2018/087965**

(22) Date of filing: **23.05.2018**

(87) International publication number:  
**WO 2019/001177 (03.01.2019 Gazette 2019/01)**

(84) Designated Contracting States:  
**AL AT BE BG CH CY CZ DE DK EE ES FI FR GB GR HR HU IE IS IT LI LT LU LV MC MK MT NL NO PL PT RO RS SE SI SK SM TR**  
Designated Extension States:  
**BA ME**  
Designated Validation States:  
**KH MA MD TN**

(72) Inventors:  
• **KO, Youngyik**  
**Beijing 100176 (CN)**  
• **TAN, Wen**  
**Beijing 100176 (CN)**  
• **HUANG, Weiyun**  
**Beijing 100176 (CN)**  
• **WANG, Benlian**  
**Beijing 100176 (CN)**

(30) Priority: **29.06.2017 CN 201710516966**

(71) Applicants:  
• **BOE Technology Group Co., Ltd.**  
**Beijing 100015 (CN)**  
• **Chengdu BOE Optoelectronics Technology Co., Ltd.**  
**Chengdu, Sichuan 611731 (CN)**

(74) Representative: **Gesthuysen Patent- und Rechtsanwälte**  
**Patentanwälte**  
**Huysenallee 100**  
**45128 Essen (DE)**

(54) **ORGANIC ELECTROLUMINESCENT DISPLAY PANEL AND MANUFACTURING METHOD THEREFOR, AND DISPLAY DEVICE**

(57) The present disclosure relates to an organic electroluminescence display panel, a fabricating method thereof, and a corresponding display device. The organic electroluminescence display panel includes: a base substrate including a display area; a gate driving circuit and a plurality of pixel driving circuits located in the display area; and a plurality of top emission type of light-emitting units located in the display area. An orthographic projection of the gate driving circuit on the base substrate at least partially overlaps with an orthographic projection of the plurality of top emission type of light-emitting units on the base substrate.

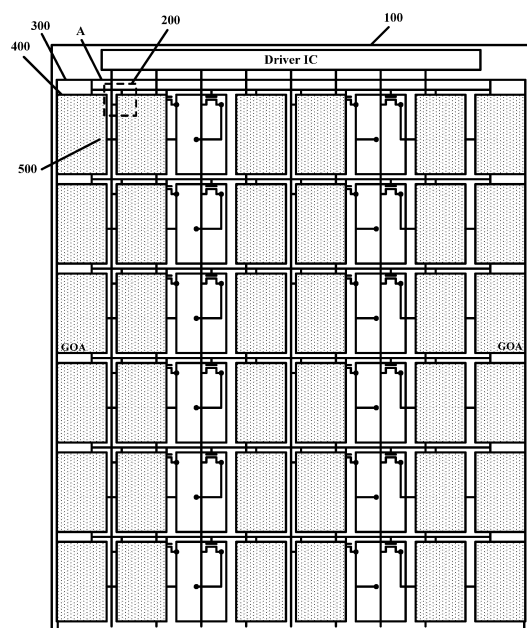

Fig. 4

**EP 3 648 168 A1**

## Description

### RELATED APPLICATION(s)

[0001] The present application claims the benefit of Chinese Patent Application No. 201710516966.4, filed on June 29, 2017, the entire disclosure of which is incorporated herein by reference.

### TECHNICAL FIELD

[0002] The present disclosure relates to the field of display technology, and discloses specifically an organic electroluminescence display panel, a fabricating method thereof, and a display device.

### BACKGROUND

[0003] In a conventional display panel, the display area is generally located in the middle of panel, and the gate driving circuit is located near the frame of panel. In this way, adverse effects on the display area due to the gate driving circuit are avoided. However, such an arrangement of gate driving circuit at the frame tends to result in display panels and subsequent display products with wider frames.

[0004] Therefore, with the increasing popularity of narrow frames and even frameless designs, it has been proposed to move the gate driving circuit from the frame area to the display area, for example, into the pixel area, so as to narrow down and even eliminate the frame. However, in a specific implementation, it is extremely difficult to dispose a gate driving circuit in the display. For OLED products, especially high-resolution OLED products, it is very difficult to dispose further the gate driving circuit in a limited display area, since the complicated pixel driving circuit has been disposed in the same display area.

### SUMMARY

[0005] According to an aspect of the present disclosure, an embodiment provides an organic electroluminescence display panel. The organic electroluminescence display panel comprises: a base substrate having a display area; a gate driving circuit and a plurality of pixel driving circuits located in the display area; and a plurality of top emission type of light-emitting units located in the display area. Further, in the above organic electroluminescence display panel, an orthographic projection of the gate driving circuit on the base substrate at least partially overlaps with an orthographic projection of the plurality of top emission type of light-emitting units on the base substrate.

[0006] According to a possible implementation, in the above organic electroluminescence display panel provided by an embodiment of the present disclosure, the orthogonal projection of the gate driving circuit on the base substrate does not overlap with an orthogonal pro-

jection of the plurality of pixel driving circuits on the base substrate.

[0007] According to a possible implementation, in the above organic electroluminescence display panel provided by an embodiment of the present disclosure, each of the top emission type of light-emitting units comprises an anode, a light-emitting layer and a cathode that are sequentially stacked, wherein the anode is connected to a respective pixel driving circuit.

[0008] According to a possible implementation, in the above organic electroluminescence display panel provided by an embodiment of the present disclosure, the anode of each of the top emission type of light-emitting units is connected to a respective pixel driving circuit by a connection line.

[0009] According to a possible implementation, in the above organic electroluminescence display panel provided by an embodiment of the present disclosure, the connection line is located between a first film layer where the respective top emission type of light-emitting unit is located and a second film layer where the respective pixel driving circuit is located.

[0010] According to a possible implementation, in the above organic electroluminescence display panel provided by an embodiment of the present disclosure, the gate driving circuit is located at an edge of the display area of the base substrate.

[0011] According to a possible implementation, in the above organic electroluminescence display panel provided by an embodiment of the present disclosure, the gate driving circuit comprises a gate sub-driving circuit located at an edge of the display area of the base substrate. Alternatively, in other implementations, the gate driving circuit comprises a first gate sub-driving circuit and a second gate sub-driving circuit located respectively at two opposite edges of the display area of the base substrate.

[0012] According to a possible implementation, in the above organic electroluminescence display panel provided by an embodiment of the present disclosure, the gate driving circuit is located between two adjacent pixel driving circuits.

[0013] According to another aspect of the present disclosure, an embodiment further provides a display device, comprising the above organic electroluminescence display panel according to embodiments of the present disclosure.

[0014] According to yet another aspect of the present disclosure, an embodiment further provides a fabricating method for the above organic electroluminescence display panel. The fabricating method comprises steps of: fabricating a gate driving circuit and a plurality of pixel driving circuits in a display area of a base substrate, wherein an orthogonal projection of the gate driving circuit on the base substrate does not overlap with an orthogonal projection of the plurality of pixel driving circuits on the base substrate; and fabricating further a plurality of top emission type of light-emitting units in the display

area of the base substrate, wherein the plurality of top emission type of light-emitting units at least partially cover the plurality of pixel driving circuits and the gate driving circuit, and an orthographic projection of the gate driving circuit on the base substrate at least partially overlaps with an orthographic projection of the plurality of top emission type of light-emitting units on the substrate.

**[0015]** According to a possible implementation, in an embodiment of the present disclosure, the fabricating method for the above organic electroluminescence display panel also comprises steps of: after fabricating the gate driving circuit and the plurality of pixel driving circuits in the display area of the base substrate, and before fabricating further the plurality of top emission type of light-emitting units in the display area of the base substrate, fabricating connection lines, wherein the connection lines are configured to connect respectively an anode of each of the top emission type of light-emitting units to a respective pixel driving circuit.

### **BRIEF DESCRIPTION OF THE DRAWINGS**

#### **[0016]**

Fig. 1 is a schematic structural diagram of a display panel according to a conventional approach;

Fig. 2 is a schematic diagram showing a circuit structure of a shift register in the display panel of Fig. 1;

Fig. 3 is a schematic diagram showing a circuit structure of a shift register located in a display area according to another conventional approach;

Figs. 4-6 are respectively schematic structural diagrams of organic electroluminescence display panels according to embodiments of the present disclosure; and

Fig. 7 schematically shows a simplified cross-sectional view of a hierarchical relationship between a connection line, a top emission type of light-emitting unit, and a pixel driving circuit in an organic electroluminescence display panel according to an embodiment of the present disclosure.

### **DETAILED DESCRIPTION OF THE DISCLOSURE**

**[0017]** Specific implementations of the organic electroluminescence display panel, the fabricating method thereof and the display device provided by embodiments of the present disclosure will be described in detail below with reference to the accompanying drawings.

**[0018]** It should be noted that the thickness and shape of various film layers in the drawings do not represent any real proportion in the organic electroluminescence display panel, and are merely intended to illustrate the present disclosure.

**[0019]** As shown in Fig. 1, according to a conventional approach, a gate line 01, a data line 02, and a pixel unit 03 are disposed in a display area A of a display panel, wherein the pixel unit is disposed in an area defined by the gate line 01 and the data line 02. Also, a gate driving circuit for driving the gate line 01 is provided at the left and right frames. Specifically, the gate driving circuit consists of a plurality of cascaded shift registers, wherein each shift register is composed of at least four switching transistors T1, T2, T3, and T4, and a circuit structure diagram thereof is shown in Fig. 2.

**[0020]** As mentioned above, for the purpose of narrowing down the frame of display panel and even realizing a frameless design, it has been proposed to use the approach as shown in Fig. 3, in which the gate driving circuit that was located otherwise in the frame area is moved now to the pixel area. In this way, the space for disposing the gate driving circuit at the frame is eliminated, thereby realizing an ultra-narrow frame or even a frameless design. However, in actual operations, it is difficult to dispose a gate driving circuit in the display area. In particular, for OLED products, the difficulty is further increased, because in OLED products, especially in high-resolution OLED products, complex pixel circuits have already been disposed in the size-limited display area.

**[0021]** According to an embodiment of the present disclosure, an organic electroluminescence display panel is provided. As shown in Figs. 4-6, the organic electroluminescence display panel comprises: a base substrate 100; a plurality of pixel driving circuits 200 and a gate driving circuit 300 disposed in the display area A of the base substrate 100; and a plurality of top emission type of light-emitting units 400 disposed in the display area A of the base substrate 100 and covering the plurality of pixel driving circuits 200 and the gate driving circuit 300. Further, an orthographic projection of the gate driving circuit 300 on the base substrate 100 does not overlap with an orthographic projection of the plurality of pixel driving circuits 200 on the base substrate 100. Besides, the orthographic projection of the gate driving circuit 300 on the base substrate 100 at least partially overlaps with an orthographic projection of the plurality of top emission type of light-emitting units 400 on the base substrate 100.

**[0022]** Specifically, in the above organic electroluminescence display panel provided by an embodiment of the present disclosure, the gate driving circuit 300 and the pixel driving circuits 200 are simultaneously disposed in the display area A of the base substrate 100, and also it is ensured that the orthographic projection of the gate driving circuit 300 on the base substrate 100 does not overlap with the orthographic projection of the pixel driving circuits 200 on the base substrate 100. That is, the switching transistors in the gate driving circuit 300 are not disposed inside the pixel driving circuit 200 as in Fig. 3, and thus will not occupy the wiring space of the pixel driving circuit 200. Therefore, it is ensured that both of the gate driving circuit 300 and the pixel driving circuit 200 have sufficient wiring spaces in the display area.

**[0023]** Meanwhile, in the above organic electroluminescence display panel provided by an embodiment of the present disclosure, a plurality of top emission type of light-emitting units 400, which is covering the pixel driving circuits 200 and the gate driving circuit 300, are further disposed in the display area A of the base substrate 100. In such a case, according to an embodiment of the present disclosure, the area occupied by each of the top emission type of light-emitting units is increased as compared with the conventional pixel unit (corresponding to the top emission type of light-emitting unit 400). Specifically, in the conventional approach, one of the top emission type of light-emitting units 400 only overlaps with one of the pixel driving circuits 200. That is, the conventional top emission type of light-emitting unit 400 is disposed in a region defined by the gate line and the data line. However, according to an embodiment of the present disclosure, the gate driving circuit 300 has an overlapping region with the top emission type of light-emitting units 400 in the display area A. That is, according to an embodiment of the present disclosure, the top emission type of light-emitting units 400 may span over the data lines, thereby ensuring that all circuits in the display area A are covered by the top emission type of light-emitting units 400. In this way, it is ensured that both of the gate driving circuit 300 and the pixel driving circuits 200 have sufficient wiring spaces in the display area A, thereby eliminating the need for arranging the gate driving circuit 300 at the frame, and thus realizing an ultra-narrow frame or even a frameless design.

**[0024]** According to a specific embodiment, in the above organic electroluminescence display panel provided by an embodiment of the present disclosure, each of the top emission type of light-emitting units 400 comprises generally an anode, a light-emitting layer, and a cathode that are sequentially stacked, wherein the anode is connected to a respective pixel driving circuit 200. In order to ensure light emission from the cathode side of each of the top emission type of light-emitting units 400, it is required that the cathode is made of light transmissive material. However, the anode may be generally fabricated by an opaque metal, or a reflective layer can be fabricated separately under a transparent anode. In addition, the top emission type of light-emitting unit 400 may further comprise a functional film layer, such as an electron transport layer, a hole transport layer, an electron blocking layer, and a hole blocking layer, and the present disclosure is not limited in this regard.

**[0025]** According to a specific embodiment, in the above organic electroluminescence display panel provided by an embodiment of the present disclosure, in order to ensure that light-emitting regions are distributed uniformly in the display area A, as shown in Figs. 4-6, anodes of each of the top emission type of light-emitting units 400 may be distributed uniformly in the display area A of the base substrate 100. That is, intervals between anodes of the top emission type of light-emitting units 400 keep the same.

**[0026]** According to a specific embodiment, in the above organic electroluminescence display panel provided by an embodiment of the present disclosure, in order to ensure that light-emitting regions are distributed uniformly in the display area A, as shown in Figs. 4-6, anodes of the top emission type of light-emitting units 400 can be configured to be the same in shape and size. Alternatively, when each of the top emission type of light-emitting units 400 is fabricated using a single color light-emitting layer, the light-emitting efficiency may be different depending on the material of the light-emitting layer in each of the top emission type of light-emitting units 400. Therefore, in a specific embodiment, it is also possible to set the area occupied by the light-emitting layer and the anode in each of the top emission type of light-emitting units 400 based on the light-emitting efficiency. That is, the area occupied by the top emission type of light-emitting unit 400 having high light-emitting efficiency is relatively small, and the area occupied by the top emission type of light-emitting unit 400 having low light-emitting efficiency is relatively large.

**[0027]** According to a specific embodiment, in the above organic electroluminescence display panel provided by an embodiment of the present disclosure, advantageously, as shown in Figs. 4-6, each of the top emission type of light-emitting units 400 is corresponding to a respective one of the pixel driving circuits 200, so as to drive the top emission type of light-emitting units 400 in a better way to emit light. That is, one pixel driving circuit 200 drives one of the top emission type of light-emitting units 400 to emit light. It is of course not excluded that one pixel driving circuit 200 drives a plurality of top emission type of light-emitting units 400 to emit light. In this case, since the area occupied by the top emission type of light-emitting unit 400 is increased, there may be a case where the top emission type of light-emitting unit 400 and its respective pixel driving circuit 200 do not directly overlap with each other. That is, for example, referring to Fig. 4, the top emission type of light-emitting units 400 in the leftmost column has an overlapping region only with the gate driving circuit 300. In view of above, as shown in Figs. 4-6, anodes of each of the top emission type of light-emitting units 400 need to be connected to their respective pixel driving circuits 200 by respective connection lines 500.

**[0028]** According to a specific embodiment, in the above organic electroluminescence display panel provided by an embodiment of the present disclosure, the connection lines 500 may be disposed in an existing conductive film layer, for example, disposed in the same layer as the gate lines, so as to reduce process steps. However, this will increase the complexity for wiring in the film. In view of above, advantageously, in the above organic electroluminescence display panel provided by an embodiment of the present disclosure, the connection lines 500 can be provided as a separate film layer. For example, referring to Fig. 7, which is a schematic diagram showing a hierarchical relationship between a connec-

tion line 500, a top emission type of light-emitting unit 400, and a pixel driving circuit 200 in an organic electroluminescence display panel according to an embodiment of the present disclosure. Specifically, the connection line 500 may be disposed between a first film layer 400' where the top emission type of light-emitting unit 400 is located and a second film layer 200' where the pixel driving circuit 200 is located. This means that in the above embodiment, the film layers to be patterned in the fabricating process of the organic electroluminescence display panel are respectively: active layer→gate insulating layer→gate metal layer→interlayer insulating layer→source-drain metal layer→planarization layer→anode→pixel defining layer→spacer layer. In contrast, for the organic electroluminescence display panel provided by embodiments of the present disclosure, two additional film layers are needed in the fabricating process. That is, the film layers will change to be respectively: active layer→gate insulating layer→gate metal layer→interlayer insulating layer→source-drain metal layer→insulating layer→connection line layer→planarization layer→anode→pixel defining layer→spacer layer.

**[0029]** According to a specific embodiment, in the above organic electroluminescence display panel provided by an embodiment of the present disclosure, the specific position for the gate driving circuit 300 in the display area A of the base substrate 100 is not limited, which may be determined based on the actual size of the display panel. For example, as shown in Fig. 4, the gate driving circuit 300 may be disposed at an edge of the display area A of the base substrate 100. Moreover, in the above organic electroluminescence display panel provided by an embodiment of the present disclosure, as shown in Fig. 4, the gate driving circuit 300 may comprise two gate sub-driving circuits, which are respectively disposed at two opposite edges of the display area of the base substrate 100, so as to achieve bilateral driving. In this way, problems such as signal delay in a large-sized panel can be alleviated. Of course, alternatively, the gate driving circuit 300 may be disposed only at any edge of the display area A.

**[0030]** According to a specific embodiment, in the above organic electroluminescence display panel provided by an embodiment of the present disclosure, as shown in Fig. 5, the gate driving circuit 300 may be disposed at a position between two adjacent pixel driving circuits 200. For example, in Fig. 5, the gate driving circuit 300 is disposed at an intermediate position of the display area A. Therefore, driving signals can be supplied at the same time to the gate lines at both sides, thereby contributing to a reduction of signal delay.

**[0031]** Obviously, the above content is merely for illustrating how to dispose the gate driving circuit 300 in the display area A of the above organic electroluminescence display panel provided by embodiments of the present disclosure, and the present disclosure is not limited thereto. For example, as shown in Fig. 6, a plurality of gate sub-driving circuits may be simultaneously disposed at

edge and intermediate position of the display area A, and they constitute together the gate driving circuit 300. Of course, the present disclosure is in no way limited in this respect.

**[0032]** Based on the same concept, embodiments of the present disclosure also provide a display device, comprising the organic electroluminescence display panel according to any of the above embodiments of the present disclosure. The display device can be any products or components having a display function, such as a mobile phone, a tablet computer, a television set, a display, a notebook computer, a digital photo frame, a navigator, and the like. For specific implementations of the display device, reference may be made to the embodiments of the above organic electroluminescence display panel, and the repeated description is omitted herein.

**[0033]** Based on the same concept, embodiments of the present disclosure also provide a fabricating method for the above organic electroluminescence display panel. The fabricating method comprises the steps of: fabricating a gate driving circuit and a plurality of pixel driving circuits in a display area of a base substrate, wherein an orthogonal projection of the gate driving circuit on the base substrate does not overlap with an orthogonal projection of the plurality of pixel driving circuits on the base substrate; and fabricating further a plurality of top emission type of light-emitting units in the display area of the base substrate, wherein the plurality of top emission type of light-emitting units at least partially cover the plurality of pixel driving circuits and the gate driving circuit, and an orthographic projection of the gate driving circuit on the base substrate at least partially overlaps with an orthographic projection of the plurality of top emission type of light-emitting units on the base substrate.

**[0034]** According to a specific embodiment, the above fabricating method provided by embodiments of the present disclosure may also comprise the following optional steps: after fabricating the gate driving circuit and the plurality of pixel driving circuits in the display area of the base substrate, and before fabricating further the plurality of top emission type of light-emitting units in the display area of the base substrate, fabricating connection lines for connecting an anode of each of the top emission type of light-emitting units to a respective pixel driving circuit.

**[0035]** For example, in the fabricating method for the organic electroluminescence display panel provided by embodiments of the present disclosure, the film layers to be patterned are respectively: active layer→gate insulating layer→gate metal layer→interlayer insulating layer→source-drain metal layer→insulating layer→connection line layer→planarization layer→anode→pixel defining layer→spacer layer. The above is merely an example in which a driving circuit is constituted by a top gate transistor. Of course, according to a specific embodiment, the driving circuit can also be fabricated by a bottom gate transistor, which is not limited herein.

**[0036]** Embodiments of the present disclosure provide

an organic electroluminescence display panel, a fabricating method thereof, and a display device. Specifically, in the above organic electroluminescence display panel, the gate driving circuit and the pixel driving circuits are simultaneously disposed in the display area of the base substrate. Further, it is also ensured that the orthographic projection of the gate driving circuit on the base substrate does not overlap with the orthographic projection of the pixel driving circuits on the base substrate, thereby providing sufficient wiring spaces for both of the gate driving circuit and the pixel driving circuits in the display area. Further, a plurality of top emission type of light-emitting units at least partially covering the pixel driving circuits and the gate driving circuit are further provided in the display area of the base substrate. Therefore, the area occupied by each of the top emission type of light-emitting units is increased. Those skilled in the art should readily contemplate that in a conventional display panel, one of the top emission type of light-emitting units overlaps only with one of the pixel driving circuits. However, by contrast, in embodiments of the present disclosure, the gate driving circuit in the display area has an overlapping region with the top emission type of light-emitting units, thereby ensuring that all circuits in the display area are covered by the top emission type of light-emitting units. In this way, it is ensured that there are sufficient wiring spaces for the gate driving circuit and the pixel driving circuits in the display area, thereby eliminating the need to provide the gate driving circuit at the frame, and achieving an ultra-narrow frame or even a frameless design.

**[0037]** In all the descriptions herein, the expression of "orthographic projection of A on a base substrate" refers to a projection of A onto the base substrate in a direction perpendicular to the base substrate, which should be readily appreciated by those skilled in the art.

**[0038]** Apparently, the person skilled in the art may make various alterations and variations to the present disclosure without departing the spirit and scope of the present disclosure. As such, provided that these modifications and variations of the present disclosure pertain to the scope of the claims of the present disclosure and their equivalents, the present disclosure is intended to embrace these alterations and variations.

## Claims

1. An organic electroluminescence display panel, comprising:

a base substrate having a display area;  
 a gate driving circuit and a plurality of pixel driving circuits located in the display area; and  
 a plurality of top emission type of light-emitting units located in the display area, wherein an orthographic projection of the gate driving circuit on the base substrate at least partially overlaps with an orthographic projection of the plu-

rality of top emission type of light-emitting units on the base substrate.

2. The organic electroluminescence display panel according to claim 1, wherein the orthogonal projection of the gate driving circuit on the base substrate does not overlap with an orthogonal projection of the plurality of pixel driving circuits on the base substrate.
3. The organic electroluminescence display panel according to claim 1, wherein the gate driving circuit is located at an edge of the display area.
4. The organic electroluminescence display panel according to claim 1, wherein the gate driving circuit comprises a gate sub-driving circuit located at an edge of the display area.
5. The organic electroluminescence display panel according to claim 1, wherein the gate driving circuit comprises a first gate sub-driving circuit and a second gate sub-driving circuit located respectively at two opposite edges of the display area.
6. The organic electroluminescence display panel according to claim 1, wherein the gate driving circuit is located between two adjacent pixel driving circuits.
7. The organic electroluminescence display panel according to claim 1, wherein each of the top emission type of light-emitting units comprises an anode, a light-emitting layer and a cathode that are sequentially stacked, wherein the anode is connected to a respective pixel driving circuits.
8. The organic electroluminescence display panel according to claim 7, wherein the anode of each of the top emission type of light-emitting units is connected to the respective pixel driving circuits by a connection line.
9. The organic electroluminescence display panel according to claim 8, wherein the connection line is located between a first film layer where the respective top emission type of light-emitting unit is located and a second film layer where the respective pixel driving circuit is located.
10. A display device comprising the organic electroluminescence display panel according to any of claims 1-9.
11. A fabricating method for the organic electrolumines-

cence display panel according to any of claims 1-9, comprising:

fabricating a gate driving circuit and a plurality of pixel driving circuits in a display area of a base substrate, wherein an orthogonal projection of the gate driving circuit on the base substrate does not overlap with an orthogonal projection of the plurality of pixel driving circuits on the base substrate; and

fabricating further a plurality of top emission type of light-emitting units in the display area, wherein the plurality of top emission type of light-emitting units at least partially cover the plurality of pixel driving circuits and the gate driving circuit, and the orthographic projection of the gate driving circuit on the base substrate at least partially overlaps with an orthographic projection of the plurality of top emission type of light-emitting units on the base substrate.

12. The fabricating method according to claim 11, further comprising:

after fabricating the gate driving circuit and the plurality of pixel driving circuits in the display area of the base substrate, and before fabricating further the plurality of top emission type of light-emitting units in the display area, fabricating connection lines, wherein the connection lines are configured to connect respectively an anode of each of the top emission type of light-emitting units to a respective pixel driving circuit.

5

10

15

20

25

30

35

40

45

50

55

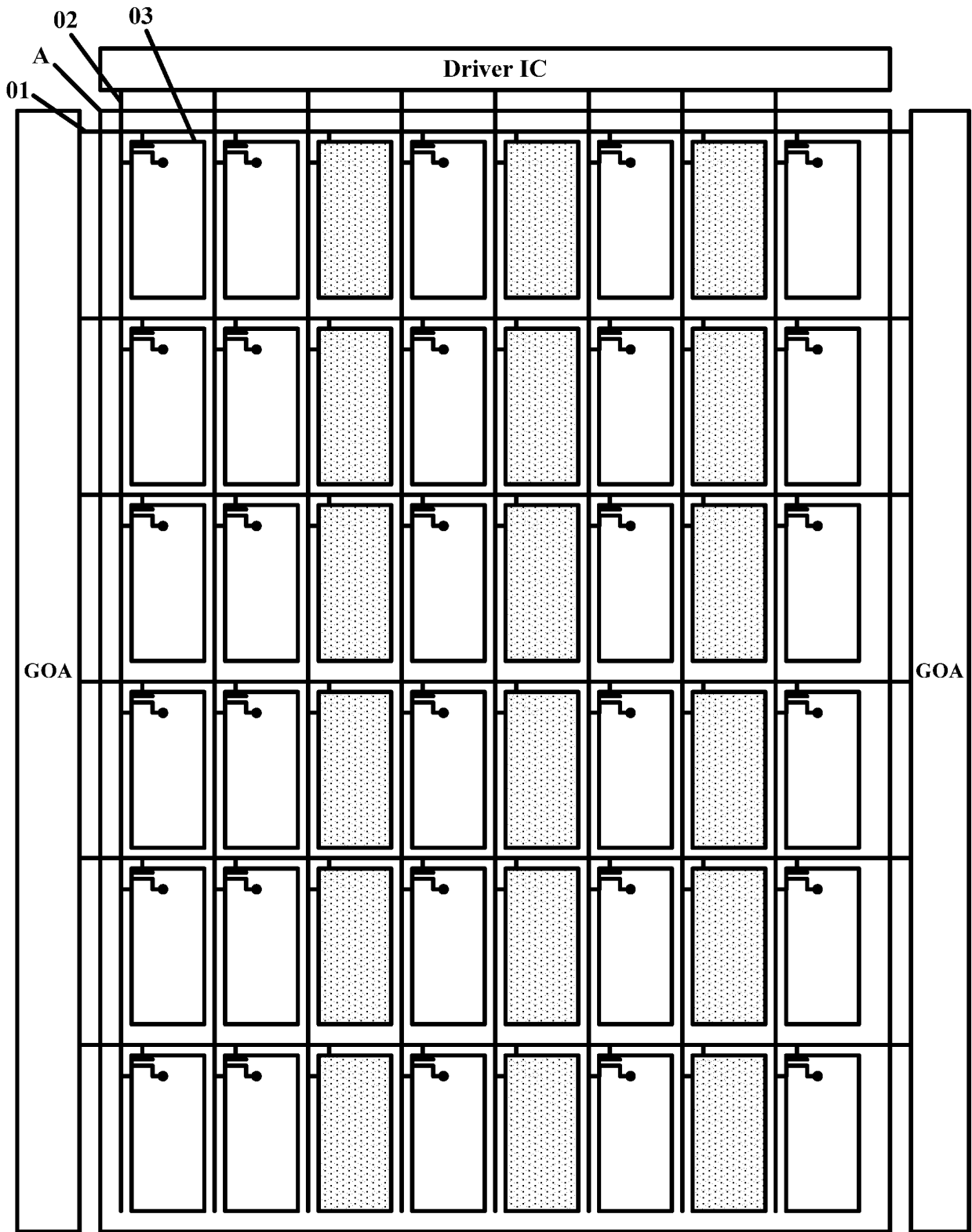

Fig. 1

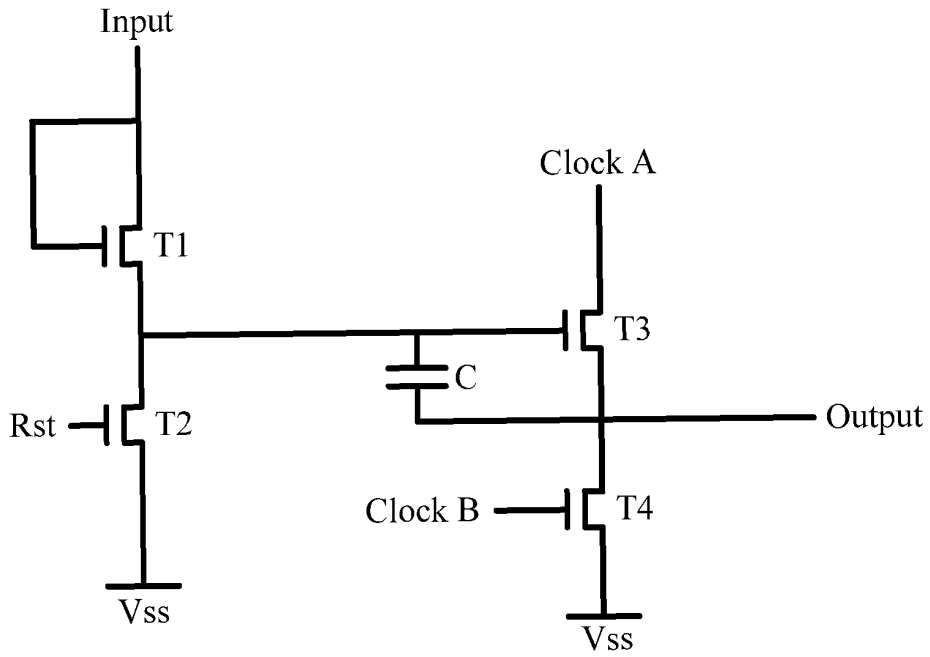

Fig. 2

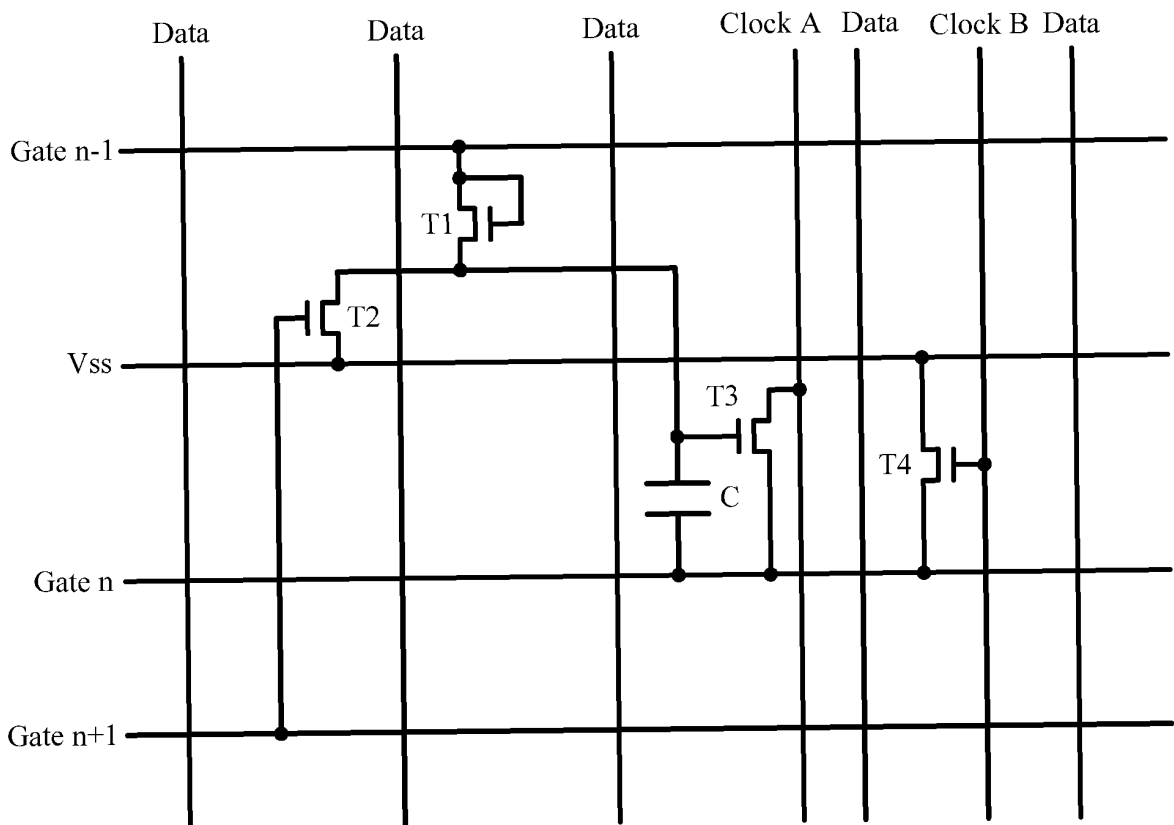

Fig. 3

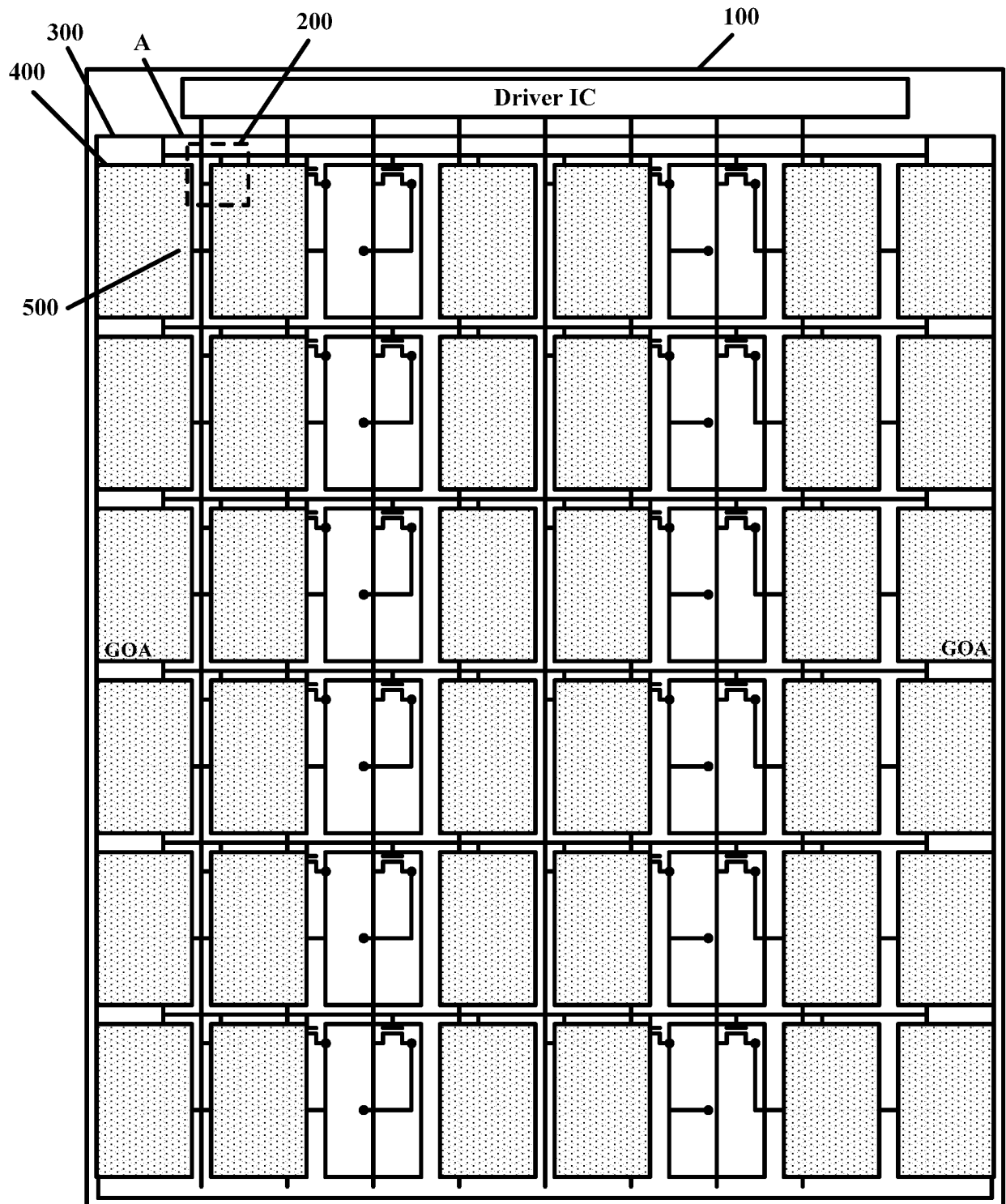

Fig. 4

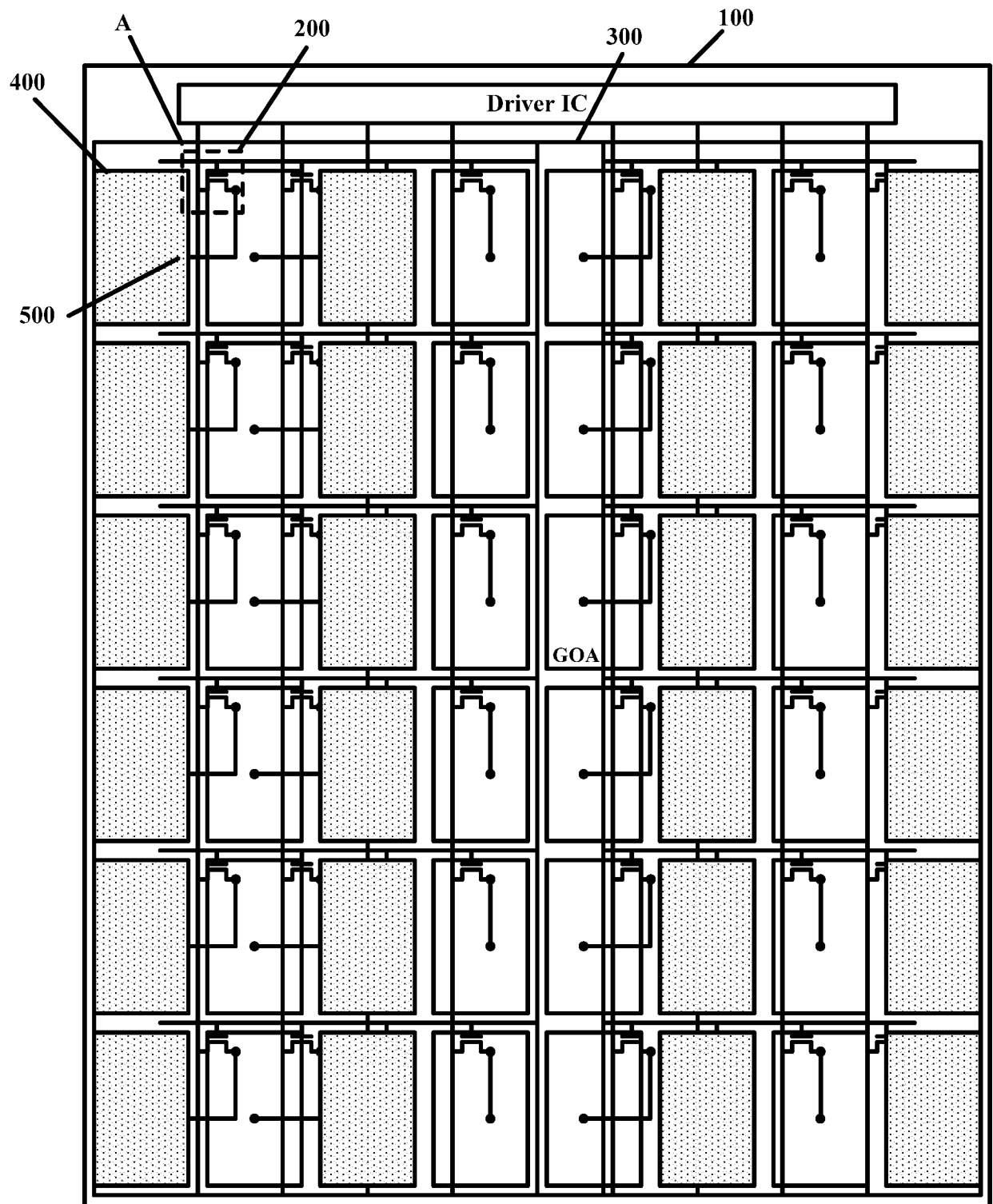

Fig. 5

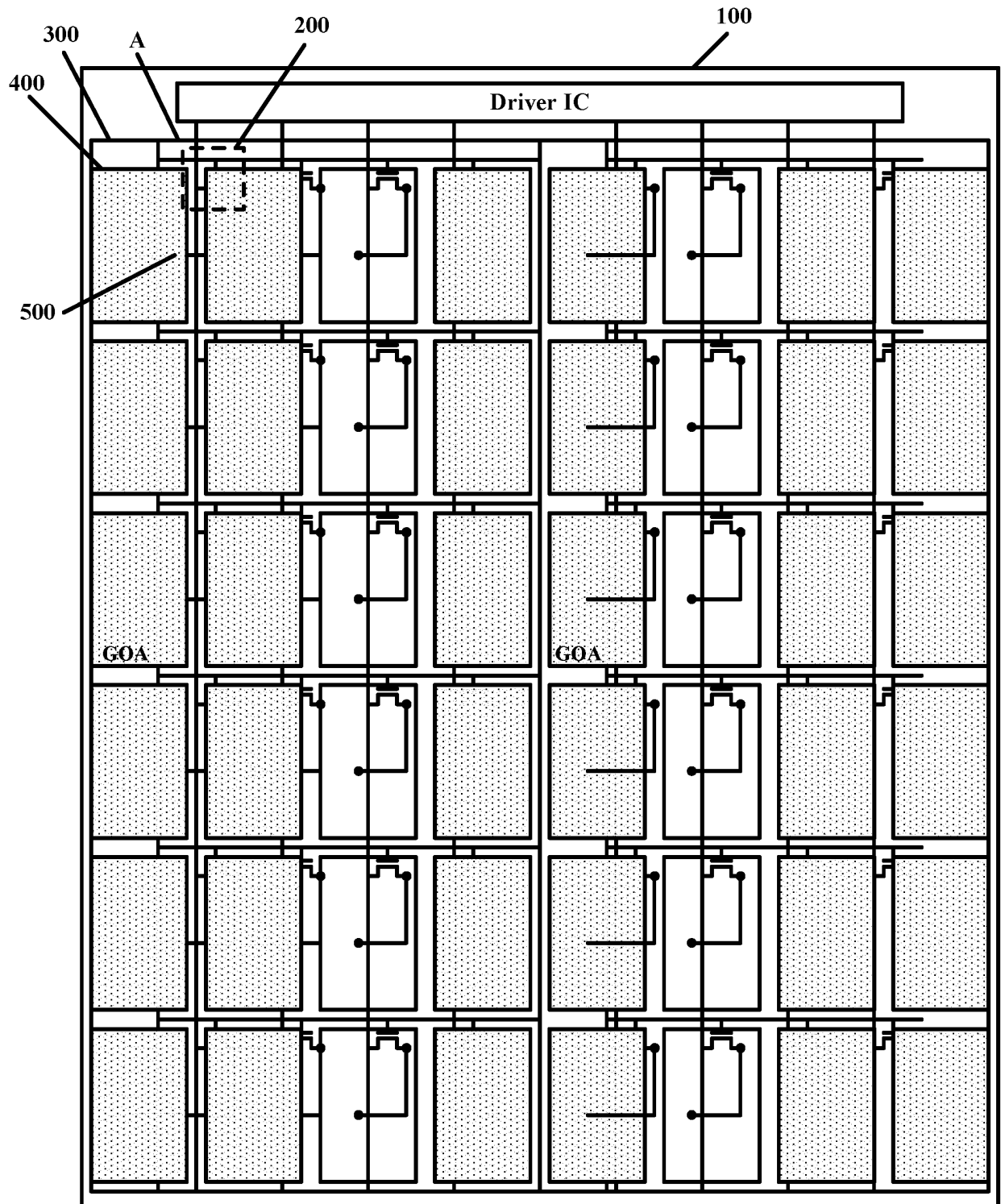

Fig. 6

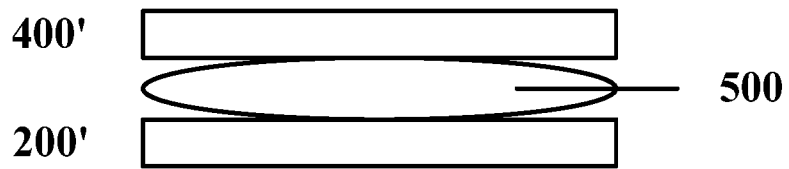

Fig. 7

## INTERNATIONAL SEARCH REPORT

International application No.

PCT/CN2018/087965

<b>A. CLASSIFICATION OF SUBJECT MATTER</b>		
H01L 27/32 (2006.01) i; H01L 27/02 (2006.01) i; H01L 21/77 (2017.01) i According to International Patent Classification (IPC) or to both national classification and IPC		
<b>B. FIELDS SEARCHED</b>		
Minimum documentation searched (classification system followed by classification symbols) H01L; G09G		
Documentation searched other than minimum documentation to the extent that such documents are included in the fields searched		
Electronic data base consulted during the international search (name of data base and, where practicable, search terms used) CNTXT, CNABS, CNKI, DWPI, SIPOABS: 重叠, 驱动电路, 显示区, overlap, drive circuit, display area		
<b>C. DOCUMENTS CONSIDERED TO BE RELEVANT</b>		
Category*	Citation of document, with indication, where appropriate, of the relevant passages	Relevant to claim No.
PX	CN 206947350 U (BOE TECHNOLOGY GROUP CO., LTD. et al.), 30 January 2018 (30.01.2018), description, paragraphs [0024]-[0043], and figures 4-6	1-12
X	CN 106782416 A (SHANGHAI TIANMA MICRO-ELECTRONICS CO., LTD.), 31 May 2017 (31.05.2017), description, paragraphs [0024]-[0040], and figures 1-4	1-12
A	JP 4646951 B2 (SEMICONDUCTOR ENERGY LAB), 09 March 2011 (09.03.2011), entire document	1-12
<input type="checkbox"/> Further documents are listed in the continuation of Box C. <input checked="" type="checkbox"/> See patent family annex.		
* Special categories of cited documents: "A" document defining the general state of the art which is not considered to be of particular relevance "E" earlier application or patent but published on or after the international filing date "L" document which may throw doubts on priority claim(s) or which is cited to establish the publication date of another citation or other special reason (as specified) "O" document referring to an oral disclosure, use, exhibition or other means "P" document published prior to the international filing date but later than the priority date claimed		"T" later document published after the international filing date or priority date and not in conflict with the application but cited to understand the principle or theory underlying the invention "X" document of particular relevance; the claimed invention cannot be considered novel or cannot be considered to involve an inventive step when the document is taken alone "Y" document of particular relevance; the claimed invention cannot be considered to involve an inventive step when the document is combined with one or more other such documents, such combination being obvious to a person skilled in the art "&" document member of the same patent family
Date of the actual completion of the international search 11 July 2018		Date of mailing of the international search report 24 July 2018
Name and mailing address of the ISA State Intellectual Property Office of the P. R. China No. 6, Xitucheng Road, Jimenqiao Haidian District, Beijing 100088, China Facsimile No. (86-10) 62019451		Authorized officer WANG, Xin Telephone No. 86-010-62411567

Form PCT/ISA/210 (second sheet) (January 2015)

**INTERNATIONAL SEARCH REPORT**  
 Information on patent family members

International application No.  
 PCT/CN2018/087965

5

10

15

20

25

30

35

40

45

50

Patent Documents referred in the Report	Publication Date	Patent Family	Publication Date
CN 206947350 U	30 January 2018	None	
CN 106782416 A	31 May 2017	None	
JP 4646951 B2	09 March 2011	JP 2007241314 A	20 September 2007

Form PCT/ISA/210 (patent family annex) (January 2015)

55

**REFERENCES CITED IN THE DESCRIPTION**

*This list of references cited by the applicant is for the reader's convenience only. It does not form part of the European patent document. Even though great care has been taken in compiling the references, errors or omissions cannot be excluded and the EPO disclaims all liability in this regard.*

**Patent documents cited in the description**

- CN 201710516966 [0001]

专利名称(译)	有机电致发光显示板及其制造方法和显示装置		
公开(公告)号	<a href="#">EP3648168A1</a>	公开(公告)日	2020-05-06
申请号	EP2018825345	申请日	2018-05-23
[标]申请(专利权)人(译)	京东方科技集团股份有限公司 成都京东方光电科技有限公司		
申请(专利权)人(译)	京东方科技集团股份有限公司. 成都京东方光电科技有限公司.		
当前申请(专利权)人(译)	京东方科技集团股份有限公司. 成都京东方光电科技有限公司.		
[标]发明人	KO YOUNGYIK TAN WEN HUANG WEIYUN WANG BENLIAN		
发明人	KO, YOUNGYIK TAN, WEN HUANG, WEIYUN WANG, BENLIAN		
IPC分类号	H01L27/32 H01L27/02 H01L21/77		
CPC分类号	H01L27/0207 H01L27/3276 H01L2227/323 H01L21/77 H01L27/02 H01L27/32 G09G3/3225 G09G2310/0264		
优先权	201710516966.4 2017-06-29 CN		
外部链接	<a href="#">Espacenet</a>		

摘要(译)

本发明涉及一种有机电致发光显示面板，其制造方法以及相应的显示装置。有机电致发光显示面板包括：包括显示区域的基底；栅极驱动电路和位于显示区域中的多个像素驱动电路；位于显示区域的顶部发光型的多个发光单元。栅极驱动电路在基础基板上的正投影与在基底基板上的多个顶部发射型发光单元的正投影至少部分重叠。

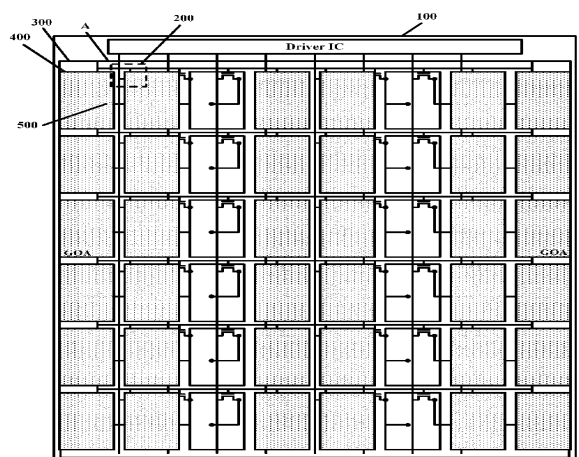

Fig. 4