



US 20160161810A1

(19) **United States**
(12) **Patent Application Publication**
Lim

(10) **Pub. No.: US 2016/0161810 A1**
(43) **Pub. Date: Jun. 9, 2016**

(54) **IN-PLANE SWITCHING MODE LIQUID CRYSTAL DISPLAY DEVICE**

(52) **U.S. Cl.**
CPC **G02F 1/134363** (2013.01); **G02F 1/13439** (2013.01); **G02F 1/133514** (2013.01); **G02F 1/133528** (2013.01)

(71) Applicant: **Hydis Technologies Co., Ltd.**, Icheon-si (KR)

(72) Inventor: **Dong Hoon Lim**, Seoul (KR)

(21) Appl. No.: **15/015,604**

(22) Filed: **Feb. 4, 2016**

Related U.S. Application Data

(62) Division of application No. 14/166,224, filed on Jan. 28, 2014, now Pat. No. 9,285,612, which is a division of application No. 12/270,145, filed on Nov. 13, 2008, now Pat. No. 8,687,154.

Foreign Application Priority Data

Nov. 14, 2007 (KR) 10-2007-0115929
Jul. 29, 2008 (KR) 10-2008-0074196

Publication Classification

(51) **Int. Cl.**
G02F 1/1343 (2006.01)
G02F 1/1335 (2006.01)

(57) **ABSTRACT**

Disclosed is an in-plane switching mode liquid crystal display, in which a pixel electrode and a common electrode are formed on the same substrate. The display includes a first substrate having a first conductive layer and second conductive layer, the first conductive layer and second conductive layer formed on each surface of the first substrate; a second substrate has a transparent pixel electrode and a transparent common electrode formed on one surface of the second substrate, facing the second conductive layer; an electrical connection part is installed to electrically connect the second conductive layer to the transparent common electrode, wherein a common voltage applied to the transparent common electrode is applied to the second conductive layer through the electrical connection part. This arrangement prevents generation of static electricity to suppress a whitening phenomenon due to liquid crystal polarization in a liquid crystal layer, thereby improving display image quality.

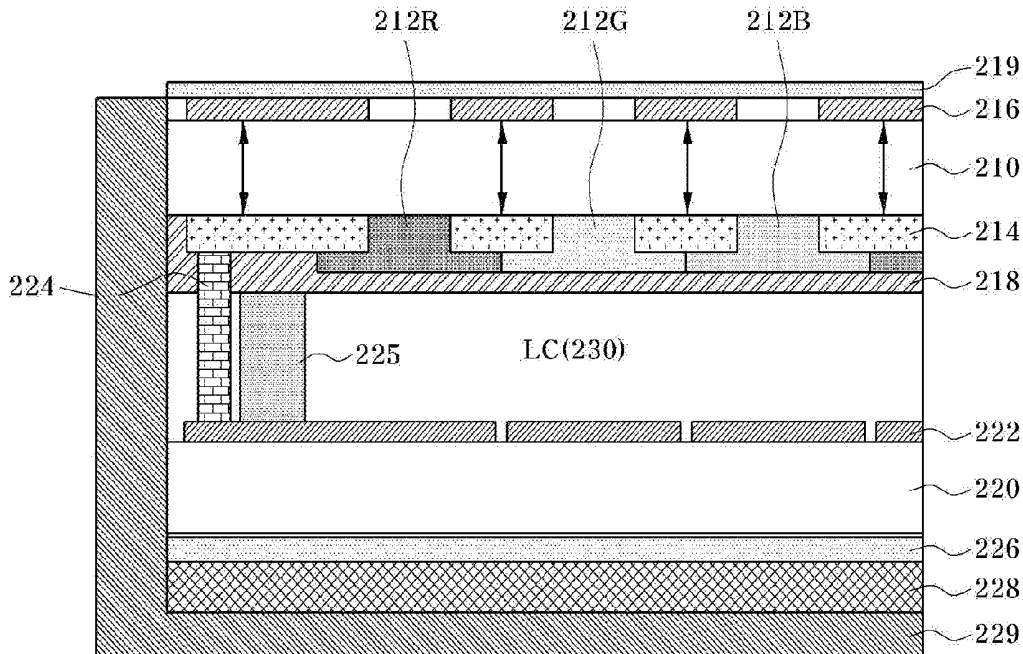
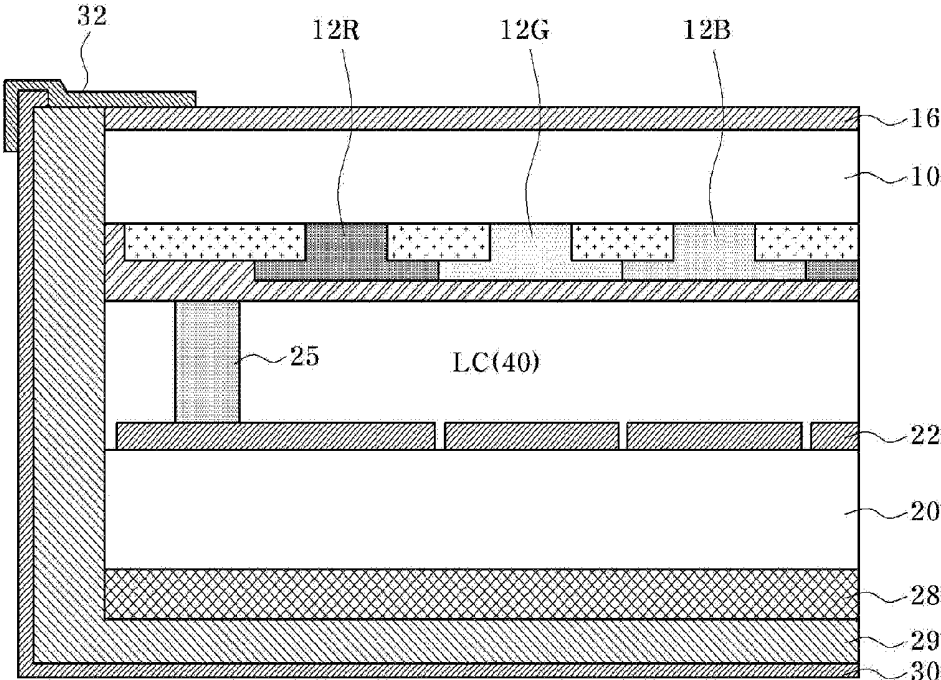

FIG. 1



PRIOR ART

FIG. 2A

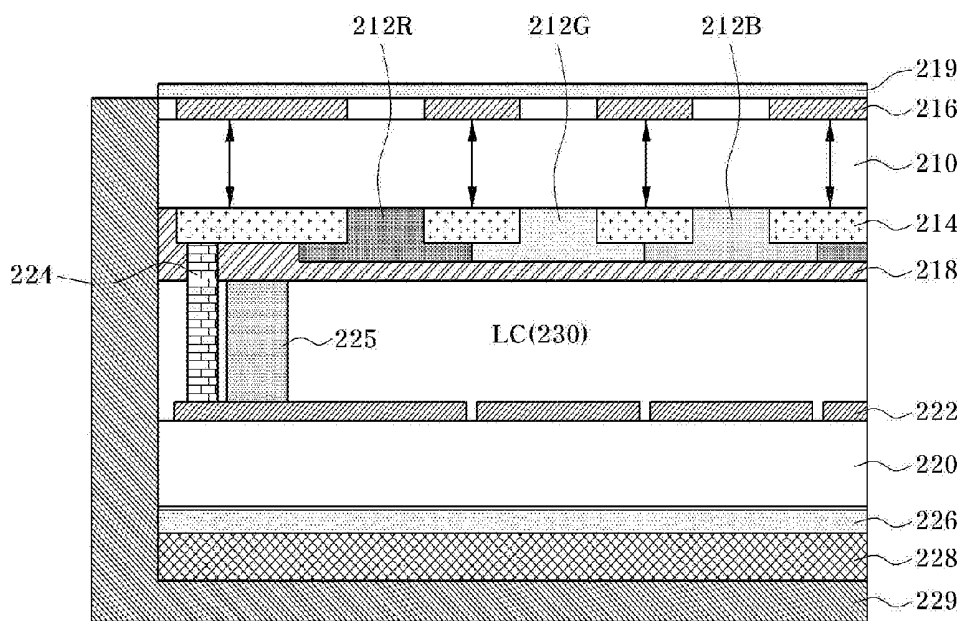

FIG. 2B

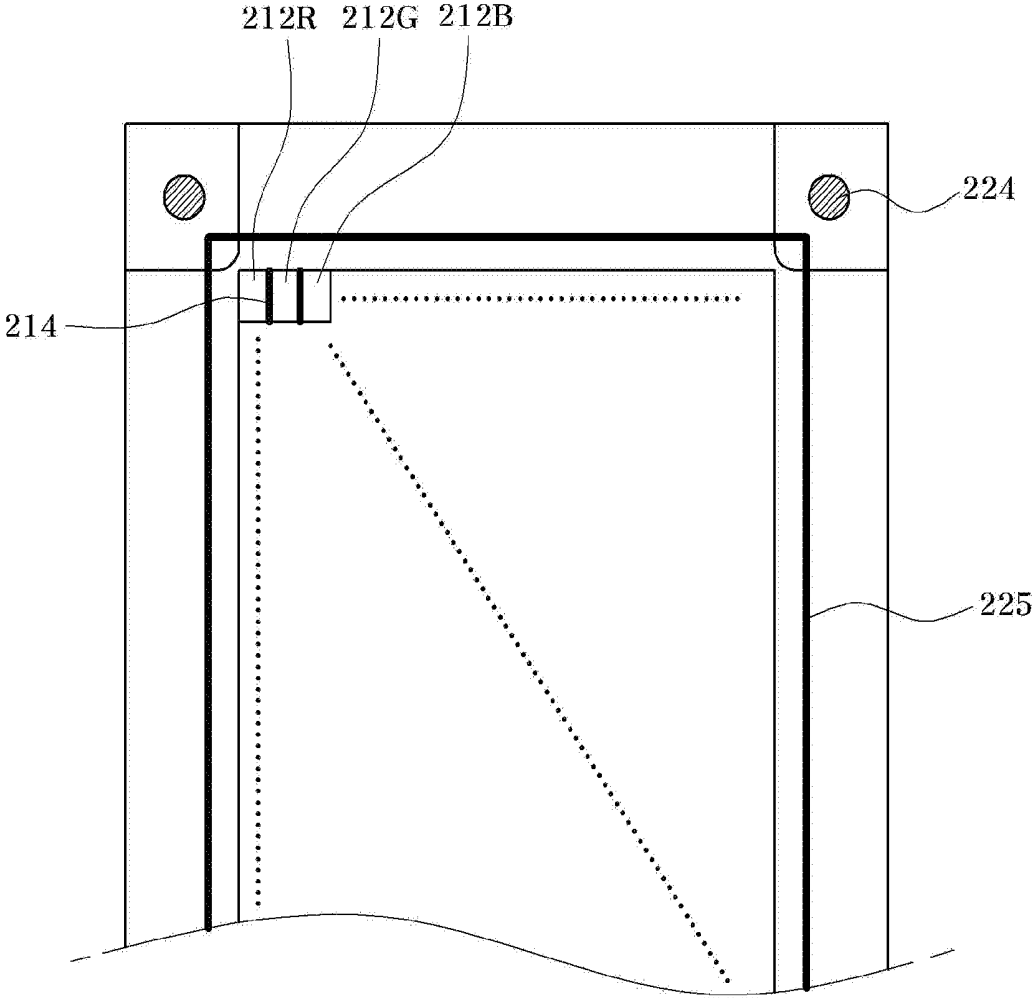

FIG. 3

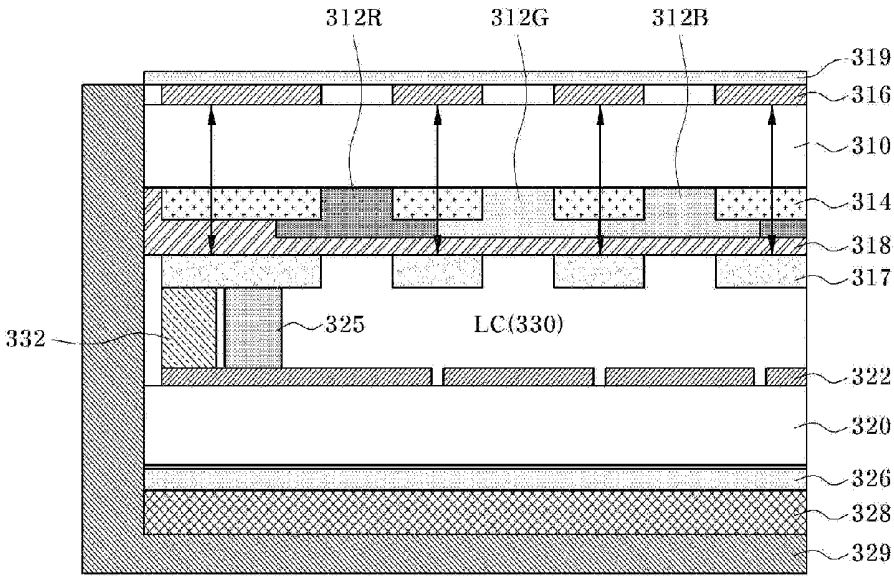

FIG. 4

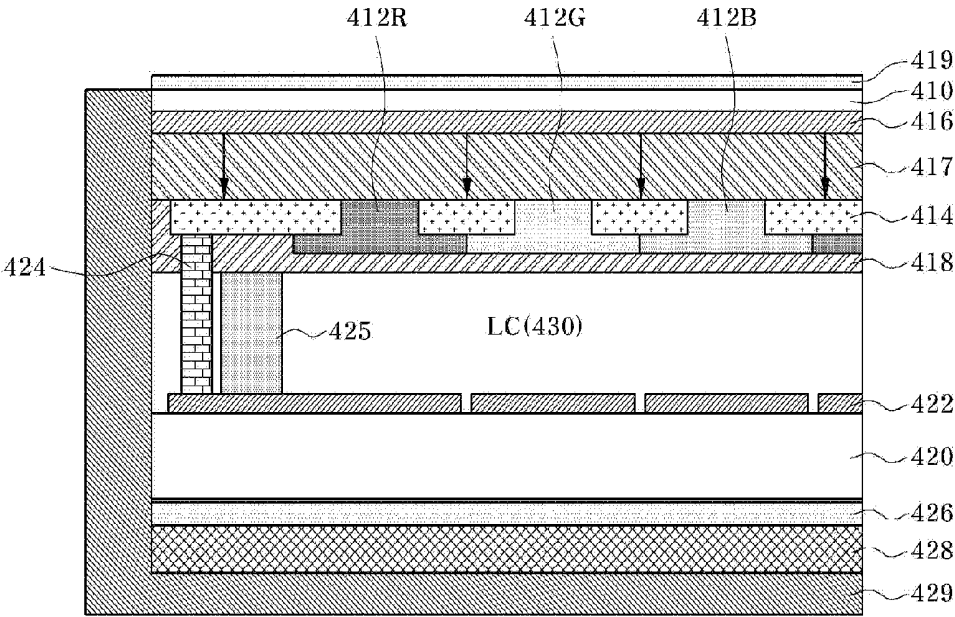
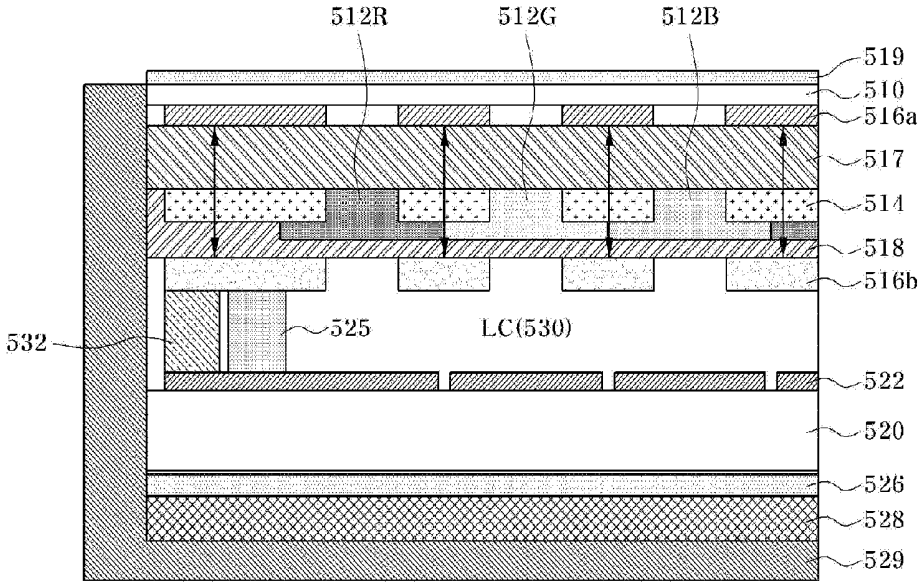

FIG. 5



IN-PLANE SWITCHING MODE LIQUID CRYSTAL DISPLAY DEVICE

CROSS REFERENCE TO RELATED APPLICATIONS

[0001] This application is a divisional of U.S. application Ser. No. 14/166,224, filed Jan. 28, 2014, which is a divisional of U.S. application Ser. No. 12/270,145, filed Nov. 13, 2008, which issued as U.S. Pat. No. 8,687,154 on Apr. 1, 2014, and claims priority to Korean Patent Application No. 10-2008-0074196, filed Jul. 29, 2008, and Korean Patent Application No. 10-2007-0115929, filed Nov. 14, 2007, the disclosures of which are each hereby incorporated in their entirety by reference.

BACKGROUND OF THE INVENTION

[0002] 1. Field of the Invention

[0003] The present invention relates, in general, to an in-plane switching mode liquid crystal display device having a pixel electrode and a common electrode formed on the same substrate, and more particularly, to an in-plane switching mode liquid crystal display device capable of suppressing a liquid crystal polarization due to external static electricity to improve display image quality, by forming an induced electric field between a first conductive layer and a second conductive layer, to which a common voltage is applied through an electrical connection.

[0004] 2. Description of the Related Art

[0005] In recent times, research on an in-plane switching mode (IPS) liquid crystal display (LCD) has been widely performed. The IPS LCD includes two electrodes formed on the same substrate such that a voltage is applied between the two electrodes to generate a horizontal electric field or a fringe electric field with respect to the substrate.

[0006] Hereinafter, the structure of a conventional IPS LCD will be described in brief with reference to the accompanying drawings.

[0007] FIG. 1 is a schematic cross-sectional view of a conventional IPS LCD.

[0008] Since the conventional IPS LCD shown in FIG. 1 includes a pixel array 22 having a pixel electrode and a common electrode and formed at one side of a lower substrate 20, when static electricity is generated from an upper substrate having no electrode, a liquid crystal polarization may be generated in a liquid crystal layer (LC, 40) due to static electricity, thereby deteriorating display image quality. In order to prevent occurrence of the liquid crystal polarization, a method of grounding static electricity introduced from the exterior through an SUS bezel 30 upon introduction of the static electricity by coating a transparent conductive layer 16 on a rear surface of the upper substrate 10, and connecting a copper tape 32 to the SUS bezel 30 surrounding a mold frame 29 has been used.

[0009] As described above, the transparent conductive layer 16 in contact with the SUS bezel 30 functions as a ground terminal to prevent the upper substrate 10 as a dielectric material from being charged upon introduction of external static electricity, thereby preventing intrusion of the electric field into a liquid crystal 40 due to the static electricity.

[0010] However, when the SUS bezel 30 is removed in order to form a small, lightweight and compact device such as a mobile or portable appliance, the transparent conductive

layer 16 formed on the rear surface of the upper substrate 10 must be floated, making it impossible to perfectly shield the static electricity.

SUMMARY OF THE INVENTION

[0011] Accordingly, the present invention has been made keeping in mind the above problems occurring in the related art, and an object of the present invention is to provide an in-plane switching mode liquid crystal display capable of suppressing a liquid crystal polarization due to external static electricity to improve display image quality.

[0012] In order to achieve the above object, according to one aspect of the present invention, there is provided an in-plane switching mode liquid crystal display comprising: a first substrate having a first conductive layer and second conductive layer, the first conductive layer and second conductive layer formed on each surface of the first substrate; a second substrate having a transparent pixel electrode and a transparent common electrode formed on one surface of the second substrate, facing the second conductive layer; an electrical connection part is installed to electrically connect the second conductive layer to the transparent common electrode, wherein a common voltage applied to the transparent common electrode is applied to the second conductive layer through the electrical connection part.

[0013] According to another aspect of the present invention, there is provided an in-plane switching mode liquid crystal display comprising: a first substrate having a first conductive layer, second conductive layer, and an insulating layer between the first conductive layer and second conductive layer; a second substrate having a transparent pixel electrode and a transparent common electrode formed on one surface of the second substrate, facing the second conductive layer; an electrical connection part is installed to electrically connect the second conductive layer to the transparent common electrode, wherein a common voltage applied to the transparent common electrode is applied to the second conductive layer through the electrical connection part.

[0014] The insulating layer may be over coater layer for improving planarization.

[0015] The color filter layer may be formed on the first substrate, including color filter patterns and the second conductive layer may be patterned conductive light-shielding layer formed between the color filter patterns.

[0016] The first conductive layer may be patterned in a shape corresponding to the light-shielding layer.

[0017] The color filter layer may be further formed on the first substrate including color filter patterns and a conductive light-shielding layer formed between the color filter patterns, and wherein the second conductive layer is patterned in a shape corresponding to the conductive light-shielding layer.

[0018] The first conductive layer may be replaced with a conductive polarizer.

[0019] Preferably, the in-plane switching mode liquid crystal display further comprises a conductive polarizer on the first conductive layer.

[0020] The first conductive layer may be formed of a metal material or a conductive resin.

[0021] The first conductive layer may be totally formed of a transparent metal material or a transparent conductive resin.

[0022] Preferably, the in-plane switching mode liquid crystal display further comprises a color filter layer formed on the first substrate, including color filter patterns and a light-shielding layer including color filter patterns.

[0023] Preferably, the in-plane switching mode liquid crystal display further comprises an overcoat layer between the first conductive layer and the second conductive layer.

BRIEF DESCRIPTION OF THE DRAWINGS

[0024] The above and other objects, features and other advantages of the present invention will be more clearly understood from the following detailed description when taken in conjunction with the accompanying drawings, in which:

[0025] FIG. 1 is a schematic cross-sectional view of a conventional in-plane switching mode liquid crystal display;

[0026] FIG. 2A is a schematic cross-sectional view of an in-plane switching mode liquid crystal display in accordance with an exemplary embodiment of the present invention;

[0027] FIG. 2B is a plan view of an in-plane switching mode liquid crystal display including a transfer dotting part of FIG. 2A;

[0028] FIG. 3 is a schematic cross-sectional view of an in-plane switching mode liquid crystal display in accordance with another exemplary embodiment of the present invention;

[0029] FIG. 4 is a schematic cross-sectional view of an in-plane switching mode LCD device according to still another exemplary embodiment of the present invention; and

[0030] FIG. 5 is a schematic cross-sectional view of an in-plane switching mode LCD device according to still another exemplary embodiment of the present invention.

DETAILED DESCRIPTION OF THE INVENTION

[0031] The invention is described more fully hereinafter with reference to the accompanying drawings, in which exemplary embodiments of the invention are shown. This invention may, however, be embodied in many different forms and should not be construed as limited to the exemplary embodiments set forth herein. Rather, these exemplary embodiments are provided so that this disclosure is thorough, and will fully convey the scope of the invention to those skilled in the art.

[0032] FIG. 2A is a schematic cross-sectional view of an in-plane switching mode liquid crystal display in accordance with an exemplary embodiment of the present invention, and FIG. 2B is a plan view of an in-plane switching mode liquid crystal display including a transfer dotting part of FIG. 2A.

[0033] Hereinafter, the in-plane switching mode liquid crystal display in accordance with an exemplary embodiment of the present invention will be described with reference to FIGS. 2A and 2B.

[0034] The in-plane switching mode liquid crystal display in accordance with an exemplary embodiment of the present invention includes a first substrate 210, color filter layers 212R, 212G, and 212B, a conductive light-shielding layer 214, a conductive layer 216, a second substrate 220, a pixel array 222 including a transparent pixel electrode and a transparent common electrode, and an electrical connection part 224.

[0035] The conductive layer 216 is formed on one surface of the first substrate 210. When the conductive layer 216 is formed on the entire one surface of the first substrate 210, the conductive layer 216 may be formed of a transparent conductive resin or a transparent conductive metal material such as indium tin oxide (ITO) or indium zinc oxide (IZO) having relatively good light transmissivity. In addition, when the conductive layer 216 is patterned on one surface of the first

substrate 210 to correspond to the conductive light-shielding layer 214, the conductive layer 216 may be formed of metal material and conductive resin of all types including the transparent conductive resin and the transparent conductive metal material. Here, the transparent conductive resin may be formed of a mixture of indium tin oxide powder and acryl (ITO powder+acryl), epoxy, or the like.

[0036] An upper conductive polarizer 219 may be formed on the conductive layer 216. Otherwise, the upper conductive polarizer 219 may be formed on the first substrate 210 without the conductive layer 216.

[0037] The conductive light-shielding layer, i.e., black matrices 214 function to prevent light leakage, and may include chrome (Cr). The conductive light-shielding layer 214 is formed on the other surface of the first substrate 210 at predetermined intervals to generally divide the color filter layers 212R, 212G and 212B of red, green and blue.

[0038] The color filter layers 212R, 212G and 212B, generally formed of a photosensitive organic material, are alternately arranged in sequence of red, green and blue color filter patterns between the conductive light-shielding layers 214. Meanwhile, an overcoat layer 218 may be selectively formed under the color filter layers 212R, 212G and 212B to remove a step difference generated by the color filter layers 212R, 212G and 212B and improve planarity.

[0039] A pixel array 222 including a transparent pixel electrode and a transparent common electrode is formed on one surface of the second substrate 220. While not specifically shown, each pixel region is defined by gate lines and data lines formed to intersect each other. Switching devices are disposed at the intersection of the gate lines and the data lines. The pixel electrode and the transparent common electrode are spaced apart from each other to overlap a predetermined region, with an insulating layer interposed therebetween, and are disposed in the pixel region in order to apply a voltage to a liquid crystal layer 230 to thereby adjust light transmissivity.

[0040] The electrical connection part 224 is electrically connected to the conductive light-shielding layer 214 and the transparent common electrode of the pixel array 222, and includes a transfer dotting part including a metal having high conductivity, preferably, silver (Ag), or a conductive sealing member including gold (Au).

[0041] When a common voltage is applied to the transparent common electrode of the pixel array 222, the common voltage is applied to the conductive light-shielding layer 214 through the electrical connection part 224 to form an induced electric field between the conductive light-shielding layer 214 and the conductive layer 216, thereby preventing external static electricity from affecting the liquid crystal layer 230. That is, as bi-directional arrows shown in a vertical direction of the first substrate 210 of FIG. 2A, the induced electric field is formed between the conductive layer 216 and the conductive light-shielding layer 214 to prevent occurrence of a liquid crystal polarization in the liquid crystal layer 230.

[0042] In FIG. 2A, reference numeral 225 designates a sealing member, reference numeral 226 designates a lower polarizer, reference numeral 228 designates a back light unit, and reference numeral 229 designates a mold frame.

[0043] When the electrical connection part 224 is a transfer dotting part, as shown in FIG. 2B, the transfer dotting part 224 may be formed outside the sealing member 225 surrounding the pixel region.

[0044] Here, when the conductive layer 216 is replaced with only the upper conductive polarizer 219, the induced electric field is formed between the upper conductive polarizer 219 and the conductive light-shielding layer 214.

[0045] FIG. 3 is a schematic cross-sectional view of an in-plane switching mode liquid crystal display in accordance with another exemplary embodiment of the present invention.

[0046] Referring to FIG. 3, the in-plane switching mode liquid crystal display in accordance with an exemplary embodiment of the present invention includes a first substrate 310, color filter layers 312R, 312G, and 312B, a light-shielding layer 314, a first conductive layer 316, a second conductive layer 317, a second substrate 320, a pixel array 322 including a transparent pixel electrode and a transparent common electrode, and an electrical connection part 332.

[0047] The conductive layer 316 is formed on one surface of the first substrate 310. When the conductive layer 316 is formed on the entire one surface of the first substrate 310, the conductive layer 316 may be formed of a transparent conductive resin or a transparent conductive metal material such as indium tin oxide (ITO) or indium zinc oxide (IZO) having relatively good light transmissivity. In addition, when the conductive layer 316 is patterned on one surface of the first substrate 310 to correspond to the light-shielding layer 314, the conductive layer 216 may be formed of metal material and conductive resin of all types including the transparent conductive resin and the transparent conductive metal material. Here, the transparent conductive resin may be formed of a mixture of indium tin oxide powder and acryl (ITO powder+acryl), epoxy, or the like.

[0048] An upper conductive polarizer 319 may be formed on the first transparent conductive layer 316. On the other hand, the upper conductive polarizer 319 may be formed on the first substrate 310, without the first transparent conductive layer 316.

[0049] The light-shielding layer 314 functions to prevent light leakage, and may include resin. The light-shielding layer 314 formed of resin can implement clear display even in an outdoor environment because the light-shielding layer 314 does not reflect external incident light. In addition, a reddish coloring problem generated by the internal reflection upon implementation of ultra-high brightness can be readily solved, and design of the liquid crystal display and a manufacturing process thereof can be simplified.

[0050] The light-shielding layers 314 are formed on the other surface of the first substrate 310 at predetermined intervals, and generally divide the red, green and blue color filter layers 312R, 312G and 312B.

[0051] The color filter layers 312R, 312G and 312B, generally formed of a photosensitive organic material, are alternately arranged in sequence of red, green and blue color filter patterns between the light-shielding layers 314.

[0052] The second conductive layer 317 substantially patterned under the light-shielding layer 314 in a shape corresponding to the light-shielding layer 314.

[0053] Meanwhile, an overcoat layer 318 may be selectively formed under the color filter layers 312R, 312G and 312B to remove a step difference generated by the color filter layers 312R, 312G and 312B and improve planarity. This case, the second conductive layer 317 may be formed under the overcoat layer 318. Here, the overcoat layer 318 may include a thermosetting material.

[0054] The second conductive layer 317 may be formed between the second substrate 320 and the light-shielding

layer 314. This case, the second conductive layer 317 is patterned in a shape corresponding to the light-shielding layer 314 or on the entire of the second substrate 320.

[0055] The pixel array 322 including a transparent pixel electrode and a transparent common electrode is formed on one surface of the second substrate 320. Meanwhile, each pixel region is defined by gate lines and data lines formed to intersect each other. Switching devices are disposed at the intersection of the gate lines and the data lines (not shown). The pixel electrode and the transparent common electrode are spaced apart from each other to overlap a predetermined region, with an insulating layer (not shown) interposed therebetween, and are disposed in the pixel region in order to apply a voltage to a liquid crystal layer 330 to thereby adjust light transmissivity.

[0056] The electrical connection part 332 is electrically connected to the second conductive layer 317 and the transparent common electrode of the pixel array 322, and includes a transfer dotting part including a metal having high conductivity, preferably, silver (Ag), or a conductive sealing member including gold (Au).

[0057] When a common voltage is applied to the transparent common electrode of the pixel array 322, the common voltage is applied to the second conductive layer 317 through the electrical connection part 332 to form an induced electric field between the second conductive layer 317 and the first conductive layer 316, thereby preventing external static electricity from affecting the liquid crystal layer 330. That is, as shown by arrows, the induced electric field is formed between the first conductive layer 316 and the second conductive layer 317 to prevent occurrence of a liquid crystal polarization in the liquid crystal layer 330.

[0058] Meanwhile, as shown in FIG. 3, the IPS LCD further includes a sealing member 325, a lower polarizer 326, a back light unit 328, and a mold frame 329.

[0059] Here, when the first conductive layer 316 is replaced with the upper conductive polarizer 319, an induced electric field is formed between the upper conductive polarizer 319 and the second conductive layer 317.

[0060] Meanwhile, since basic components of the LCD, which are not specifically described, for example, a thin film transistor, a substrate, a liquid crystal layer, and so on, are the same as in the conventional LCD, detailed descriptions thereof will be omitted.

[0061] FIG. 4 is a schematic cross-sectional view of an in-plane switching mode LCD device according to still another exemplary embodiment of the present invention.

[0062] Referring to FIG. 4, the in-plane switching mode LCD device according to this exemplary embodiment will be described.

[0063] The in-plane switching mode LCD device according to this exemplary embodiment includes a first substrate 410, color filter layers 412R, 412G, and 412B, a conductive light-shielding layer 414, a conductive layer 416, a first overcoat layer 417, a second substrate 420, a pixel array 422 including a transparent pixel electrode and a transparent common electrode, and an electrical connection part 424.

[0064] The conductive layer 416 is formed between the first substrate 410 and a first overcoat layer 417. When the conductive layer 416 is formed on the entire lower surface of the first substrate 410, the conductive layer 416 may be formed of a transparent conductive resin or a transparent conductive metal material such as ITO or IZO having relatively excellent light transmissivity. Further, when the conductive layer 416 is

formed under the first substrate **410** and patterned to correspond to the conductive light-shielding layer **414**, the conductive layer **416** may be formed of metal material and conductive resin of all types including the transparent conductive resin and the transparent conductive metal material.

[0065] The transparent conductive resin may be composed of a mixture (ITO Powder+Acryl) of ITO powder and acryl or epoxy. Further, an upper conductive polarizer **419** may be formed on the first substrate **410**.

[0066] The conductive light-shielding layer **414** serves to prevent light leakage, and may include Cr. The conductive light-shielding layers **414** are formed under the first overcoat layer **417** to be spaced a predetermined distance from each other. In general, the conductive light-shielding layer **414** divide the red, green, and blue color filter layers **412R**, **412G**, and **412B**.

[0067] The filter layers **412R**, **412G**, and **412B**, formed of a photosensitive organic material, are alternately arranged in sequence of red, green, and blue color filter patterns between the respective conductive light-shielding layers **414**. Meanwhile, the second overcoat layers **418** may be selectively formed under the color filter layers **412R**, **412G**, and **412B** so as to remove a step difference formed by the color filter layers **412R**, **412G**, and **412B** and improve planarity.

[0068] The pixel array **422** including a pixel electrode and a transparent common electrode is formed on one surface of the second substrate **420**. Meanwhile, although not shown, the respective pixel regions are defined by gate lines and data lines formed in directions crossing each other, and switching devices are formed at intersections of the gate lines and the data lines. Further, the pixel electrode and the transparent common electrode are spaced apart from each other to overlap a predetermined region, with an insulating layer interposed therebetween, and are formed in the pixel region in order to apply a voltage to a liquid crystal layer **430** to thereby adjust light transmissivity.

[0069] The electrical connection part **424** is electrically connected to the conductive light-shielding layer **414** and the transparent common electrode of the pixel array **422**. The electrical connection part **424** includes a transfer dotting part including a metal having high conductivity, preferably, silver (Ag), or a conductive sealing member including gold (Au).

[0070] When a common voltage is applied to the transparent common electrode of the pixel array **422**, the common voltage is applied to the conductive light-shielding layer **414** through the electrical connection part **424** so as to form an induced electric field between the conductive light-shielding layer **414** and the conductive layer **416**, thereby preventing external static electricity from affecting the LC layer **430**. That is, as indicated by arrows which are represented in the first overcoat layer **417**, the induced electric field is formed between the conductive layer **416** and the conductive light-shielding layer **414**, thereby preventing liquid crystal polarization from occurring in the liquid crystal layer.

[0071] In FIG. 4, reference numerals **425**, **426**, **428**, and **429** represent a sealing member, a lower polarizer, a backlight unit, and a mold frame, respectively.

[0072] FIG. 5 is a schematic cross-sectional view of an in-plane switching mode LCD device according to still another exemplary embodiment of the present invention.

[0073] Referring to FIG. 5, the in-plane switching mode liquid crystal display in accordance with an exemplary embodiment of the present invention includes a first substrate **510**, color filter layers **512R**, **512G**, and **512B**, a light-shield-

ing layer **514**, a first conductive layer **516a**, a second conductive layer **516b**, a second substrate **520**, a pixel array **522** including a transparent pixel electrode and a transparent common electrode, and an electrical connection part **532**.

[0074] The first conductive layer **516a** is formed under the first substrate **510**. When the conductive layer **516a** is formed on the entire one surface of the first substrate **510**, the first conductive layer **516a** may be formed of a transparent conductive resin or a transparent conductive metal material such as ITO or IZO having relatively excellent light transmissivity. Further, when the first conductive layer **516a** is formed under the first substrate **510** and patterned to correspond to the light-shielding layer **514**, the first conductive layer **516a** may be formed of metal material and conductive resin of all types including the transparent conductive resin and the transparent conductive metal material. The transparent conductive resin may be composed of a mixture (ITO Powder+Acryl) of ITO powder and acryl or epoxy. Further, a conductive polarizer **519** may be formed on the first substrate **510**.

[0075] The light-shielding layers **514** are formed under the first conductive layer **516a** to be spaced a predetermined distance from each other. In general, the light-shielding layer **514** divide the red, green, and blue color filter layers **512R**, **512G**, and **512B**.

[0076] The filter layers **512R**, **512G**, and **512B**, formed of a photosensitive organic material, are alternately arranged in sequence of red, green, and blue color filter patterns between the respective light-shielding layers **514**. Meanwhile, the first overcoat layers **517** may be selectively formed between the first conductive layer **516a**, the color filter layers **512R**, **512G**, and **512B** and the light-shielding layer **514**.

[0077] The second conductive layer **516b** substantially patterned under the light-shielding layer **514** in a shape corresponding to the light-shielding layer **514**.

[0078] Meanwhile, an overcoat layer **518** may be selectively formed under the color filter layers **512R**, **512G** and **512B** to remove a step difference generated by the color filter layers **512R**, **512G** and **512B** and improve planarity. The second conductive layer **516b** may be formed under the overcoat layer **518**.

[0079] The second conductive layer **516b** may be formed between the first overcoat layer **517** and the light-shielding layer **514**. The second conductive layer **516b** may be formed on the entire upper one surface of the first overcoat layer **517**.

[0080] The pixel array **522** including a transparent pixel electrode and a transparent common electrode is formed on one surface of the second substrate **520**. Meanwhile, although not shown, the respective pixel regions are defined by gate lines and data lines formed in directions crossing each other, and switching devices are formed at intersections of the gate lines and the data lines. Further, the pixel electrode and the transparent common electrode are spaced apart from each other to overlap a predetermined region, with an insulating layer interposed therebetween, and are formed in the pixel region in order to apply a voltage to a liquid crystal layer **530** to thereby adjust light transmissivity.

[0081] The electrical connection part **532** is electrically connected to the second conductive layer **516b** and the transparent common electrode of the pixel array **522**. The electrical connection part **532** includes a transfer dotting part including a metal having high conductivity, preferably, silver (Ag), or a conductive sealing member including gold (Au).

[0082] When a common voltage is applied to the transparent common electrode of the pixel array **522**, the common

voltage is applied to the second conductive layer **516b** through the electrical connection part **532** so as to form an induced electric field between the first conductive layer **516a** and the second conductive layer **516b**, thereby preventing external static electricity from affecting the LC layer **530**. That is, as indicated by arrows which are represented, the induced electric field is formed between the first conductive layer **516a** and the second conductive layer **516b**, thereby preventing liquid crystal polarization from occurring in the liquid crystal layer.

[0083] Meanwhile, as shown in FIG. 5, the IPS LCD further includes a sealing member **525**, a lower polarizer **526**, a back light unit **528**, and a mold frame **529**.

[0084] In addition, although the exemplary embodiments of the IPS LCD of the present invention have been described, not being limited thereto, the present invention may be adapted to all LCDs using optical anisotropy and polarizing characteristics of liquid crystal.

[0085] As can be seen from the foregoing, a common electric potential is applied to a conductive light-shielding layer formed on the other side of a first substrate through an electrical connection part to form an induced electric field with respect to a conductive layer formed on one side of the first substrate, thereby suppressing a liquid crystal polarization due to external static electricity to improve display image quality.

[0086] Further, according to the present invention, a common potential is applied to a second conductive layer formed on the other surface of the first substrate through an electrical connection part to form an induced electric field with respect to a first conductive layer formed on one side of the first substrate, thereby suppressing a liquid crystal polarization due to external static electricity to improve display image quality.

[0087] Although exemplary embodiments of the present invention have been described for illustrative purposes, not being limited thereto, those skilled in the art will appreciate that various modifications, additions and substitutions are possible, without departing from the scope and spirit of the invention as disclosed in the accompanying claims.

What is claimed is:

1. An in-plane switching mode liquid crystal display comprising:
 - a first substrate having a first conductive layer and second conductive layer, the first conductive layer being formed on one surface of the first substrate and second conductive layer being formed on the other surface of the first substrate;
 - a second substrate having a transparent pixel electrode and a transparent common electrode formed on one surface of the second substrate, facing the second conductive layer;
 - an electrical connection part installed to electrically connect the second conductive layer to the transparent common electrode; and
 - a color filter layer being formed on the first substrate and having color filter patterns and a conductive light-shielding layer formed between the color filter patterns, wherein a common voltage applied to the transparent common electrode is applied to the second conductive layer through the electrical connection part, and the first conductive layer is patterned in a shape corresponding to the conductive light-shielding layer.
2. The in-plane switching mode liquid crystal display according to claim 1, wherein the second conductive layer is patterned in a shape corresponding to the conductive light-shielding layer.
3. The in-plane switching mode liquid crystal display according to claim 1, further comprising a conductive polarizer on the first conductive layer.
4. The in-plane switching mode liquid crystal display according to claim 1, wherein the first conductive layer and the second conductive layer are formed of a metal material or a conductive resin.
5. The in-plane switching mode liquid crystal display according to claim 1, wherein the first conductive layer and the second conductive layer are formed of a transparent metal material or a transparent conductive resin.
6. The in-plane switching mode liquid crystal display according to claim 1, further comprising an overcoat layer between the first conductive layer and the second conductive layer.

* * * * *

专利名称(译)	面内切换模式液晶显示装置		
公开(公告)号	US20160161810A1	公开(公告)日	2016-06-09
申请号	US15/015604	申请日	2016-02-04
[标]申请(专利权)人(译)	HYDIS TECH		
申请(专利权)人(译)	HYDIS TECHNOLOGIES CO. , LTD.		
当前申请(专利权)人(译)	HYDIS TECHNOLOGIES CO. , LTD.		
[标]发明人	LIM DONG HOON		
发明人	LIM, DONG HOON		
IPC分类号	G02F1/1343 G02F1/1335		
CPC分类号	G02F1/134363 G02F1/133528 G02F1/133514 G02F1/13439 G02F1/0136 G02F1/133512 G02F2001/133334 G02F2001/134318		
优先权	1020070115929 2007-11-14 KR 1020080074196 2008-07-29 KR		
外部链接	Espacenet USPTO		

摘要(译)

公开了一种面内切换模式液晶显示器，其中像素电极和公共电极形成在同一基板上。该显示器包括具有第一导电层和第二导电层的第一基板，第一导电层和第二导电层形成在第一基板的每个表面上；第二基板具有透明像素电极和形成在第二基板的一个表面上的透明公共电极，面对第二导电层；安装电连接部分以将第二导电层电连接到透明公共电极，其中施加到透明公共电极的公共电压通过电连接部分施加到第二导电层。这种布置防止产生静电以抑制由于液晶层中的液晶偏振引起的白化现象，从而提高显示图像质量。

