



(19) **United States**

(12) **Patent Application Publication** (10) **Pub. No.: US 2006/0202937 A1**
Chen et al. (43) **Pub. Date: Sep. 14, 2006**

(54) **METHOD AND APPARATUS FOR GENERATING GATE CONTROL SIGNAL OF LIQUID CRYSTAL DISPLAY**

(30) **Foreign Application Priority Data**

Mar. 11, 2005 (TW)..... 94107564

(75) Inventors: **Chien-Ru Chen, Hsinhua (TW); Jung-Zone Chen, Hsinhua (TW)**

Publication Classification

(51) **Int. Cl.**
G09G 3/36 (2006.01)
(52) **U.S. Cl.** **345/100**

Correspondence Address:
MCDERMOTT WILL & EMERY LLP
600 13TH STREET, N.W.
WASHINGTON, DC 20005-3096 (US)

(57) **ABSTRACT**

A liquid crystal display is disclosed, which includes a panel having an array of pixels, a timing controller outputting image data and source control signals, a series of source drivers and a gate driver. One of the source drivers is selected to generate gate control signals by reference to at least one of the source control signals and transmitted to the gate driver. Thus, the gate driver along with the source drivers can drive the panel pixels.

(73) Assignee: **HIMAX TECHNOLOGIES, INC.**

(21) Appl. No.: **11/373,116**

(22) Filed: **Mar. 13, 2006**

200

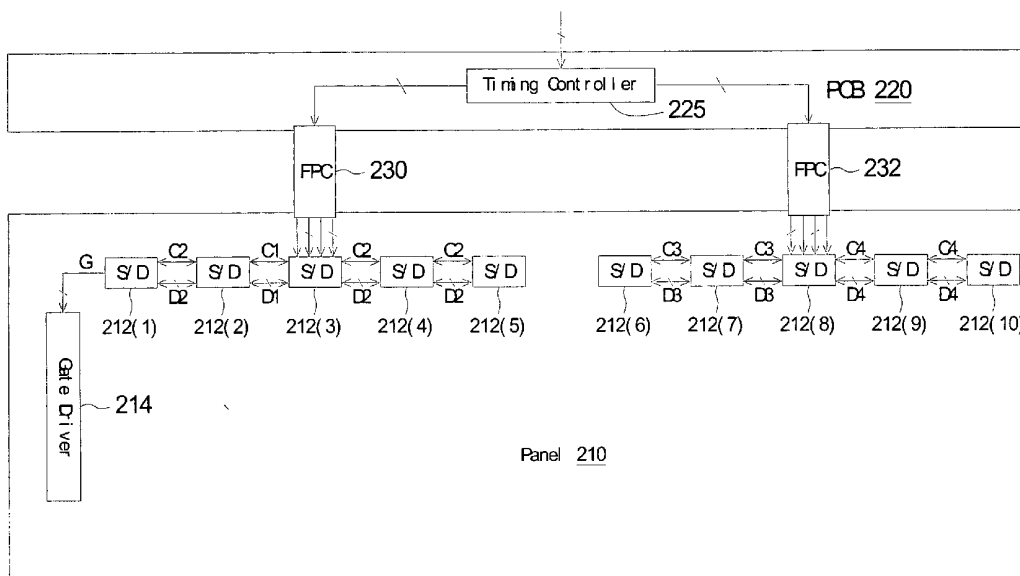

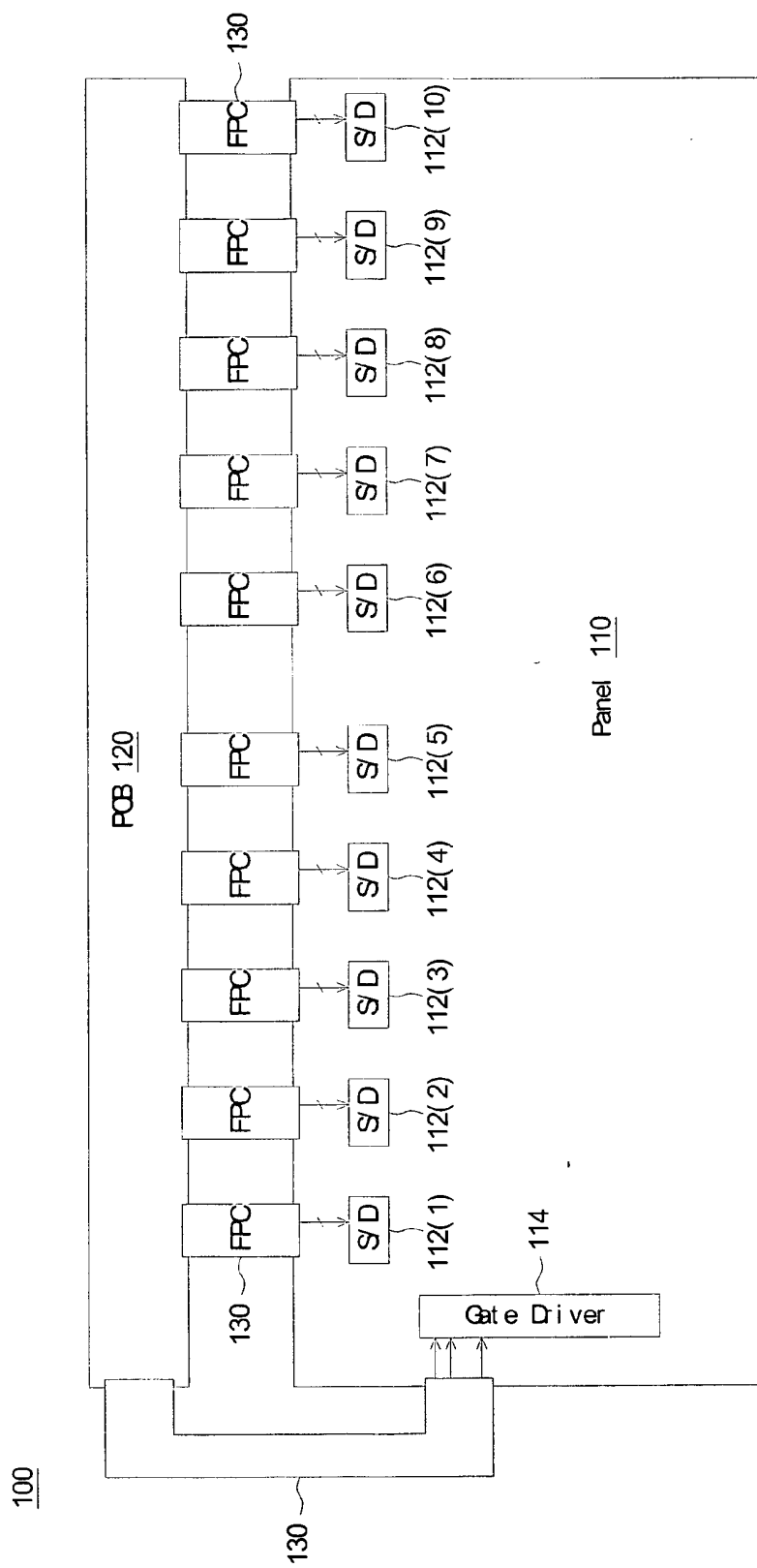

FIG 1(PRIOR ART)

200

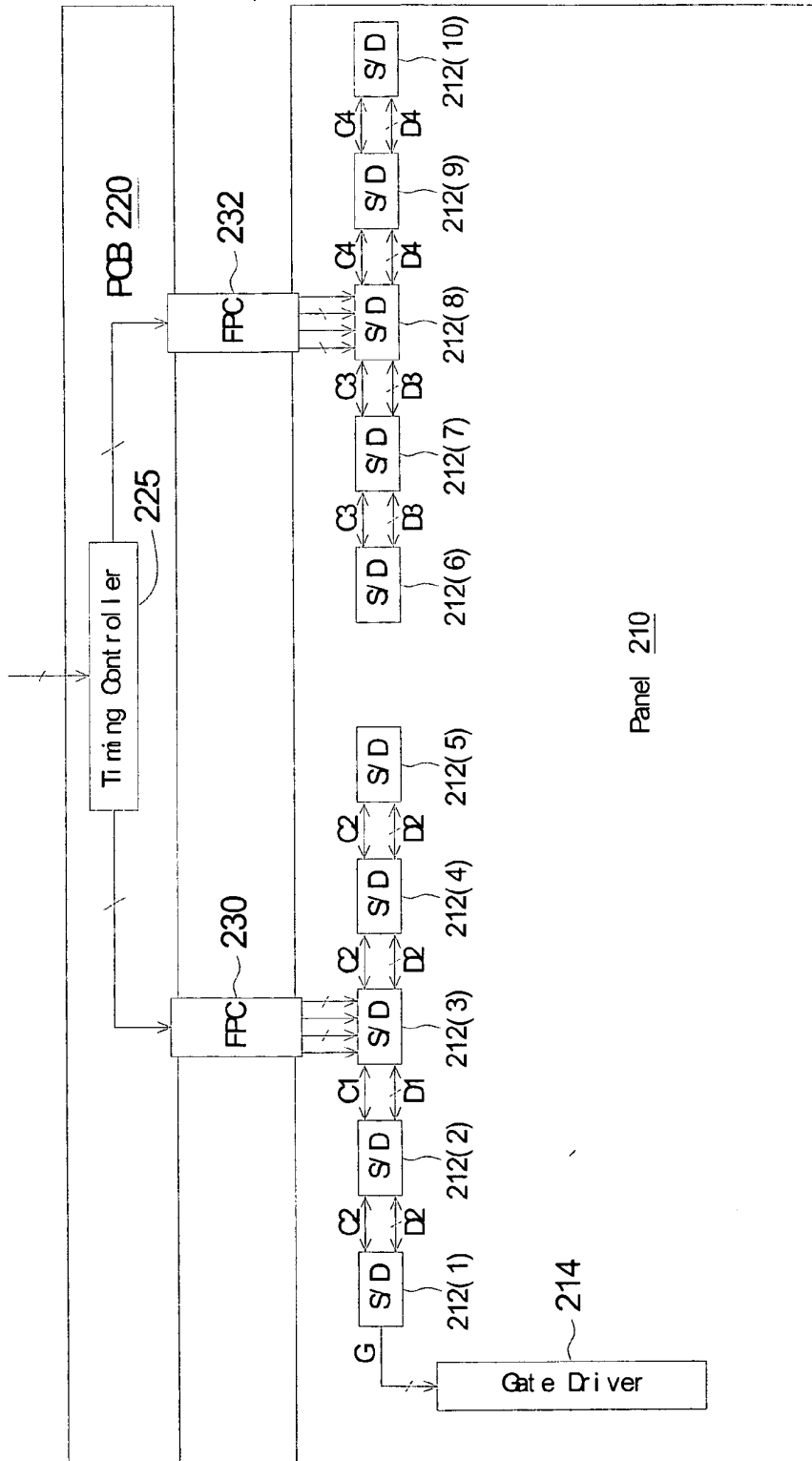
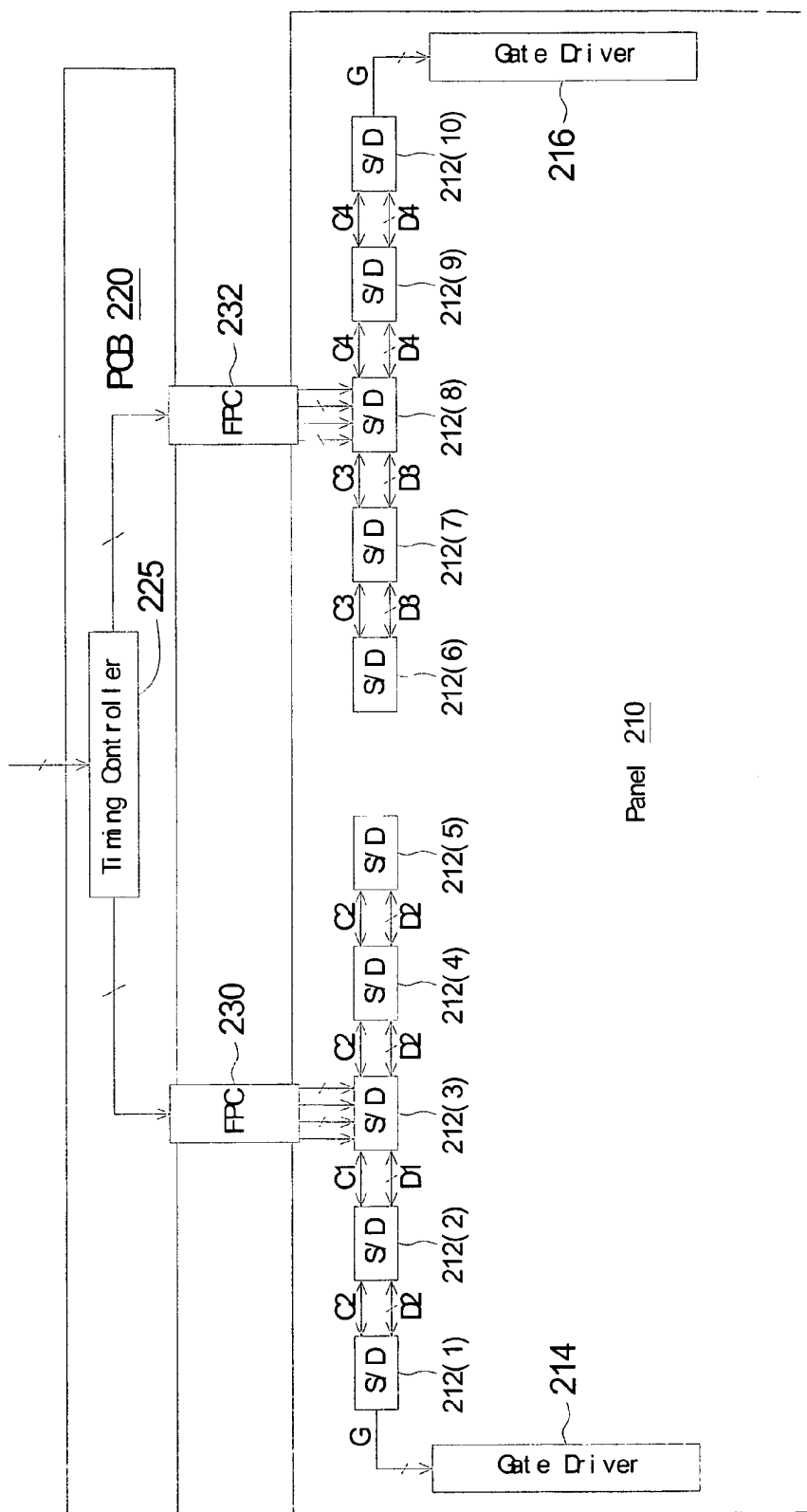

FIG 2A

200



Panel 210

FIG 2B

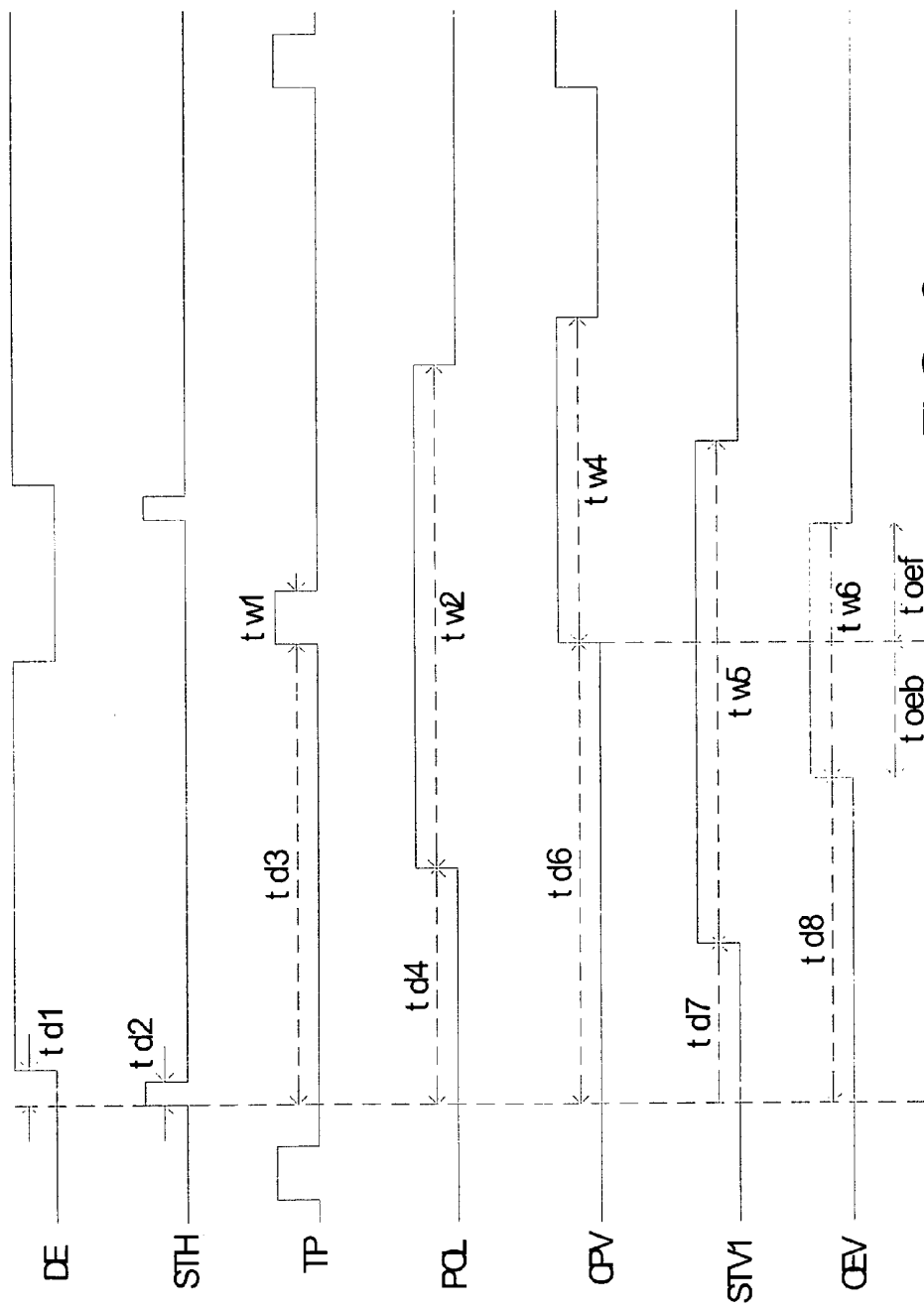

FIG 3

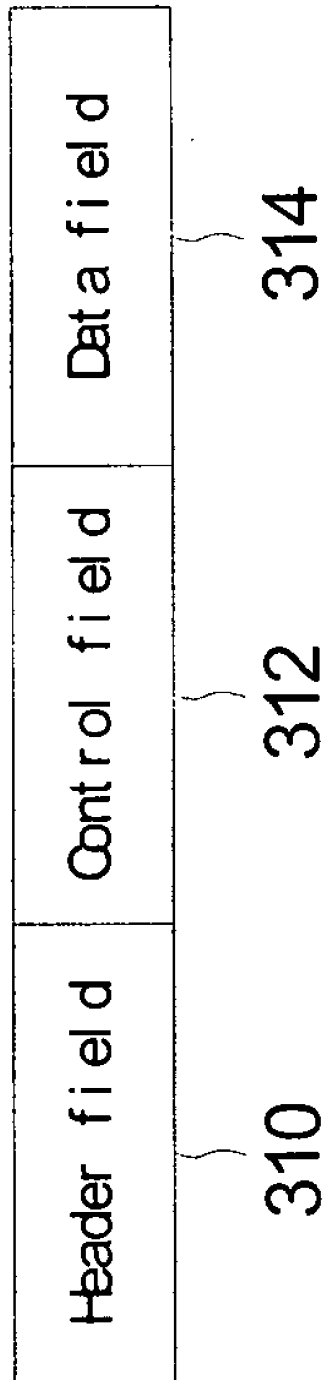

FIG 4

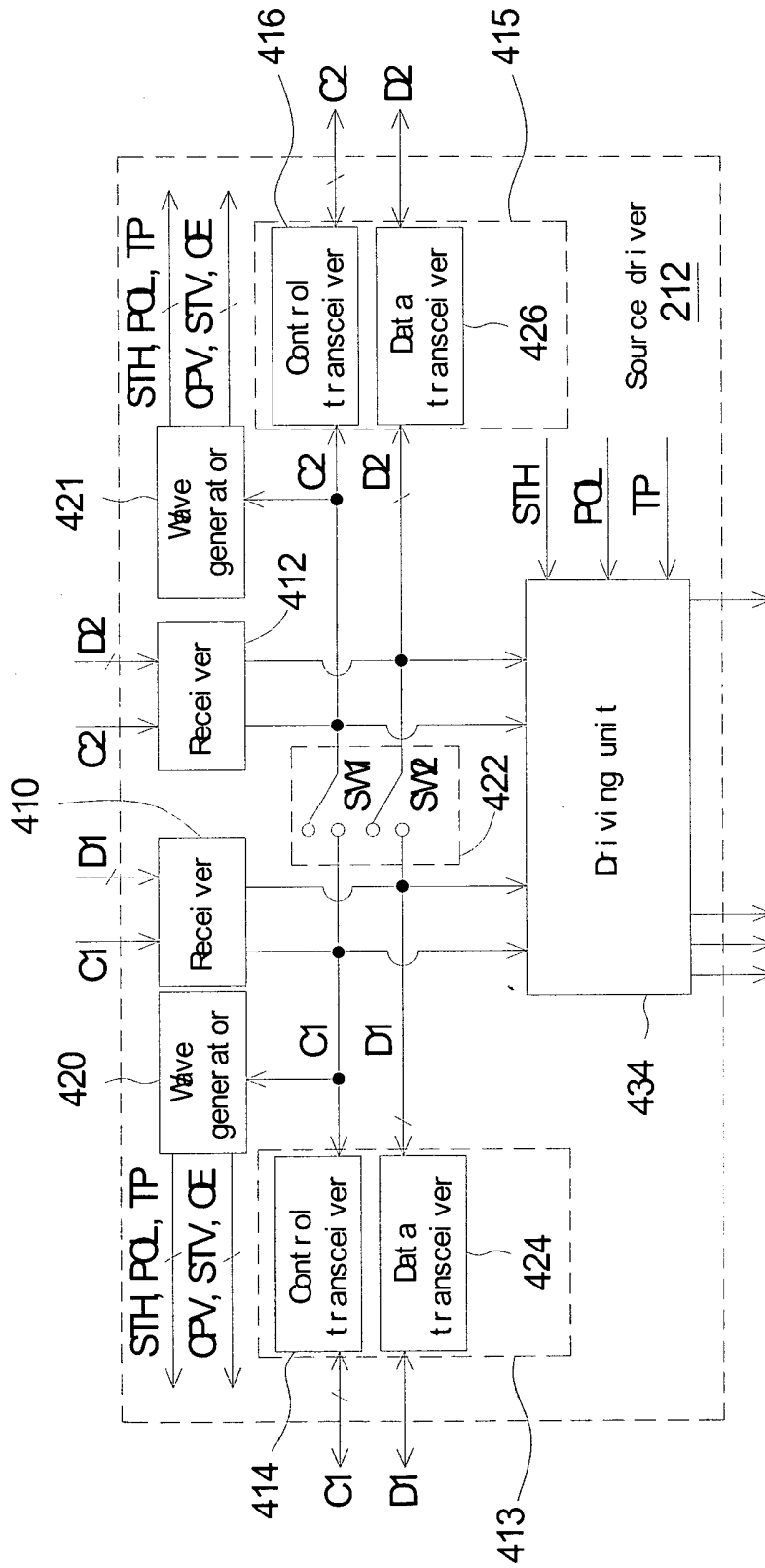

FIG 5A

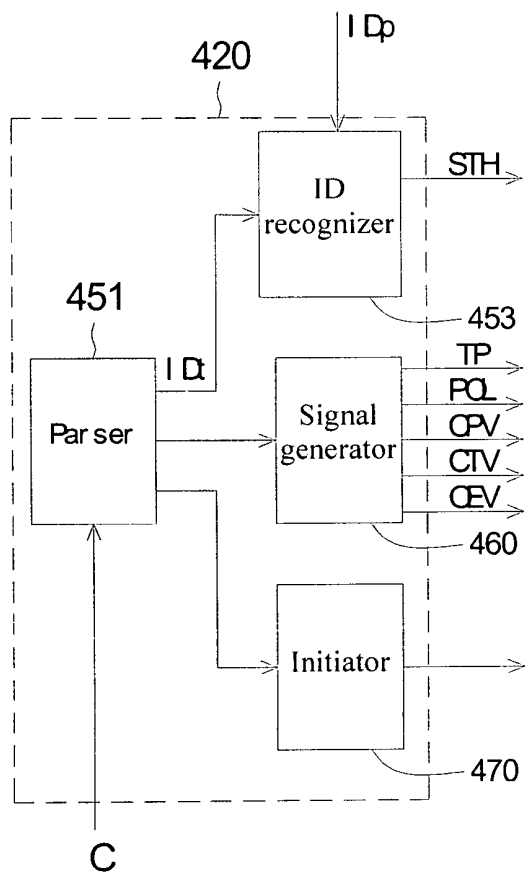

FIG 5B

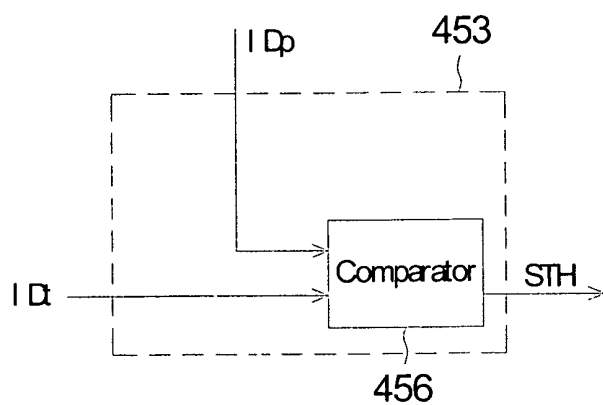

FIG 5C

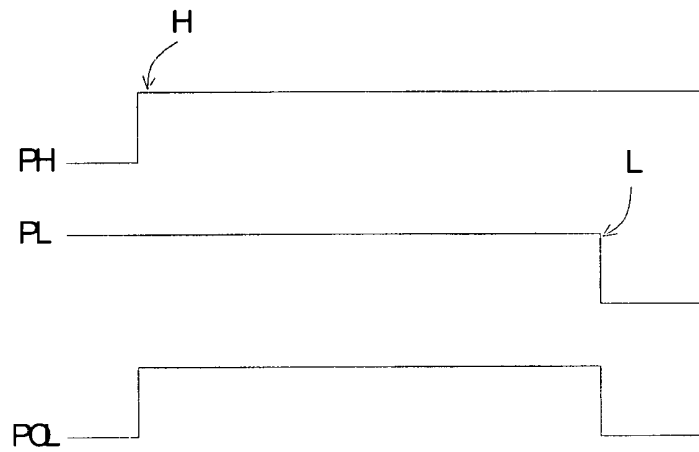

FIG 5D

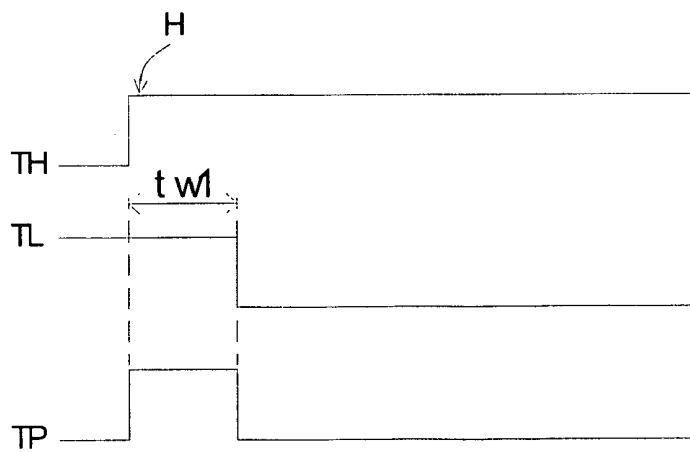

FIG 5E

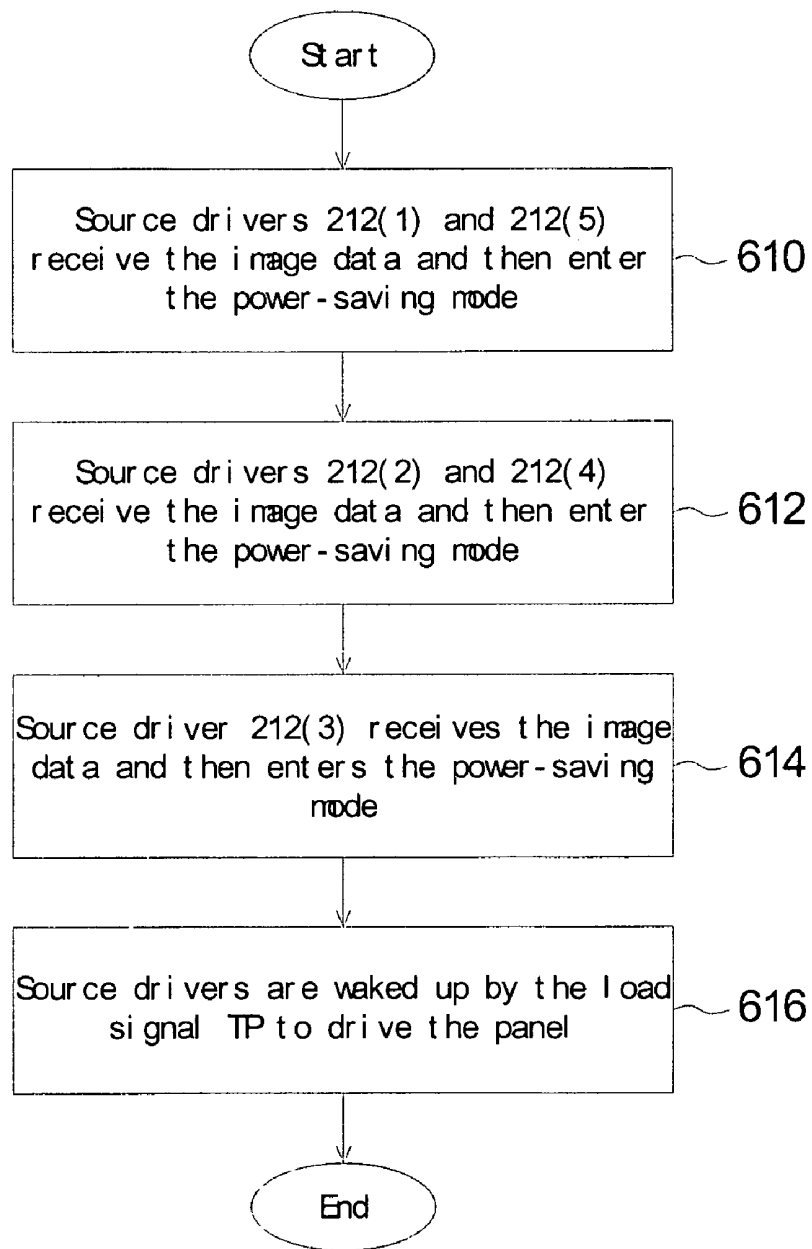

FIG 6A

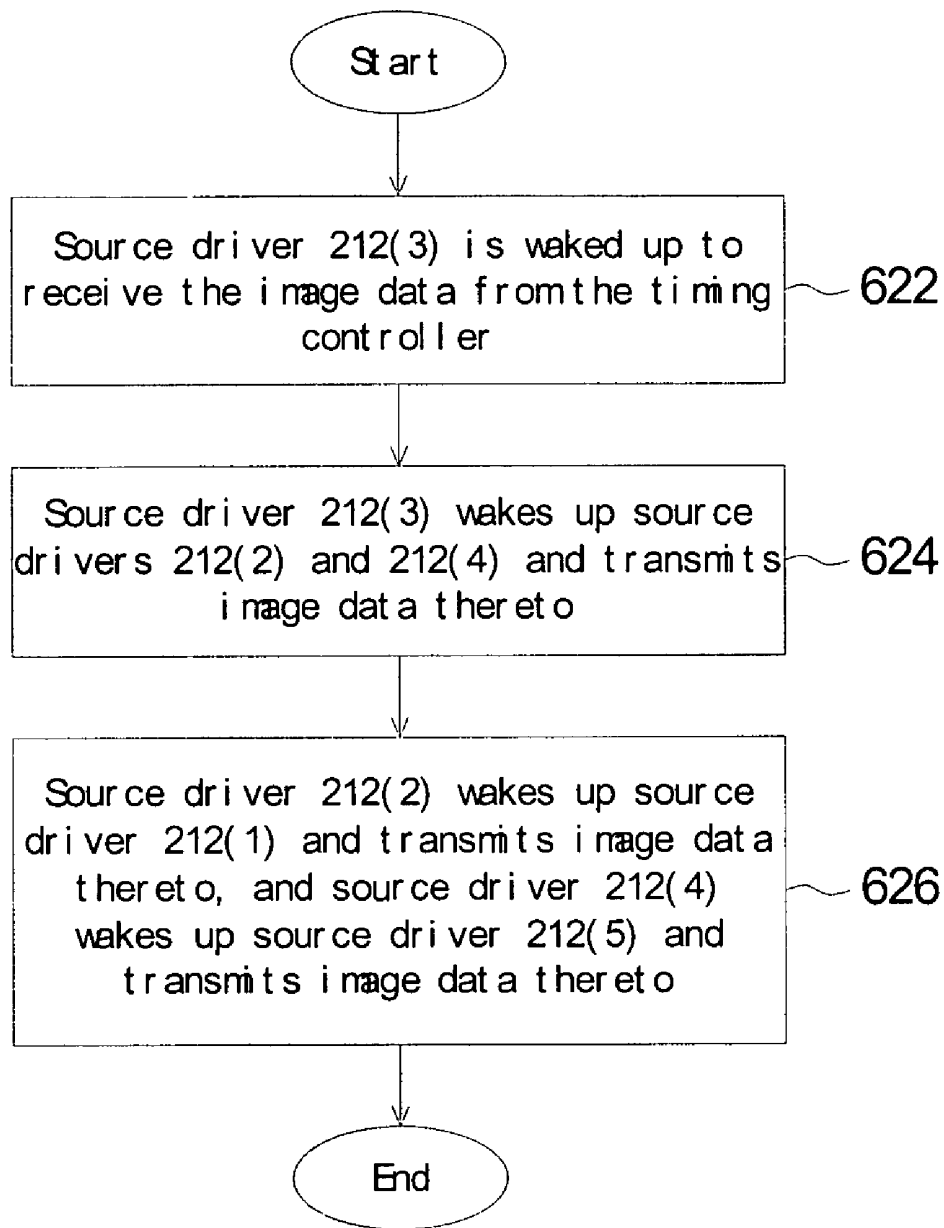

FIG 6B

METHOD AND APPARATUS FOR GENERATING GATE CONTROL SIGNAL OF LIQUID CRYSTAL DISPLAY

[0001] This application claims the benefit of Taiwan application Serial No. 94107564, filed Mar. 11, 2005, the subject matter of which is incorporated herein by reference.

BACKGROUND OF THE INVENTION

[0002] 1. Field of the Invention

[0003] The invention relates in general to a liquid crystal display, and more particularly to a chip-on-glass liquid crystal display.

[0004] 2. Description of the Related Art

[0005] Liquid crystal displays (LCD) have become more and more popular in computer monitors or TVs due to their light weight, flatness and low radiation, compared with the CRT monitor. In addition to improving the display quality of LCDs, such as color, contrast and brightness, the manufacturers try to improve the manufacturing process to reduce the cost and manufacturing time.

[0006] The LCD includes a timing controller, source drivers and at least one gate driver to drive its liquid crystal panel. Conventionally, the timing controller is welded on a control print circuit board, the source drivers are welded on an X-board, and the gate driver is welded on a Y-board. The control print circuit board connects to the X-board via flexible printed circuit boards (FPCs), while the X-board and the Y board each connects to the liquid crystal panel via other FPCs. Therefore, the conventional LCD requires at least three boards to be connected to the panel and the manufacturing process is thus complex. In order to simplify the manufacturing process, the chip-on-glass (COG) LCD has been developed.

[0007] **FIG. 1** is diagram of a conventional COG LCD. The COG LCD **100** includes a panel **110**, a plurality of source drivers **112**, at least one gate driver **114**, a printed circuit board **120** and a plurality of flexible printed circuit boards **130**. The source drivers **112** and the gate driver **114** are disposed on the glass substrate of the panel **110** and electrically connected to the printed circuit board **120** via the flexible printed circuit boards **130**. The timing controller (not shown in **FIG. 1**) is disposed on the printed circuit board **120**, and outputs image data and control signals to the source drivers **112** and the gate driver **114**. In COG LCD **100**, only one board (PCB **120**), instead of three, is required to connect to the panel **110** via the FPCs **130**. Therefore, the manufacturing process is simplified.

[0008] However, the manufacturing process of COG LCD is still not simplified enough because a plurality of flexible printed circuit boards are needed, and in the above example in **FIG. 1**, the number of flexible printed circuit boards is **11**. The flexible printed boards need a plurality of contact points with the liquid crystal panel and the possibility of electrical contact failure is thus increased.

SUMMARY OF THE INVENTION

[0009] It is therefore an object of the invention to provide a COG LCD that reduces the number of flexible printed circuit boards and to provide a transmission method for the LCD.

[0010] It is another object of the invention to provide a method for generating gate control signals for reducing the number of flexible printed circuit boards.

[0011] Furthermore, it is another object of the invention to provide an identifier of the source driver of the COG LCD and an identifying method thereof.

[0012] It is another object of the invention to provide a source driver for single-way or dual-way transmission of the image data and the control signals from the timing controller.

[0013] It is another object of the invention to provide a method for transmitting control signals by packets so as to reduce the number of transmission lines to one or a limited number and reduce the number of flexible printed circuit boards.

[0014] It is another object of the invention to provide a method for power management so as to save power consumption of the COG LCD.

[0015] The invention achieves the above-identified objects by providing a liquid crystal display that comprises a panel, a timing controller, source drivers and at least one gate driver. The panel has pixels arranged in a matrix. The timing controller outputs image data and a source control signal. The source drivers are connected in series and one of the source drivers is selected to generate a gate control signal by reference to the source control signal. The gate driver, along with the source drivers, drives the panel according to the gate control signal.

[0016] The invention achieves the above-identified objects by providing a method for generating a gate control signal of a liquid crystal display. The method first provides image data and a source control signal to the source drivers. Next, one source driver is selected to generate a gate control signal to the gate driver by reference to the source control signal for driving the panel by the gate driver and the source drivers.

[0017] Other objects, features, and advantages of the invention will become apparent from the following detailed description of the preferred but non-limiting embodiments. The following description is made with reference to the accompanying drawings.

BRIEF DESCRIPTION OF THE DRAWINGS

[0018] **FIG. 1** is diagram of a conventional COG LCD.

[0019] **FIG. 2A** is a diagram of a chip-on-glass (COG) liquid crystal display (LCD) according to a preferred embodiment of the invention.

[0020] **FIG. 2B** is a diagram of a COG LCD according to another preferred embodiment of the invention.

[0021] **FIG. 3** is a diagram of control signals of the source drivers and the gate drivers of the LCD.

[0022] **FIG. 4** is a format diagram of a control packet.

[0023] **FIG. 5A** is a diagram of the source driver according to the preferred embodiment of the invention.

[0024] **FIG. 5B** is a block diagram of the wave generator in **FIG. 5A**.

[0025] **FIG. 5C** is a block diagram of the ID recognizer in **FIG. 5B**.

[0026] FIG. 5D is a waveform diagram of control signal POL.

[0027] FIG. 5E is a waveform diagram of the generation of the control signal TP.

[0028] FIG. 6A is a flowchart of a convergent transmission method for power saving.

[0029] FIG. 6B is a flowchart of a divergent transmission method for power saving.

DETAILED DESCRIPTION OF THE INVENTION

[0030] FIG. 2A is a diagram of a chip-on-glass (COG) liquid crystal display (LCD) according to a preferred embodiment of the invention. The LCD 200 includes a panel 210, a plurality of source drivers (S/D) 212(1)-212(10), at least one gate driver 214, a printed circuit board 220 and flexible printed circuit boards (FPC) 230 and 232. The source drivers 212 and gate driver 214 are disposed on the glass substrate of the panel 210 by chip-on-glass technology. The timing controller 225 is disposed on the printed circuit board 220 for outputting image data and control signals both to source drivers 212(3) and 212(8) respectively via the flexible printed circuit boards 230 and 232. Via the wires on the glass substrate, the source driver 212(3) transmits the image data and the control signals to the neighboring source drivers 212(1), 212(2), 212(4) and 212(5), and the source driver 212(8) transmits the image data and the control signals to the neighboring source drivers 212(5), 212(6), 212(7), 212(8) and 212(10). Based on the control signals, one of the source drivers, such as the source driver 212(1), which is nearest to the gate driver 214, can generate gate control signals G to the gate driver 214. The reason to choose the source driver nearest to the gate driver 212 is to reduce the length of the wire therebetween so as to effectively reduce the distortions and delays of the gate control signals G. It is worthy of noting that other source drivers can also be used to generate the gate control signals G, not just limited to the source driver 212(1). In this embodiment, the number of flexible printed circuit boards are greatly reduced to 2 because the LCD uses the wires disposed on the glass substrate for transmitting the image data and the control signals.

[0031] Each of the source drivers 212 has a first operation mode and a second operation mode. The source driver 212(3) and the source driver 212(8) are set to the first operation mode to execute the dual-way transmission. That is, the source driver 212(3) and the source driver 212(8) each receives the image data and control signals from the timing controller 225 and transmits them to the neighboring source drivers at both the right side and the left side thereof. Taking the source driver 212(3) for example, the source driver 212(3) can simultaneously transmit the image data and control signals to both the neighboring source driver 212(2) and 212(4), which are located at the two sides of the source driver 212(3). The source drivers 212(1), 212(2), 212(4)-212(7), 212(9) and 212(10) are set to the second operation mode to execute single-way transmission, and are not directly connected to the timing controller 225. That is, the source drivers 212(1), 212(2), 212(4)-212(7), 212(9) and 212(10) each can receive the image data and the control signals from the right (or left) source driver and transmit them to the left (or right) source driver. Taking the source

driver 212(2) for example, it receives the image data and the control signals from the source driver 212(3) at the right side thereof and transmits them to the source driver 212(1) at the left side thereof. In the embodiment, the LCD 200 is a big screen monitor having 10 source drivers and two flexible printed circuit board 230 and 232. The number of flexible printed circuit boards is not limited to two as long as the distortions and delays of signals are acceptable.

[0032] In the embodiment, the source drivers are divided into a left group including source drivers 212(1)-212(5) and a right group including source drivers 212(6)-212(10). The flexible printed circuit board 230 connects to the center source drivers 212(3) of the left group, and the flexible printed circuit board 232 connects to the center source drivers 212(8) of the right group, such that the distortions and delays of signals, caused by the parasitic capacitance and resistance, can be minimized. On the other hand, the source drivers can also be divided into more than three groups and each group directly connects to the timing controller via a flexible printed circuit board, so long as the distortions and delays of the signals are acceptable.

[0033] FIG. 2B is a diagram of a COG LCD 250 according to another preferred embodiment of the invention. Compared with the LCD 200, the LCD 250 further includes a gate driver 216 at the right side of the panel 210. The gate drivers 214 and 216 together drive the panel 210 from two sides thereof. The other elements of LCD 250 are the same as those as described above.

[0034] FIG. 3 is a diagram of control signals of the source drivers and the gate drivers of the LCD. The control signals include gate control signals G and source control signals S. The gate control signals G include a gate driver start signal STV for representing the start of a frame, a gate clock signal CPV for enabling a gate line, and a gate driver output enable signal OEV for defining the enabled duration of the gate line. The source control signals S include a source driver start signal STH for notifying the source driver to start to prepare the data of a horizontal line, a data enable signal DE for starting to receive data, a load signal TP for starting to output driving voltages to the data lines, and a polarization control signal POL for controlling the polarization inversion.

[0035] When the source driver start signal STH is asserted, the source driver 212 starts to prepare to receive data, and after a period $td1$, the data enable signal DE is asserted such that the timing controller 225 starts to output the image data to the source drivers 212. The source drivers 212 generate the driving voltage with the polarization designated by the polarization control signal POL and then outputs the driving voltages to the panel 210 according to the load signal Tp .

[0036] In the conventional LCD 100, the control signals are outputted by the timing controller directly to each source driver 112 and the gate driver 114. Each control signal conventionally needs at least one wire to transmit, and thus a plurality of wires are required. The control signals are easily distorted and delayed because the wires between the timing controller and the source drivers and the gate driver have parasitic capacitance and resistance.

[0037] In the present embodiment, the timing controller 225 integrates the control signals into a control bitstream C and transmits it by a wire to the source drivers 212. For

example, the control signals can be packed into a plurality of control packets, each representing an event relevant to a control signal. The timing controller 225 can designate one source driver 212 to receive the control packet by a target identification. The target identification is, for example, included in the control packet for each source driver to identify. After receiving the control packet, the source driver 212 can decode the control packet to generate the control signal. Therefore, the number of the wires required to transmit the control signals is thus greatly reduced in the present embodiment.

[0038] The source driver 212 has a built-in identification so as to identify whether a received control packet is for its own by comparing the target identification of the control packet with the built-in identification.

[Transmission Protocol of the Control Bitstream]

[0039] Conventionally, the control signals are each transmitted by a wire from the timing controller to the source driver/gate driver. The source drivers and the gate driver each needs a plurality of control signals and thus the number of the wires for transmitting the control signals is great. Therefore, number of wires in the conventional flexible printed circuit board is also great. The conventional structure thus requires a flexible printed circuit board of high-cost and quality. The lengths of the wires between the timing controller and the source drivers/gate driver are so long as to incur delays and distortions of the signals.

[0040] In the present embodiment, the timing controller 225 transmits the control bitstream C to the source driver a minimum of wires. The control bitstream C includes a plurality of control packets, each representing an event of one corresponding control signal, such as a pull high event or a pull low event. After receiving the control packet, the source driver 212 generates the corresponding control signal by pulling high or pulling low accordingly.

[0041] FIG. 4 is a format diagram of a control packet. A control packet includes a header field 310 and a control item, which includes a control field 312 and a data field 314. The header field 310 records a predetermined pattern for identifying the start of a packet, for example, 0x11111. The control field 312 records the type of the event, such as the STH event, the TP event, the pull high event, the pull low event and the initialization event. The data field 314 records the parameters of the event.

[0042] In the present embodiment, each control packet has 16 bits. If receiving the control packet by dual-edge sampling, it takes 8 clocks to read one control packet. That is, the control signal generated by a pull high event and a pull low event must remain at high level for at least a duration of 8 clocks. The control signals POL, CPV, STV, OEV can each be generated by a pull high event and a pull low event. The control signal that has a duration of less than 8 clocks, such as control signals STH and TP, are generated respectively by the STH event and the TP event. After receiving the STH event/TP event, the source driver pulls high the control signal STH/TP for a pre-determined period $td2/tw1$ and then pulls low the control signal STH/TP. It is worth noticing that the sampling method for receiving the control packet is not limited to dual-edge sampling. Rising-edge sampling or falling-edge sampling can also be used.

[0043] In regard to the control packet having the control field 312 recording the STH event, the data field 314 thereof

records the target identification. For example, the source drivers 212(1)-212(10) have the built-in identifications of 0x0001-0x1010, respectively. After receiving the control packet with STH event, the source driver compares the target identification of this control packet with the built-in identification, pulls high the control signal STH if the comparison is matched, and then pulls low the control signal STH after a period $td2$.

[0044] From FIG. 3, it can be seen that the control signals TP and CPV are pulled high at the same time, so after receiving the control packet with TP event, control signals TP and CPV are pulled high. The control signal TP is then pulled low after a period $tw1$, and the control signal CPV is pulled low after receiving the control packet with pull low event of CPV.

[0045] Control signals POL, STV and OEV are generated by a pull high event and a pull low event. In regard to the control packet with the control field 312 recording a pull high event, its data field 314 designates which signal is to be pulled high. In regard to the control packet with the control field 312 recording a pull low event, its data field 314 designates which signal is to be pulled low.

[0046] In regard to the control packet with the control field 312 recording an initialization event, several kinds of initialization can be set, such as the fan out of the source drivers. Other kinds of events can also be represented by the control packets.

[0047] In the present embodiment, as a minimum of wires is required to transmit the control bitstream C, the number of wires connecting the timing controller and the source drivers are greatly reduced, the layout of the circuit is simplified, and stability is enhanced. In addition, the control bitstream C can integrate only a part of the control signals and leave other parts of the control signals to be transmitted respectively in independent wires. Although not all the control signals are integrated to the control bitstream, the number of wires can still be reduced.

[Source Drivers]

[0048] FIG. 5A is a diagram of the source driver according to the preferred embodiment of the invention. The source driver 212 includes receivers 410, 412, transceivers 413, 415, a bus switch 422, wave generators 420, 421, and a driving unit 434. The transceiver 413 includes a control transceiver 414 and a data transceiver 424, and the transceiver 415 includes a control transceiver 416 and a data transceiver 426.

[0049] The bus switch 422 includes two switches SW1 and SW2. When the source driver, 212(3) or 212(8) in this embodiment, operates at a first operation mode, the bus switch turns off the switches SW1 and SW2 such that the control transceiver 414 and 416 are disconnected from each other and the data transceiver 424 and 426 are disconnected from each other. Thus, the control bitstream C1 and the image data D1 received by the receiver 410 are transmitted to the control transceiver 414 and the data transceiver 424, respectively, and the control bitstream C2 and the image data D2 received by the receiver 410 are transmitted to the control transceiver 416 and the data transceiver 426, respectively.

[0050] When the source driver, 212(1)-212(2), 212(4)-212(7), 212(9), or 212(10) in this embodiment, operates in

a second operation mode, the receivers **410** and **412** are disabled, and the bus switch turns on the switches **SW1** and **SW2** such that the transceivers **413** and **415** are interconnected, that is, the data transceivers **424** and **426** are connected to each other and the control transceivers **414** and **416** are connected to each other. Thus, the source driver can transmit the control bitstream and the image data received to the next adjacent source driver in response to the designated transmission direction.

[0051] The wave generators **420** and **421** receive the control bitstream **C1** and **C2** respectively for generating source control signals **S**, such as **STH(1)**, **STH(2)**, **POL(1)**, **POL(2)**, **TP(1)** and **TP(2)**, etc., and thus generating the gate control signals **G**, such as **CPV(1)**, **CPV(2)**, **STV(1)**, **STV(2)**, **OEV(1)**, **OEV(2)** and etc. The control signals **G** are generated by one of the source drivers. In the LCD **200** in **FIG. 2A**, one of the source drivers **212**, such as **212(1)** that is nearest to the gate driver **214**, generates the gate control signals **G**, while the other source drivers **212** do not. In the LCD **250** in **FIG. 2B**, two source drivers, such as **212(1)** and **212(10)** that are respectively nearest to the gate drivers **214** and **216**, generate the gate control signals **G** respectively for the gate drivers **214** and **216**, while others do not.

[0052] When receiving the signal **STH**, the driving unit **434** starts to latch image data **D** for converting to analog driving voltages in response to the signal **POL**, and then transmits the analog driving signals to the panel **210** after receiving the load signal **TP**.

[0053] In the first-operation-mode source driver, such as **212(3)**, the wave generators **420** and **421** are both activated to receive the control bitstreams **C1** and **C2**, respectively, and generate the source control signals **S** and the gate control signals **G**, while the control bitstream **C1** and **C2** are independent, and image data **D1** and **D2** are independent. On the other hand, in the second-operation-mode source driver, such as **212(2)** or **212(4)**, the control bitstream **C1** is the control bitstream **C2**, and the image data **D1** is the image data **D2**, so only one of the wave generators **420** and **421** is activated to generate the source control signals **S** and the gate control signals **G**. The other wave generator in the second-operation-mode source driver can be disabled, omitted or still activated to generate the source control signals **S** and the gate control signals **G**.

[0054] **FIG. 5B** is a block diagram of the wave generator in **FIG. 5A**. Each of the wave generators **420** and **421** includes a parser **451**, an ID recognizer **453**, a signal generator **460** and an initiator **470**. The parser **451** receives the control bitstream **C** to parse the control item, including the control field **312** and a data field **314**, of a control packet, and sends the parsed control item to the ID recognizer **453**, the signal generator **460** or the initiator **470**. The control item with the identity event, which is the **STH** event in this embodiment, is sent to the ID recognizer **453**; the control item with the pull high event or the pull low event is set to the signal generator **460**; the control item with the initialization event is sent to the initiator **470**.

[0055] **FIG. 5C** is a block diagram of the ID recognizer in **FIG. 5B**. The recognizer **453** includes a comparator **456**. Each source driver has a unique chip identity **IDp**. The chip identity **IDp** is set externally, for example by, respectively, pulling high or pulling low the pins of the source driver on the glass substrate. The comparator **456** triggers the signal

STH when the comparison of the chip identity **IDp** with a target identity **IDt** extracted from the control packet is matched. The duration time **td2** of the signal **STH** can be pre-determined in the comparator **456**.

[0056] The signal generator **460** pulls high the corresponding signal after receiving the control item with the pull high event. The level of the pull-high signal is maintained until the signal generator **460** receives the corresponding control item with the pull low event. Taking generation of the control signal **POL** for example, **FIG. 5D** is a waveform diagram of control signal **POL**. When receiving the control item with the pull high event **H**, the signal generator **460** pulls high the signal **PH**; when receiving the control with the corresponding pull low event **L**, the signal generator **460** pulls low the signal **PL**. The coupling of the signal **PH** and the signal **PL** is the signal **POL**. The other control signals, such as **CPV**, **STV**, **OEV**, are also generated by the above-mentioned procedure.

[0057] The control signal is not suitable to be generated by the pull high event and the pull low event if the duration time of the high level of the control signal is less than 8 clocks, such as the control signal **TP**, since it takes 8 clocks for the wave generator to read a control packet. **FIG. 5E** is a waveform diagram of the generation of the control signal **TP**. When receiving the control item with the pull high event **H** of the control signal **TP**, the signal generator **460** pulls high the signal **TH**, then counts for a pre-determined period **tw1**, and then pulls low the signal **TL**. The coupling of the signal **TH** and the signal **TL** is the control signal **TP**.

[0058] The gate control signals **G** can also be generated according to the source control signals, such as **STH** or **TP**, as shown in **FIG. 3**. The signal **CPV** is generated according to the control signal **STH**. When the control signal **STH** of the source driver **212(1)** is asserted, the counter thereof is activated, and the signal **CPV** is pulled high after a period **td6**, and, after a period **tw4**, the signal **CPV** is pulled low. The signal **STV** is generated according to the control signal **STH**. When the control signal **STH** of the source driver **212(1)** is asserted, the signal **STV** is pulled high after a period **td7** and then pulled low after a period **tw5**. The signal **OEV** is generated according to the control signal **STH**. When the control signal **STH** of the source driver **212(1)** is asserted, the signal **OEV** is pulled high after a period **td8** passed and pulled low after a period **tw6** passed.

[0059] After receiving the control item with the initialization event, the initiator **470** outputs a DC value to set the corresponding parameter.

[0060] The source driver of the present embodiment can reduce the control signal decay because the source control signals are generated by the source driver itself, not by the timing controller in the conventional manner.

[0061] In addition, the present embodiment can reduce the number of wires from the timing controller to the gate driver because the source driver can generate the gate control signals and directly send them to the gate driver via the wires on the glass substrate. The quality of the gate control signals are thus improved because the lengths of the transmission wires are reduced.

[Power Management]

[0062] **FIG. 6A** is a flowchart of a convergent transmission method for power saving. The source drivers **212(1)**-

212(5) in **FIG. 2A** are taken as an example. First, at step **610**, the source drivers **212(1)** and **212(5)**, which have the farthest distances away from the timing controller **225**, receive the image data transmitted by the timing controller **225** via the source drivers. The power-saving mode is entered, which turns off the power for the data transceivers **424** and **426** of the source drivers **212(1)** and **212(5)**, for example. Next, at step **612**, the source drivers **212(2)** and **212(4)**, which are the active ones having the farthest distances away from the timing controller **225**, receive the image data and then enter the power-saving mode, which turns off the power for the data transceivers **424** and **426** of the source drivers **212(2)** and **212(4)**, for example. Next, at step **614**, the source driver **212(3)** receives the image data from the timing controller **225** and then enters the power-saving mode. It is noted that, in the power-saving mode, the power for the control transceiver **416** and **414** of the source driver should not be turned off. Then, at step **616**, each of the source drivers **212(1)-212(5)** receives the load signal TP and then is activated to start to drive the panel **210**. The transmission method can also apply to the source drivers **212(6)-212(10)**.

[**0063**] **FIG. 6B** is a flowchart of a divergent transmission method for power saving. The source drivers **212(1)-212(5)** in **FIG. 2A** are taken as an example. First, the source drivers **212(1)-212(5)** enter the power-saving mode. Next, at step **622**, the source driver **212(3)**, which is nearest to the timing controller **225**, is activated to receive the image data transmitted by the timing controller **225**. Next, at step **624**, the source drivers **212(2)** and **212(4)** are activated to receive the image data. Next, at step **626**, the source drivers **212(1)** and **212(5)** are activated to receive the image data. The transmission method can also apply to the source drivers **212(6)-212(10)**.

[**0064**] In the power-saving mode, at least the power for data transceivers and the driving unit can be turned off. The data transceivers transmit the image data, which have large voltage swings and high frequency that make the power consumption great. Thus the power-saving convergent/divergent transmission methods can reduce unnecessary data transmission for saving power. The power for the control transceivers of the source driver should not be turned off, so that the source driver can still receive the control bitstream and operate responsively.

[**0065**] The convergent transmission method and the divergent transmission method can be applied at the same time. For example, the source drivers **212(1)-212(3)** can use the convergent transmission method, while the source drivers **212(4)-212(5)** use the divergent transmission method, or vice versa

[**0066**] While the invention has been described by way of example and in terms of a preferred embodiment, it is to be understood that the invention is not limited thereto. On the contrary, it is intended to cover various modifications and similar arrangements and procedures, and the scope of the appended claims therefore should be accorded the broadest interpretation so as to encompass all such modifications and similar arrangements and procedures.

What is claimed is:

1. A liquid crystal display comprising:
 - a panel having an array of pixels;
 - a timing controller for outputting image data and a source control signal;
 - a plurality of source drivers connected in series, one of the source drivers configured to generate a gate control signal in response to the source control signal; and
 - at least one gate driver for driving the panel pixels according to the gate control signal.
2. The LCD according to claim 1, wherein the source drivers and the gate driver are disposed on a glass substrate of the panel.
3. The LCD according to claim 1, wherein the source control signal is a source driver start signal (STH) or a load signal (TP).
4. The LCD according to claim 1, wherein the gate control signal comprises a gate clock signal (CPV), a gate driver start signal (STV) and a output enable signal (OEV).
5. The LCD according to claim 2, wherein the one source driver is the source driver nearest on the substrate to the gate driver.
6. A method for generating a gate control signal of a liquid crystal display having a panel, source drivers connected in series and at least one gate driver, the method comprising the steps of:
 - providing image data and a source control signal to the source drivers;
 - selecting one of the source drivers;
 - generating at the selected source driver a gate control signal;
 - applying the gate signal to the gate driver in response to receipt of the source control signal;
 wherein the panel is driven by the gate driver and the source drivers.
7. The method according to claim 6, wherein step for generating the gate control signal comprises:
 - setting a predetermined value;
 - upon receiving the source control signal, starting a count and asserting the gate control signal;
 - maintaining assertion of the gate control signal until the count attains the predetermined value; and
 - de-asserting the gate control signal after the count has attained the predetermined value.
8. The method according to claim 6, wherein the source control signal is a source driver start signal (STH) or a load signal (TP).
9. The method according to claim 6, wherein the gate control signal comprises a gate clock signal (CPV), a gate driver start signal (STV) and a output enable signal (OEV).
10. The method according claim 6, wherein the selected source driver is nearest to the gate driver on the panel.

* * * * *

专利名称(译)	用于产生液晶显示器的栅极控制信号的方法和装置		
公开(公告)号	US20060202937A1	公开(公告)日	2006-09-14
申请号	US11/373116	申请日	2006-03-13
[标]申请(专利权)人(译)	奇景光电股份有限公司		
申请(专利权)人(译)	奇景光电, INC.		
当前申请(专利权)人(译)	HIMAX TECHNOLOGIES LIMITED		
[标]发明人	CHEN CHIEN RU CHEN JUNG ZONE		
发明人	CHEN, CHIEN-RU CHEN, JUNG-ZONE		
IPC分类号	G09G3/36		
CPC分类号	G09G3/20 G09G3/3688 G09G2300/0426 G09G2330/021 G09G2352/00		
优先权	094107564 2005-03-11 TW		
其他公开文献	US7916113		
外部链接	Espacenet USPTO		

摘要(译)

公开了一种液晶显示器，其包括具有像素阵列的面板，输出图像数据和源控制信号的定时控制器，一系列源极驱动器和栅极驱动器。选择一个源极驱动器以通过参考至少一个源控制信号产生栅极控制信号并将其传输到栅极驱动器。因此，栅极驱动器连同源极驱动器可以驱动面板像素。

