



US006671017B2

(12) **United States Patent**
Lyu et al.

(10) **Patent No.:** **US 6,671,017 B2**
(45) **Date of Patent:** **Dec. 30, 2003**

(54) **LIQUID CRYSTAL DISPLAY WITH A WIDE VIEWING ANGLE A COMPENSATION FILM**

(75) Inventors: **Jae-Jin Lyu**, Kyungki-do (KR);
Chang-Hun Lee, Suwon (KR);
Hak-Sun Chang, Seoul (KR)

(73) Assignee: **Samsung Electronics Co., Ltd.**, Suwon (KR)

(*) Notice: Subject to any disclaimer, the term of this patent is extended or adjusted under 35 U.S.C. 154(b) by 199 days.

(21) Appl. No.: **09/879,119**

(22) Filed: **Jun. 13, 2001**

(65) **Prior Publication Data**

US 2003/0043325 A1 Mar. 6, 2003

(30) **Foreign Application Priority Data**

Jun. 13, 2001 (KR) 2000-32506

(51) **Int. Cl.**⁷ **G02F 1/1335**

(52) **U.S. Cl.** **349/118; 349/117; 349/129; 349/143; 349/178; 349/99; 349/130; 349/137**

(58) **Field of Search** **349/118, 129, 349/117, 143, 178, 99, 130, 137**

(56) **References Cited**

U.S. PATENT DOCUMENTS

5,734,455 A	*	3/1998	Yoshida et al.	349/99
6,084,651 A	*	7/2000	Yamahara et al.	349/118
6,108,064 A	*	8/2000	Minoura et al.	349/130
6,163,354 A	*	12/2000	Yamahara et al.	349/117

6,181,400 B1	*	1/2001	Yang et al.	349/117
6,339,460 B1	*	1/2002	Saitoh	349/117
6,342,938 B1	*	1/2002	Song et al.	349/143
6,373,542 B1	*	4/2002	Yamahara et al.	349/118
6,512,568 B2	*	1/2003	Song et al.	349/143
2001/0043302 A1	*	11/2001	Inoue et al.	349/137
2001/0048497 A1	*	12/2001	Miyachi et al.	349/117
2002/0021400 A1	*	2/2002	Lyu et al.	349/178
2002/0063826 A1	*	5/2002	Okamoto et al.	349/117

* cited by examiner

Primary Examiner—Nathan J. Flynn

Assistant Examiner—Fazli Erdem

(74) *Attorney, Agent, or Firm*—McGuireWoods LLP

(57) **ABSTRACT**

Disclosed is a liquid crystal display comprising a liquid crystal cell including a pair of transparent substrates, with orientation layers deposited on inner surfaces thereof, and a liquid crystal layer of liquid crystal material injected between the substrates; biaxial compensation films provided on outer surfaces of the liquid crystal cell, the biaxial compensation films including an optical dielectric material layer; and polarization plates provided on outer surfaces of the biaxial compensation films, wherein if "d" is set as a cell gap of the liquid crystal cell, "R_{LC}" is set as a phase retardation value of the liquid crystal layer, an axis perpendicular to planes made by the substrates is set as a z-axis, x-axis and y-axis are formed on a planar surface of the substrates, and refractive indices of molecules comprising the biaxial compensation films in the x, y and z directions are denoted by n_x, n_y and n_z, retardation values (n_y-n_x)*d and (n_z-n_x)*d of the biaxial compensation films being respectively within ranges of -30±5 nm and -R_{LC}/4±15 nm.

13 Claims, 12 Drawing Sheets

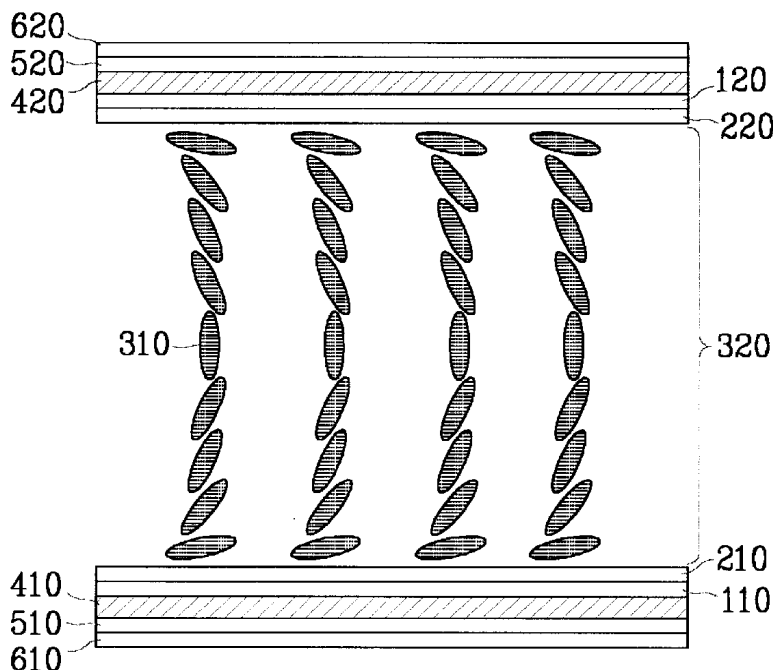

FIG. 1

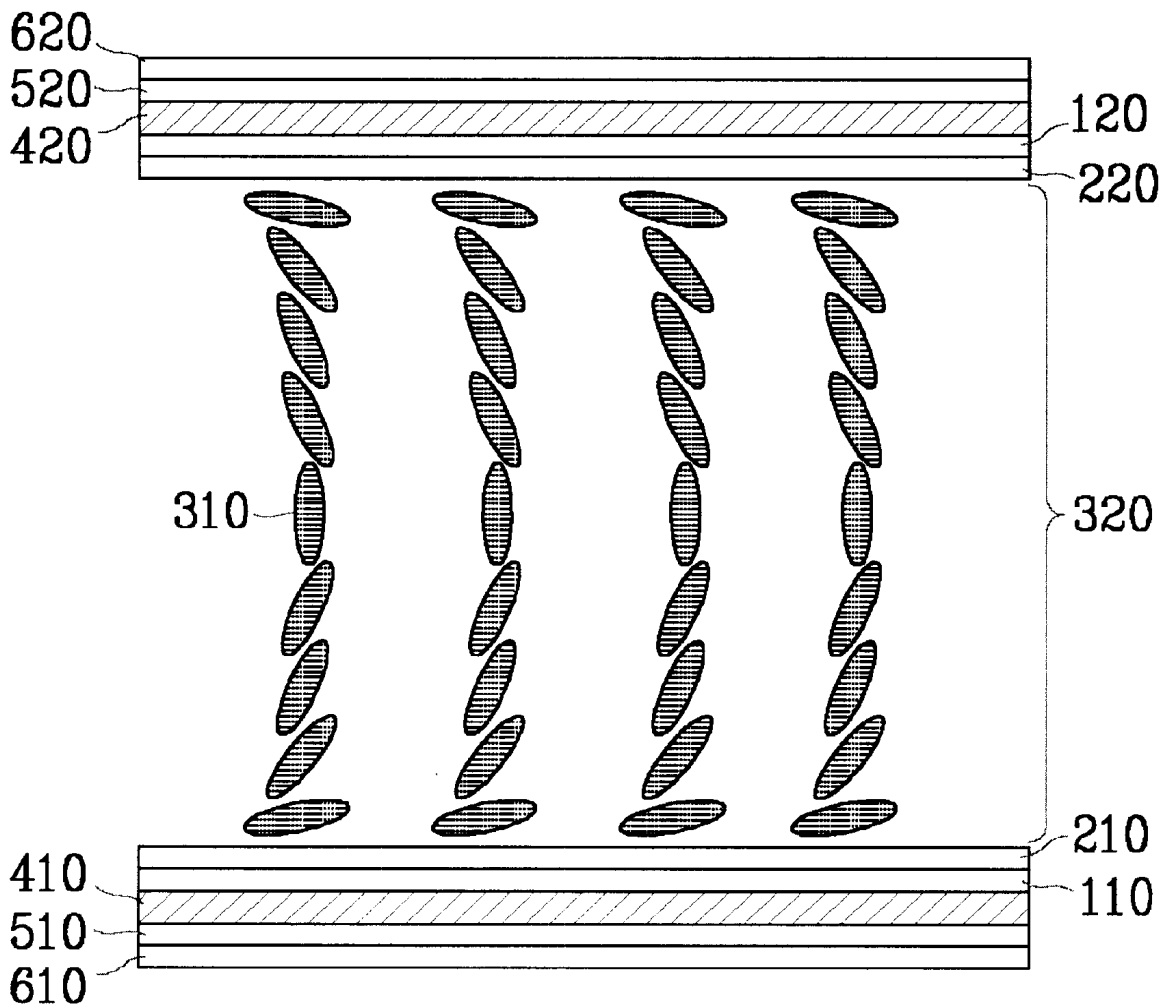

FIG. 2

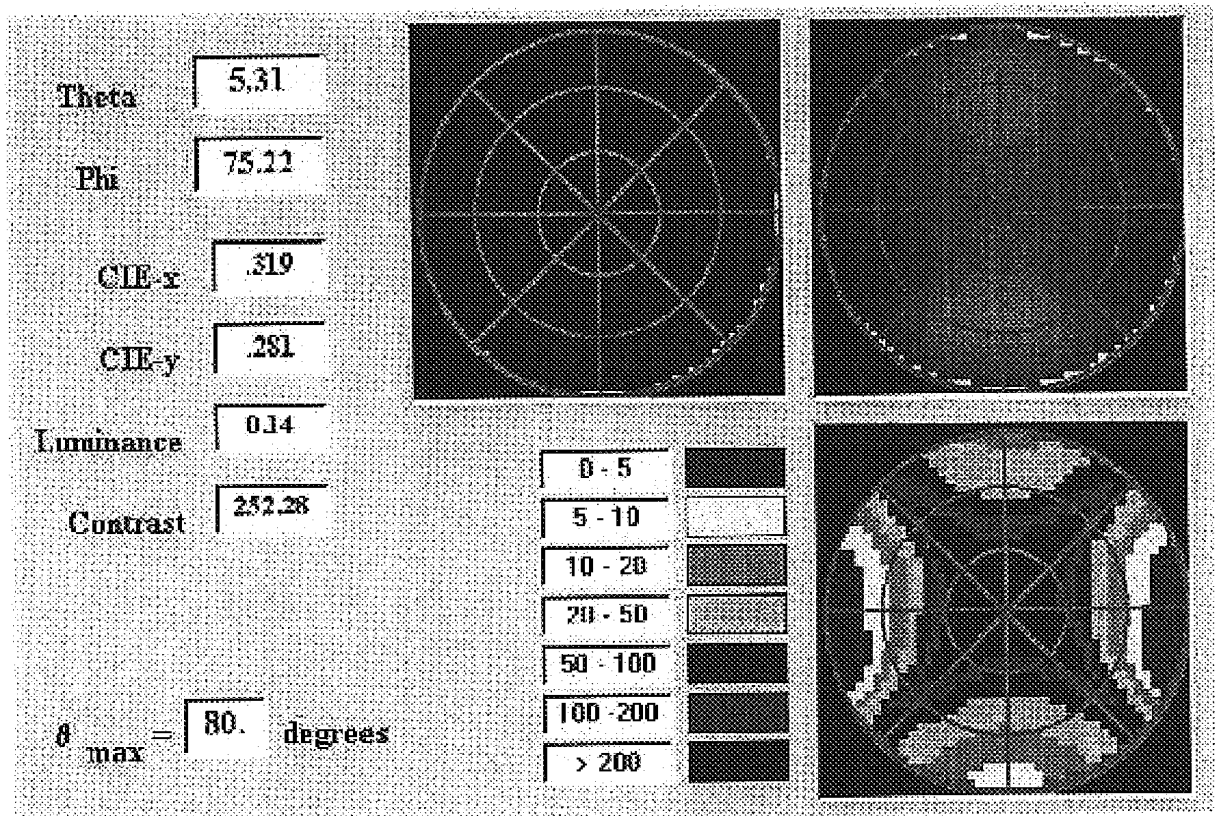

FIG.3

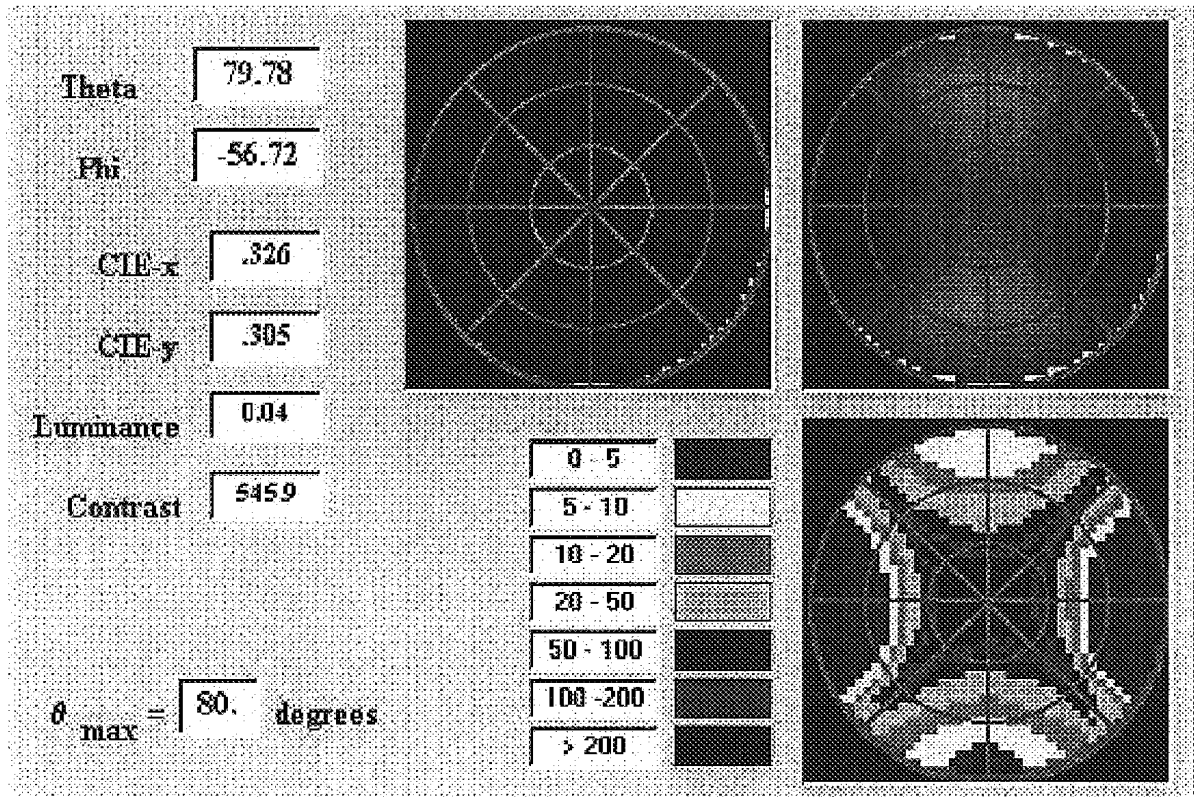

FIG.4A

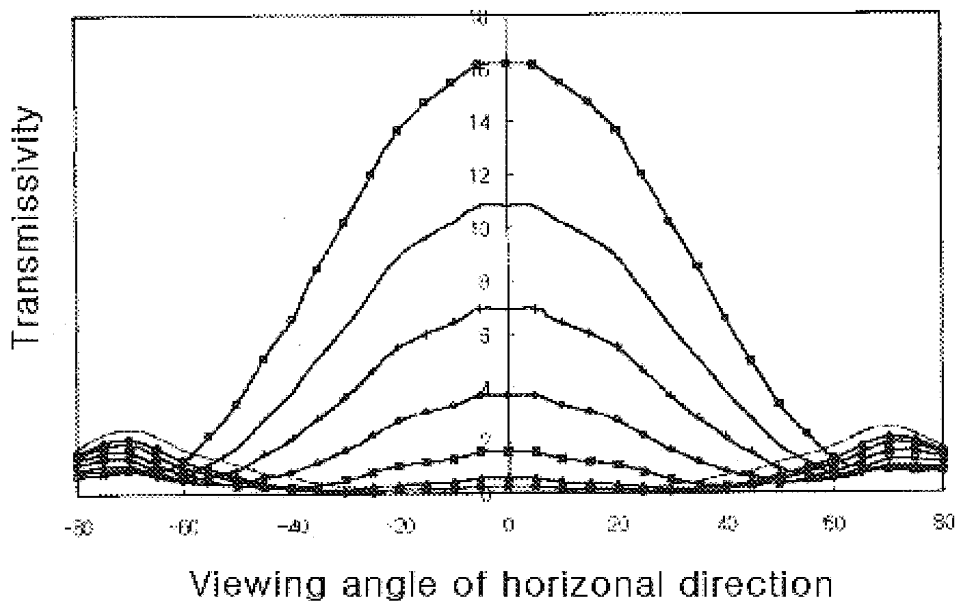

FIG.4B

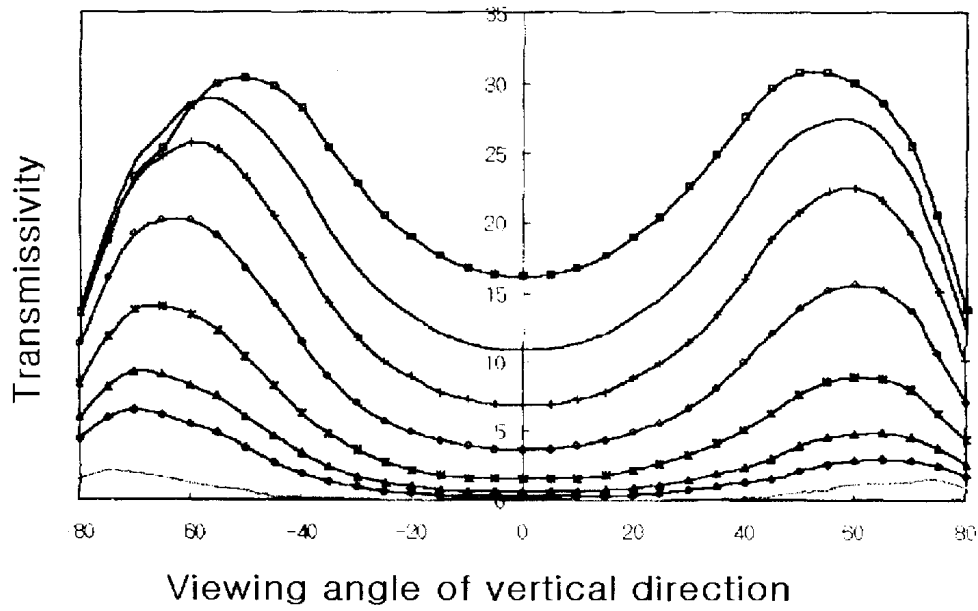

FIG.4C

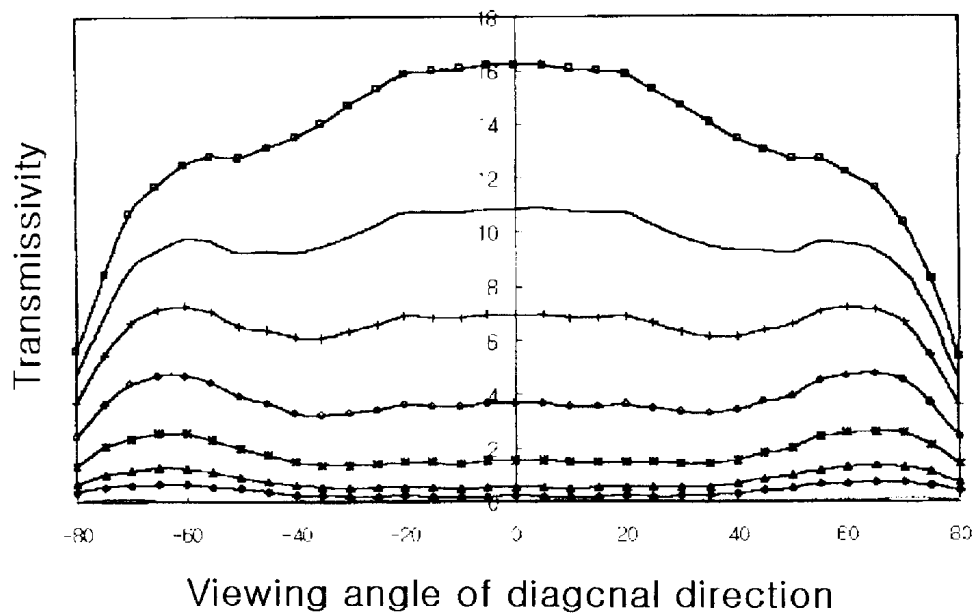

FIG.5

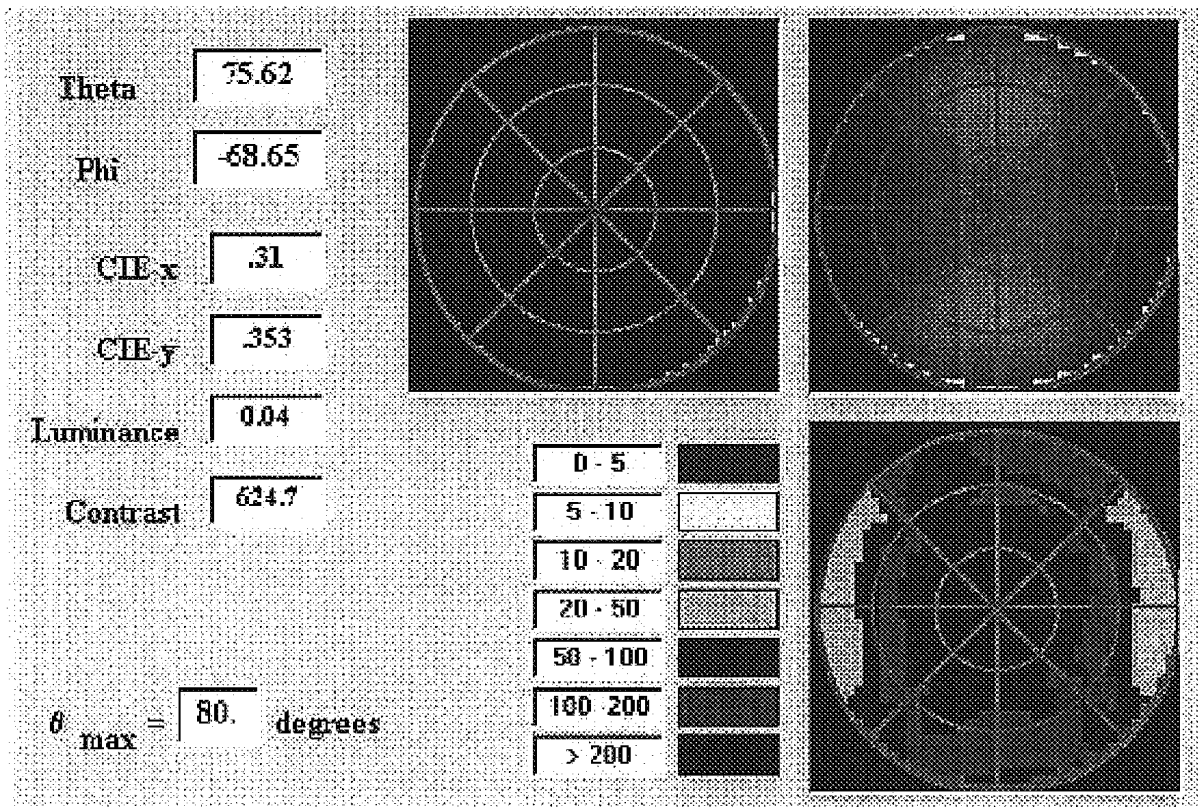

FIG. 6

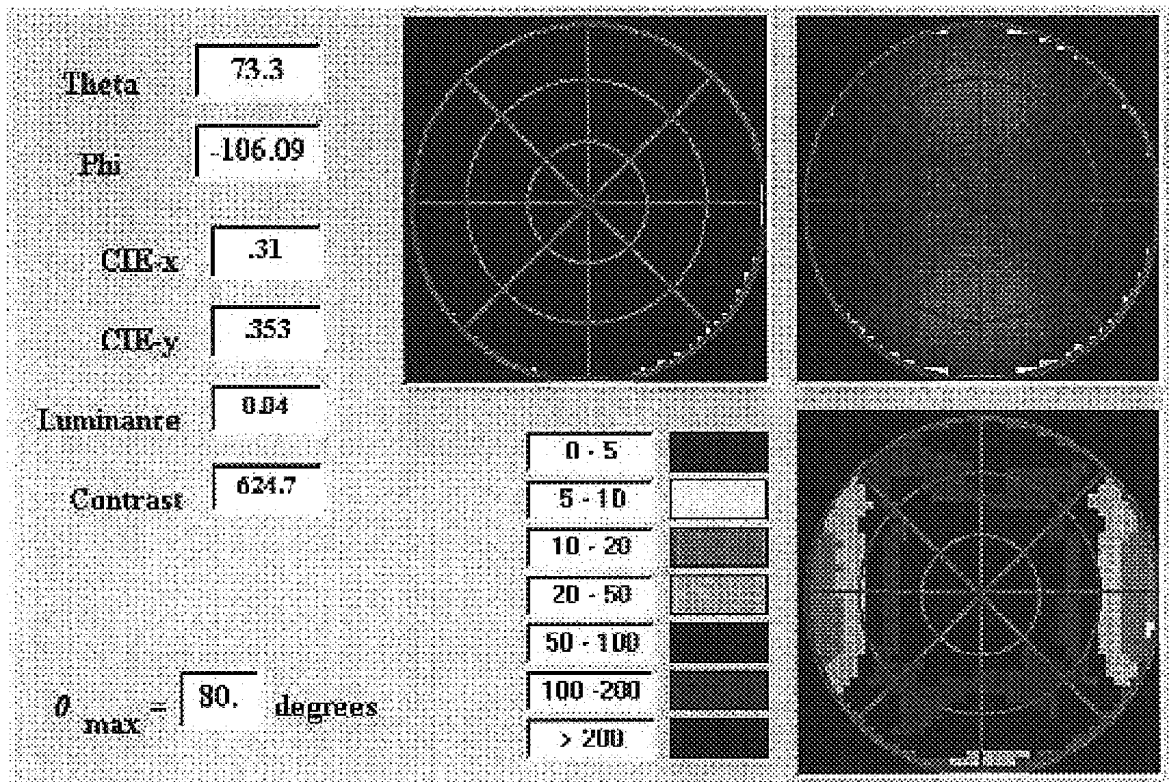

FIG. 7

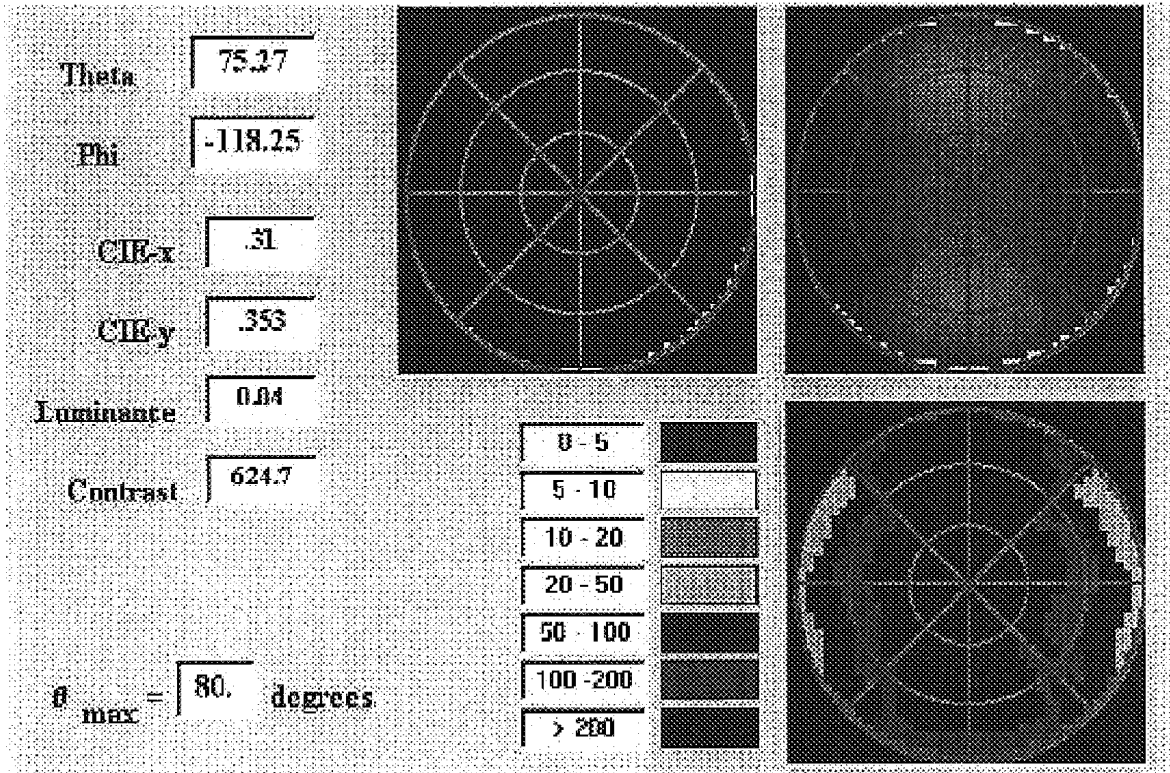

FIG. 8A

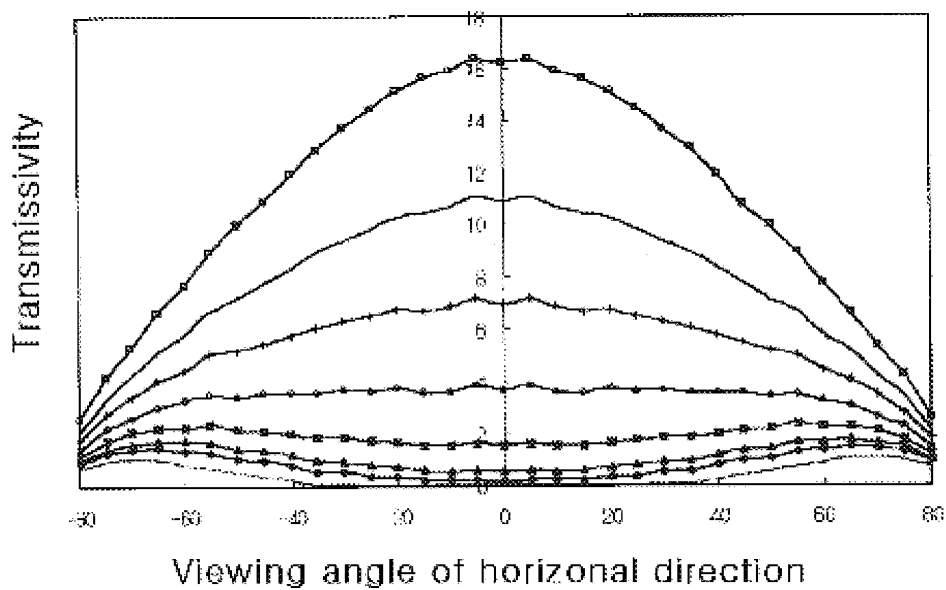

FIG.8B

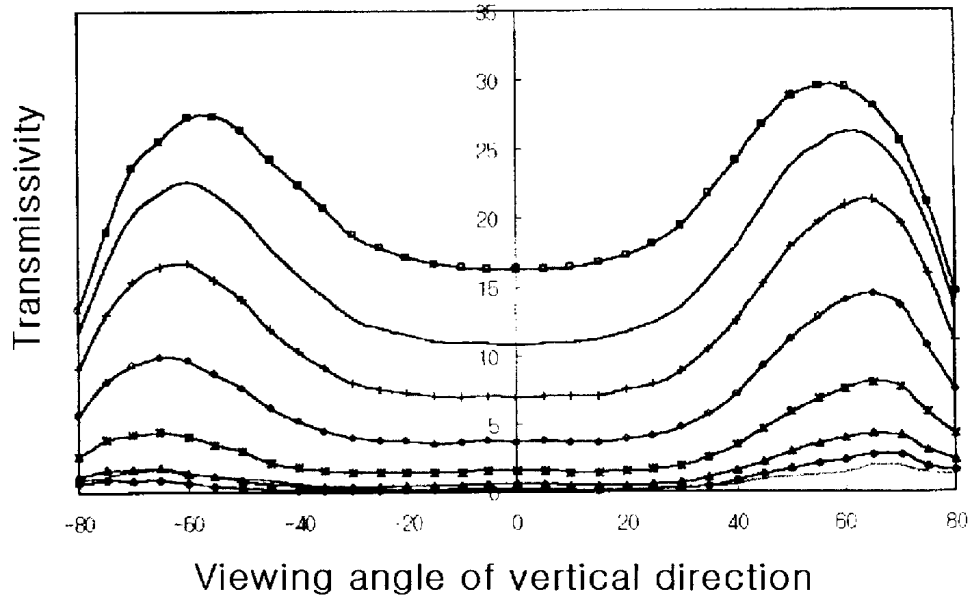

FIG.8C

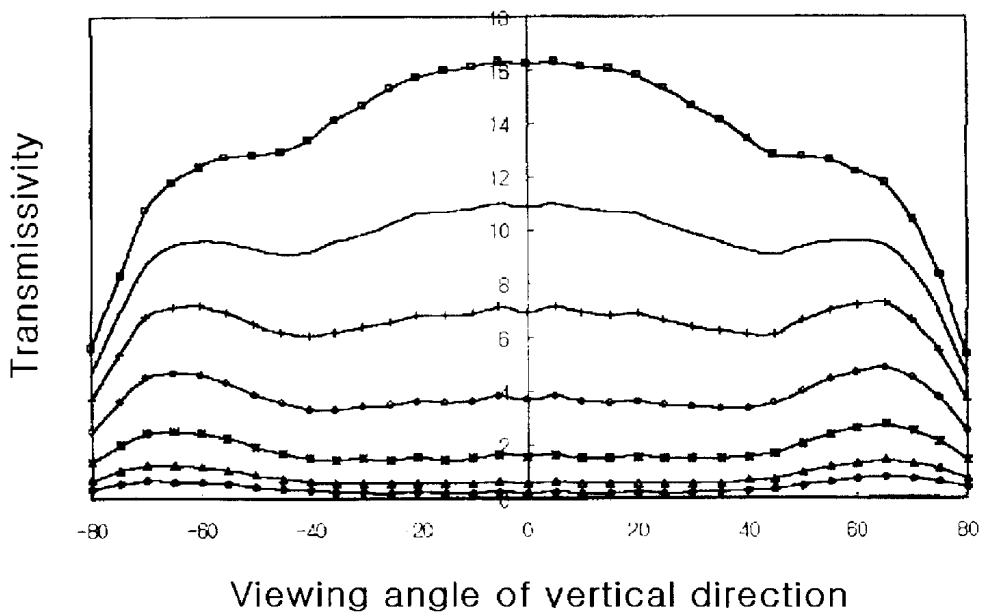

FIG. 9

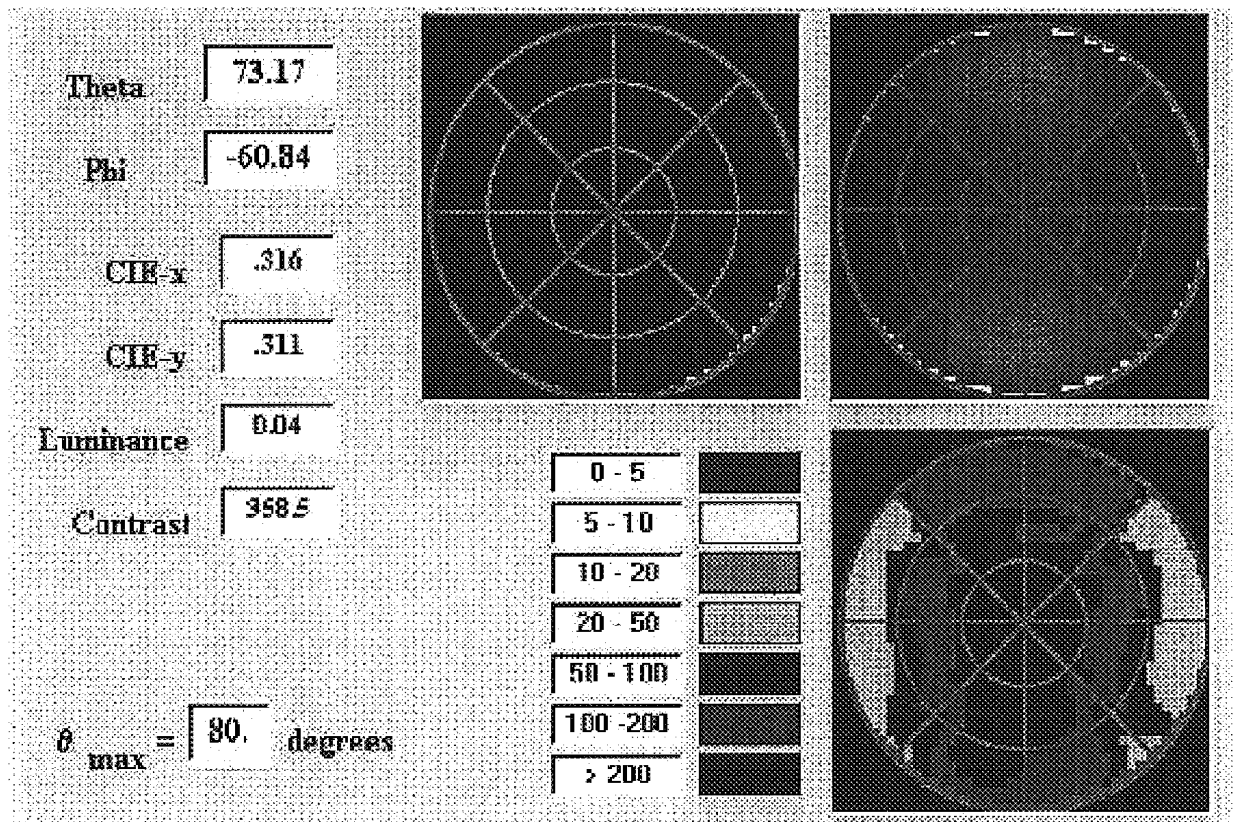

FIG. 10

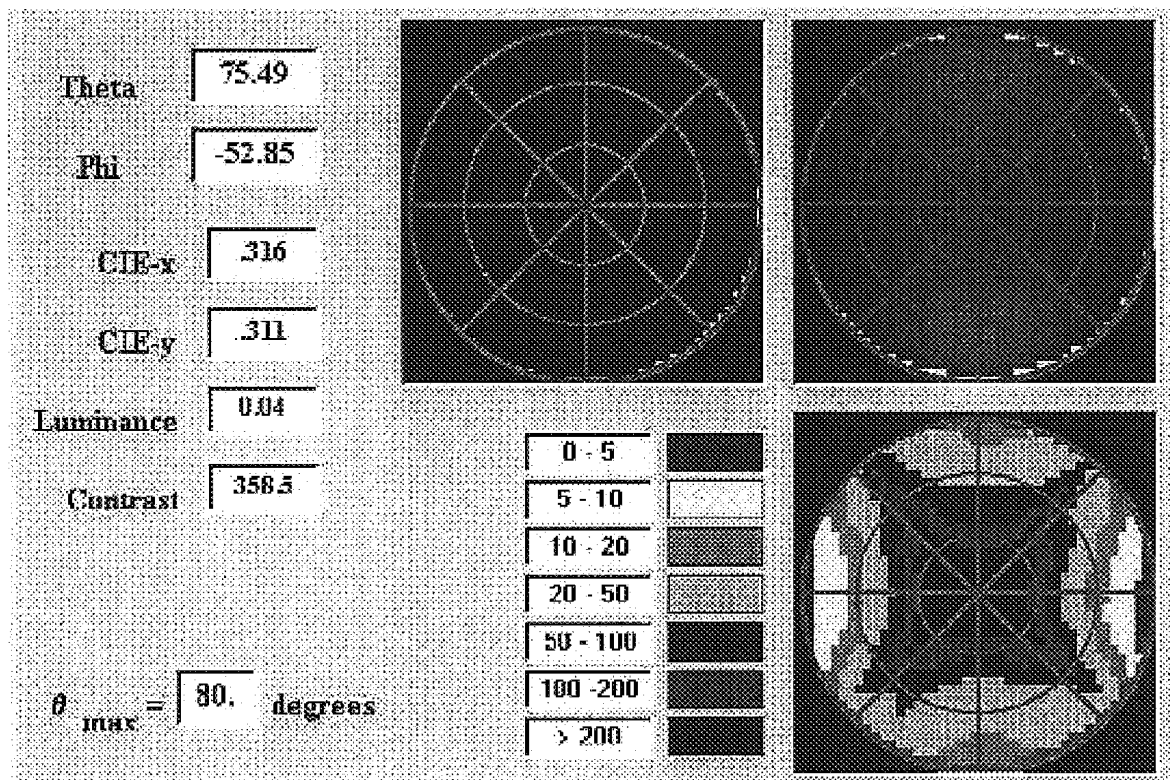

FIG. 11

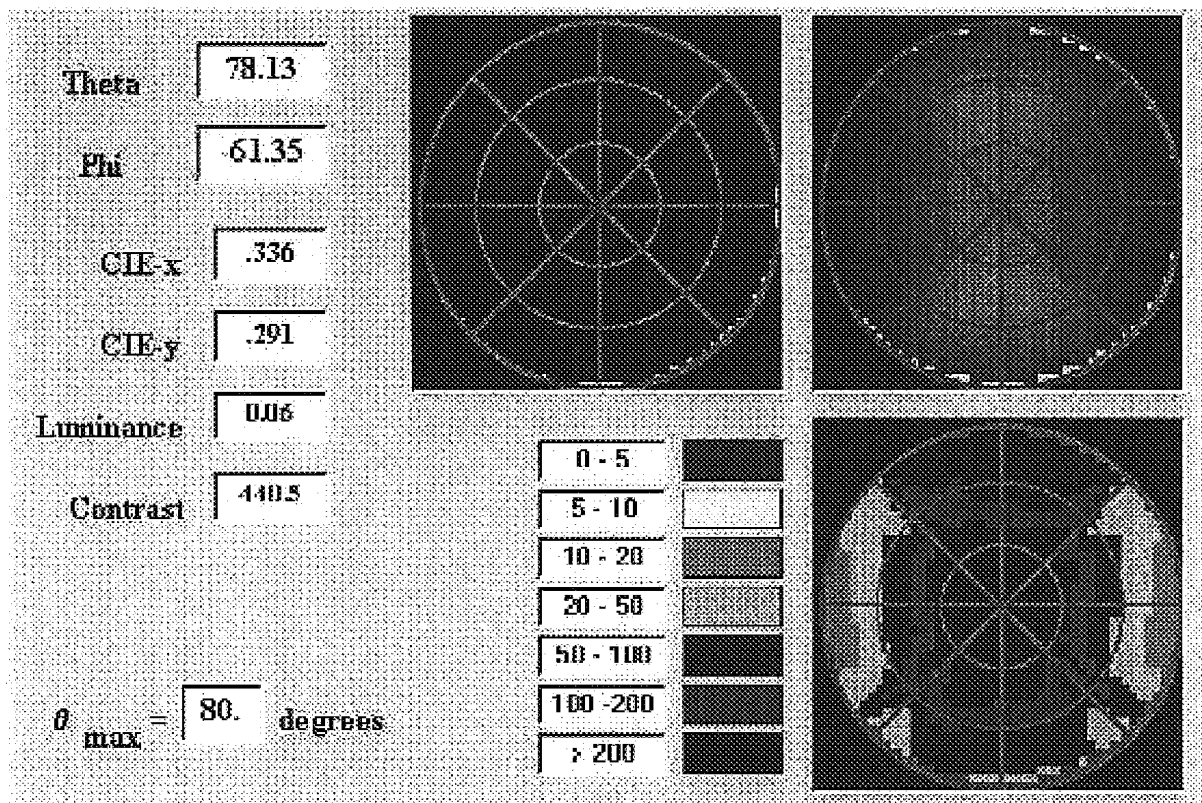
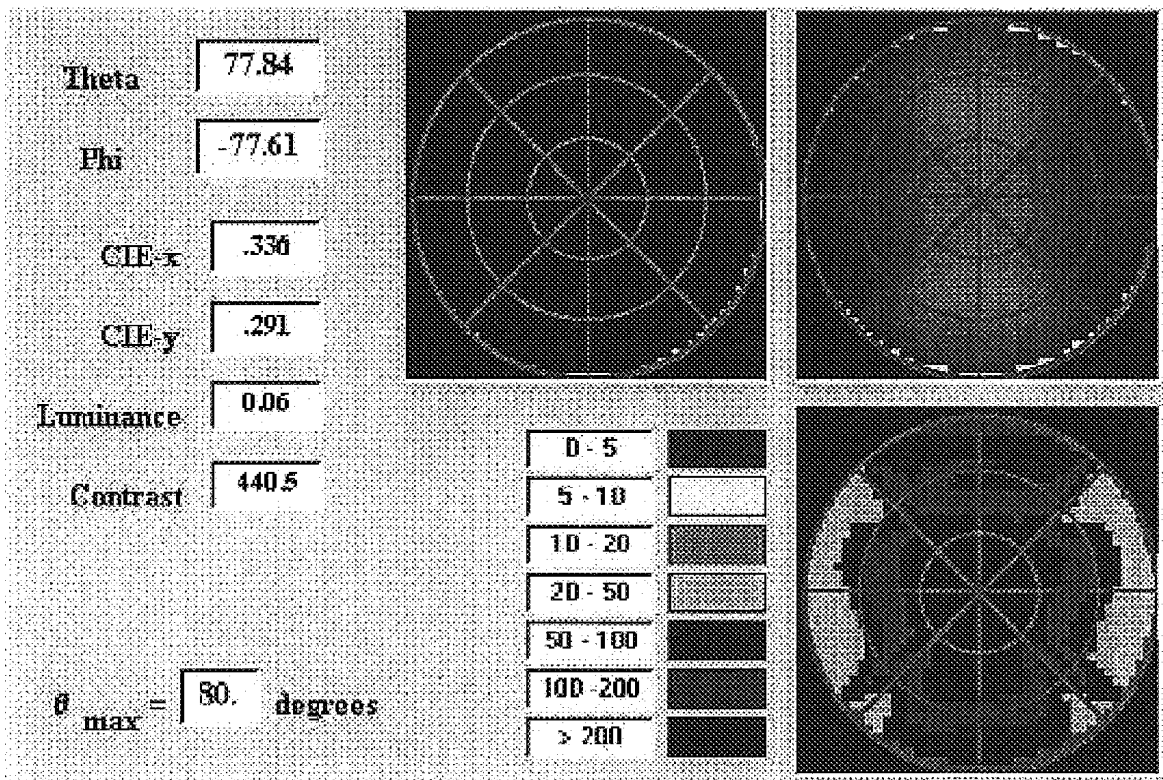

FIG.12



LIQUID CRYSTAL DISPLAY WITH A WIDE VIEWING ANGLE A COMPENSATION FILM

BACKGROUND OF THE INVENTION

(a) Field of the Invention

The present invention relates to a liquid crystal display having a wide viewing angle and using a compensation film.

(b) Description of the Related Art

Liquid crystal displays are typically structured including two substrates provided substantially in parallel with a predetermined gap therebetween, and liquid crystal material is injected between the opposing substrates. Each substrate includes an electrode, and an electric field is formed between the substrates by applying a voltage of a different potential to the electrodes. Accordingly, the alignment of liquid crystal molecules of the liquid crystal material changes to control the transmittance of incident light, thereby showing images.

Various types of liquid crystal displays have been developed to improve response times and viewing angle. They include the HAN (hybrid aligned nematic) mode liquid crystal display and the OCB (optically compensated bend) mode liquid crystal display. The OCB mode LCD is arranged symmetrically about an imaginary center plane between the two substrates and parallel to the same. That is, the liquid crystal molecules are aligned substantially parallel to the substrates, then are increasingly slanted until reaching this center plane where the liquid crystal molecules are substantially perpendicular to the two substrates. A wide viewing angle is achieved as a result. To obtain such a bent alignment of the liquid crystal molecules, a horizontal orientation agent that is oriented in the same direction is used and a high voltage is initially applied. Also, the move of liquid crystal molecules in the same orientation when operating, realizes a wide viewing angle as well as fast response times.

However, since liquid crystal material has a birefringence where a refraction index of long axes of the liquid crystal molecules is different from that of short axes of the liquid crystal molecules, a different viewing angle may generate a different refraction index. Accordingly, the ratio of polarization becomes different when the linearly polarized light passes through the liquid crystals. Thus, the amount and color characteristics of the light vary depending on the viewing angle. Hence, color shifting, gray inversion and variations in a contrast ratio happen in the LCD as the viewing angle changes.

An OCB mode LCD is disclosed in U.S. Pat. Nos. 5,410,422 and 5,805,253, in which a compensation film is used to compensate for a phase difference in liquid crystal cells. In these applications, a change in phase of light in liquid crystals is compensated in an opposite direction by the compensation film to solve the viewing angle problem. Here, a uniaxial or biaxial compensation film is used. In U.S. Pat. No. 5,410,422, a retardation value of the uniaxial compensation film is limited to 60–85% of a retardation value of the liquid crystal cells, while a phase difference value of the biaxial compensation film of U.S. Pat. No. 5,805,253 is limited to 0–100 nm.

SUMMARY OF THE INVENTION

The present invention has been made in an effort to solve the above problems.

It is an object of the present invention to provide a liquid crystal display having a wide viewing angle that uses a

compensation film, which minimizes color shifting and prevents gray inversion.

To achieve the above object, the present invention provides a liquid crystal display comprising a liquid crystal cell including a pair of transparent substrates with orientation layers deposited on inner surfaces thereof, and a liquid crystal layer realized through liquid crystal material injected between the substrates; biaxial compensation films provided on outer surfaces of the liquid crystal cell, the biaxial compensation films including an optical dielectric material layer; and polarization plates provided on outer surfaces of the biaxial compensation films, wherein if “d” is set as a cell gap of the liquid crystal cell, “ R_{LC} ” is set as a phase retardation value of the liquid crystal layer, an axis perpendicular to planes made by the substrates is set as a z-axis, x-axis and y-axis are formed on a planar surface of the substrates, and refractive indexes of molecules comprising the biaxial compensation films in the x, y and z directions are denoted by n_x , n_y and n_z , retardation values $(n_y - n_x) \cdot d$ and $(n_z - n_x) \cdot d$ of the biaxial compensation films being respectively within ranges of -30 ± 5 nm and $-R_{LC}/4 \pm 15$ nm.

According to a feature of the present invention, liquid crystal molecules of the liquid crystal layer have a symmetrically bent alignment about an imaginary axis parallel and equidistant to the pair of substrates.

According to another feature of the present invention, the material layer of the biaxial compensation films is an optical dielectric material having a negative anisotropy.

According to yet another feature of the present invention, the liquid crystal display further comprises hybrid C plate compensation films provided between the liquid crystal cell and the biaxial compensation films.

In another aspect, the present invention provides a liquid crystal display comprising a liquid crystal cell including a pair of transparent substrates with orientation layers deposited on inner surfaces thereof, and a liquid crystal layer realized through liquid crystal material injected between the substrates; biaxial compensation films provided on at least one outer surface of the liquid crystal cell, the biaxial compensation films including an optical dielectric material layer; and polarization plates provided on outer surfaces of the biaxial compensation films, wherein if “d” is set as a cell gap of the liquid crystal cell, “ R_{LC} ” is set as a phase retardation value of the liquid crystal layer, an axis perpendicular to planes made by the substrates is set as a z-axis, x-axis and y-axis are formed on a planar surface of the substrates, and refractive indexes of molecules comprising the biaxial compensation films in the x, y and z directions are denoted by n_x , n_y and n_z , retardation values $(n_y - n_x) \cdot d$ and $(n_z - n_x) \cdot d$ of the biaxial compensation films being respectively within ranges of -60 ± 10 nm and $-R_{LC}/2 \pm 30$ nm.

According to a feature of the present invention, liquid crystal molecules of the liquid crystal layer have a symmetrically bent alignment about an imaginary axis parallel and equidistant to the pair of substrates.

According to another feature of the present invention, the material layer of the biaxial compensation films is an optical dielectric material having a negative anisotropy.

According to yet another feature of the present invention, the liquid crystal display further comprises hybrid C plate compensation films provided between the liquid crystal cell and the biaxial compensation films.

BRIEF DESCRIPTION OF THE DRAWINGS

The accompanying drawings, which are incorporated in and constitute a part of the specification, illustrate an

embodiment of the invention, and, together with the description, serve to explain the principles of the invention:

FIG. 1 is a partial sectional view of a liquid crystal display having a bent alignment of liquid crystal molecules according to a preferred embodiment of the present invention; and

FIGS. 2, 3, 4A, 4B, 4C, 5, 6, 7, 8A, 8B, 8C, 9, 10, 11 and 12 describe viewing angle characteristics of the present invention.

DETAILED DESCRIPTION OF THE PREFERRED EMBODIMENTS

Preferred embodiments of the present invention will now be described in detail with reference to the accompanying drawings.

FIG. 1 shows a partial sectional view of a liquid crystal display having a bent alignment of liquid crystal molecules according to a preferred embodiment of the present invention.

As shown in the drawing, a liquid crystal display of the present invention includes a pair of opposing transparent insulating substrates **110** and **120**; orientation layers **210** and **220** formed on inner surfaces of the substrates **110** and **120**, respectively; a liquid crystal layer **320** formed of liquid crystal material injected between the substrates **110** and **120**, the liquid crystal material being comprised of liquid crystal molecules **310**; hybrid C plate compensation films **410** and **420** formed on outer surfaces of the substrates **110** and **120**, respectively; biaxial compensation films **510** and **520** provided on outer surfaces of the hybrid C plate compensation films **410** and **420**, respectively; and polarization plates **610** and **620** provided on outer surfaces of the biaxial compensation films **510** and **520**, respectively.

The liquid crystal layer **320** has a positive dielectric anisotropy. If a critical voltage is applied to the liquid crystal layer **320**, the liquid crystal molecules **310** adjacent to the substrates **110** and **120** are aligned to a pretilt angle with respect to the substrates **110** and **120** as a result of properties of the liquid crystal molecules **310** and an orientation force of the orientation layers **210** and **220**. Further, as approaching an imaginary plane, which is positioned parallel to the substrates **110** and **120** at a center thereof, the liquid crystal molecules **310** are increasingly bent by the decreasing influence of the orientation force and the increasing influence of an electric field vertical to the substrates **110** and **120**. Accordingly, a symmetrical arrangement about the imaginary plane is formed by the liquid crystal molecules **310**, resulting in two distinct regions. As a result of this alignment, a phase retardation of light passing through the liquid crystal layer **320** is compensated symmetrically about the imaginary plane such that a wide viewing angle is obtained.

The orientation layers **210** and **220** are horizontal orientation layers that provide an orientation force to the liquid crystal molecules **310** in a direction horizontal to the substrates **110** and **120**. The orientation layers **210** and **220** undergo an orientation process such that they provide an orientation force in the same direction, thereby obtaining the symmetrical arrangement of the liquid crystal molecules **310** about the imaginary plane.

The hybrid C plate compensation films **410** and **420** are made of a compound material having a negative dielectric anisotropy such as the WV film made by Fuji Film. The hybrid C plate compensation films **410** and **420** align short axes of molecules having a discotic molecule structure such that they have an increasingly larger angle with respect to a line normal to the substrates **110** and **120**.

If an axis perpendicular to planes made by the substrates **110** and **120** is set as a z-axis, x-axis and y-axis are formed on a planar surface of the substrates **110** and **120**, and refractive indexes of molecules comprising the compensation films **510** and **520** in the x, y and z directions are denoted by n_x , n_y and n_z , the biaxial compensation films **510** and **520** are structured such that $n_x > n_y > n_z$. Retardation values $(n_y - n_x) \cdot d$ and $(n_z - n_x) \cdot d$ of the biaxial compensation films **510** and **520** are respectively within ranges of -30 ± 5 nm and $-R_{LC}/4 \pm 15$ nm. And when only one of the two biaxial compensation films **510** and **520** is used, retardation values $(n_y - n_x) \cdot d$ and $(n_z - n_x) \cdot d$ are respectively in the ranges of -60 ± 10 nm and $-R_{LC}/2 \pm 30$ nm. This will be described in more detail hereinafter using results of an experiment as an example. Here, "d" refers to a cell gap of liquid crystal cells and " $-R_{LC}$ " refers to a phase retardation value of the liquid crystal layer **320**.

The polarization plates **610** and **620** act to polarize light only in the direction of a transmission axis of the polarizing plates **610** and **620**. The transmission axis of the polarizing plates **610** and **620** can be either in a vertical or planar direction, with respect to the substrates **110** and **120**.

FIGS. 2, 3, 4A, 4B, 4C, 5, 6, 7, 8A, 8B, 8C, 9, 10, 11 and 12 are views used to describe viewing angle characteristics of the present invention. In the drawings, Theta and Phi refer respectively to an azimuth angle and a polar angle. Also, CIE_{-x} and CIE_{-y} refer to positions of a bright state in the CIE1976 standard color chart. Luminance and Contrast in the drawings have their normal meanings, and θ_{max} refers to a maximum viewing angle.

In Experiments 1 through 3, the hybrid C plate compensation films **410** and **420** include a liquid crystal layer containing liquid crystal molecules having a discotic molecular structure and a negative anisotropic dielectric value, and a base film containing liquid crystal material. At this time, an angle made by the liquid crystal molecules from the body to an adjacent substrate **110** or **120** slowly increases from 4° to 68° . A direction to which an absolute value of a phase difference is at a minimum is a direction slanted 21° from a vertical surface of the base film. Here, a phase difference of the liquid crystal layer of the hybrid C plate compensation films **410** and **420** is 117 nm, and a phase difference of the base film is 40 nm. Further, a drive voltage used to display a bright state is 2V, while a drive voltage used to display a dark state is 6V.

Experiment 1

FIGS. 2, 3, 5, 6 and 7 show pictures of a dark state, bright state and contrast ratio of Experiment 1. FIGS. 4A, 4B and 4C illustrate a gray inversion of the Experiment of FIG. 3 according to angle variations with respect to a horizontal direction, vertical direction and a diagonal direction. FIGS. 8A, 8B and 8C illustrate a gray inversion of the experiment of FIG. 5 according to angle variations with respect to a horizontal direction, vertical direction and a diagonal direction.

In Experiment 1, a dark state, a bright state and a contrast ratio are measured as a phase difference of the biaxial compensation films **510** and **520** (FIG. 1) is varied in the case where a liquid crystal cell gap is $6.0 \mu\text{m}$ and a refractive index dielectric value of the liquid crystal layer **320** (FIG. 1) is 0.15.

FIG. 2 shows pictures of viewing angle characteristics when a planar phase difference $(n_y - n_x) \cdot d$ of the biaxial compensation films **510** and **520** (FIG. 1) is $-4 \mu\text{m}$ and a phase difference $(n_z - n_x) \cdot d$ in a normal direction is $-228 \mu\text{m}$. As shown in the drawing, in the dark state, light leaks a lot and a contrast ratio is measured less than 10 at a viewing angle of 80° .

FIG. 3 shows pictures of viewing angle characteristics when the planar phase difference $(n_y - n_x) \cdot d$ of the biaxial compensation films 510 and 520 (FIG. 1) is $-10 \mu\text{m}$ and the phase difference $(n_z - n_x) \cdot d$ in a normal direction is $-300 \mu\text{m}$. As shown in the drawing, in the bright state, light leaks a lot and a contrast ratio is measured less than 10 at a viewing angle of 80° . Further, with reference to FIG. 4A, it is evident from transmissivity measurements that gray inversion occurs.

FIG. 5 shows pictures of viewing angle characteristics when the planar phase difference $(n_y - n_x) \cdot d$ of the biaxial compensation films 510 and 520 (FIG. 1) is $-30 \mu\text{m}$ at $-30 \pm 5 \text{ nm}$ and the phase difference $(n_z - n_x) \cdot d$ in a normal direction is $-228 \mu\text{m}$ in the range of $-R_{LC}/4 \pm 15 \text{ nm}$. As shown in the drawing, the leakage of light in the dark and bright states is reduced, and a contrast ratio of greater than 20 is obtained at a viewing angle of 80° . Further, with reference to FIG. 8A, it is evident that gray inversion does not occur.

FIGS. 6 and 7 show pictures of viewing angle characteristics when the planar phase difference $(n_y - n_x) \cdot d$ of the biaxial compensation films 510 and 520 (FIG. 1) is $30 \mu\text{m}$ and the phase difference $(n_z - n_x) \cdot d$ in a normal direction is $-218 \mu\text{m}$ and $238 \mu\text{m}$. As shown in the drawings, the leakage of light in the dark and bright states is reduced when compared to FIGS. 2 and 3, and a contrast ratio of greater than 10 and 20 is obtained at a viewing angle of 80° .

Experiment 2

FIGS. 9 and 10 show pictures of a dark state, bright state and contrast ratio of Experiment 2. In Experiment 2, a dark state, a bright state and a contrast ratio are measured as the phase difference of the biaxial compensation films 510 and 520 (FIG. 1) is varied in the case where a liquid crystal cell gap is $6.0 \mu\text{m}$ and a refractive index dielectric value of the liquid crystal layer 320 (FIG. 1) is 0.12. The hybrid C plate compensation films 410 and 420 (FIG. 1) are identical to Experiment 1.

FIG. 9 shows pictures of viewing angle characteristics in the case where the planar phase difference $(n_y - n_x) \cdot d$ of the biaxial compensation films 510 and 520 (FIG. 1) is $-35 \mu\text{m}$ at $-30 \pm 5 \text{ nm}$ and the phase difference $(n_z - n_x) \cdot d$ in a normal direction is $-180 \mu\text{m}$ in the range of $-R_{LC}/4 \pm 15 \text{ nm}$. As shown in the drawing, the leakage of light in the dark and bright states is reduced, and a contrast ratio of greater than 20 is obtained at a viewing angle of 80° .

FIG. 10 shows pictures of viewing angle characteristics in the case where the planar phase difference $(n_y - n_x) \cdot d$ of the biaxial compensation films 510 and 520 (FIG. 1) is $-35 \mu\text{m}$ at $-30 \pm 5 \text{ nm}$ and the phase difference $(n_z - n_x) \cdot d$ in a normal direction is $-148 \mu\text{m}$ in the range of $-R_{LC}/4 \pm 15 \text{ nm}$. As shown in the drawing, an extremely poor contrast ratio is obtained at a viewing angle of 80° .

Experiment 3

FIGS. 11 and 12 show pictures of a dark state, bright state and contrast ratio of Experiment 3. In Experiment 3, a dark state, a bright state and a contrast ratio are measured as the phase difference of the biaxial compensation films 510 and 520 (FIG. 1) varies when a liquid crystal cell gap is $6.0 \mu\text{m}$ and a refractive index dielectric value of the liquid crystal layer 320 (FIG. 1) is 0.167. The hybrid C plate compensation films 410 and 420 (FIG. 1) are identical to Experiments 1 and 2.

FIGS. 11 and 12 show pictures of viewing angle characteristics in the case where the planar phase difference $(n_y - n_x) \cdot d$ of the biaxial compensation films 510 and 520 (FIG. 1) is $-30 \mu\text{m}$ at $-30 \pm 5 \text{ nm}$ and the phase difference

$(n_z - n_x) \cdot d$ in a normal direction is $-255 \mu\text{m}$ and $-265 \mu\text{m}$ in the range of $-R_{LC}/4 \pm 15 \text{ nm}$. As shown in the drawings, the leakage of light in the dark and bright states is reduced, and a contrast ratio of greater than 10 and 20 is obtained at a viewing angle of 80° .

In the liquid crystal display of the present invention described above, with the use of the biaxial compensation films of a planar phase difference $(n_y - n_x) \cdot d$ in the range of $-60 \pm 10 \text{ nm}$ and a phase difference $(n_z - n_x) \cdot d$ in a normal direction in the range of $-R_{LC}/2 \pm 30 \text{ nm}$, a wide viewing angle and a high contrast ratio are obtained. Further, color shifting is minimized and gray inversion is prevented.

Although preferred embodiments of the present invention have been described in detail hereinabove, it should be clearly understood that many variations and/or modifications of the basic inventive concepts herein taught which may appear to those skilled in the present art will still fall within the spirit and scope of the present invention, as defined in the appended claims.

What is claimed is:

1. A liquid crystal display, comprising:

a liquid crystal cell including a pair of transparent substrates with orientation layers deposited on inner surfaces thereof; and a liquid crystal layer of liquid crystal material injected between the substrates;

biaxial compensation films provided on outer surfaces of said liquid crystal cell, said biaxial compensation films including an optical dielectric material layer; and

polarization plates provided on outer surfaces of said biaxial compensation films,

wherein retardation values $(n_y - n_x) \cdot d$ and $(n_z - n_x) \cdot d$ of the biaxial compensation films are respectively within ranges of $-30 \pm 5 \text{ nm}$ and $-R_{LC}/4 \pm 15 \text{ nm}$,

where "d" is set as a cell gap of the liquid crystal cell, "R_{LC}" is set as a phase retardation value of the liquid crystal layer, an axis perpendicular to planes made by the pair of transparent substrates is set as a z-axis, x-axis and y-axis are formed on a planar surface of the substrates, and refractive indices of molecules comprising the biaxial compensation films in the x, y and z directions are denoted by n_x, n_y and n_z.

2. The liquid crystal display of claim 1, wherein liquid crystal molecules of the liquid crystal layer have a symmetrically bent alignment about an imaginary axis parallel and equidistant to the pair of transparent substrates.

3. The liquid crystal display of claim 1, wherein the material layer of the biaxial compensation films is an optical dielectric material having a negative anisotropy.

4. The liquid crystal display of claim 1, further comprising hybrid C plate compensation films provided between the liquid crystal cell and the biaxial compensation films.

5. A liquid crystal display, comprising:

a liquid crystal cell including a pair of transparent substrates with orientation layers deposited on inner surfaces thereof; and a liquid crystal layer of liquid crystal material injected between the substrates;

biaxial compensation films provided on at least one outer surface of the liquid crystal cell, the biaxial compensation films including an optical dielectric material layer; and

polarization plates provided on outer surfaces of the biaxial compensation films,

wherein retardation values $(n_y - n_x) \cdot d$ and $(n_z - n_x) \cdot d$ of the biaxial compensation films are respectively within ranges of $-60 \pm 10 \text{ nm}$ and $-R_{LC}/2 \pm 30 \text{ nm}$,

7

where “d” is set as a cell gap of the liquid crystal cell, “ R_{LC} ” is set as a phase retardation value of the liquid crystal layer, an axis perpendicular to planes made by the pair of transparent substrates is set as a z-axis, x- and y-axes are formed on a planar surface of the substrates, and refractive indexes of molecules comprising the biaxial compensation films in the x, y and z directions are denoted by n_x , n_y and n_z .

6. The liquid crystal display of claim 5, wherein liquid crystal molecules of the liquid crystal layer have a symmetrically bent alignment about an imaginary axis parallel and equidistant to the pair of substrates.

7. The liquid crystal display of claim 5, wherein the material layer of the biaxial compensation films is an optical dielectric material having a negative anisotropy.

8. The liquid crystal display of claim 5, further comprising hybrid C plate compensation films provided between the liquid crystal cell and the biaxial compensation films.

9. A liquid crystal display, comprising:

a liquid crystal cell including a pair of transparent substrates including orientation layers on inner surfaces of the pair of transparent substrates;

a liquid crystal layer of liquid crystal material arranged between the pair of transparent substrates, wherein liquid crystal molecules of the liquid crystal layer are substantially symmetric relative to an imaginary axis parallel and substantially equidistant from the pair of transparent substrates;

biaxial compensation provided on outer surfaces of said liquid crystal cell, said biaxial compensation films

8

including an optical dielectric material layer, wherein retardation values $(n_y - n_x) \cdot d$ and $(n_z - n_x) \cdot d$ of the biaxial compensation films are respectively within ranges of -30 ± 5 nm and $-R_{LC}/4 \pm 15$ nm,

wherein “d” is set as a cell gap of the liquid crystal cell, “ R_{LC} ” is a phase retardation value of the liquid crystal layer, an axis perpendicular to planes made by the pair of transparent substrates is set as a z-axis,

wherein x-axis and y-axis are formed on a planar surface of the substrates, and

wherein refractive indices of molecules comprising the biaxial compensation films in the x, y and z directions are denoted by n_x , n_y and n_z ,

wherein $n_x > n_y > n_z$; and

polarization plates provided on outer surfaces of said biaxial compensation films.

10. The liquid crystal cell of claim 9, further comprising a C plate compensation films arranged between the liquid crystal cell and the biaxial compensation films.

11. The liquid crystal cell of claim 10, further comprising a C plate compensation films arranged between the liquid crystal cell and the biaxial compensation films.

12. The liquid crystal cell of claim 11, wherein the material layer of the biaxial compensation films is an optical dielectric material having a negative anisotropy.

13. The liquid crystal cell of claim 12, wherein d is about $6 \mu\text{m}$.

* * * * *

UNITED STATES PATENT AND TRADEMARK OFFICE
CERTIFICATE OF CORRECTION

PATENT NO. : 6,671,017 B2
DATED : December 30, 2003
INVENTOR(S) : Jae-Jin Lyu et al.

Page 1 of 1

It is certified that error appears in the above-identified patent and that said Letters Patent is hereby corrected as shown below:

Title page, Item [54] and Column 1, line 2,

Title, insert the word -- **USING** -- between the words "ANGLE" and "A".

Column 8,

Line 15, change "nx>fly>fly" to -- nx>ny>ny --.

Signed and Sealed this

Third Day of February, 2004

A handwritten signature in black ink that reads "Jon W. Dudas". The signature is written in a cursive style with a large, looping initial "J".

JON W. DUDAS

Acting Director of the United States Patent and Trademark Office

专利名称(译)	使用补偿膜的具有宽视角的液晶显示器		
公开(公告)号	US6671017	公开(公告)日	2003-12-30
申请号	US09/879119	申请日	2001-06-13
[标]申请(专利权)人(译)	LYU JAE 金 李沧HUN 常金学顺		
申请(专利权)人(译)	LYU JAE-JIN 李沧HUN 常HAK-SUN		
当前申请(专利权)人(译)	三星DISPLAY CO. , LTD.		
[标]发明人	LYU JAE JIN LEE CHANG HUN CHANG HAK SUN		
发明人	LYU, JAE-JIN LEE, CHANG-HUN CHANG, HAK-SUN		
IPC分类号	G02F1/139 G02F1/13 G02B5/30 G02F1/1335 G02F1/13363 G02F1/133		
CPC分类号	G02F1/133632 G02F1/1395 G02F2413/105		
优先权	1020000032506 2000-06-13 KR		
其他公开文献	US20030043325A1		
外部链接	Espacenet USPTO		

摘要(译)

本发明公开了一种液晶显示器，包括：液晶单元，包括一对透明基板；在其内表面上沉积有取向层；以及液晶材料的液晶层，注入在所述基板之间；设置在液晶单元的外表面上的双轴补偿膜，双轴补偿膜包括光学介电材料层；设置在双轴补偿膜的外表面上的偏振板，其中如果“d”被设定为液晶单元的单元间隙，则“RLC”被设定为液晶层的相位延迟值，垂直于由基板制成的平面设定为z轴，x轴和y轴形成在基板的平面表面上，并且包括在x，y和z方向上的双轴补偿膜的分子的折射率表示为通过 n_x ， n_y 和 n_z ，双轴补偿膜的延迟值 $(n_y - n_x) \cdot d$ 和 $(n_z - n_x) \cdot d$ 分别在 $-30 \pm 5 \text{nm}$ 和 $-RLC / 4 \pm 15 \text{nm}$ 的范围内。

