

(19)



(11)

EP 2 383 604 A1

(12)

EUROPEAN PATENT APPLICATION
published in accordance with Art. 153(4) EPC

(43) Date of publication:

02.11.2011 Bulletin 2011/44

(51) Int Cl.:

G02F 1/13363 (2006.01)

(21) Application number: **09839247.5**

(86) International application number:

PCT/JP2009/067660

(22) Date of filing: **09.10.2009**

(87) International publication number:

WO 2010/087058 (05.08.2010 Gazette 2010/31)

(84) Designated Contracting States:

**AT BE BG CH CY CZ DE DK EE ES FI FR GB GR
HR HU IE IS IT LI LT LU LV MC MK MT NL NO PL
PT RO SE SI SK SM TR**

(72) Inventor: **SAKAI, Akira**

Osaka 545-8522 (JP)

(30) Priority: **27.01.2009 JP 2009015927**

(74) Representative: **Müller - Hoffmann & Partner**

Patentanwälte

Innere Wiener Strasse 17

81667 München (DE)

(71) Applicant: **Sharp Kabushiki Kaisha**

Osaka-shi, Osaka 545-8522 (JP)

(54) **LIQUID CRYSTAL DISPLAY APPARATUS**

(57) The present invention provides a liquid crystal display device that has a higher contrast ratio in a wide viewing angle and that can be easily produced at low cost. The present invention is a liquid crystal display device, including in the following order:

a first polarizer;

a first quarter-wavelength plate ($n_x > n_y \geq n_z$);

a liquid crystal cell;

a second quarter-wavelength plate having an N_z coefficient substantially the same as that of the first quarter-wavelength plate;

a birefringent layer (II) ($n_x < n_y \leq n_z$); and

a second polarizer,

wherein

the first birefringent layer (I) has an in-plane slow axis forming an angle of about 45° with an absorption axis of the first polarizer;

the second birefringent layer (I) has an in-plane slow axis substantially orthogonal to the in-plane slow axis of the first birefringent layer (I);

the second polarizer has an absorption axis substantially orthogonal to the absorption axis of the first polarizer;

the birefringent layer (II) has an in-plane fast axis substantially orthogonal to the absorption axis of the second polarizer; and

the LC cell displays a black screen by aligning liquid crystal molecules in the liquid crystal layer substantially vertically to the substrate surface.

Fig. 12

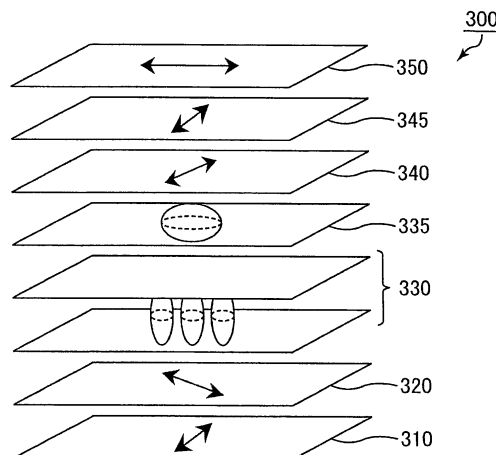

EP 2 383 604 A1

Description

TECHNICAL FIELD

5 **[0001]** The present invention relates to liquid crystal display (LCD) devices, and more particularly relates to circularly-polarizing plate-including VA (vertical alignment) LCD devices.

BACKGROUND ART

10 **[0002]** LCD devices are widely used as display devices for various data-processing devices such as computers and televisions. In particular, TFT LCD devices (hereinafter, also referred to as "TFT-LCD") become popular, and expansion of the TFT-LCD market is expected. Such a situation creates a demand for much improved image quality.

Although the present description employs the TFT-LCD as an example, the present invention may be applicable to general LCDs such as passive matrix LCDs and plasma address LCDs, in addition to the TFT-LCDs.

15 **[0003]** The most widely used mode in the TFT-LCDs currently is a mode in which a liquid crystal having positive dielectric anisotropy is horizontally aligned between parallel substrates, namely, the TN (twisted nematic) mode. In a TN LCD device, the alignment direction of LC molecules adjacent to one substrate is twisted by 90° to that of LC molecules adjacent to the other substrate. Such TN LCD devices are now produced at low cost and have been industrially mature, while they are less likely to achieve a higher contrast ratio.

20 **[0004]** In addition, there are known LCD devices having another mode in which a liquid crystal having negative dielectric anisotropy is aligned vertically to parallel substrates, namely the VA LCD devices. In the VA LCD devices, LC molecules are aligned almost vertically to the surfaces of the substrates when no voltage is applied. Here, the liquid crystal (LC) cell hardly shows birefringence and optical rotation, and light passes through the LC cell while hardly changing in its polarization state. Thus, in the case of the arrangement such that the LC cell is interposed between two polarizers
25 (linearly polarizers) absorption axes of which are orthogonal to each other (hereinafter, also referred to as cross-Nicol polarizers), it is possible to display an almost perfectly black screen when no voltage is applied. When a voltage not lower than a threshold voltage is applied (hereinafter, simply referred to as "the presence of an applied voltage"), the LC molecules are made to be almost parallel to the substrates, the LC cell shows large birefringence, and the LCD device displays a white screen. Thus, such a VA LCD device easily achieves a very high contrast ratio.

30 **[0005]** The VA LCD devices show asymmetric viewing angle characteristics when LC molecules are all aligned in the same direction in the presence of an applied voltage. In view of this, for example, MVA (multi-domain VA) LCD devices, which are one kind of the VA LCD devices, are now being widely used. According to the MVA LCD devices, the LC molecules in each pixel are aligned in multiple directions by a structurally-modified pixel electrode or an alignment control member such as a protrusion formed in a pixel.

35 **[0006]** The MVA LCD devices are so designed that an axial azimuth of a polarizer makes an angle of 45° with respect to an alignment azimuth of LC molecules in the presence of an applied voltage in order to maximize the transmittance in white display state. This is because the transmittance of a light beam passing through a birefringent medium interposed between the cross-Nicol polarizers is proportional to $\sin^2(2\alpha)$ where α (unit: rad) is an angle made by the axis of the polarizer and a slow axis of the birefringent medium. In typical MVA LCD devices, the LC molecules are aligned separately
40 in four domains, or at azimuths of 45°, 135°, 225°, and 315°. Also in the four-domain VA LCD devices, LC molecules are often aligned in Schlieren pattern or in undesired directions near at a domain boundary or near the alignment control member. This is one factor causing loss of transmittance.

[0007] In view of these circumstances, circularly-polarizing plate-including VA LCD devices are provided as disclosed in Patent Document 1, for example. According to the LCD device, the transmittance of a light beam passing through a
45 birefringent medium interposed between a right-circularly-polarizing plate and a left-circularly-polarizing plate orthogonal to each other is independent on an angle made by the axis of the polarizer and the slow axis of the birefringent medium. Therefore, a desired transmittance can be secured as long as the alignment of the LC molecules can be controlled, even if the alignment azimuth is not 45°, 135°, 225°, and 315°. Accordingly, a conical protrusion may be disposed at the center of a pixel, thereby aligning the LC molecules at every azimuth, or alternatively the LC molecules may be aligned
50 at random azimuths without any control of the alignment azimuth, for example. In the present description, the VA LCD devices including circularly-polarizing plates are referred to as CPVA LCD devices or CP LCD devices. In addition, VA LCD devices including linearly-polarizing plates are referred to as LPVA LCD devices or LP LCD devices. As is well known, the circularly-polarizing plate is typically composed of a combination with a linearly-polarizing plate or a quarter-wave plate.

55 **[0008]** The circularly-polarized light beam switches its handedness when being reflected on a mirror and the like, and so when it enters a left-handed circularly-polarizing plate disposed on a mirror, the light beam that has been converted into a left-handed circularly-polarized light beam by the polarizing plate is converted into a right-handed circularly-polarized light beam by being reflected by the mirror. The right-handed circularly-polarized light beam can not transmit

the left-handed circularly-polarizing plate. Thus, the circularly-polarizing plates are known to have an anti-reflection function. The anti-reflection function of the circularly-polarizing plates allows prevention of unnecessary reflection when display devices are viewed in bright environments such as outdoors. Therefore, the circularly-polarizing plate is known to have an effect of improving contrast ratio of display devices such as VA LCD devices in bright environments. The "unnecessary reflection" is considered to occur mainly due to transparent electrodes or metal wirings of TFT elements inside the display devices. If this unnecessary reflection occurs, even in a display device that can display an almost completely black screen in dark environments, the contrast ratio is lowered because the light amount in a black screen is increased under observation in bright environments.

[0009] As mentioned above, in CPVA LCD devices, the transmittance-improving effect and unnecessary reflection-preventing effect can be obtained, but common CPVA LCD devices have a low contrast ratio and can not show sufficient viewing angle characteristics as viewed from oblique directions. In this point, the CPVA LCD devices have room for improvement. In view of this, technologies involving use of birefringent layers (retardation films) for improving the viewing angle characteristics have been proposed. For example, Patent Document 1 discloses the following method (A); Patent Document 2 discloses the following method (B); Patent Document 3 discloses the following method (C); and Non-patent Document 1 discloses the following method (D).

(A) Use of two quarter-wave plates satisfying $n_x > n_y > n_z$

(B) Combination use of two quarter-wave plates satisfying $n_x > n_z > n_y$ and a birefringent layer (III) satisfying $n_x = n_y > n_z$

(C) Combination use of one or two half-wave plates satisfying $n_x > n_z > n_y$ in addition to the configuration (B)

(D) Combination use of two uniaxial quarter-wave plates

(so-called A plates satisfying $n_x > n_y = n_z$), a birefringent layer (III) satisfying $n_x = n_y > n_z$, and a birefringent layer satisfying $n_x > n_z > n_y$.

[Patent Document 1]

Japanese Kokai Publication No. 2002-40428

[Patent Document 2]

Japanese Kokai Publication No. 2003-207782

[Patent Document 3]

Japanese Kokai Publication No. 2003-186017

[Non-patent Document 1]

[0010] Zhibing Ge and six others, "Wide-View Circular Polarizers for Mobile Liquid Crystal Displays", IDRC08, 2008, p. 266-268

DISCLOSURE OF THE INVENTION

[0011] As a result of the inventor's studies, it was found that the methods (A) and (B) still have room for improvement in viewing angle characteristics. In addition, the methods (B), (C), and (D) involve use of biaxial retardation films satisfying $n_x > n_z > n_y$ ($0 < N_z < 1$), which are expensive and hard to produce. In this point, there is still room for improvement in the methods (B) to (D).

[0012] The present inventor made various investigations for solving the above-mentioned problems. The present inventor noted retardation conditions of birefringent layers disposed between a pair of polarizers (first and second polarizers) disposed in cross-Nicol. Then, the inventor found that the orthogonality between the first and second polarizers in oblique directions can be maintained while the orthogonality therebetween in the front direction is maintained when a birefringent layer (I) satisfying $n_x > n_y \geq n_z$ (satisfying $N_z \geq 1.0$) and a birefringent layer (II) satisfying $n_x < n_y \leq n_z$ (satisfying $N_z \leq 0.0$) are properly disposed between the first and second polarizers. Then, the inventor proposes the following method (E). Further, the inventor also found that unlike the biaxial retardation film satisfying $n_x > n_z > n_y$ ($0 < N_z < 1$), materials with appropriate intrinsic birefringence are used to produce the birefringent layers (I) and (II) easily. This was disclosed in Japanese Patent Application No. 2008-099526.

[0013]

(E) Combination use of two quarter-wave plates, a birefringent layer (III) satisfying $n_x = n_y > n_z$, a birefringent layer (I) satisfying $n_x > n_y \geq n_z$, and a birefringent layer (II) satisfying $n_x < n_y \leq n_z$.

[0014] However, as a result of the inventor's studies, it was found that the method (E) method is still insufficient in cost effectiveness because use of five or more birefringent layers (retardation films) is preferable. Further, in the method (E), the viewing angle characteristics are improved by setting Nz coefficients (parameter showing biaxiality) of the two quarter-wave plates to optimum values. However, it was found that the viewing angle characteristics still have room for improvement when two generalized biaxial quarter-wave plates satisfying $n_x > n_y \geq n_z$ ($N_z \geq 1.0$) are used.

[0015] The present invention is devised considering the aforementioned situations. An object of the present invention is to provide an LCD device that has a higher contrast ratio in a wide viewing angle and that can be easily produced at low cost.

[0016] The present inventor made various investigations on LCD devices that have a high contrast ratio in a wide viewing angle range and that can be easily produced at low cost, and noted retardation conditions of birefringent layers disposed between a pair of polarizers (first and second polarizers) disposed in cross-Nicol. Then, the inventors found that light leakage in a black state is decreased and a high contrast ratio can be provided in a wide viewing angle range when generalized biaxial quarter-wave plates satisfying $n_x > n_y \geq n_z$ (herein, "birefringent layer satisfying $n_x > n_y \geq n_z$ " is defined as a birefringent layer (I)) are used as two quarter-wave plates (first and second quarter-wave plates) and Nz coefficients thereof are adjusted to be almost the same, and further a birefringent layer satisfying $n_x < n_y \leq n_z$ (herein, "birefringent layer satisfying $n_x < n_y \leq n_z$ " is defined as a birefringent layer (II)) is disposed between the second quarter-wave plate and the second polarizer. Further, the inventor also found that unlike the biaxial retardation film satisfying $n_x > n_z > n_y$ ($0 < N_z < 1$), materials with appropriate intrinsic birefringence are used to produce the birefringent layers (I) and (II) easily. Thus, the present inventors have found the solution of the aforementioned problems and arrived at the present invention.

[0017] The present invention is a liquid crystal display device, including in the following order:

a first polarizer;

a first birefringent layer (I);

a liquid crystal cell including a liquid crystal layer interposed between a pair of substrates facing each other,

a second birefringent layer (I);

a birefringent layer (II); and

a second polarizer,

the first and second birefringent layers (I) each satisfying $n_x > n_y \geq n_z$, having an in-plane retardation of $\lambda/4$, and

having substantially the same Nz coefficient,

the birefringent layer (II) satisfying $n_x < n_y \leq n_z$,

wherein

the first birefringent layer (I) has an in-plane slow axis forming an angle of about 45° with an absorption axis of the first polarizer;

the second birefringent layer (I) has an in-plane slow axis substantially orthogonal to the in-plane slow axis of the first birefringent layer (I);

the second polarizer has an absorption axis substantially orthogonal to the absorption axis of the first polarizer;

the birefringent layer (II) has an in-plane fast axis substantially orthogonal to the absorption axis of the second polarizer; and

the LC cell displays a black screen by aligning liquid crystal molecules in the liquid crystal layer substantially vertically to the substrate surface.

[0018] The term "polarizer" herein represents an element which converts natural light into linearly polarized light and is synonymous with polarizing plate or polarizing film. The term "birefringent layer" herein represents a layer having optical anisotropy, and is synonymous with retardation film, retardation plate, optically anisotropic layer, birefringent medium, and the like. The term "birefringent layer" herein represents a layer one of magnitude of the below-mentioned in-plane retardation R and magnitude of the below-mentioned thickness-direction retardation Rth of which is 10 nm or larger, preferably 20 nm or larger. The term "birefringent layer (I)" herein represents one satisfying $n_x > n_y \geq n_z$. The term "birefringent layer (II)" herein represents one satisfying $n_x < n_y \leq n_z$. The "nx" and "ny" each represent the principal refractive index of a birefringent layer (including an LC cell or a quarter-wave plate) in the in-plane direction for a light beam at 550 nm. The "nz" represents the principal refractive index thereof in the out-of-plane direction for a light beam at 550 nm.

[0019] The term "in-plane retardation R" herein represents an in-plane retardation (unit: nm) defined by $R = |n_x - n_y| \times d$, where the principal refractive indices of a birefringent layer (including an LC cell or a quarter-wave plate) in the in-plane direction is n_x and n_y ; and the principal refractive index thereof in the out-of-plane direction (in the thickness direction) is n_z , and the thickness of the birefringent layer is defined as d. The term "thickness-direction retardation Rth" herein represents an out-of-plane (thickness-direction) retardation (unit: nm) defined by $R_{th} = (n_z - (n_x + n_y)/2) \times d$. The term "quarter-wave plate" herein represents an optically-anisotropic layer giving a retardation of about $1/4$ wavelength

(exactly 137.5 nm, but larger than 115 nm and smaller than 160 nm) at least to a light beam at 550 nm, and is synonymous with $\lambda/4$ retardation film or $\lambda/4$ retardation plate.

[0020] The term "in-plane slow axis (fast axis)" herein represents a direction (x-axis or y-axis direction) of dielectric axis corresponding to a principal refractive index n_s (n_f), where a larger one of the in-plane principal refractive indices n_x and n_y is redefined as n_s and a smaller one as n_f . The term "Nz coefficient" represents a parameter showing a degree of biaxiality of a birefringent layer, defined by $Nz = (n_s - n_z)/(n_s - n_f)$. The wavelength for the measurements of the principal refractive index, the retardation, and the like optical characteristics herein is 550 nm unless otherwise mentioned. Even in the case of birefringent layers each having the same Nz coefficient, difference in the average refractive indices $(n_x + n_y + n_z)/3$ of the birefringent layers causes difference in effective retardations of the birefringent layers to incident light from oblique directions due to refractive angles. Thus, the design principle becomes complicated. In order to avoid this problem, the average refractive index of each birefringent layer is herein standardized to 1.5 for Nz coefficient calculation, unless otherwise mentioned. For the birefringent layer having an actual average refractive index of not 1.5, the value is converted assuming that the average refractive index is 1.5. The below-mentioned thickness-direction retardation R_{th} is also standardized in the same manner.

[0021] In this description, when the first birefringent layer (I) and the second birefringent layer (I) have substantially the same Nz coefficient, a difference in the Nz coefficient is smaller than 1.0, preferably smaller than 0.05. Further, when the first birefringent layer (I) has an in-plane slow axis forming an angle of about 45° with an absorption axis of the first polarizer, the angle is 40° to 50° , particularly preferably 45° . Even if a relative angle formed by the in-plane slow axis of the first birefringent layer (I) and the absorption axis of the first polarizer is not just 45° , the effect of preventing light leakage in the normal direction of the substrate face can be sufficiently obtained because the in-plane slow axis of the first birefringent layer (I) is orthogonal to that of the second birefringent layer (I). Further, marked effects in anti-reflection or in transmittance improvement can be obtained when the above-mentioned relative angle is 45° . When the second birefringent layer (I) has an in-plane slow axis substantially orthogonal to the in-plane slow axis of the first birefringent layer (I), the angle made by the two in-plane slow axes is 88° to 92° , particularly preferably 90° . When the second polarizer has an absorption axis substantially orthogonal to the absorption axis of the first polarizer, the angle made by the two absorption axes is 88° to 92° , particularly preferably 90° . When the birefringent layer (II) has an in-plane fast axis substantially orthogonal to the absorption axis of the second polarizer, the angle made by the two axes is 88° to 92° , particularly preferably 90° .

[0022] The LCD device of the present invention may or may not other components as long as it essentially includes the first polarizer, the first birefringent layer (I), the LC cell, the second birefringent layer (I), the birefringent layer (II), and the second polarizer. In order to surely the below-mentioned conversion of the polarization state of a light beam used for display according to the present invention, preferable embodiments include one in which the LCD device does not include a birefringent layer between the first and second polarizers, other than the first polarizer, the first birefringent layer (I), the LC cell, the first birefringent layer (II), the birefringent layer (II), and the second polarizer. In order to lower production costs by reducing the number of the birefringent layers to be used in the LCD device, preferable embodiments include one in which the LCD device does not include a birefringent medium between the first and second polarizers, other than the first polarizer, the first birefringent layer (I), the LC cell, the second birefringent layer (I), the birefringent layer (II), and the second polarizer. However, the LCD device may include a birefringent medium other than the first polarizer, the first birefringent layer (I), the LC cell, the second birefringent layer (I), the birefringent layer (II), and the second polarizer.

For example, the LCD device may include a half-wave plate having an in-plane retardation of $\lambda/2$ for adjustment of wavelength dispersion of the birefringent layer and the like.

[0023] In addition, the inventor found that the factor of preventing a complete black screen varies depending on the azimuth, and also found that retardation compensation for multiple azimuths can be achieved by disposing a birefringent layer satisfying $n_x = n_y > n_z$ (herein, the "birefringent layer satisfying $n_x = n_y > n_z$ " is defined as a birefringent layer (III)) between the first and second quarter-wave plates. In the embodiment where the LCD device includes the birefringent layer (III), firstly a retardation of the birefringent layer (III) is adjusted, thereby optimizing conditions for retardation compensation at an azimuth of 0° , and secondly, the second birefringent layer is disposed to show a proper retardation, thereby optimizing conditions for retardation compensation at an azimuth of 45° without changing the optimum conditions for retardation compensation at an azimuth of 0° . As a result, light leakage in a black state in the oblique viewing direction can be prevented in a wider azimuth, whereby the LCD device can show a higher contrast ratio in viewing angle directions with large azimuth and polar angle. Further, unlike the biaxial retardation film satisfying $n_x > n_z > n_y$ ($0 < Nz < 1$), materials with appropriate intrinsic birefringence are used to produce the birefringent layer (III) easily. The term "azimuth" herein means a direction in the plane parallel to the substrate surface of the LC cell and is represented by 0° to 360° .

The term "polar angle" herein means a tilt angle with respect to the normal direction of the substrate surface of the LC cell. **[0024]** The LCD device of the present invention may have an embodiment where the device further includes at least one birefringent layer (III) satisfying $n_x \approx n_y \geq n_z$ between the first birefringent layer (I) and the liquid crystal cell and/or between the liquid crystal cell and the second birefringent layer (I). The birefringent layer (III) can be particularly preferably

employed when the N_z coefficients of the first and second birefringent layers (I) are each less than 2.00. The birefringent layer (III) is preferably disposed adjacent to the LC cell. The phrase "disposed adjacent to" herein means that no birefringent medium is disposed between the LC cell and the birefringent layer (III). In one embodiment, for example, an isotropic film may be disposed between the birefringent layer (III) and the LC cell. If a plurality of the birefringent layers (III) is disposed, at least one of the birefringent layers (III) is disposed adjacent to the LC cell, and the respective birefringent layers (III) are disposed adjacent to one another.

[0025] The $n_x \approx n_y$ in the birefringent layer (III) is, in other words, $|n_x - n_y| \approx 0$, and specifically represents the case where an in-plane retardation $R = |n_x - n_y| \times d$ is smaller than 20 nm, preferably smaller than 10 nm. The birefringent layer (III) may have a multi-layer or single-layer structure. Regardless of the number of layers constituting the birefringent layer (III), the characteristics of the transmissive light intensity of the LCD device are completely the same in principle as long as the birefringent layer (III) is disposed on the inside (the LC cell side) of the first and second quarter-wave plates and the total thickness-direction retardation of the birefringent layer (III) is fixed. There are no any problems in principle that the LCD device is assumed to include a birefringent layer (III) having a thickness-direction retardation of zero even when it actually includes no birefringent layer (III). Accordingly, in this description, the present invention is simply mentioned with reference to only LCD device including one birefringent layer (III) between the second quarter-wave plate and the LC cell unless otherwise specified.

[0026] Typically, a PVA (polyvinyl alcohol) film with a dichroic anisotropic material such as an iodine complex adsorbed and aligned thereon may be employed as the polarizer. Usually, a protective film such as a triacetyl cellulose (TAC) film is laminated on the respective sides of the PVA film to secure mechanical strength, moisture resistance, heat resistance, and the like, and the resulting laminated film is practically used. Unless otherwise specified, the term "polarizer" herein means the element with the polarization function alone, not including the protective films. The first and second polarizers are so designed that one constitutes a polarizer (a back-side polarizer) and the other constitutes an analyzer (a viewing-side polarizer), and regardless of which of the polarizer and the analyzer the first or second polarizer constitutes, the characteristics of the transmissive light intensity of the LCD device is not changed at all in principle. Unless otherwise specified, the present invention is simply mentioned with reference to only an LCD device including the first polarizer as a polarizer.

[0027] The LC cell includes a pair of substrates and an LC layer therebetween. The LC cell of the present invention is in a VA (vertical alignment) mode where a black screen is displayed by aligning LC molecules in the LC cell substantially vertically to the substrate plane. The VA mode includes MVA (multi-domain VA) mode, CPA (continuous pinwheel alignment) mode, PVA (patterned VA) mode, BVA (biased vertical alignment), and Reverse TN mode, IPS-VA (in-plane switching-VA) mode, and the like. When the LC molecules are aligned substantially vertically to the substrate plane, the average pretilt angle of the LC molecules is 80° or larger.

[0028] The LCD device of the present invention includes, between the first and second polarizers, the first birefringent layer (I) having an in-plane retardation of $\lambda/4$ (first quarter-wave plate) and the second birefringent layer (I) having an in-plane retardation of $\lambda/4$ (second quarter-wave plate), and the birefringent layer (II). In the present invention, as mentioned above, the LCD device may further include the birefringent layer (III) between the first and second polarizers. For example, a combination of the second quarter-wave plate and the second birefringent layer, a combination of the second quarter-wave plate and the birefringent layer (III), and a combination of the first quarter-wave plate and the birefringent layer (III) are each preferably a multi-layer body composed of these layers without a cohesive agent therebetween. Such a multi-layer body can be prepared by attaching films prepared by coextrusion and the like with an adhesive agent or by forming one birefringent layer constituting the multi-layer body from a polymer film, and thereon coating or transferring the other birefringent layer including a liquid crystalline material or a non-liquid crystalline material. The latter method involving coating or transferring is preferably employed when the birefringent layer (III), which is often formed by coating a non-crystalline material such as polyimide or a liquid crystalline material such as a cholesteric liquid crystal, is stacked on the second quarter-wave plate or the first quarter-wave plate.

[0029] A light beam that has entered the first polarizer from the front direction is converted into a linearly-polarized light beam by the first polarizer and then passes through the first quarter-wave plate, thereby being converted into a circularly-polarized light beam and passes through the LC cell and the birefringent layer (III), maintaining its polarization state. Then, when passing through the second quarter-wave plate orthogonal to the first quarter-wave plate, the circularly-polarized light beam is converted again into a linearly-polarized light beam similarly to that just after passing through the first polarizer and passes through the birefringent layer (II), maintaining its polarization state, and finally, the linearly-polarized light beam is blocked by the second polarizer orthogonal to the first polarizer. Thus, the birefringent layers (II) and (III) are not meant to give a retardation to an incident light beam from the front direction.

[0030] The above description relates to the case where the black screen is displayed by tracing the change of the polarization state at the output of the respective layers, and it can be intuitively understood as follows. Specifically, the LCD device of the present invention including the cross-Nicol polarizers can display a completely black screen in the front direction because of the following optical compensations (1) to (4):

(1) the first and second quarter-wave plates are disposed to be orthogonal to each other between the first and second

polarizers, and the retardations thereof are the same ($\lambda/4$) and so the retardation can be canceled. Thus, the first and second quarter-wave plates are disabled; (2) the birefringent layer (II) disposed between the first and second polarizers has a fast axis orthogonal to the absorption axis of the second polarizer. Thus, the birefringent layer (II) is substantially disabled; (3) the birefringent layer (III) and the LC cell disposed between the first and second polarizers each have a retardation of zero in the front direction, and so they are substantially disabled; and (4) the first and second polarizers are disposed to be orthogonal to each other, so-called cross-Nicole polarizers.

[0031] The LCD device of the present invention can not display a completely black screen in the oblique direction because a light beam incident from an oblique direction to the first polarizer is not blocked by the second polarizer because of the following three reasons assuming that no conversion of the polarization state attributed to the birefringent layers (II) and (III) is given. Specifically, the birefringent layers (II) and (III) are meant to give a conversion of the polarization state only to a light beam incident from the oblique direction, thereby compensating the viewing angle characteristics.

[0032] As mentioned above, the birefringent layers (II) and (III) of the present invention can display an excellent black screen also in the oblique direction while maintaining an excellent black state in the front direction. Therefore, the LCD device can show a higher contrast ratio in the oblique direction to provide excellent viewing angle characteristics.

[0033] Below mentioned are the three reasons why the viewing angle compensation is provided by converting the polymerization state of a light beam incident from an oblique direction by the birefringent layers (II) and (III). This is mentioned with reference to a CPVA LCD device 100 including, as shown in Fig. 1, a first polarizer 110 (absorption axis azimuth of 90°), a first quarter-wave plate 120 (slow axis azimuth of 135°), a VA LC cell 130, a second quarter-wave plate 140 (slow axis azimuth of 45°), a second polarizer 150 (absorption axis azimuth of 0°), and not including the birefringent layers (II) and (III). In Fig. 1, the arrow shown in each of the first and second polarizers 110 and 150 represents an azimuth of the absorption axis thereof, and the arrow shown in each of the first and second quarter-wave plates 120 and 140 represents an azimuth of the slow axis thereof. The ellipsoidal body illustrated in the VA LC cell 130 shows the shape of the refractive index ellipsoidal body of the cell 130.

[0034] First, with respect to a black screen in the front direction, a light beam that has entered the first polarizer 110 from the front direction is converted into a linearly-polarized light beam by the first polarizer 110 and then further converted into a circularly-polarized light by the first quarter-wave plate 120, and then passes through the LC cell 130, maintaining its polarization state. Then when passing through the second quarter-wave plate 140 orthogonal to the first quarter-wave plate 120, the circularly-polarized light beam is reconverted into the same linearly-polarized light beam as just at the output of the first polarizer 110, and finally, the linearly-polarized light beam is blocked by the second polarizer 150. Thus, an excellent black screen is displayed. In other words, the LCD device 100 can display a completely black screen in the front direction because (1) the first and second quarter-wave plates 120 and 140 are disposed to be orthogonal to each other between the first and second polarizers 110 and 150, and the retardations thereof are the same ($\lambda/4$) and so the retardation can be canceled.

Thus, the first and second quarter-wave plates are disabled; (2) the LC cell 130 disposed between the first and second polarizers 110 and 150 has a retardation of zero in the front direction, and so it is substantially disabled; and (3) the first and second polarizers 110 and 150 are disposed to be orthogonal to each other, so-called cross-Nicole polarizers.

[0035] Then, with respect to a black screen in an oblique direction, a completely perfect black screen can not be displayed because of the following factors (1) to (3) contributing to reduction in viewing angle:

- (1) the first and second quarter-wave plate 120 and 140 are not orthogonal to each other or have different retardations. Thus the first and second quarter-wave plate 120 and 140 are enabled;
- (2) the LC cell 130 does not has a retardation of zero and so is not disabled; and
- (3) the first and second polarizers 110 and 150 are not disposed to be orthogonal to each other, and so the cross-Nicole polarizers are not present.

[0036] The factors (1) to (3) are mentioned in more detail below with reference to Fig. 2. Although in the front direction (the normal direction to the substrate surface), the slow axis 121 of the first quarter-wave plate 120 and the slow axis 141 of the second quarter-wave plate 140 are orthogonal to each other as schematically shown in Fig. 2(a), they are not orthogonal to each other in an oblique direction with an azimuth of 0° . Thus the retardation is not canceled and so the first and second quarter-wave plates 120 and 140 are not disabled. Further, in the front direction, the slow axis 121 of the first quarter-wave plate 120 and the slow axis 141 of the second quarter-wave plate 140 are orthogonal to each other as schematically shown in Fig. 2(b), and meanwhile, in an oblique direction with an azimuth of 45° , they are orthogonal to each other but the retardations of the first and second quarter-wave plates 120 and 140 are not the same. Thus, the retardation is not cancelled. This is because the retardation is determined by birefringence (refractive index difference) \times thickness and effective birefringence is different between in the front direction and in the oblique direction and further varies depending on the azimuth. From the same reason, the retardation of the VA LC cell 130 is zero in the front direction, but not zero in any oblique direction. Only in the front direction, both of the effective birefringence and the retardation are zero. As schematically shown in Fig. 2(c), although in the front direction, the absorption axis 111

of the first polarizer 110 and the absorption axis 151 of the second polarizer 150 are orthogonal to each other, they are not orthogonal to each other in an oblique direction with an azimuth of 45°.

[0037] As mentioned above, the CPVA LCD device 100 having the simplest configuration can not display a perfect black screen in the oblique directions because of the three factors (1) to (3). Conversely, elimination of these factors, i.e., providing optical compensation allows display of a black screen in the oblique directions. The aforementioned technologies (A) to (E) for viewing angle improvement actually involve the optical compensation for the factors. In addition, the factors (1) and (2) are usually observed together. Accordingly, the optical compensations for the respective factors (1) and (2) may be performed not separately but together.

[0038] The CPVA LCD device is so designed to provide optical compensations for the factors (1) to (3) simultaneously based on the following design principle. Specifically, the device is so designed that a generalized biaxial quarter-wave plate (the birefringent layer (I)) satisfying $n_x > n_y \geq n_z$ is used as the first and second quarter-wave plates and the N_z coefficients thereof are adjusted to be almost the same, and a birefringent layer (the birefringent layer (II)) satisfying $n_x < n_y \leq n_z$ is disposed between the second quarter-wave plate and the second polarizer, and further, if necessary, a birefringent layer (the birefringent layer (III)) satisfying $n_x = n_y > n_z$ is disposed between the first and second quarter-wave plates.

[0039] The following will mention the design principle of the birefringent layers of the present invention. The present inventor made various investigations on simple and effective optical compensations for the above-mentioned factors, and noted on a difference in needs for optical compensation depending on the azimuth. Then, the inventor found that as shown in the following Table 1, the optical compensation of the polarizers for the factor (3) is unnecessary, and that only the optical compensation of the quarter-wave plates for the factor (1) and that of the LC cell for the factor (2) suffice for the optical compensation.

[0040]

[Table 1]

Azimuth	Need of optical compensation		
	(1) Quarter-wave plate	(2) LC cell	(3) Polarizer
0°	need	need	not need
45°	need	need	need

[0041] As a result, the inventor found that the factors (1) and (2) in the oblique view direction with an azimuth of 0° are simultaneously and effectively eliminated by optimizing N_z coefficients N_{zq} of the first and second quarter-wave plates and a thickness-direction retardation R_{lc} of the LC cell based on polarization state representation on the Poincare sphere and computer simulations, and further if necessary, by disposing the birefringent layer (III) satisfying $n_x = n_y > n_z$ between the first and second quarter-wave plates and optimizing the thickness-direction retardation R_3 thereof. In this description, the 1st step means this process where the N_z coefficients N_{zq} of the first and second quarter-wave plates, the thickness-direction retardation R_{lc} of the LC cell, the thickness-direction retardation R_3 of the birefringent layer (III) are optimized for optical compensation at an azimuth of 0°.

[0042] The inventor also found that the factors (1), (2), and (3) are simultaneously and effectively eliminated in an oblique direction with an azimuth of 45° by, after the 1st step, disposing the birefringent layer (II) satisfying $n_x < n_y \leq n_z$ between the second quarter-wave plate and the second polarizer to have an in-plane fast axis substantially orthogonal to the absorption axis of the second polarizer, and optimizing an N_z coefficient N_{z2} and an in-plane retardation R_2 of the birefringent layer (II). In this description, the 2nd step means this process following the 1st step, where the N_z coefficient N_{z2} and the in-plane retardation R_2 of the birefringent layer (II) are optimized for optical compensation at an azimuth 45°.

[0043] The in-plane fast axis of the birefringent layer (II), which is additionally disposed in the 2nd step, is substantially orthogonal to the absorption axis of the adjacent second polarizer, and so the optical characteristics at the absorption axis azimuth of the second polarizer, i.e., in a direction with an azimuth of 0° are not changed at all. Thus, the optical compensation of the present invention is **characterized in that** the optimum state achieved in the 1st step can be maintained also after the 2nd step. This optical compensation way where the 1st and 2nd steps are completely independent from each other simplifies the design of the birefringent layers.

[0044] The following will mention the details of the optical compensation principle in each of the 1st and 2nd steps with reference to the Poincare sphere. The Poincare sphere is widely known in crystal optics as a useful approach for tracing of state of polarization of light propagating through a birefringent layer (for example, see "Kessyo Kogaku", written by Takasaki Hiroshi, published by Morikita Publishing Co., Ltd., 1975, p. 146 to 163).

[0045] On the Poincare sphere, right-handed polarized state is represented on the upper hemisphere; left-handed

polarized state on the lower hemisphere, linear polarized state on the equator; right- and left-handed circular polarized states are on upper and lower poles, respectively. Between two polarization states symmetrical with respect to the coordinate origin of the sphere, the ellipticity angles are the same in magnitude but opposite in polarity. This shows that the two polarization states are in the orthogonal polarization state.

5 [0046] The effects attributed to the birefringent layer are shown on the Poincare sphere as follows. The point showing state of polarization of a light beam before propagating through a birefringent layer is rotated in a counterclockwise direction by an angle determined by $(2\pi) \times (\text{retardation})/(\text{wavelength})$ (unit: rad) around the slow axis (specifically, the point showing slower one of the two eigenmodes of vibration of a birefringent layer) (this is the same when the point is rotated in a clockwise direction around the fast axis).

10 [0047] The rotation center and the rotation angle in an oblique view direction are determined by the slow axis (or the fast axis) and the retardation at the viewing angle. Although not being explained in detail, these can be calculated, for example, by determining a vibrating direction in the eigenmode of vibration and a wave vector in the birefringent layer from Fresnel equation for the normal incidence. The slow axis in oblique view directions depends on a viewing angle, an Nz coefficient, and an in-plane retardation R (or a thickness-direction retardation Rth).

15 (Compensation principle in the 1st step)

[0048] First, the polarization state when the CPVA LCD device 100 in Fig. 1 is viewed from the front direction is mentioned. Fig. 3 is a view showing changes in the polarization state of a light beam emitted from a backlight (not shown in Fig. 1, but located below the first polarizer) under this condition, represented on S1-S2 plane of the Poincare sphere. The points in Fig. 3 show the respective polarization states at the output of the respective polarizers 110 and 150, the respective birefringent layers 120 and 140, and the LC cell 130. The points showing the respective polarization states are actually on the Poincare sphere but projected on S1-S2 plane. The point showing the polarization state is shown by "○" and the point showing the slow (fast) axis of the birefringent layer is shown by "×".

25 [0049] The polarization state of the light beam just at the output of the first polarizer 110 is represented by P0 on the Poincare sphere, and P0 corresponds to E showing a polarization state the second polarizer 150 can absorb, i.e., extinction position (absorption axis azimuth) of the second polarizer 150. Then, when the light beam passes through the first quarter-wave plate 120, P0 is moved to P1 by rotation by a specific angle around the slow axis of the first quarter-wave plate 120 represented by Q1 on the Poincare sphere. The rotation is in a counterclockwise direction when the coordinate origin O is viewed from Q1.

30 [0050] Successively, the light beam passes through the VA LC cell 130 but does not change in its polarization state because the cell 130 has a retardation of zero in the front direction. Finally, the light beam passes through the second quarter-wave plate 140, and P1 is moved to P2 by rotation by a specific angle around the slow axis of the second quarter-wave plate 140 represented by Q2. This P2 corresponds to extinction position E of the second polarizer 150. Thus, the LCD device 100 of Fig. 1 can block the light beam from the backlight to display an excellent black screen when viewed from the front direction.

35 [0051] The following will mention the polarization state when the CPVA LCD device 100 of Fig. 1 is viewed from a direction with the absorption axis azimuth 0° of the second polarizer 150 and the direction inclined by an angle of 60° inclined from the normal direction (hereinafter, also referred to as a polar angle of 60°). Fig. 4 is a view showing changes in the polarization state of a light beam emitted from a backlight under this condition, represented on S1-S2 plane of the Poincare sphere. The points in Fig. 4 show the respective polarization states at the output of the respective polarizers 110 and 150, the respective birefringent layers 120 and 140, and the LC cell 130.

40 [0052] The polarization state of the light beam just at the output of the first polarizer 110 is represented by P0 on the Poincare sphere and P0 corresponds to E showing a polarization state the second polarizer 150 can absorb, i.e., extinction position (absorption axis azimuth) of the second polarizer 150. Then, when the light beam passes through the first quarter-wave plate 120, P0 is moved to P1 by rotation by a specific angle around the slow axis of the first quarter-wave plate 120 represented by Q1 on the Poincare sphere. The rotation is in a counterclockwise direction when the coordinate origin O is viewed from Q1.

45 [0053] Successively, the light beam passes through the VA LC cell 130, and P1 reaches P2 by rotation by a specific angle around the slow axis of the LC cell 130 represented by L on the Poincare sphere. The rotation is in the counterclockwise direction when the coordinate origin O is viewed from L. Finally, the light beam passes through the second quarter-wave plate 140, and P2 is moved to P3 by rotation by a specific angle around the slow axis of the second quarter-wave plate 140 represented by Q2. This P3 does not correspond to extinction position E of the second polarizer 150. Thus, the LCD device 100 of Fig. 1 can not block the light beam from the backlight when viewed from the direction with an azimuth of 0° and a polar angle of 60° .

50 [0054] The positions of P1 to P3 in Figs. 3 and 4 depend on the Nz coefficients Nzq of the first and second quarter-wave plates 120 and 140 and the thickness-direction retardation Rlc of the LC cell 130. Figs. 3 and 4 show, as an example, the embodiment where Nzq = 1.6 and Rlc = 320 nm are satisfied. For simply showing the conversion of the

polarization state, the positions of the respective points are roughly shown and might not be accurate. For ease illustration, the arrows showing tracing from P1 to P3 are not shown. The retardation R_{lc} of the VA LC cell 130 is typically about 320 nm, and usually adjusted to a value ranging from 270 nm to 400 nm. For example, the retardation R_{lc} is required to be larger than 320 nm in order to increase the transmittance. The Nz coefficient N_{zq} of each of the first and second quarter-wave plates is usually adjusted to a value ranging from 1.0 to 2.9. For example, in the case where a VA LC cell having a retardation R_{lc} of about 400 nm and the birefringent layer (III) is not disposed, quarter-wave plates satisfying $N_{zq} = 2.9$ are preferably used.

[0055] The following will mention a CPVA LCD device 200 including the birefringent layer (III) as shown in Fig. 5, and having a multi-layer structure composed of a first polarizer 210 (absorption axis azimuth angle of 90°), a first quarter-wave plate 220 (slow axis azimuth angle of 135°), a VA LC cell 230, a birefringent layer (III) 235, a second quarter-wave plate 240 (slow axis azimuth angle of 45°), and a second polarizer 250 (absorption axis azimuth angle of 0°). In Fig. 5, the arrow shown in each of the first and second polarizers 210 and 250 represents an azimuth of the absorption axis thereof, and the arrow shown in each of the first and second quarter-wave plates 220 and 240 represents an azimuth of the slow axis thereof. The ellipsoidal bodies in the VA LC cell 230 and the birefringent layer (III) 235 show the shape of the respective refractive index ellipsoidal bodies thereof.

[0056] First, the polarization state when the CPVA LCD device 200 in Fig. 5 is viewed from the front direction. Fig. 6 is a view showing changes in the polarization state of a light beam emitted from a backlight (not shown in Fig. 5, but located below the first polarizer 210) under this condition, represented on S1-S2 plane of the Poincare sphere. The points in Fig. 6 show the respective polarization states at the output of the respective polarizers 210 and 250, the respective birefringent layers 220 and 240, and the LC cell 230.

[0057] The polarization state of the light beam just at the output of the first polarizer 210 is represented by P0 on the Poincare sphere, and P0 corresponds to E showing a polarization state the second polarizer 250 can absorb, i.e., extinction position (absorption axis azimuth) of the second polarizer 250. Then, when the light beam passes through the first quarter-wave plate 220, P0 is moved to P1 by rotation by a specific angle around the slow axis of the first quarter-wave plate 220 represented by Q1 on the Poincare sphere. The rotation is in a counterclockwise direction when the coordinate origin O is viewed from Q1.

[0058] Successively, the light beam passes through the VA LC cell 230 and the birefringent layer (III) 235 but does not change in its polarization state because the cell 230 and the birefringent layer (III) 235 each have a retardation of zero in the front direction. Finally, the light beam passes through the second quarter-wave plate 240, and P1 is moved to P2 by rotation by a specific angle around the slow axis of the second quarter-wave plate 240 represented by Q2. This P2 corresponds to extinction position E of the second polarizer 250. Thus, the LCD device 200 of Fig. 5 can block the light beam from the backlight to display an excellent black screen when viewed from the front direction, as in the LCD device 100 in Fig. 1.

[0059] The following will mention the polarization state when the CPVA LCD device 200 of Fig. 5 is viewed from a direction with the absorption axis azimuth 0° of the second polarizer 210 and with a polar angle of 60° from the normal direction. Fig. 7 is a view showing changes in the polarization state of a light beam emitted from a backlight under this condition, represented on S1-S2 plane of the Poincare sphere. The points in Fig. 7 show the respective polarization states at the output of the respective polarizers 210 and 250, the respective birefringent layers 220 and 240, and the LC cell 230.

[0060] The polarization state of the light beam just at the output of the first polarizer 210 is represented by P0 on the Poincare sphere and P0 corresponds to extinction position (absorption axis azimuth) of the second polarizer 250. Then, when the light beam passes through the first quarter-wave plate 220, P0 reaches P1 by rotation by a specific angle around the slow axis of the first quarter-wave plate 220 represented by Q1 on the Poincare sphere. The rotation is in a counterclockwise direction when the coordinate origin O is viewed from Q1.

[0061] Successively, the light beam passes through the VA LC cell 230, and P1 reaches P2 by rotation by a specific angle around the slow axis of the LC cell 230 represented by L on the Poincare sphere. The rotation is in a counterclockwise direction when the coordinate origin O is viewed from L. Then, the light beam passes through the birefringent layer (III) 235, and P1 reaches P3 by rotation by a specific angle around the slow axis of the birefringent layer (III) 235, represented by R3 on the Poincare sphere. The rotation is in the counterclockwise direction when the coordinate origin O is viewed from R3. Finally, the light beam passes through the second quarter-wave plate 240, and P3 is moved to P4 by rotation by a specific angle around the slow axis of the second quarter-wave plate 240 represented by Q2. This P4 corresponds to extinction position E of the second polarizer 250. Thus, the LCD device 200 of Fig. 5 can not block the light beam from the backlight when viewed from the direction with an azimuth angle of 0° and a polar angle of 60° , as in viewing from the front direction.

[0062] The positions of P1 to P4 in Figs. 6 and 7 depend on the Nz coefficients N_{zq} of the first and second quarter-wave plates 220 and 240 and the thickness-direction retardation R_{lc} of the LC cell 230. Figs. 6 and 7 show, as an example, the embodiment where $N_{zq} = 1.6$, $R_{lc} = 320$ nm, and $R_3 = -129$ nm are satisfied. For simply showing the conversion of the polarization state, the positions of the respective points are roughly shown and might not be accurate.

For ease of illustration, the arrows showing tracing from P1 to P4 are not shown.

[0063] As a result of the studies, the inventor found that the optimum retardation value R3 of the birefringent layer 235 (III) varies according to the Nz coefficients Nzq of each of the first and second quarter-wave plates 220 and 240. Figs. 8 and 9 are views each showing changes in the polarization state when the circular polarization VA LCD device 200 in Fig. 5 is viewed from a direction with the absorption axis azimuth 0° of the second polarizer 250 and a polar angle of 60°, represented on S1-S2 plane of the Poincare sphere. Fig. 8 shows the embodiment where Nzq = 2.0, Rlc = 320 nm, and R3 = -61 nm are satisfied. Fig. 9 shows the embodiment where Nzq = 2.35, Rlc = 320 nm, and R3 = 0 nm are satisfied.

[0064] As shown in Figs. 7, 8, and 9, the larger the Nz coefficient Nzq of each of the first and second quarter-wave plates 220 and 240 becomes the more symmetrical with respect to S1 axis P1 showing the polarization state just at the output of the first quarter-wave plate 220 and P2 showing the polarization state just at the output of the VA LC cell 230 become. As a result, the P2-P3 conversion magnitude required for P4 and E to correspond to each other, specifically, the magnitude of the required retardation R3 of the birefringent layer (III) 235 becomes smaller. As mentioned above, the retardation Rlc of the VA LC cell 230 is adjusted to a value ranging from 270 nm to 400 nm, and so if the Nz coefficient Nzq of each of the first and second quarter-wave plates 220 and 240 is larger than 2.00, the required retardation R3 of the birefringent layer (III) 235 is substantially zero. That is, no birefringent layer (III) 235 is needed. When the retardation Rlc is 320 nm, which is a retardation value in a typical VA LC cell, and when Nzq = 2.35 is satisfied, the required retardation R3 of the birefringent layer (III) is substantially zero.

[0065] Table 2 and Fig. 10 show a relationship between the Nz coefficients Nzq of each of the first and second quarter-wave plates 220 and 240 and the optimum thickness-direction retardation R3 of the birefringent layer (III) 235, based on the results determined by computer simulations. In the Poincare sphere diagram in Figs. 7 to 9, the polarization conversion from P1 to P3 is illustrated separately into P1 to P2 conversion attributed to the thickness-direction retardation Rlc of the VA LC cell 230 and into P2 to P3 conversion attributed to the thickness-direction retardation R3 of the birefringent layer (III) 235. However, these two conversions are the same in rotation center, juts opposite in rotation direction. The rotation direction is determined by a plus and minus sign of the thickness-direction retardation. The rotation angle is determined by the magnitude of the thickness-direction retardation. Accordingly, the above-mentioned two conversions can be regarded as a direct conversion P1 to P3 attributed to "the total thickness-direction retardation Rlc + R3" of the "VA LC cell 230 + the birefringent layer (III) 235". In other words, two LCDs having the same value of Rlc + R3 have the same optical characteristics regardless of the thickness-direction retardation Rlc of the VA LC cell 230. Table 2 shows the optimum values Rlc + R3 calculated by computer simulations. As shown in Table 2 and Fig. 10, with respect to the relationship between Nzq and the optimum Rlc + R3, the following (A) gives a sufficiently close approximate value in the case of 1.0 ≤ Nz ≤ 2.9.

$$Rlc + R3 = 169 \text{ nm} \times Nzq - 81 \text{ nm} \quad (A)$$

[0066] In order to provide LC display with a high contrast ratio in a wide viewing angle, the retardation Rlc + R3, which is a sum of the thickness-direction retardation Rlc in a black state (in the absence of an applied voltage to the LC layer) of the VA LC cell 230 and the thickness-direction retardation R3 of the birefringent layer (III) 235 is most preferably the optimum value shown in Table 2 and Fig. 10. However, the value may slightly deviate from the optimum value unless the contrast ratio in oblique directions is significantly reduced. For sufficient advantageous effects of the invention, it is preferable that the retardation Rlc + R3 is within the optimum value ± 30 nm.

[0067]

[Table 2]

Nzq	Rlc+R3 (nm)
1. 00	88
1. 10	105
1. 20	122
1. 30	140
1. 40	157
1. 50	174
1. 60	191

(continued)

Nzq	Rlc+R3 (nm)
1. 70	208
2. 00	259
2. 30	309
2. 40	325
2. 50	342
2. 90	406

(Compensation principle in the 2nd step)

[0068] Below mentioned is the case where the LCD device 200 of Fig. 5 after the 1st step is viewed from a direction with an azimuth angle (hereinafter, also referred to as an "azimuth angle of 45°") bisecting the absorption axis azimuth angle of 90° of the first polarizer 210 and the absorption axis azimuth angle of 0° of the second polarizer 230 and the direction inclined by 60°. As mentioned above, in the LCD device 200, the optical compensation at an azimuth angle of 0° has been achieved by determining the optimum values each of thickness-direction retardation R3 of the birefringent layer (III) 235 and the thickness-direction retardation Rlc of the LC cell 230 in accordance with the Nz coefficient Nzq of each of the first and second $\lambda/4$ retarders 220 and 240. Fig. 11 is a view showing changes in the polarization state of a light beam emitted from a backlight under this condition, represented on S1-S2 plane of the Poincare sphere. The points in Fig. 11 show the respective polarization states at the output of the respective polarizers 210 and 250, the respective birefringent layers 220 and 240, and the LC cell 230.

[0069] The polarization state just at the output of the first polarizer 210 is represented by P0 on the Poincare sphere, which does not correspond to the polarization state the second polarizer 250 can absorb, i.e., extinction position (absorption axis azimuth) of the second polarizer 250. This shows that optical compensation is required when the LCD device 200 is viewed from the oblique direction with an azimuth angle of 45° because in this oblique direction, the first and second polarizers 210 and 250 are not orthogonal to each other. When the light beam passes through the first quarter-wave plate 220, P0 is moved to P1 by rotation by a specific angle around the slow axis of the first quarter-wave plate 220 represented by Q1 on the Poincare sphere. The rotation is in a counterclockwise direction when the coordinate origin O is viewed from Q1.

[0070] Successively, the light beam passes through the VA LC cell 230, and P1 is moved to P2 by rotation by a specific angle around the slow axis of the LC cell 230 represented by L on the Poincare sphere. This rotation is in a counterclockwise direction when the coordinate origin O is viewed from L. Then the light beam passes through the birefringent layer (III), and P2 reaches P3 by rotation by a specific angle around the slow axis of the birefringent layer (III) 235 represented by R3 on the Poincare sphere. The rotation is in a counterclockwise direction when the coordinate origin O is viewed from R3. Finally, the light beam passes through the second quarter-wave plate 240, and P3 is moved to P4 by rotation by a specific angle around the slow axis of the second quarter-wave plate 240 represented by Q2. This P4 does not correspond to extinction position E of the second polarizer 250. Thus, the LCD device 200 of Fig. 5 can not block the light beam from the backlight when viewed from the oblique direction with an azimuth angle of 45° and a polar angle of 60°. Specifically, the optical compensation is not achieved when the LCD device 200 just having undergone the 1st step is viewed from the oblique direction with an azimuth angle of 45°.

[0071] The positions of P1 to P4 in Fig. 11 depend on the Nz coefficient Nzq of each of the first and second quarter-wave plates 220 and 240, the thickness-direction retardation Rlc of the LC cell 230, and the thickness-direction retardation R3 of the birefringent layer (III) 235. Fig. 11 shows, as an example, the embodiment where Nzq = 1.6, Rlc = 320 nm, and R3 = -129 nm are satisfied. For simply showing the conversion of the polarization state, the positions of the respective points are roughly shown and might not be accurate. For ease of illustration, the arrows showing tracing from P1 to P4 are not shown.

[0072] The following will mention a CPVA LCD device 300 including the birefringent layer (II) as shown in Fig. 12, and having a multi-layer structure composed of a first polarizer 310 (absorption axis azimuth angle of 90°), a first quarter-wave plate 320 (slow axis azimuth angle of 135°), a VA LC cell 330, a birefringent layer (III) 335, a second quarter-wave plate 340 (slow axis azimuth angle of 45°), a birefringent layer (II) 345 (fast axis azimuth angle of 90°), and a second polarizer 350 (absorption axis azimuth angle of 0°). To the configuration shown in Fig. 5, the birefringent layer (II) is added for optical compensation at an azimuth angle of 45°. In Fig. 12, the arrow shown in each of the first and second polarizers 310 and 350 represents an azimuth of the absorption axis thereof; the arrow shown in each of the first and second quarter-wave plates 320 and 340 represents an azimuth of the slow axis thereof; and the arrow shown in the

birefringent layer (II) 345 represents an azimuth of the fast axis thereof. The ellipsoidal bodies in the VA LC cell 330 and the birefringent layer (III) 335 show the shape of the respective refractive index ellipsoidal bodies thereof.

[0073] First, the polarization state when the CPVA LCD device 300 in Fig. 12 is viewed from the front direction is mentioned. Fig. 13 is a view showing changes in the polarization state of a light beam emitted from a backlight (not shown in Fig. 12, but located below the first polarizer 310), represented on S1-S2 plane of the Poincare sphere. The points in Fig. 13 show the respective polarization states at the output of the respective polarizers 310 and 350, the respective birefringent layers 320 and 340, and the LC cell 330.

[0074] The polarization state of the light beam just at the output of the first polarizer 310 is represented by P0 on the Poincare sphere and P0 corresponds to E showing a polarization state the second polarizer 350 can absorb, i.e., extinction position (absorption axis azimuth) of the second polarizer 350. Then, when the light beam passes through the first quarter-wave plate 320, P0 is moved to P1 by rotation by a specific angle around O the slow axis of the first quarter-wave plate 320 represented by Q1 on the Poincare sphere. The rotation is in a counterclockwise direction when the coordinate origin O is viewed from Q1 .

[0075] Successively, the light beam passes through the VA LC cell 330 and the birefringent layer (III) 335 but does not change in its polarization state because the cell 330 and the birefringent layer (III) 335 each have a retardation of zero in the front direction. Then the light beam passes through the second quarter-wave plate 340, and P1 reaches P2 by rotation by a specific angle around the slow axis of the second quarter-wave plate 340 represented by Q2. Finally, the light beam passes through the birefringent layer (II) 345, but the polarization state thereof represented by P2 is not changed even after the rotation by a specific angle around the fast axis of the birefringent layer (II) 345 represented by R2 on the Poincare sphere. This P2 corresponds to extinction position E of the second polarizer 350. Thus, the LCD device 300 of Fig. 12 can block the light beam from the backlight to display an excellent black screen when viewed from the front direction, as in the LCD device 100 of Fig. 1.

[0076] Next, the polarization state when the CPVA LCD device 200 in Fig. 12 is viewed from an oblique direction with an azimuth angle of 45° and a polar angle of 60° is mentioned. Fig. 14 is a view showing changes in the polarization state of a light beam emitted from a backlight under this condition, represented on S1-S2 plane of the Poincare sphere. The points in Fig. 14 show the respective polarization states at the output of the respective polarizers 310 and 350, the respective birefringent layers 320 and 340, and the LC cell 330.

[0077] The polarization state of the light beam just at the output of the first polarizer 310 is represented by P0 on the Poincare sphere and P0 does not correspond to E showing a polarization state the second polarizer 350 can absorb, i.e., extinction position (absorption axis azimuth) of the second polarizer 350. Then, when the light beam passes through the first quarter-wave plate 320, P0 reaches P1 by rotation by a specific angle around the slow axis of the first quarter-wave plate 320 represented by Q1 on the Poincare sphere. The rotation is in a counterclockwise direction when the coordinate origin O is viewed from Q1.

[0078] Successively, the light beam passes through the VA LC cell 330, and P1 is moved to P2 by rotation by a specific angle with respect to the slow axis of the LC cell 330 represented by L on the Poincare sphere. The rotation is in the counterclockwise direction when the coordinate origin O is viewed from L. Then the light beam passes through the birefringent layer (III) 335, and P2 reaches P3 by rotation by a specific angle around the slow axis of the birefringent layer (III) 335 represented by R3 on the Poincare sphere. The rotation is in the counterclockwise direction when the coordinate origin O is viewed from R3. Then the light beam passes through the second quarter-wave plate 340, and P3 reaches P4 by rotation by a specific angle with respect to the slow axis of the second quarter-wave plate 340 represented by Q2. Finally, the light beam passes through the birefringent layer (II) 345, and P4 reaches P5 by rotation by a specific angle around the fast axis of the birefringent layer (II) 345 represented by R2 on the Poincare sphere. The rotation is in a clockwise direction when the coordinate origin O is viewed from R2. This P5 corresponds to extinction position E of the second polarizer 350. Thus, the LCD device 300 of Fig. 12 can block the light beam from the backlight when viewed from the oblique direction with an azimuth angle of 45° and a polar angle of 60° , similarly in the front direction.

[0079] Finally, mentioned is the case where the CPVA LCD device 300 of Fig. 12 is viewed from an oblique direction with an azimuth angle of 0° and a polar angle of 60° . Fig. 15 is a view showing changes in the polarization state of a light beam emitted from a backlight under this condition, represented on S1-S2 plane of the Poincare sphere. The points in Fig. 15 show the respective polarization states at the output of the respective polarizers 310 and 350, the birefringent layer 320 and 340, and the LC cell 330.

[0080] The polarization state of the light beam just at the output of the first polarizer 310 is represented by P0 on the Poincare sphere and P0 corresponds to E showing a polarization state the second polarizer 350 can absorb, i.e., extinction position (absorption axis azimuth) of the second polarizer 350. Then, when the light beam passes through the first quarter-wave plate 320, P0 reaches P1 by rotation by a specific angle around the slow axis of the first quarter-wave plate 320 represented by Q1 on the Poincare sphere. The rotation is in a counterclockwise direction when the coordinate origin O is viewed from Q1.

[0081] Successively, the light beam passes through the VA LC cell 330, and P1 reaches P2 by rotation by a specific angle around the slow axis of the LC cell 330, represented by L on the Poincare sphere. The rotation is in a counter-

clockwise direction when the coordinate origin O is viewed from L. Then, the light beam passes through the birefringent layer (III) 335, and P2 reaches P3 by rotation by a specific angle with respect to the slow axis of the birefringent layer (III) 335, represented by R3 on the Poincare sphere. Then the light beam passes through the second quarter-wave plate 340, and P3 reaches P4 by rotation by a specific angle around the slow axis of the second quarter-wave plate 340, represented by Q2. Finally, the light beam passes through the birefringent layer (II) 345, but the polarization state represented by P4 is not changed even after the rotation by a specific angle around the fast axis of the birefringent layer (II) 345 represented by R2 on the Poincare sphere. This P4 corresponds to extinction position E of the second polarizer 350. Thus, the LCD device 300 of Fig. 12 can block the light beam from the backlight to display an excellent black screen when viewed from the oblique direction with an azimuth angle of 0° and a polar angle of 60°, similarly in the front direction.

[0082] Thus, the LCD device 300 in Fig. 12 having undergone the 2nd step can block the light beam from the backlight in each of the front direction and the oblique directions with the respective azimuths of 0° and 45°.

[0083] The positions of P1 to P5 in Figs. 13, 14, and 15 depend on the Nz coefficient Nzq of each of the first and second quarter-wave plates 320 and 340, the thickness-direction retardation Rlc of the LC cell 330, the thickness-direction retardation R3 of the birefringent layer (III) 335, and the Nz coefficient Nz2 and the retardation R2 of the birefringent layer (II) 345. Figs. 13, 14, and 15 show, as an example, the embodiment where Nzq = 1.6, Rlc = 320 nm, R3 = -129 nm, Nz2 = -0.30, and R2 = 118 nm are satisfied. For simply showing the conversion of the polarization state, the positions of the respective points are roughly shown and might not be accurate. For ease of illustration, the arrows showing tracing from P1 to P5 are not shown.

[0084] The inventor's studies determined that the optimum values each of the Nz coefficient Nz2 and the retardation R2 of the birefringent layer (II) 345 vary depending on the Nz coefficient Nzq of each of the first and second quarter-wave plates 320 and 340. Figs. 16 and 17 are views each showing changes in the polarization state when the CPVA LCD device 300 in Fig. 12 is viewed from the oblique direction with an absorption axis azimuth 45° of the second polarizer 350 and a polar angle of 60°, represented on S1-S2 plane of the Poincare sphere. Fig. 16 shows the embodiment where Nzq = 2.0, Rlc = 320 nm, R3 = -61 nm, Nz2 = -1.00, and R2 = 94 nm are satisfied. Fig. 17 shows the embodiment where Nzq = 2.35, Rlc = 320 nm, R3 = 0 nm, Nz2 = -1.80, and R2 = 90 nm are satisfied.

[0085] As shown in Figs. 15, 16, and 17, the larger Nz coefficient Nzq the first and second quarter-wave plates 320 and 340 have, the larger distance from E showing extinction position P4 showing the polarization state just before passage through the birefringent layer 345 has. Therefore, in order that P4 corresponds to E, the radius of the rotation in P4-P5 conversion is required to be larger. As a result of the inventor's studies, the biaxiality of the birefringent layer (II) 345 is required to be larger for an increase in radius of the rotation.

[0086] Table 3 and Figs. 18 and 19 show a relationship between the Nz coefficients Nzq of the first and second quarter-wave plates 320 and 340, and the optimum values each of the Nz coefficient Nz2 and the in-plane retardation R2 of the birefringent layer (II) 345, based on the results determined by computer simulations. As shown in Table 3 and Figs. 18 and 19, the relationship between Nz2 and R2 is not simple typically, but in the case of $1.0 \leq Nz \leq 2.9$, the following (B) and (C) give a sufficiently close approximation to Nz2 and R2, respectively, which are shown by the lines (solid line) in Figs. 18 and 19.

$$Nz2 = -0.63 \times Nzq^2 + 0.56 \times Nzq + 0.40 \quad (B)$$

$$R2 = 43 \text{ nm} \times Nzq^2 - 266 \text{ nm} \times Nzq + 370 \text{ nm} \quad (C)$$

[0087] The values Nz2 and R2 of the birefringent layer (II) 345 are most preferably the optimum values shown in Table 3 and Figs. 18 and 19, respectively, in order to provide LC display with a high contrast ratio in a wide viewing angle range. However, the values may slightly deviate from the respective optimum values unless the contrast ratio in oblique directions is significantly reduced. For sufficient advantageous effects of the invention, the Nz coefficient Nz2 is preferably within the optimum value ± 0.35 . The in-plane retardation R2 is preferably within the optimum value ± 30 nm.

[0088] As shown in Table 3 and Fig. 18, in the case of $Nzq < 1.40$, the optimum value Nz2 is in a range of $0 < Nz2 < 1$. The birefringent layer having the Nz coefficient satisfying this range is a biaxial retardation film satisfying $n_x > n_z > n_y$. Accordingly, such a layer does not correspond to the second birefringent layer (II) and is an expensive film that is harder to produce than the birefringent layer (II) is. Under this circumstance, the present inventor made various investigations on a simple and cost-effective method of providing LC display with a high contrast ratio in a wide viewing angle range in the case of $Nzq < 1.40$.

As a result, in the case of $Nzq < 1.40$, use of the birefringent layer (II) satisfying $Nz2 = 0$ and $R2 = 138$ nm, instead of the birefringent layer satisfying the optimum values Nz2 and R2 shown in Table 3 and Figs. 18 and 19, contributes to sufficient advantageous effects of the present invention. For example, in each of the cases of $Nzq = 1.00, 1.10, 1.20,$

and 1.30, the calculated optimum value R2 is 138 nm when Nz2 = 0 regardless of the value Nzq. In order to sufficiently exhibit the advantageous effects of the present invention, it is preferable that $-0.35 \leq Nz2 \leq 0$ and $108 \text{ nm} \leq R2 \leq 168 \text{ nm}$ (within the optimum value $138 \text{ nm} \pm 30 \text{ nm}$) are satisfied.

[0089]

[Table 3]

Nzq	Nz2	R2(nm)
1. 00	0. 35	186
1. 10	0. 25	169
1. 20	0. 15	154
1. 30	0. 10	148
1. 40	-0. 05	134
1. 50	-0. 15	127
1. 60	-0. 30	118
1. 70	-0. 45	111
2. 00	-1. 00	94
2. 30	-1. 65	81
2. 40	-1. 90	78
2. 50	-2. 15	75
2. 90	-3. 20	66

EFFECT OF THE INVENTION

[0090] The LCD device of the present invention has a high contrast ratio in a wide viewing angle range and can be easily produced at low cost. Such an LCD device of the present invention can be preferably used in display devices such as outdoor signage display devices.

BRIEF DESCRIPTION OF THE DRAWINGS

[0091]

[Fig. 1]

Fig. 1 is an exploded perspective view showing a configuration of a CPVA LCD device having the simplest configuration, not including birefringent layers (II) and (III).

[Fig. 2]

Fig. 2(a) is a schematic view showing slow axes each of first and second quarter-wave plates that are orthogonal to each other in the front direction when viewed in the front direction (the upper view); and also is a schematic view showing that when viewed in an oblique direction with an azimuth angle of 0° (the lower view).

Fig. 2(b) is a schematic view showing slow axes each of the first and second quarter-wave plates that are orthogonal to each other in the front direction when viewed in the front direction (the upper view); and also is a schematic view that when viewed in an oblique direction with an azimuth angle of 45° (the lower view).

Fig. 2(c) is a schematic view showing absorption axes each of the first and second quarter-wave plates that are orthogonal to each other in the front direction when viewed in the front direction (the upper view); and is a schematic view showing that when viewed in an oblique direction with an azimuth angle of 45° (the lower view).

[Fig. 3]

Fig. 3 is a view showing changes in polarization state of a transmissive light beam at the output of the respective members in the case where the CPVA LCD device in Fig. 1 is viewed in the front direction, represented on S1-S2 plane of the Poincare sphere.

[Fig. 4]

Fig. 4 is a view showing changes in polarization state of a transmissive light beam at the output of the respective members in the case where the CPVA LCD device in Fig. 1 is viewed in an oblique direction with an azimuth angle of 0° and a polar angle of 60° , represented on S1-S2 plane of the Poincare sphere.

[Fig. 5]

Fig. 5 is an exploded perspective view showing a configuration of a CPVA LCD device including a birefringent layer (III).

[Fig. 6]

Fig. 6 is a view showing changes in polarization state of a transmissive light beam at the output of the respective members in the case where the CPVA LCD device in Fig. 5 ($Nzq = 1.6$, $Rlc = 320$ nm, $R3 = -129$ nm) is viewed from the front direction, represented on S1-S2 plane of the Poincare sphere.

[Fig. 7]

Fig. 7 is a view showing changes in polarization state of a transmissive light beam at the output of the respective members in the case where the CPVA LCD device in Fig. 5 ($Nzq = 1.6$, $Rlc = 320$ nm, $R3 = -129$ nm) is viewed from an oblique direction with an azimuth angle of 0° and a polar angle of 60° , represented on S1-S2 plane of the Poincare sphere.

[Fig. 8]

Fig. 8 is a view showing changes in polarization state of a transmissive light beam at the output of the respective members in the case where the CPVA LCD device in Fig. 5 ($Nzq = 2.0$, $Rlc = 320$ nm, $R3 = -61$ nm) is viewed from an oblique direction with an azimuth angle of 0° and a polar angle of 60° , represented on S1-S2 plane of the Poincare sphere.

[Fig. 9]

Fig. 9 is a view showing changes in polarization state of a transmissive light beam at the output of the respective members in the case where the CPVA LCD device in Fig. 5 ($Nzq = 2.35$, $Rlc = 320$ nm, $R3 = -61$ nm) is viewed from an oblique direction with an azimuth angle of 0° and a polar angle of 60° , represented on S1-S2 plane of the Poincare sphere.

[Fig. 10]

Fig. 10 is a graph showing a relationship between an Nz coefficient Nzq of each of first and second quarter-wave plates and an optimum thickness-direction retardation $R3$ of a birefringent layer (III) in the CPVA LCD device in Fig. 5.

[Fig. 11]

Fig. 11 is a view showing changes in polarization state of a transmissive light beam at the output of the respective members in the case where the CPVA LCD device in Fig. 5 is viewed from an oblique direction with an azimuth angle of 45° and a polar angle of 60° , represented on S1-S2 plane of the Poincare sphere.

[Fig. 12]

Fig. 12 is an exploded perspective view showing a CPVA LCD device including birefringent layers (II) and (III).

[Fig. 13]

Fig. 13 is a view showing changes in polarization state of a transmissive light beam at the output of the respective members in the case where the CPVA LCD device in Fig. 12 ($Nzq = 1.6$, $Rlc = 320$ nm, $R3 = -129$ nm, $Nz2 = -0.30$, $R2 = 118$ nm) is viewed from the front direction, represented on S1-S2 plane of the Poincare sphere.

[Fig. 14]

Fig. 14 is a view showing changes in polarization state of a transmissive light beam at the output of the respective members in the case where the CPVA LCD device in Fig. 12 ($Nzq = 1.6$, $Rlc = 320$ nm, $R3 = -129$ nm, $Nz2 = -0.30$, $R2 = 118$ nm) is viewed from an oblique direction with an azimuth angle of 45° and a polar angle of 60° , represented on S1-S2 plane of the Poincare sphere.

[Fig. 15]

Fig. 15 is a view showing changes in polarization state of a transmissive light beam at the output of the respective members in the case where the CPVA LCD device in Fig. 12 ($Nzq = 1.6$, $Rlc = 320$ nm, $R3 = -129$ nm, $Nz2 = -0.30$, $R2 = 118$ nm) is viewed from an oblique direction with an azimuth angle of 0° and a polar angle of 60° , represented on S1-S2 plane of the Poincare sphere.

[Fig. 16]

Fig. 16 is a view showing changes in polarization state of a transmissive light beam at the output of the respective members in the case where the CPVA LCD device in Fig. 12 ($Nzq = 2.0$, $Rlc = 320$ nm, $R3 = -61$ nm, $Nz2 = -1.00$, $R2 = 94$ nm) is viewed from an oblique direction with an azimuth angle of 45° and a polar angle of 60° , represented on S1-S2 plane of the Poincare sphere.

[Fig. 17]

Fig. 17 is a view showing changes in polarization state of a transmissive light beam at the output of the respective members in the case where the CPVA LCD device in Fig. 12 ($Nzq = 2.35$, $Rlc = 320$ nm, $R3 = 0$ nm, $Nz2 = -1.80$, $R2 = 90$ nm) is viewed from an oblique direction with an azimuth angle of 45° and a polar angle of 60° , represented on S1-S2 plane of the Poincare sphere.

[Fig. 18]

Fig. 18 is a graph showing a relationship between an Nz coefficient Nzq of each of first and second quarter-wave plates and an optimum in-plane retardation R2 of a birefringent layer (II).

[Fig. 19]

Fig. 19 is a graph showing a relationship between an Nz coefficient Nzq of each of first and second quarter-wave plates and an optimum in-plane retardation R2 of a birefringent layer (II).

[Fig. 20]

Fig. 20 is an exploded perspective view showing a configuration of a CPVA LCD device including a birefringent layer (II).

[Fig. 21]

Fig. 21(a) is an enlarged view schematically showing a cross section of a moth-eye film.

Fig. 21(b) is an explanation view showing a change in refractive index on an interface between a moth-eye film and air.

[Fig. 22]

Fig. 22 is an exploded perspective view showing a configuration of the CPVA LCD device in Fig. 12 with which a moth-eye film is further provided.

BEST MODE FOR CARRYING OUT THE INVENTION

(Birefringent layer)

[0092] With respect to the birefringent layers used in the present invention, materials and optical characteristics thereof are not especially limited. Examples of the materials include thin plates made of inorganic materials, stretched polymer films, and ones in which alignment of liquid crystalline molecules is fixed. The method for forming the birefringent layers is not especially limited. The polymer films may be formed by solvent cast, melt extrusion, and the like. Alternatively, coextrusion may be employed to form a plurality of birefringent layers at a time. The polymer films may or may not be stretched as long as desired retardations can be exhibited. The stretching method is not especially limited. The polymer films may be stretched under tension between rolls, compressed and stretched between rolls, uniaxially stretched in a transverse direction with a tenter, stretched in an oblique direction, or biaxially stretched in longitudinal and transverse directions. Alternatively, the polymer films may be stretched under the influence of contractile force of a thermo-shrinkable film. Particularly the quarter-wave plate is preferably produced by being stretching a polymer film in a direction oblique to a feeding direction of a roll film because this quarter-wave plate is stacked on a polarizer so as to form a relative angle of about 45° with a polarizer to serve as a circular polarizer. When the liquid crystalline materials are used, for example, liquid crystalline molecules are applied on a base film with an alignment treatment-provided surface, and thereby fixing alignment of the liquid crystalline molecules. The base film may not be provided with the alignment treatment or the coating may be separated from the base film after the alignment fixing to be transferred onto another film as long as the desired retardations are exhibited. Alternatively, the alignment of the LC molecules may not be fixed. The same methods as in use of the liquid crystalline materials may be employed when non-crystalline materials are used. The following will in more detail describe the birefringent layers classified by types.

(Birefringent layer (I): First and second quarter-wave plates)

[0093] The birefringent layer (I) may include a material formed by stretching a film containing a component with positive intrinsic birefringence. Examples of the component with positive intrinsic birefringence include polycarbonate, polysulfone, polyether sulfone, polyethylene terephthalate, polyethylene, polyvinyl alcohol, norbornene, triacetyl cellulose, and diatyl cellulose.

(Birefringent layer (II))

[0094] The birefringent layer (II) may include a material formed by stretching a film containing a component with negative intrinsic birefringence or one formed by stretching a film containing a component with positive intrinsic birefringence under the influence of contractile force of a thermo-shrinkable film. For simplification of the production method, one formed by stretching a film containing a component with negative intrinsic birefringence is preferable. Examples of the component with negative intrinsic birefringence include polystyrene, polyvinyl naphthalene, polyvinyl biphenyl, polyvinyl pyridine, polymethyl methacrylate, polymethyl acrylate, an N-substituted maleimide copolymer, fluorene skeleton-containing polycarbonate, and triacetyl cellulose (particularly with a small acetylation degree). In view of optical char-

acteristics, productivity, and heat resistance, a resin composition containing an acrylic resin and a styrene resin is particularly preferable as the component with negative intrinsic birefringence. For example, Japanese Kokai Publication No. 2008-146003 discloses a production method of a film containing such a resin composition.

5 (Birefringent layer (III))

[0095] The birefringent layer (III) may include a material formed by stretching in longitudinal and transverse directions a film containing a component with positive intrinsic birefringence, one coated with a liquid crystalline compound e.g. a cholesteric (chiral nematic) liquid crystal and a discotic liquid crystal, and one coated with a non-liquid crystalline compound including a polymer e.g. polyimide and polyamide.

(Polarizer)

[0096] The polarizers may include a polyvinyl alcohol (PVA) film with a dichroic anisotropic material such as an iodine complex adsorbed and aligned thereon.

(LC cell)

[0097] The LC cell is not especially limited as long as it can display a black screen by aligning LC molecules in the LC cell vertically to the substrate surface, and VA LC cells may be employed, for example. Examples of the VA LC cells include MVA, CPA, PVA, BVA, Reverse TN LC cells, and IPS-VA (in-plane switching-VA). Examples of a driving system of the LC cell include TFT system (active matrix system), passive matrix system, and plasma address system. The LC cell has a configuration, for example, in which LCs are disposed between a pair of substrates each provided with electrodes and display is provided by voltage application between the electrodes.

(Method for measuring R, Rth, Nz coefficient, nx, ny, and nz)

[0098] R, Rth, Nz coefficient, nx, ny, and nz were measured with a dual-rotating retarder polarimeter (Axo-scan, Axometrics, Inc.). In-plane retardation R was measured from the normal direction of the birefringent layer. Principal refractive indices nx, ny, and nz, thickness-direction retardation Rth, and Nz coefficient were calculated by curve fitting with a known index ellipsoid. For the calculation, retardations of the birefringent layer were measured from the normal direction and the directions each with a polar angle of -50° to 50° from the normal direction. Azimuths of the inclinations each were made orthogonal to the in-plane slow axis. Rxz, Nz, nx, ny, and nz depend on the average refractive index $= (nx+ny+nz)/3$, which is given as the condition for the curve fitting calculation. Here, the average refractive index of each birefringent layer was set to 1.5. Even in the case of the birefringent layer having an actual average refractive index of not 1.5, the average refractive index was converted into 1.5.

(Method for measuring viewing angle dependence of contrast of LCD device)

[0099] The viewing angle dependence of contrast was measured with a viewing angle measuring apparatus (EZContrast 160, ELDIM). The light source was a backlight mounted on a LC TV (LC37-GH1, SHARP Corp.). Brightnesses upon displaying a white screen and a black screen were measured in the oblique direction with an azimuth angle of 45° and a polar angle of 60° . The ratio thereof was regarded as CR (45, 60). Brightnesses upon displaying a white screen and a black screen were measured in the oblique direction with an azimuth angle of 0° and a polar angle of 60° . The ratio thereof was regarded as CR (0, 60).

[0100] The present invention is mentioned in more detail showing embodiments but not limited to these embodiments.

[0101] The LCD devices in Embodiments 1 to 13 and Reference Embodiments 1 to 22 of the present invention are a CPVA LCD device 300 having a multi-layer structure including, as shown in Fig. 12, a first polarizer 310, a first quarter-wave plate (birefringent layer (I)) 320, a VA LC cell 330, a birefringent layer (III) 335, a second quarter-wave plate 340, a birefringent layer (II) 345, and a birefringent layer (III) 335, a second quarter-wave plate 340, a birefringent layer (II) 345, and a second polarizer 350 stacked in this order.

[0102] The LCD devices in Embodiments 14 to 18 and Reference Embodiments 23 to 52 are a CPVA LCD device 400 having a multi-layer structure including, as shown in Fig. 20, a first polarizer 410, a first quarter-wave plate (birefringent layer (I)) 420, a VA LC cell 430, a second quarter-wave plate 440, a birefringent layer (II) 445, and a second polarizer 450 stacked in this order. Specifically, the LCD device 400 shown in Fig. 20 is different from that in Fig. 12 in that the birefringent layer (III) is not included. In Fig. 20, the arrow in each of the first and second polarizers 410 and 450 shows an azimuth of the absorption axis thereof; the arrow in each of the first and second quarter-wave plates 420 and 440 shows an azimuth of the slow axis thereof; the arrow in the birefringent layer (II) 445 shows an azimuth of the fast axis

thereof; and the ellipsoidal body in the VA LC cell 430 shows the shape of the refractive index ellipsoidal body thereof.

[0103] The LCD device of Comparative Embodiment 1 is a VA LCD device including a first polarizer, a TAC film, a first quarter-wave plate (birefringent layer (I)), a VA LC cell, a second quarter-wave plate, a TAC film, and a second polarizer, stacked in this order. The LCD device of Comparative Embodiment 2 is a VA LCD device including a first polarizer, a TAC film, a first quarter-wave plate (birefringent layer (I)), a VA LC cell, a birefringent layer (III), a quarter-wave plate (II), a TAC film, and a second polarizer, stacked in this order.

[0104] The material name, axial angle, in-plane retardation R, thickness-direction retardation R_{th} or R_{lc}, and N_z coefficient of the polarizers, the birefringent layers, and the LC cell of the respective Embodiments are as shown in the following Table 4 (Embodiments 1 to 8), Table 5 (Embodiments 9 to 13), Table 6 (Embodiments 14 to 18), Table 7 (Reference Embodiments 1 to 8), Table 8 (Reference Embodiments 9 to 14), Table 9 (Reference Embodiments 15 to 22), Table 10 (Reference Embodiments 23 to 32), Table 11 (Reference Embodiments 33 to 42), and Table 12 (Reference Embodiments 43 to 52), and Table 13 (Comparative Embodiments 1 and 2). In Tables, the axis of each of the birefringent layers is defined by an azimuth angle of the in-plane slow axis, and the axis of each of the polarizers is defined by an azimuth angle of the absorption axis. With respect to the birefringent layer (II), the design of the in-plane fast axis is important, and in Tables, the axis of the birefringent layer (II) is defined by an azimuth angle of the in-plane slow axis, as in other birefringent layers. The in-plane fast axis of the birefringent layer (II) is orthogonal to the in-plane slow axis of the birefringent layer (II). In Tables, the name of the materials of the respective birefringent layers is indicated by means of the following abbreviations.

NB: norbornene

ChLC: cholesteric liquid crystal

PI: polyimide

TAC: triacetyl cellulose

A: resin composition containing acrylic resin and styrene resin

(Evaluation results)

[0105] The viewing angle dependence of contrast of the LCD device was determined in each embodiment, and the CR (45, 60) and the CR Δ (45, 60) were shown in Tables 4 to 13.

The LCD device in each of Embodiments 1 to 18 according to the present invention had a CR (0, 60) and a CR (45, 60) much higher than those in each of Comparative Embodiments 1 and 2. Even in the visual evaluation, the LCD devices of Embodiments 1 to 18 each had a contrast ratio less depending on the viewing angle than that of the LCD devices in Comparative Embodiments 1 and 2. had much better contrast ratio-viewing angle characteristics than those of Comparative Embodiments 1 and 2.

The LCD devices of Reference Embodiments 9 to 22 and 33 to 52 each had a CR (0, 69) and a CR (45, 60) higher than those, especially, a CR (45, 60) much higher than that in each of Comparative Embodiments 1 and 2. Even in the visual evaluation, the LCD devices of Reference Embodiments 9 to 22 and 33 to 52 each had a contrast ratio less depending on the viewing angle than that of the LCD devices in Comparative Embodiments 1 and 2.

[0106]

EP 2 383 604 A1

[Table 4]

	Optical components	Material	Angle [°]	Retardation [nm]		Nz coefficient	Evaluation results	
				R	Rth or Rlc		CR (45,60)	CR (0,60)
5 10 15 20	Embodiment 1	Second polarizer	0				35	178
	Birefringent layer (II)	A	0	138		-0.01		
	Second quarter-wave plate	NB	45	138		1.02		
	Birefringent layer (III)	PI		0	-250			
	VA liquid crystal cell				340			
	First quarter-wave plate	NB	135	138		1.02		
	First polarizer		90					
25 30 35 40	Embodiment 2	Second polarizer	0				34	178
	Birefringent layer (II)	A	0	138		-0.01		
	Second quarter-wave plate	NB	45	138		1.02		
	Birefringent layer (III)	PI		0	-233			
	VA liquid crystal cell				320			
	First quarter-wave plate	NB	135	138		1.02		
	First polarizer		90					

45

50

55

EP 2 383 604 A1

(continued)

	Optical components	Material	Angle [°]	Retardation [nm]		Nz coefficient	Evaluation results		
				R	Rth or Rlc		CR (45,60)	CR (0,60)	
5	Embodiment 3	Second polarizer	0				37	178	
10		Birefringent layer (II)	A	0	138				-0.01
15		Second quarter-wave plate	NB	45	138				1.10
20		Birefringent layer (III)	PI		0	-233			
		VA liquid crystal cell				340			
		First quarter-wave plate	NB	135	138				1.10
		First polarizer		90					
25	Embodiment 4	Second polarizer	0				37	176	
30		Birefringent layer (II)	A	0	138				-0.01
35		Second quarter-wave plate	NB	45	138				1.10
40		Birefringent layer (III)	PI		0	-212			
		VA liquid crystal cell				320			
		First quarter-wave plate	NB	135	138				1.10
		First polarizer		90					

45

50

55

EP 2 383 604 A1

(continued)

	Optical components	Material	Angle [°]	Retardation [nm]		Nz coefficient	Evaluation results		
				R	Rth or Rlc		CR (45,60)	CR (0,60)	
5	Embodiment 5	Second polarizer	0				38	177	
10		Birefringent layer (II)	A	0	138				-0.01
15		Second quarter-wave	NB	45	138				1.22
20		Birefringent layer (III)	PI		0	-212			
		VA liquid crystal cell				340			
		First quarter-wave plate	NB	135	138				1.10
		First polarizer		90					
25	Embodiment 6	Second polarizer	0				36	177	
30		Birefringent layer (II)	A	0	138				-0.01
35		Second quarter-wave plate	NB	45	138				1.22
40		Birefringent layer (III)	PI		0	-198			
		VA liquid crystal cell				320			
		First quarter-wave plate	NB	135	138				1.10
		First polarizer		90					

45

50

55

EP 2 383 604 A1

(continued)

	Optical components	Material	Angle [°]	Retardation [nm]		Nz coefficient	Evaluation results		
				R	Rth or Rlc		CR (45,60)	CR (0,60)	
5	Embodiment 7	Second polarizer	0				37	177	
10		Birefringent layer (II)	A	0	138				-0.01
15		Second quarter-wave plate	NB	45	138				1.31
20		Birefringent layer (III)	PI		0	-198			
		VA liquid crystal cell				340			
		First quarter-wave plate	NB	135	138				1.10
		First polarizer		90					
25	Embodiment 8	Second polarizer	0				37	178	
30		Birefringent layer (II)	A	0	138				-0.01
35		Second quarter-wave plate	NB	45	138				1.31
40		Birefringent layer (III)	PI		0	-177			
		VA liquid crystal cell				320			
		First quarter-wave plate	NB	135	138				1.10
		First polarizer		90					

[0107]

45

50

55

EP 2 383 604 A1

[Table 5]

	Optical components	Material	Angle [°]	Retardation [nm]		Nz coefficient	Evaluation results		
				R	Rth or Rlc		CR (45,60)	CR (0,60)	
5	Embodiment 9	Second polarizer	0				66	175	
10		Birefringent layer (II)	A	0	121				-0.32
15		Second quarter-wave plate	NB	45	138				1.58
20		Birefringent layer (III)	PI		1	-152			
		VA liquid crystal cell				340			
		First quarter-wave plate	NB	135	138				1.58
		First polarizer		90					
25	Embodiment 10	Second polarizer	0				65	178	
30		Birefringent layer (II)	A	0	121				-0.32
35		Second quarter-wave plate	NB	45	138				1.58
40		Birefringent layer (III)	PI		0	-127			
		VA liquid crystal cell				320			
		First quarter-wave plate	NB	135	138				1.58
		First polarizer		90					

45

50

55

EP 2 383 604 A1

(continued)

	Optical components	Material	Angle [°]	Retardation [nm]		Nz coefficient	Evaluation results		
				R	Rth or Rlc		CR (45,60)	CR (0,60)	
5	Embodiment 11	Second polarizer	0				65	174	
10		Birefringent layer (II)	A	0	75				-2.13
15		Second quarter-wave plate	NB	45	138				2.50
20		Birefringent layer (III)	TAC		2	-55			
		VA liquid crystal cell				400			
		First quarter-wave plate	NB	135	138				2.50
		First polarizer		90					
25	Embodiment 12	Second polarizer	0				60	176	
30		Birefringent layer (II)	A	0	70				-3.21
35		Second quarter-wave plate	NB	45	138				2.92
40		Birefringent layer (III)	TAC		2	-55			
		VA liquid crystal cell				462			
		First quarter-wave plate	NB	135	138				2.92
		First polarizer		90					

45

50

55

EP 2 383 604 A1

(continued)

	Optical components	Material	Angle [°]	Retardation [nm]		Nz coefficient	Evaluation results		
				R	Rth or Rlc		CR (45,60)	CR (0,60)	
5	Embodiment 13	Second polarizer	0				62	176	
10		Birefringent layer (II)	A	0	70				-3.21
15		Second quarter-wave plate	NB	45	138				2.92
20		Birefringent layer (III)	NB		2	-22			
		VA liquid crystal cell				433			
		First quarter-wave plate	NB	135	138				2.92
		First polarizer		90					

[0108]

[Table 6]

	Optical components	Material	Angle [°]	Retardation [nm]		Nz coefficient	Evaluation results		
				R	Rth or Rlc		CR (45,60)	CR (0,60)	
30	Embodiment 14	Second polarizer	0				58	175	
35		Birefringent layer (II)	A	0	85				-1.21
40		Second quarter-wave plate	NB	45	138				2.08
45		VA liquid crystal cell				290			
		First quarter-wave plate	NB	135	138				2.08
		First polarizer		90					

EP 2 383 604 A1

(continued)

	Optical components	Material	Angle [°]	Retardation [nm]		Nz coefficient	Evaluation results		
				R	Rth or Rlc		CR (45,60)	CR (0,60)	
5	Embodiment 15	Second polarizer	0				55	178	
10		Birefringent layer (II)	A	0	78				-1.58
15		Second quarter-wave plate	NB	45	138				2.31
20		VA liquid crystal cell				310			
		First quarter-wave plate	NB	135	138				2.31
		First polarizer		90					
25	Embodiment 16	Second polarizer	0				56	175	
30		Birefringent layer (II)	A	0	74				-1.87
35		Second quarter-wave plate	NB	45	138				2.37
40		VA liquid crystal cell				320			
45		First quarter-wave plate	NB	135	138				2.37
50		First polarizer		90					
55	Embodiment 17	Second polarizer	0				55	175	
		Birefringent layer (II)	A	0	70				-2.10
		Second quarter-wave plate	NB	45	138				2.48
		VA liquid crystal cell				340			
		First quarter-wave plate	NB	135	138				2.48
		First polarizer		90					

EP 2 383 604 A1

(continued)

	Optical components	Material	Angle [°]	Retardation [nm]		Nz coefficient	Evaluation results		
				R	Rth or Rlc		CR (45,60)	CR (0,60)	
5	Embodiment 18		0				52	172	
10		Birefringent layer (II)	A	0	68				-3.02
15		Second quarter-wave plate	NB	45	138				2.91
20		VA liquid crystal cell				400			
		First quarter-wave plate	NB	135	138				2.91
		First polarizer		90					

[0109]

[Table 7]

	Optical components	Material	Angle [°]	Retardation [nm]		Nz coefficient	Evaluation results		
				R	Rth or Rlc		CR (45,60)	CR (0,60)	
25	Reference Embodiment 1		0				35	145	
30		Birefringent layer (II)	A	0	138				-0.01
35		Second quarter-wave plate	NB	45	138				1.02
40		Birefringent layer (III)	PI		1	-272			
45		VA liquid crystal cell				320			
		First quarter-wave plate	NB	135	138				1.02
		First polarizer		90					

50

55

EP 2 383 604 A1

(continued)

	Optical components	Material	Angle [°]	Retardation [nm]		Nz coefficient	Evaluation results		
				R	Rth or Rlc		CR (45,60)	CR (0,60)	
5	Reference Embodiment 2	Second polarizer	0				33	143	
10		Birefringent layer (II)	A	0	138				-0.01
15		Second quarter-wave plate	NB	45	138				1.02
20		Birefringent layer (III)	PI		0	-195			
		VA liquid crystal cell				320			
		First quarter-wave plate	NB	135	138				1.02
		First polarizer		90					
25	Reference Embodiment 3	Second polarizer	0				36	142	
30		Birefringent layer (II)	A	0	121				-0.32
35		Second quarter-wave plate	NB	45	138				1.58
40		Birefringent layer (III)	PI		1	-170			
		VA liquid crystal cell				320			
		First quarter-wave plate	NB	135	138				1.58
		First polarizer		90					

45

50

55

EP 2 383 604 A1

(continued)

	Optical components	Material	Angle [°]	Retardation [nm]		Nz coefficient	Evaluation results		
				R	Rth or Rlc		CR (45,60)	CR (0,60)	
5	Reference Embodiment 4	Second polarizer	0				34	144	
10		Birefringent layer (II)	A	0	121				-0.32
15		Second quarter-wave plate	NB	45	138				1.58
20		Birefringent layer (III)	PI		0	-88			
		VA liquid crystal cell				320			
		First quarter-wave plate	NB	135	138				1.58
		First polarizer		90					
25	Reference Embodiment 5	Second polarizer	0				33	144	
30		Birefringent layer (II)	A	0	70				-2.13
35		Second quarter-wave plate	NB	45	138				2.50
40		Birefringent layer (III)	PI		0	-105			
		VA liquid crystal cell				400			
		First quarter-wave plate	NB	135	138				2.50
		First polarizer		90					

45

50

55

EP 2 383 604 A1

(continued)

	Optical components	Material	Angle [°]	Retardation [nm]		Nz coefficient	Evaluation results		
				R	Rth or Rlc		CR (45,60)	CR (0,60)	
5	Reference Embodiment 6	Second polarizer	0				29	146	
10		Birefringent layer (II)	A	0	75				-2.13
15		Second quarter-wave plate	NB	45	138				2.50
20		(Birefringent layer (III))	NB		2	-22			
		VA liquid crystal cell				400			
		First quarter-wave plate	NB	135	138				2.50
		First polarizer		90					
25	Reference Embodiment 7	Second polarizer	0				31	139	
30		Birefringent layer (II)	A	0	70				-3.21
35		Second quarter-wave plate	NB	45	138				2.92
40		Birefringent layer (III)	PI		0	-105			
		VA liquid crystal cell				462			
		First quarter-wave plate	NB	135	138				2.92
		First polarizer		90					

45

50

55

EP 2 383 604 A1

(continued)

	Optical components	Material	Angle [°]	Retardation [nm]		Nz coefficient	Evaluation results		
				R	Rth or Rlc		CR (45,60)	CR (0,60)	
5	Reference Embodiment 8		0				31	141	
10		Birefringent layer (II)	A	0	70				-3.21
15		Second quarter-wave plate	NB	45	138				2.92
20		Birefringent layer (III)	NB		2	-22			
		VA liquid crystal cell				462			
		First quarter-wave plate	NB	135	138				2.92
		First polarizer		90					

[0110]

[Table 8]

	Optical components	Material	Angle [°]	Retardation [nm]		Nz coefficient	Evaluation results		
				R	Rth or Rlc		CR (45,60)	CR (0,60)	
30	Reference Embodiment 9		0				25	178	
35		Birefringent layer (II)	A	0	183				-0.12
40		Second quarter-wave plate	NB	45	138				1.02
45		Birefringent layer (III)	PI		0	-232			
		VA liquid crystal cell				320			
		First quarter-wave plate	NB	135	138				1.02
50		First polarizer		90					

55

EP 2 383 604 A1

(continued)

	Optical components	Material	Angle [°]	Retardation [nm]		Nz coefficient	Evaluation results		
				R	Rth or Rlc		CR (45,60)	CR (0,60)	
5	Reference Embodiment 10	Second polarizer	0				28	177	
10		Birefringent layer (II)	A	0	120				-0.81
15		Second quarter-wave plate	NB	45	138				1.58
20		Birefringent layer (III)	ChLC		1	-129			
		VA liquid crystal cell				320			
		First quarter-wave plate	NB	135	138				1.58
		First polarizer		90					
25	Reference Embodiment 11	Second polarizer	0				22	172	
30		Birefringent layer (II)	A	0	75				-1.70
35		Second quarter-wave plate	NB	45	138				2.50
40		(Birefringent layer (III))	TAC		2	-55			
		VA liquid crystal, cell				400			
		First quarter-wave plate	NB	135	138				2.50
		First polarizer		90					

45

50

55

EP 2 383 604 A1

(continued)

	Optical components	Material	Angle [°]	Retardation [nm]		Nz coefficient	Evaluation results		
				R	Rth or Rlc		CR (45,60)	CR (0,60)	
5	Reference Embodiment 12	Second polarizer	0				25	177	
10		Birefringent layer (II)	A	0	75				-2.51
15		Second quarter-wave plate	NB	45	138				2.50
20		Birefringent layer (III)	TAC		2	-55			
		VA liquid crystal cell				400			
		First quarter-wave plate	NB	135	138				2.50
		First polarizer		90					
25	Reference Embodiment 13	Second polarizer	0				23	175	
30		Birefringent layer (II)	A	0	71				-2.83
35		Second quarter-wave plate	NB	45	138				2.92
40		Birefringent layer (III)	TAC		2	-55			
		VA liquid crystal cell				462			
		First quarter-wave plate	NB	135	138				2.92
		First polarizer		90					

45

50

55

EP 2 383 604 A1

(continued)

	Optical components	Material	Angle [°]	Retardation [nm]		Nz coefficient	Evaluation results		
				R	Rth or Rlc		CR (45,60)	CR (0,60)	
5	Reference Embodiment 14	Second polarizer	0				25	175	
10		Birefringent layer (II)	A	0	71				-3.69
15		Second quarter-wave plate	NB	45	138				2.92
20		Birefringent layer (III)	TAC		2	-55			
		VA liquid crystal cell				462			
		First quarter-wave plate	NB	135	138				2.92
		First polarizer		90					

[0111]

[Table 9]

	Optical components	Material	Angle [°]	Retardation [nm]		Nz coefficient	Evaluation results		
				R	Rth or Rlc		CR (45,60)	CR (0,60)	
30	Reference Embodiment 15	Second polarizer	0				33	178	
35		Birefringent layer (II)	A	0	185				-0.01
40		Second quarter-wave plate	NB	45	138				1.02
45		Birefringent layer (III)	PI		0	-232			
		VA liquid crystal cell				320			
		First quarter-wave plate	NB	135	138				1.02
50		First polarizer		90					

55

EP 2 383 604 A1

(continued)

	Optical components	Material	Angle [°]	Retardation [nm]		Nz coefficient	Evaluation results		
				R	Rth or Rlc		CR (45,60)	CR (0,60)	
5	Reference Embodiment 16	Second polarizer	0				30	177	
10		Birefringent layer (II)	A	0	101				-0.01
15		Second quarter-wave plate	NB	45	138				1.02
20		Birefringent layer (III)	PI		1	-232			
		VA liquid crystal cell				320			
		First quarter-wave plate	NB	135	138				1.02
		First polarizer		90					
25	Reference Embodiment 17	Second polarizer	0				27	177	
30		Birefringent layer (II)	A	0	152				-0.32
35		Second quarter-wave plate	NB	45	138				1.58
40		Birefringent layer (III)	PI		0	-129			
		VA liquid crystal cell				320			
		First quarter-wave plate	NB	135	138				1.58
		First polarizer		90					

45

50

55

EP 2 383 604 A1

(continued)

	Optical components	Material	Angle [°]	Retardation [nm]		Nz coefficient	Evaluation results		
				R	Rth or Rlc		CR (45,60)	CR (0,60)	
5	Reference Embodiment 18	Second polarizer	0				31	174	
10		Birefringent layer (II)	A	0	85				-0.32
15		Second quarter-wave plate	NB	45	138				1.58
20		Birefringent layer (III)	PI		0	-129			
		VA liquid crystal cell				320			
		First quarter-wave plate	NB	135	138				1.58
		First polarizer		90					
25	Reference Embodiment 19	Second polarizer	0				28	174	
30		Birefringent layer (II)	A	0	112				-2.13
35		Second quarter-wave plate	NB	45	138				2.50
40		Birefringent layer (II)	TAC		2	-55			
		VA liquid crystal cell				400			
		First quarter-wave plate	NB	135	138				2.50
		First polarizer		90					

45

50

55

EP 2 383 604 A1

(continued)

	Optical components	Material	Angle [°]	Retardation [nm]		Nz coefficient	Evaluation results		
				R	Rth or Rlc		CR (45,60)	CR (0,60)	
5	Reference Embodiment 20	Second polarizer	0				26	174	
10		Birefringent layer (II)	A	0	41				-2.13
15		Second quarter-wave plate	NB	45	138				2.50
20		Birefringent layer (III)	TAC		2	-55			
		VA liquid crystal cell				400			
		First quarter-wave plate	NB	135	138				2.50
		First polarizer		90					
25	Reference Embodiment 21	Second polarizer	0				23	175	
30		Birefringent layer (II)	A	0	110				-3.31
35		Second quarter-wave plate	NB	45	138				2.92
40		Birefringent layer (III)	TAC		2	-55			
		VA liquid crystal cell				462			
		First quarter-wave plate	NB	135	138				2.92
		First polarizer		90					

45

50

55

EP 2 383 604 A1

(continued)

	Optical components	Material	Angle [°]	Retardation [nm]		Nz coefficient	Evaluation results		
				R	Rth or Rlc		CR (45,60)	CR (0,60)	
5	Reference Embodiment 22	Second polarizer	0				25	175	
10		Birefringent layer (II)	A	0	42				-3.28
15		Second quarter-wave plate	NB	45	138				2.92
		(Birefringent layer (III))	TAC		2	-55			
20		VA liquid crystal cell				462			
		First quarter-wave plate	NB	135	138				2.92
		First polarizer		90					

[0112]

[Table 10]

	Optical components	Material	Angle [°]	Retardation [nm]		Nz coefficient	Evaluation results		
				R	Rth or Rlc		CR (45,60)	CR (0,60)	
30	Reference Embodiment 23	Second polarizer	0				38	151	
35		Birefringent layer (II)	A	0	85				-1.21
40		Second quarter-wave plate	NB	45	138				2.08
		VA liquid crystal cell				325			
45		First quarter-wave plate	NB	135	138				2.08
		First polarizer		90					

EP 2 383 604 A1

(continued)

	Optical components	Material	Angle [°]	Retardation [nm]		Nz coefficient	Evaluation results		
				R	Rth or Rlc		CR (45,60)	CR (0,60)	
5	Reference Embodiment 24	Second polarizer	0				39	148	
10		Birefringent layer (II)	A	0	85				-1.21
15		Second quarter-wave plate	NB	45	138				2.08
20		VA liquid crystal cell				244			
		First quarter-wave plate	NB	135	138				2.08
		First polarizer		90					
25	Reference Embodiment 25	Second polarizer	0				35	144	
30		Birefringent layer (II)	A	0					-1.58
35		Second quarter-wave plate	NB	45	138				2.31
		VA liquid crystal cell				345			
		First quarter-wave plate	NB	135	138				2.31
		First polarizer		90					
40	Reference Embodiment 26	Second polarizer	0				38	142	
45		Birefringent layer (II)	A	0	78				-1.58
50		Second quarter-wave plate	NB	45	138				2.31
		VA liquid crystal cell				273			
		First quarter-wave plate	NB	135	138				2.31
		First polarizer		90					

55

EP 2 383 604 A1

(continued)

	Optical components	Material	Angle [°]	Retardation [nm]		Nz coefficient	Evaluation results		
				R	Rth or Rlc		CR (45,60)	CR (0,60)	
5	Reference Embodiment 27	Second polarizer	0				37	140	
10		Birefringent layer (II)	A	0	74				
15		Second quarter-wave plate	NB	45	138				-1.87
20		VA liquid crystal cell				353			2.37
		First quarter-wave plate	NB	135	138				2.37
		First polarizer		90					
25	Reference Embodiment 28	Second polarizer	0				35	139	
30		Birefringent slayer (II)	A	0	74				-1.87
		Second quarter-wave plate	NB	45	138				2.37
		VA liquid crystal cell				287			
35		First quarter-wave plate	NB	135	138				2.37
		First polarizer		90					
40	Reference Embodiment 29	Second polarizer	0				36	142	
45		Birefringent layer (II)	A	0	70				-2.10
		Second quarter-wave plate	NB	45	138				2.48
50		VA liquid crystal cell				375			
		First quarter-wave plate	NB	135	138				2.48
		First polarizer		90					

55

EP 2 383 604 A1

(continued)

	Optical components	Material	Angle [°]	Retardation [nm]		Nz coefficient	Evaluation results		
				R	Rth or Rlc		CR (45,60)	CR (0,60)	
5	Reference Embodiment 30	Second polarizer	0				34	144	
10		Birefringent layer (II)	A	0	70				-2.10
15		Second quarter-wave plate.	NB	45	138				2.48
20		VA liquid crystal cell				305			
		First quarter-wave plate	NB	135	138				2.48
		First polarizer		90					
25	Reference Embodiment 31	Second polarizer	0				36	139	
30		Birefringent layer (II)	A	0	68				-3.02
35		Second quarter-wave plate	NB	45	138				2.91
		VA liquid crystal cell				433			
		First quarter-wave plate	NB	135	138				2.91
		First polarizer		90					
40	Reference Embodiment 32	Second polarizer	0				34	133	
45		Birefringent layer (II)	A	0	68				-3.02
50		Second quarter-wave plate	NB	45	138				2.91
		VA liquid crystal cell				364			
		First quarter-wave plate	NB	135	138				2.91
		First polarizer		90					

[0113]

55

EP 2 383 604 A1

[Table 11]

	Optical components	Material	Angle [°]	Retardation [nm]		Nz coefficient	Evaluation results		
				R	Rth or Rlc		CR (45,60)	CR (0,60)	
5	Reference Embodiment 33	Second polarizer	0				29	177	
10		Birefringent layer (II)	A	0	85				-0.83
15		Second quarter-wave plate	NB	45	138				2.08
20		VA liquid crystal cell				290			
		First quarter-wave plate	NB	135	138				2.08
		First polarizer		90					
25	Reference Embodiment 34	Second polarizer	0				31	176	
30		Birefringent layer (II)	A	0	85				-1.59
35		Second quarter-wave plate	NB	45	138				2.08
		VA liquid crystal cell				290			
		First quarter-wave plate	NB	135	138				2.08
		First polarizer		90					
40	Reference Embodiment 35	Second polarizer	0				30	175	
45		Birefringent layer (II)	A	0	78				-1.21
50		Second quarter-wave plate	NB	45	138				2.31
		VA liquid crystal cell				310			
		First quarter-wave plate	NB	135	138				2.31
		First polarizer		90					

55

EP 2 383 604 A1

(continued)

	Optical components	Material	Angle [°]	Retardation [nm]		Nz coefficient	Evaluation results		
				R	Rth or Rlc		CR (45,60)	CR (0,60)	
5	Reference Embodiment 36	Second polarizer	0				31	178	
10		Birefringent layer (II)	A	0	78				-1.97
15		Second quarter-wave plate	NB	45	138				2.31
20		VA liquid crystal cell				310			
		First quarter-wave plate	NB	135	138				2.31
		First polarizer		90					
25	Reference Embodiment 37	Second polarizer	0				29	170	
30		Birefringent layer (II)	A	0	74				-1.49
35		Second quarter-wave plate	NB	45	138				2.37
		VA liquid crystal cell				320			
		First quarter-wave plate	NB	135	138				2.37
		First polarizer		90					
40	Reference Embodiment 38	Second polarizer	0				33	172	
45		Birefringent layer (II)	A	0	74				-2.27
50		Second quarter-wave plate	NB	45	138				2.37
		VA liquid crystal cell				320			
		First quarter-wave plate	NB	135	138				2.37
		First polarizer		90					

55

EP 2 383 604 A1

(continued)

	Optical components	Material	Angle [°]	Retardation [nm]		Nz coefficient	Evaluation results		
				R	Rth or Rlc		CR (45,60)	CR (0,60)	
5	Reference Embodiment 39	Second polarizer	0				28	173	
10		Birefringent layer (II)	A	0	70				-1.73
15		Second quarter-wave plate	NB	45	138				2.48
20		VA				340			
25		liquid crystal cell First quarter-wave plate	NB	135	138				2.48
30		First polarizer		90					
35	Reference Embodiment 40	Second polarizer	0				28	177	
40		Birefringent layer (II)	A	0	70				-2.49
45		Second quarter-wave plate	NB	45	138				2.48
50		VA liquid crystal cell				340			
55		First quarter-wave plate	NB	135	138				2.48
60		First polarizer		90					
65	Reference Embodiment 41	Second polarizer	0				30	174	
70		Birefringent layer (II)	A	0	68				-2.63
75		Second quarter-wave plate	NB	45	138				2.91
80		VA liquid crystal cell				400			
85		first quarter-wave plate	NB	135	138				2.91
90		First polarizer		90					

EP 2 383 604 A1

(continued)

	Optical components	Material	Angle [°]	Retardation [nm]		Nz coefficient	Evaluation results		
				R	Rth or Rlc		CR (45,60)	CR (0,60)	
5	Reference Embodiment 42	Second polarizer	0				30	173	
10		Birefringent layer (II)	A	0	68				-3.40
15		Second quarter-wave plate	NB	45	138				2.91
20		VA liquid crystal cell				400			
		First quarter-wave plate	NB	135	138				2.91
		First polarizer		90					

[0114]

[Table 12]

	Optical components	Material	Angle [°]	Retardation [nm]		Nz coefficient	Evaluation results		
				R	Rth or Rlc		CR (45,60)	CR (0,60)	
25	Reference Embodiment 43	Second polarizer	0				32	175	
30		Birefringent layer (II)	A	0	117				-1.21
35		Second quarter-wave plate	NB	45	138				2.08
40		VA liquid crystal cell				290			
45		First quarter-wave plate	NB	135	138				2.08
		First polarizer		90					

50

55

EP 2 383 604 A1

(continued)

	Optical components	Material	Angle [°]	Retardation [nm]		Nz coefficient	Evaluation results		
				R	Rth or Rlc		CR (45,60)	CR (0,60)	
5	Reference Embodiment 44	Second polarizer	0				31	177	
10		Birefringent layer (II)	A	0	53				-1.21
15		Second quarter-wave plate	NB	45	138				2.08
20		VA liquid crystal cell				290			
		First quarter-wave plate	NB	135	138				2.08
		First polarizer		90					
25	Reference Embodiment 45	Second polarizer	0				29	175	
30		Birefringent layer (II)	A	0	109				-1.58
35		Second quarter-wave plate	NB	45					2.31
		VA liquid crystal cell			138	310			
		First quarter-wave plate	NB	135	138				2.31
		First polarizer		90					
40	Reference Embodiment 46	Second polarizer	0				29	177	
45		Birefringent layer (II)	A	0	42				-1.58
50		Second quarter-wave plate	NB	45	138				2.31
		VA liquid crystal cell				310			
		First quarterwave plate	NB	135	138				2. 31
		First polarizer		90					

55

EP 2 383 604 A1

(continued)

	Optical components	Material	Angle [°]	Retardation [nm]		Nz coefficient	Evaluation results		
				R	Rth or Rlc		CR (45,60)	CR (0,60)	
5	Reference Embodiment 47	Second polarizer	0				30	172	
10		Birefringent layer (II)	A	0	110				-1.87
15		Second quarter-wave plate	NB	45	138				2.37
20		VA liquid crystal cell			138	320			
		First quarter-wave plate	NB	135	138				2.37
		First polarizer		90					
25	Reference Embodiment 48	Second polarizer	0				31	172	
30		Birefringent layer (II)	A	0	43				-1.87
35		Second quarter-wave plate	NB	45	138				2.37
		VA liquid crystal cell				320			
		First quarter-wave plate	NB	135	138				2.37
		First polarizer		90					
40	Reference Embodiment 49	Second polarizer	0				29	177	
45		Birefringent layer (II)	A	0	40				-2.10
50		Second quarter-wave plate	NB	45	138				2.48
		VA liquid crystal cell				340			
		First quarter-wave plate	NB	135	138				2.48
		First polarizer		90					

55

EP 2 383 604 A1

(continued)

	Optical components	Material	Angle [°]	Retardation [nm]		Nz coefficient	Evaluation results		
				R	Rth or Rlc		CR (45,60)	CR (0,60)	
5	Reference Embodiment 50	Second polarizer	0				27	177	
10		Birefringent layer (II)	A	0	109				-2.10
15		Second quarter-wave plate	NB	45	138				2.48
20		VA liquid crystal cell				340			
		First quarter-wave plate	NB	135	138				2.48
		First polarizer		90					
25	Reference Embodiment 51	Second polarizer	0				28	174	
30		Birefringent layer (II)	A	0	42				-3.02
35		Second quarter-wave plate	NB	45	138				2.91
		VA liquid crystal cell				400			
		First quarter-wave plate	NB	135	138				2.91
		First polarizer		90					
40	Reference Embodiment 52	Second polarizer	0				31	173	
45		Birefringent layer (II)	A	0	107				-3.02
50		Second quarter-wave plate	NB	45	138				2.91
		VA liquid crystal cell				400			
		First quarter-wave plate	NB	135	138				2.91
		First polarizer		90					

[0115]

55

[Table 13]

	Optical components	Material	Angle [°]	Retardation [nm]		Nz coefficient	Evaluation results	
				R	Rth or Rlc		CR (45,60)	CR (0,60)
Comparative Embodiment 1	Second polarizer		-20				5	40
	TAC film	TAC		1	32			
	Second quarter-wave plate	NB	25	138		1.58		
	VA liquid crystal cell				320			
	First quarter-wave plate	NB	115	138		1.58		
	TAG film	TAC		1	32			
	First polarizer		70					
Comparative Embodiment 2	Second polarizer		0				15	140
	TAC film	TAC		1	32			
	Second quarter-wave plate	A	45	138	-8	-0.01		
	Birefringent layer (III)	NB		2	318			
	VA liquid crystal cell				320			
	First quarter-wave plate	NB	135	138		1.02		
	TAG film	TAC		1	32			
	First polarizer		90					

[0116] The LCD device in each of Embodiments and Reference Embodiments includes a circular polarizing plate composed of a linear polarizing plate (polarizer) and a quarter-wave plate on each side of the LC cell to provide display in CPVA mode. The CPVA devices are effective in improvement of the contrast ratio because the anti-reflection effects can be obtained in addition to the transmittance-improvement effects. According to the anti-reflection in the CPVA LCD devices, the circular polarizing plates inhibits a light beam once having entered the LCD device and then being reflected inside the device, i.e., a reflected light beam by internal reflection, from exiting the LCD device. Accordingly, in CPVA LCD devices, light beams reflected on black matrix, the lines, the electrodes, and the like in the LC cell hardly exit from the LCD devices, and particularly in bright environments, the reduction in contrast ratio of the LCD devices can be prevented.

[0117] Examples of the reflected light beams causing a reduction in contrast ratio of the LCD devices in bright environments include a light beam that has been reflected on the top of the LCD device without entering the device, i.e., a reflected light beam by surface reflection, in addition to the reflected light by internal reflection. According to the CPVA LCD device, the amount of the reflected light beam by the surface reflection has large effects on visibility of the display screen because the reflected light beam by internal reflection is suppressed. Accordingly, by providing the CPVA LCD device with a measure for reducing the reflected light by the surface reflection, the device can provide a very high contrast ratio in bright environments, and a viewer can realize a marked improvement in display qualities.

[0118] The anti-reflection film for suppression of the surface reflection includes one having a multi-layer structure

composed of films with different refractive indices, and one having a surface on which fine protrusions are formed. Particularly, a "moth-eye film", which is one kind of the latter one, has a surface on which many protrusions smaller than a wavelength (380 nm to 780 nm) of a visible light beam are formed, and due to this structure, very excellent effects of suppressing the surface reflection can be exhibited. As shown in Fig. 21(a), a light beam entering the moth-eye film reaches a base material portion 362 through fine protrusions 361 constituting the film surface, and so a region where both of the protrusions and air exist between air and the portion 362 (A-B region in Fig. 21(a)) is regarded as a region with a refractive index intermediate between that of a material constituting the film (about 1.5 if a resin constitutes the film) and that of air (1.0). Specifically, the refractive index in this region continuously and gradually increases by a value shorter than the wavelength of the visible light beam from the refractive index of air in contact with the film surface to the refractive index of the material for the film. As a result, a light beam incident on the moth-eye film does not recognize the air-film interface as an interface of the two with different refractive indices, and reflection of the light beam on the interface can be significantly reduced. According to the moth-eye films, for example, a surface reflectance of a visible light beam can be reduced to about 0.15%.

[0119] The moth-eye films are disposed between two media with different refractive indices to reduce a reflectance of a light beam on the interface therebetween, but in the configuration in Fig. 12, the internal reflection occurring on the inner side of the second polarizer 350 can be suppressed by the circular polarizing plate composed of the second polarizer 350 and the second quarter-wave plate 340. Accordingly, when the configuration in Fig. 12 is provided with a moth-eye film, the film is disposed on the display face side of the second polarizer 350, as in a moth-eye film 360 shown in Fig. 22. When the LCD device includes members such as protective plates and multiple interfaces exist on the display face side of the second polarizer 350, a moth-eye film may be disposed at each interface and preferably disposed at least on the top surface of the LCD device.

[0120] The moth-eye film, specifically, includes a resin film having a surface on which many protrusions each having a substantially conical shape with a height of about 200 nm are formed with a distance between the tops of the cones being about 200 nm.

[0121] Nanoimprint technology may be employed for production of the moth-eye film. Specifically, employed may be a technology of imparting protrusions and recesses in nanometer size (1 μm to 100 μm) of a mold surface on a resin material coated over a substrate. For curing of the resin material in nanoimprint technology, thermal nanoimprint, UV nanoimprint, and the like, may be employed. According to the UV nanoimprint, for example, a mold is pressed against a UV-curable resin film formed on a transparent substrate, and the film is irradiated with UV light, thereby producing a thin film with nanostructures in the inverse shape of the mold on the transparent substrate.

[0122] Roll-to-roll process is better than batch process when nanoimprint technology is used to produce a large number of thin films with a moth-eye structure at a low cost. By use of the roll-to-roll process, thin films with a moth-eye structure can be continuously produced with a mold roller. Such a mold roller include one having nanosized recesses formed on a polished outer circumference surface of a conical or cylindrical aluminum tube by anodization. According to anodization, the nanosized recesses can be formed in a random placement and in a uniform distribution, and seamless structures (moth-eye structures) preferable for continuous production can be formed on a mold roller surface.

[0123] The present application claims priority to Patent Application No. 2009-015927 filed in Japan on January 27, 2009 under the Paris Convention and provisions of national law in a designated State, the entire contents of which are hereby incorporated by reference.

EXPLANATION OF SYMBOLS

[0124]

100: CPVA LCD device
 110: First polarizer
 111: Absorption axis of first polarizer
 120: First quarter-wave plate
 121: Slow axis of first quarter-wave plate
 130: VA LC cell
 140: Second quarter-wave plate
 141: Slow axis of second quarter-wave plate
 150: Second polarizer
 151: Absorption axis of second polarizer
 200: CPVA LCD device
 210: First polarizer
 220: First quarter-wave plate
 230: VA LC cell

- 235: Birefringent layer (III)
- 240: Second quarter-wave plate
- 250: Second polarizer
- 300: CPVA LCD device
- 5 310: First polarizer
- 320: First quarter-wave plate
- 330: VA LC cell
- 335: Birefringent layer (III)
- 340: Second quarter-wave plate
- 10 345: Birefringent layer (II)
- 350: Second polarizer
- 400: CPVA LCD device
- 410: First polarizer
- 420: First quarter-wave plate
- 15 430: VA LC cell
- 440: Second quarter-wave plate
- 445: Birefringent layer (II)
- 450: Second polarizer

20

Claims

1. A liquid crystal display device, comprising in the following order:

25

a first polarizer;
 a first birefringent layer (I);
 a liquid crystal cell including a liquid crystal layer interposed between a pair of substrates facing each other,
 a second birefringent layer (I);
 a birefringent layer (II); and
 30 a second polarizer,
 the first and second birefringent layers (I) each satisfying $n_x > n_y \geq n_z$, having an in-plane retardation of $\lambda/4$,
 and having substantially the same N_z coefficient,
 the birefringent layer (II) satisfying $n_x < n_y \leq n_z$,
 wherein
 35 the first birefringent layer (I) has an in-plane slow axis forming an angle of about 45° with an absorption axis of
 the first polarizer;
 the second birefringent layer (I) has an in-plane slow axis substantially orthogonal to the in-plane slow axis of
 the first birefringent layer (I);
 the second polarizer has an absorption axis substantially orthogonal to the absorption axis of the first polarizer;
 40 the birefringent layer (II) has an in-plane fast axis substantially orthogonal to the absorption axis of the second
 polarizer; and
 the LC cell displays a black screen by aligning liquid crystal molecules in the liquid crystal layer substantially
 vertically to the substrate surface.

45

2. The liquid crystal display device according to Claim 1,
 further comprising at least one birefringent layer (III) satisfying $n_x \approx n_y \geq n_z$ between the first birefringent layer (I)
 and the liquid crystal cell and/or between the liquid crystal cell and the second birefringent layer (I).

50

3. The liquid crystal display device according to Claim 2,
 wherein the liquid crystal display device satisfies the following formulae (1) to (3):

$$1.0 \leq N_z q \leq 2.9 \quad (1)$$

55

$$(169 \text{ nm} \times N_z q - 81 \text{ nm}) - 30 \text{ nm} \leq R_{lc} + R_3 \quad (2)$$

$$R_{lc} + R_3 \leq (169 \text{ nm} \times N_{zq} - 81 \text{ nm}) + 30 \text{ nm} \quad (3),$$

5 where the N_z coefficient of each of the first and second birefringent layers (I) is defined as N_{zq} ;
 a thickness-direction retardation of the liquid crystal cell in a black state is defined as R_{lc} ;
 a sum of a thickness-direction retardation of the at least one birefringent layer (III) disposed between the first
 birefringent layer (I) and the second birefringent layer (I) is defined as R_3 .

10 4. The liquid crystal display device according to Claim 3,
 wherein the liquid crystal display device satisfies the following formulae (4) to (7):

$$(-0.63 \times N_{zq}^2 + 0.56 \times N_{zq} + 0.40) - 0.35 \leq N_{z2} \quad (4)$$

$$N_{z2} \leq (-0.63 \times N_{zq}^2 + 0.56 \times N_{zq} + 0.40) + 0.35 \quad (5)$$

$$20 (43 \text{ nm} \times N_{zq}^2 - 226 \text{ nm} \times N_{zq} + 370 \text{ nm}) - 30 \text{ nm} \leq R_2 \quad (6)$$

$$R_2 \leq (43 \text{ nm} \times N_{zq}^2 - 266 \text{ nm} \times N_{zq} + 370 \text{ nm}) + 30 \text{ nm} \quad (7),$$

25 where an N_z coefficient of the birefringent layer (II) is defined as N_{z2} ; and
 an in-plane retardation of the birefringent layer (II) is defined as R_2 .

30 5. The liquid crystal display device according to Claim 4,
 wherein the liquid crystal display device satisfies $1.40 \leq N_{zq}$.

6. The liquid crystal display device according to any one of Claims 2 to 5,
 wherein the liquid crystal display device satisfies $2.00 < N_{zq}$, where the N_z coefficient of each of the first and second
 birefringent layers (I) is defined as N_{zq} .

35 7. The liquid crystal display device according to Claim 2 or 3,
 wherein the liquid crystal display device satisfies:

$$40 N_{zq} < 1.40;$$

$$- 0.35 \leq N_{z2} \leq 0;$$

45 and

$$108 \text{ nm} \leq R_2 \leq 168 \text{ nm},$$

50 where the N_z coefficient of each of the first and second birefringent layers (I) is defined as N_{zq} ;
 an N_z coefficient of the birefringent layer (II) is defined as N_{z2} ; and
 an in-plane retardation of the birefringent layer (II) is defined as R_2 .

55 8. The liquid crystal display device according to Claim 1,
 wherein the liquid crystal display device is free of a birefringent layer (III) satisfying $n_x \approx n_y \geq n_z$ between the first
 birefringent layer (I) and the liquid crystal cell and between the liquid crystal cell and the second birefringent layer (I).

9. The liquid crystal display device according to Claim 8,

wherein the liquid crystal display device satisfies the following formulae (1), (8), and (9):

$$1.0 \leq Nzq \leq 2.9 \quad (1)$$

$$(169 \text{ nm} \times Nzq - 81 \text{ nm}) - 30 \text{ nm} \leq R1c \quad (8)$$

$$R1c \leq (169 \text{ nm} \times Nzq - 81 \text{ nm}) + 30 \text{ nm} \quad (9),$$

where the Nz coefficient of each of the first and second birefringent layers (I) is defined as Nzq; and a thickness-direction retardation of the liquid crystal cell in a black state is defined as R1c.

10. The liquid crystal display device according to Claim 9,
wherein the liquid crystal display device satisfies the following (4) to (7):

$$(-0.63 \times Nzq^2 + 0.56 \times Nzq + 0.40) - 0.35 \leq Nz2 \quad (4)$$

$$Nz2 \leq (-0.63 \times Nzq^2 + 0.56 \times Nzq + 0.40) + 0.35 \quad (5)$$

$$(43 \text{ nm} \times Nzq^2 - 226 \text{ nm} \times Nzq + 370 \text{ nm}) - 30 \text{ nm} \leq R2 \quad (6)$$

$$R2 \leq (43 \text{ nm} \times Nzq^2 - 266 \text{ nm} \times Nzq + 370 \text{ nm}) + 30 \text{ nm} \quad (7),$$

where an Nz coefficient of the birefringent layer (II) is defined as Nz2; and an in-plane retardation of the birefringent layer (II) is defined as R2.

11. The liquid crystal display device according to Claim 10,
wherein the liquid crystal display device satisfies $1.40 \leq Nzq$.

12. The liquid crystal display device according to Claim 8 or 9,
wherein the liquid crystal display device satisfies:

$$Nzq < 1.40;$$

$$-0.35 \leq Nz2 \leq 0;$$

and

$$108 \text{ nm} \leq R2 \leq 168 \text{ nm},$$

where the Nz coefficient of each of the first and second birefringent layers (I) is defined as Nzq; an Nz coefficient of the birefringent layer (II) is defined as Nz2; and an in-plane retardation of the birefringent layer (II) is defined as R2.

13. The liquid crystal display device according to any one of Claims 8 to 12,
wherein the liquid crystal display device satisfies $2.00 \leq Nzq$, where the Nz coefficient of each of the first and second birefringent layers (I) is defined as Nzq.

Fig. 1

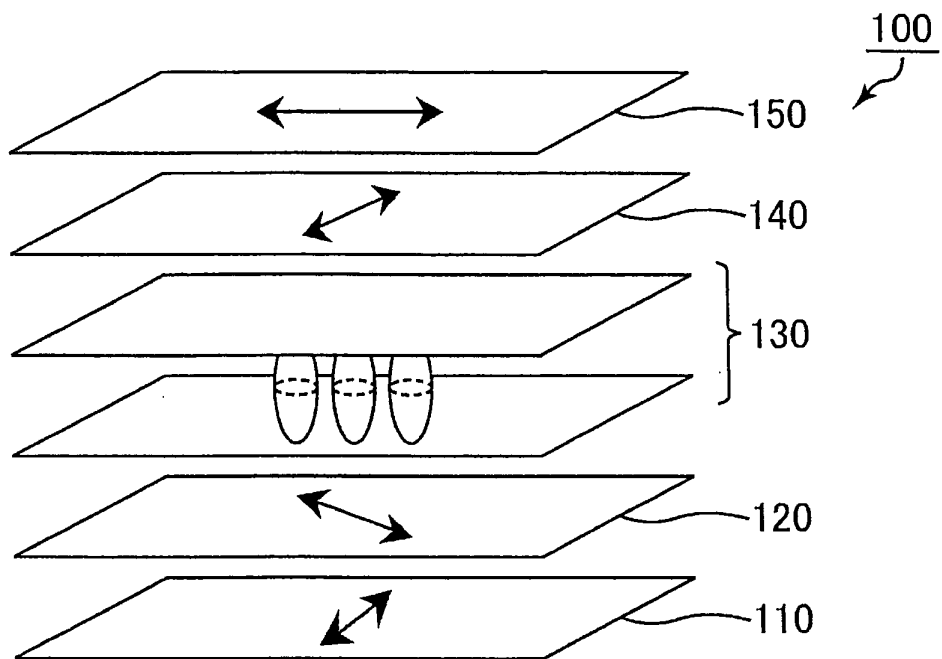
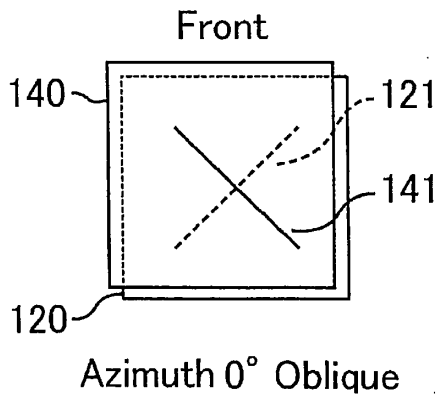
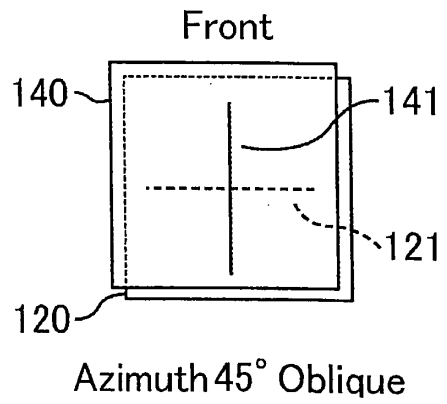

Fig. 2

(a)



(b)



(c)

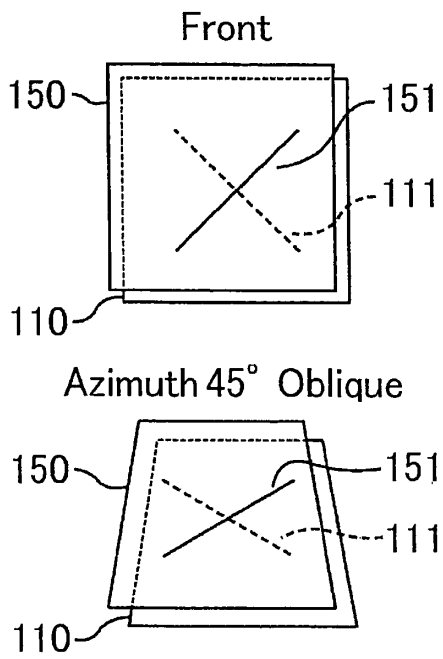

Fig. 3

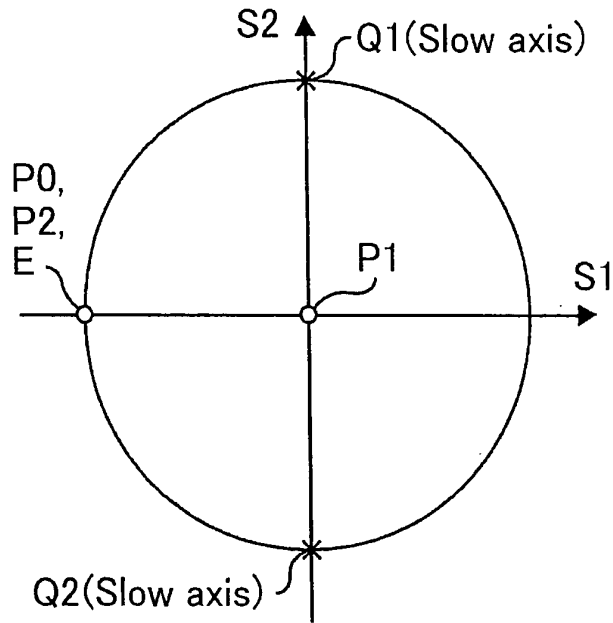

Fig. 4

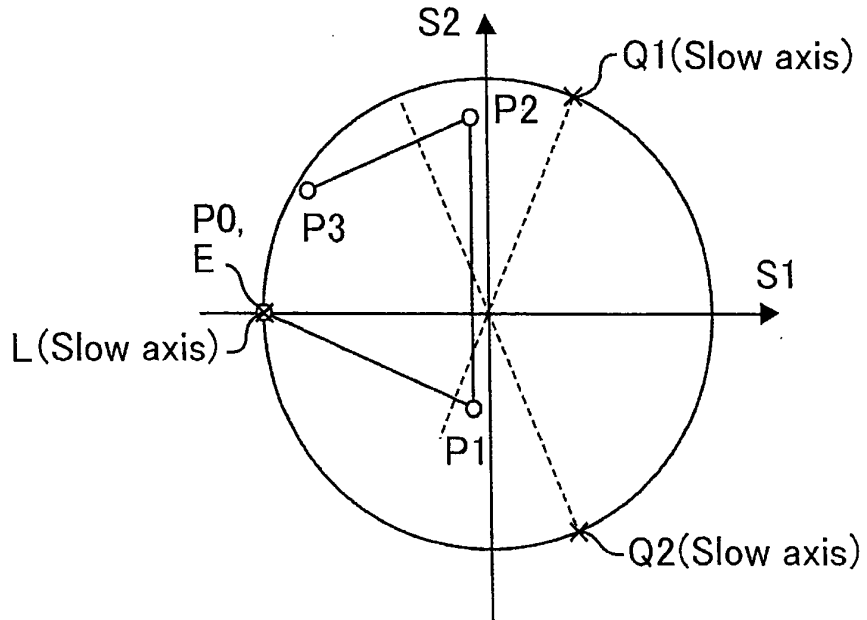

Fig. 5

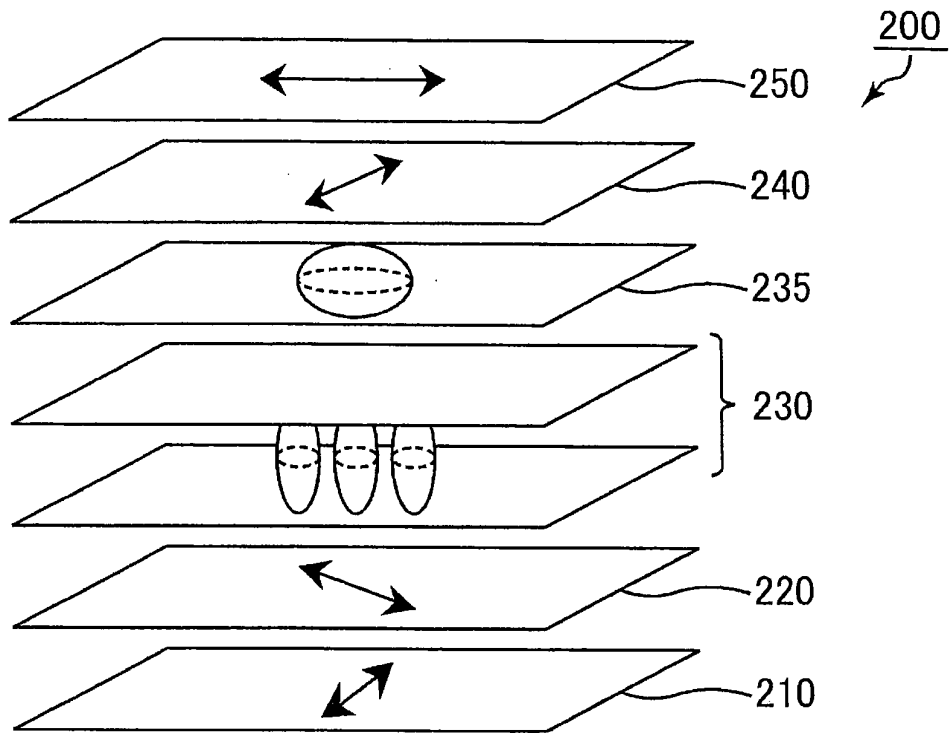

Fig. 6

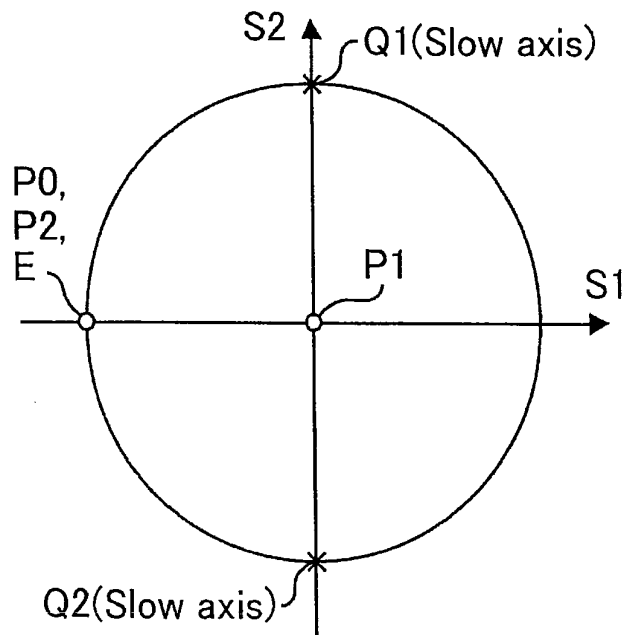

Fig. 7

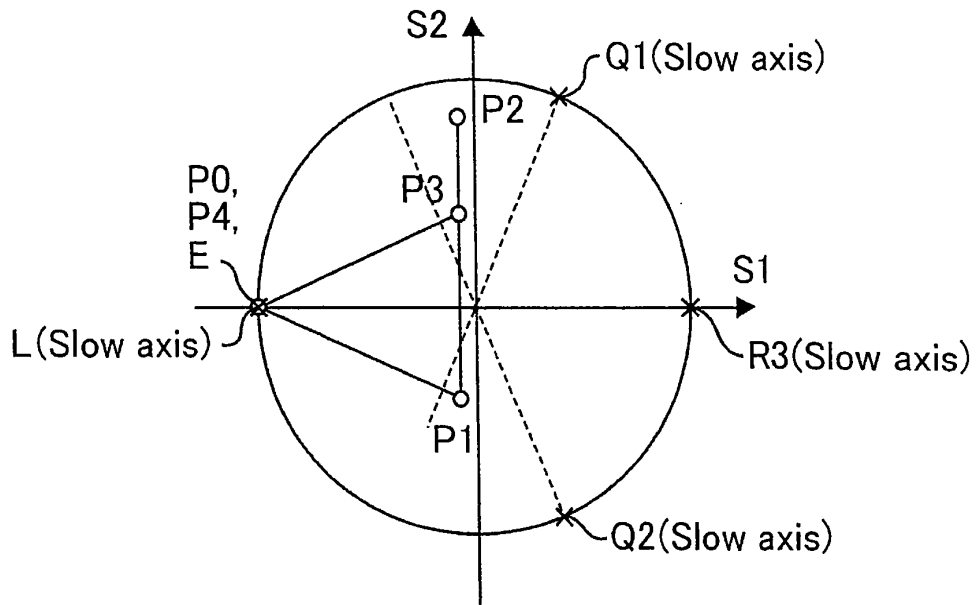

Fig. 8

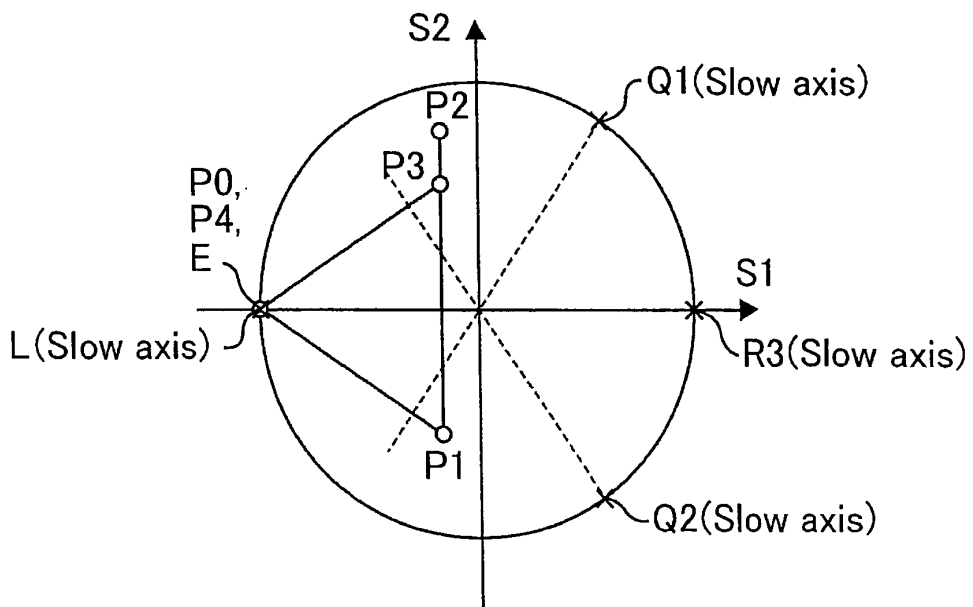

Fig. 9

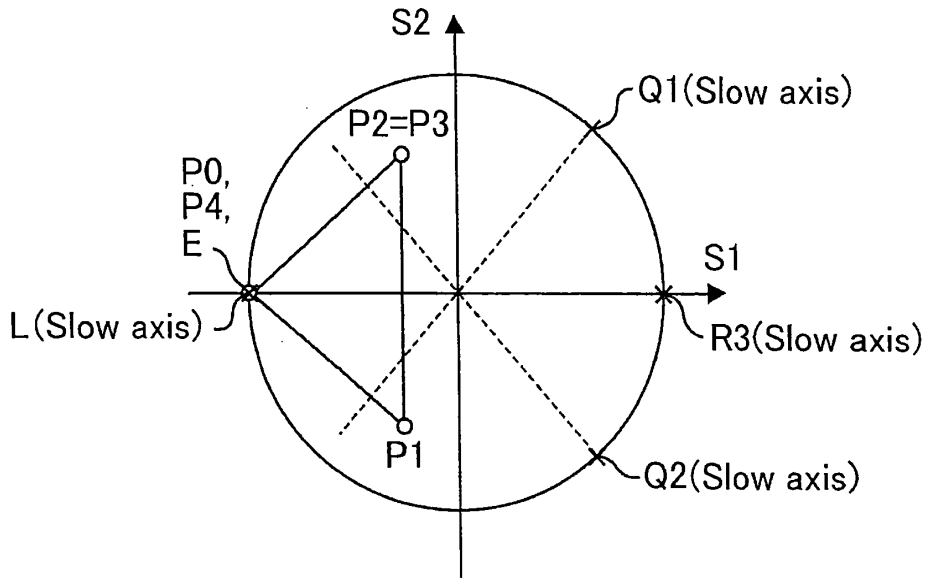

Fig. 10

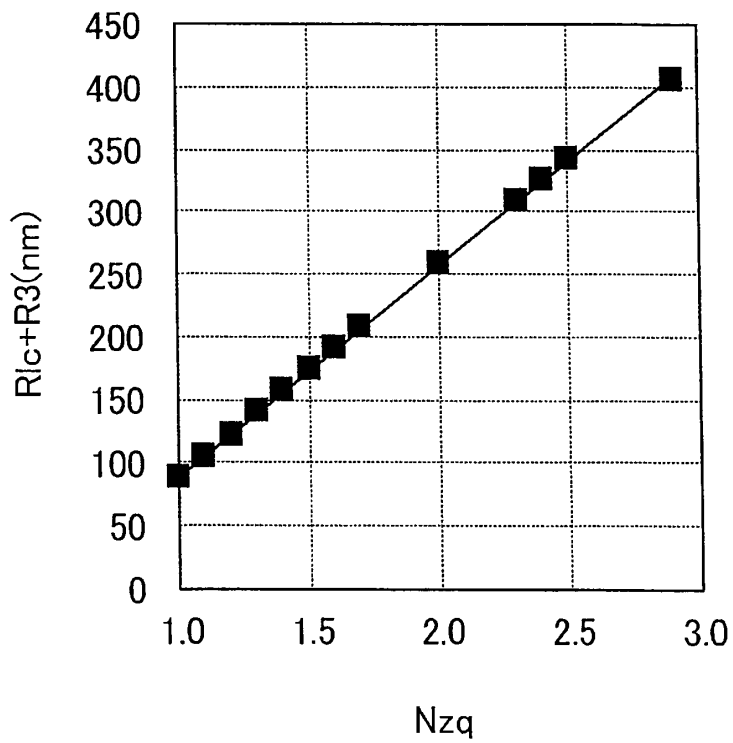

Fig. 11

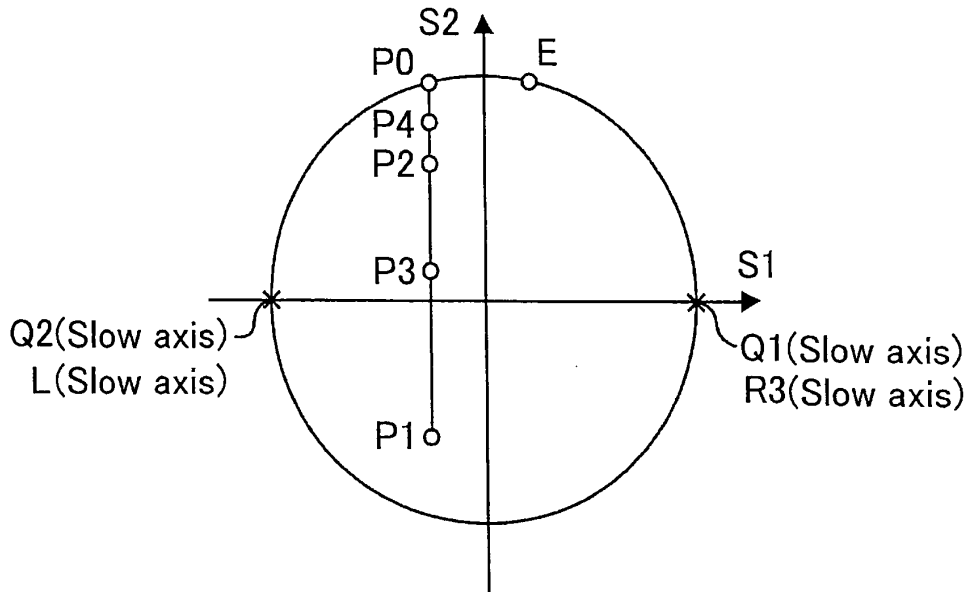

Fig. 12



Fig. 13

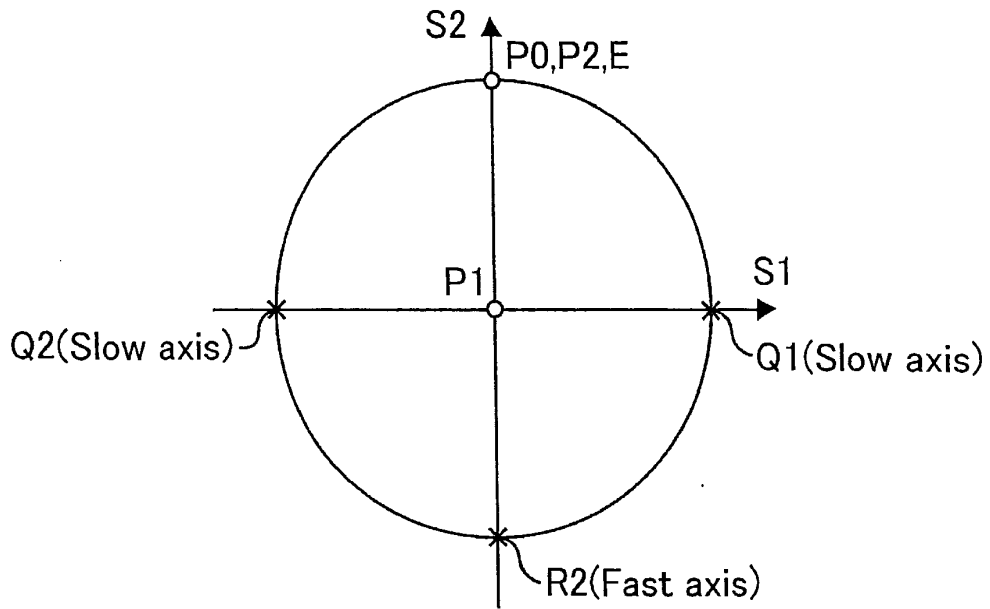

Fig. 14

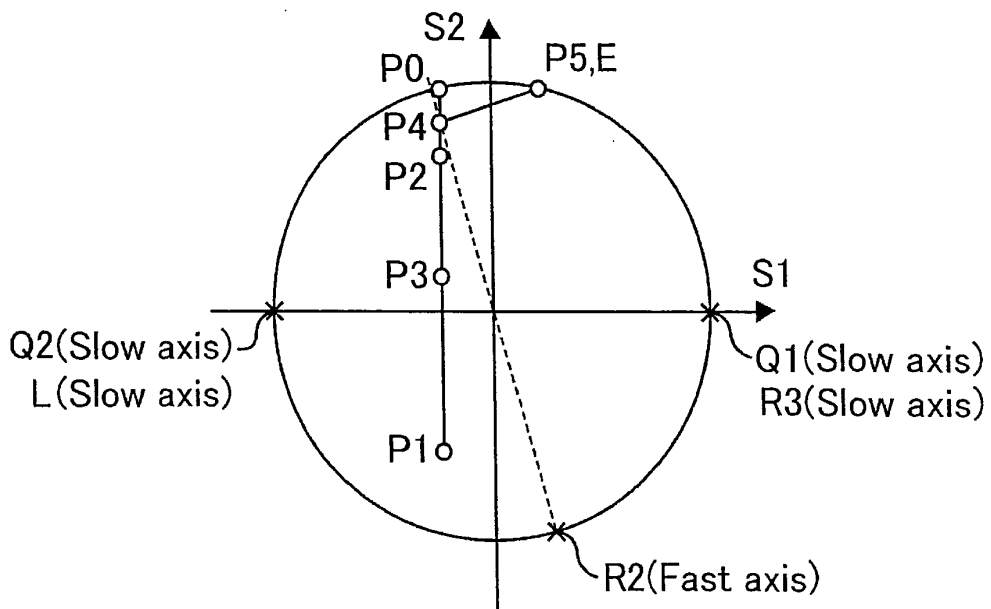

Fig. 15

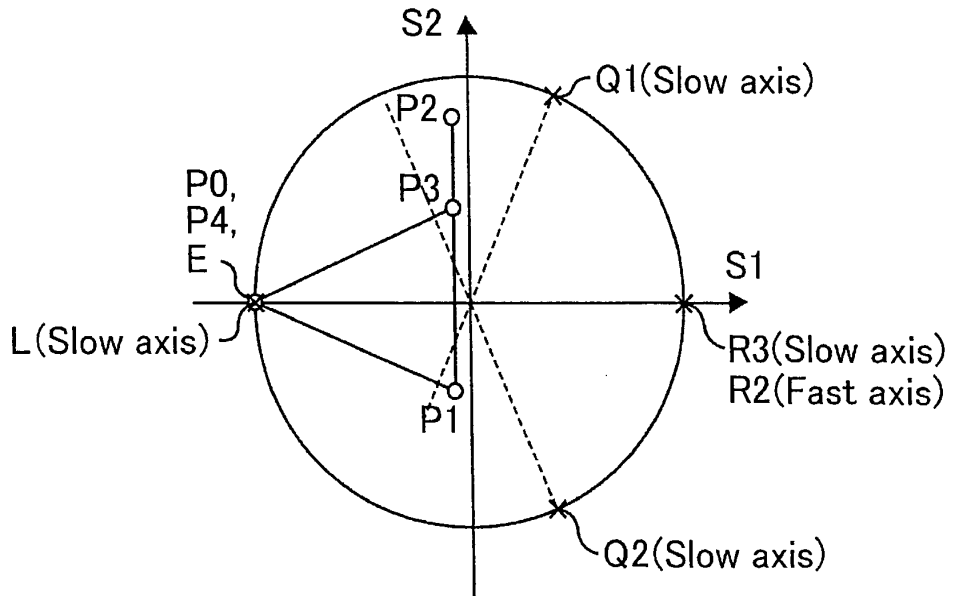

Fig. 16

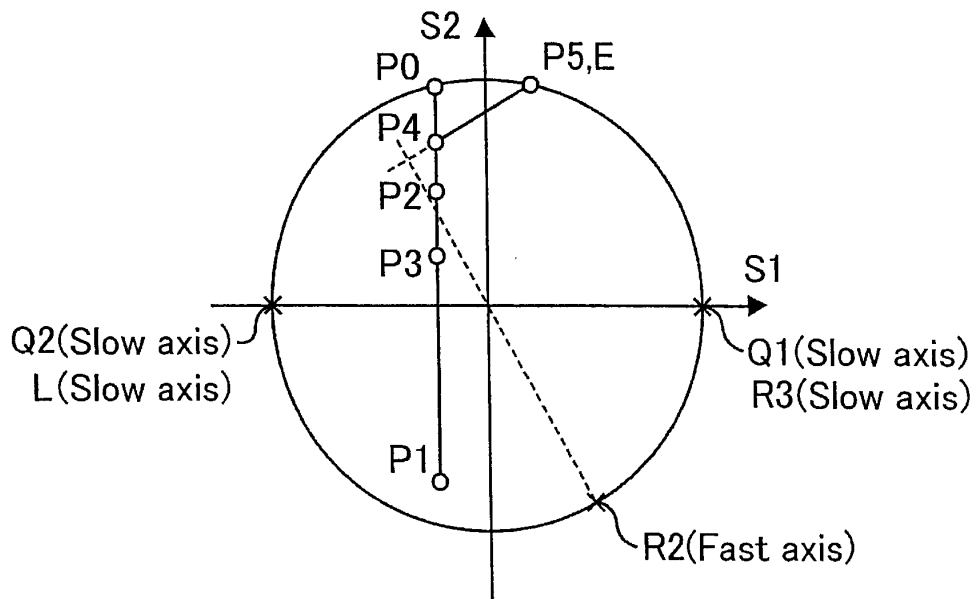

Fig. 17

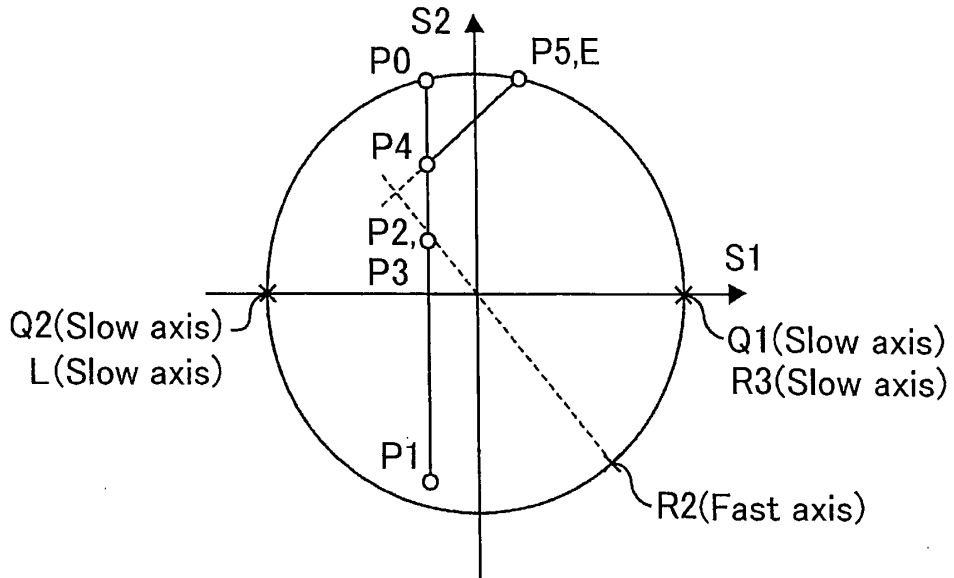

Fig. 18

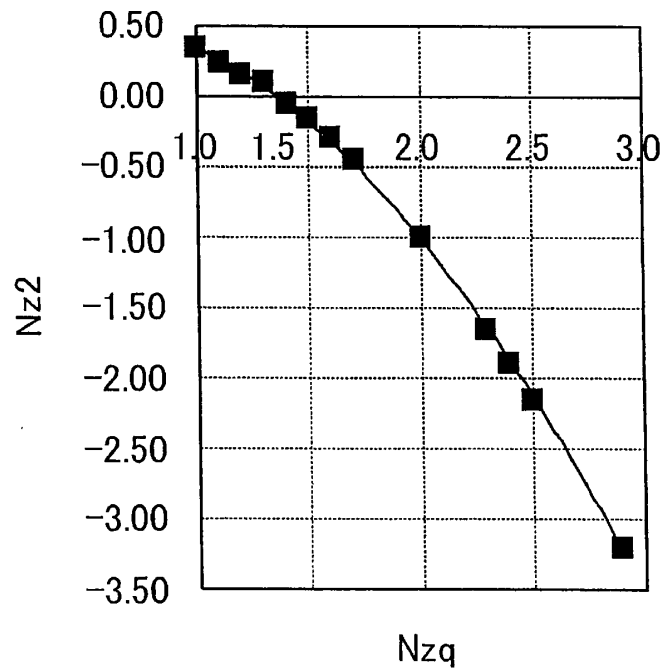

Fig. 19

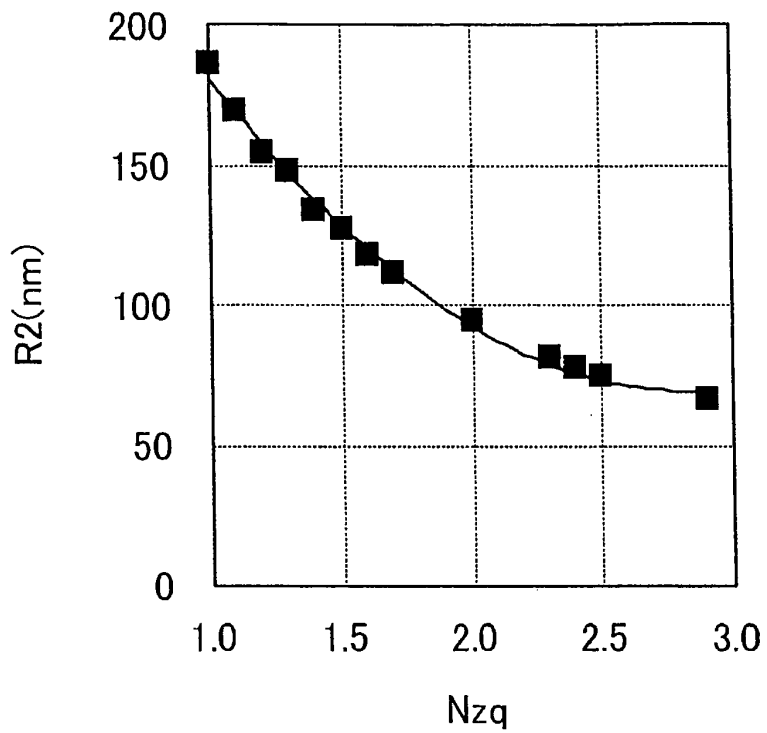

Fig. 20

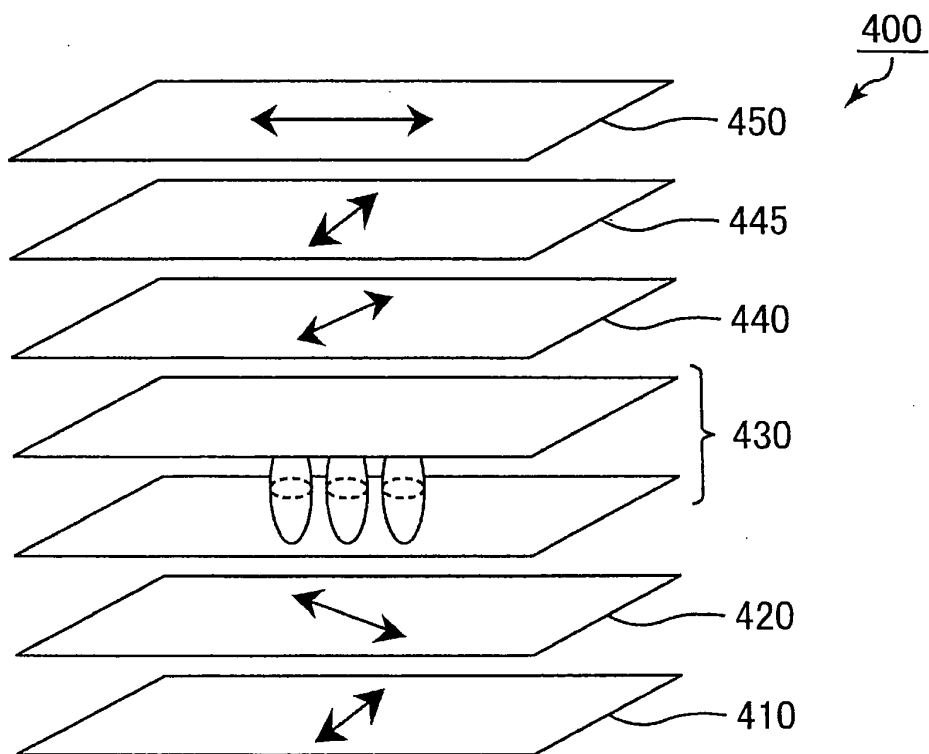

Fig. 21

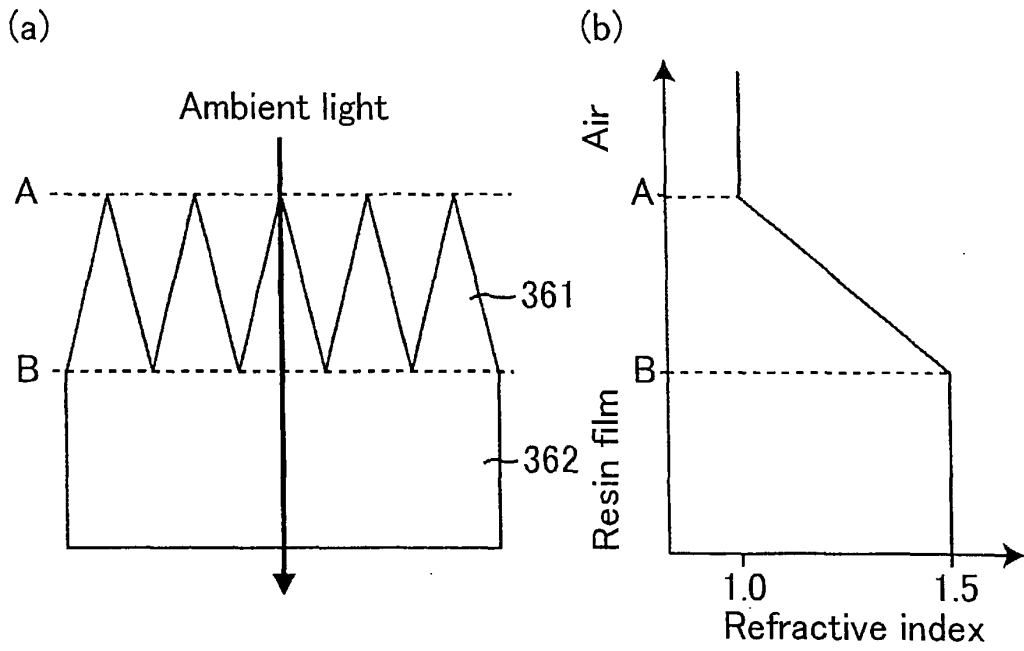
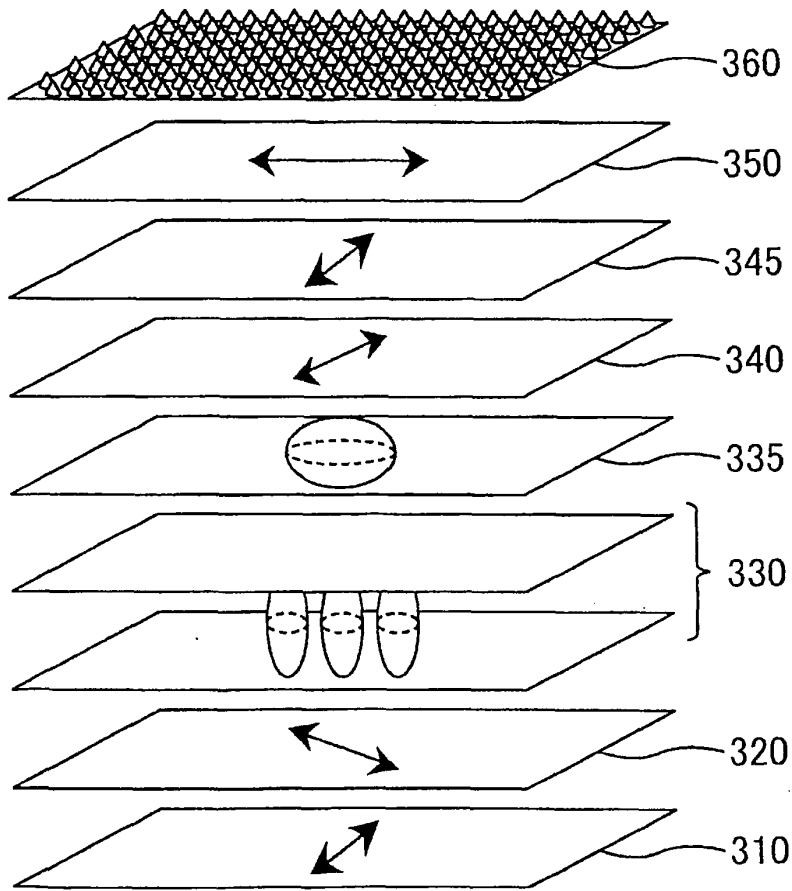

Fig. 22



INTERNATIONAL SEARCH REPORT

International application No.

PCT/JP2009/067660

A. CLASSIFICATION OF SUBJECT MATTER G02F1/13363(2006.01) i		
According to International Patent Classification (IPC) or to both national classification and IPC		
B. FIELDS SEARCHED		
Minimum documentation searched (classification system followed by classification symbols) G02F1/13363		
Documentation searched other than minimum documentation to the extent that such documents are included in the fields searched Jitsuyo Shinan Koho 1922-1996 Jitsuyo Shinan Toroku Koho 1996-2009 Kokai Jitsuyo Shinan Koho 1971-2009 Toroku Jitsuyo Shinan Koho 1994-2009		
Electronic data base consulted during the international search (name of data base and, where practicable, search terms used)		
C. DOCUMENTS CONSIDERED TO BE RELEVANT		
Category*	Citation of document, with indication, where appropriate, of the relevant passages	Relevant to claim No.
X A	JP 2006-251050 A (Toshiba Matsushita Display Technology Co., Ltd.), 21 September 2006 (21.09.2006), entire text; fig. 1 to 17 & US 2006/0203162 A1	1, 2, 7, 8, 12 3-6, 9-11, 13
A	WO 2008/001582 A1 (Sharp Corp.), 03 January 2008 (03.01.2008), entire text; fig. 1 to 9 & JP 2009-110005 A & EP 2042894 A1 & US 2009/0096970 A & KR 10-2009-0028574 A & CN 101473253 A	1-13
<input type="checkbox"/> Further documents are listed in the continuation of Box C. <input type="checkbox"/> See patent family annex.		
* Special categories of cited documents: "A" document defining the general state of the art which is not considered to be of particular relevance "E" earlier application or patent but published on or after the international filing date "L" document which may throw doubts on priority claim(s) or which is cited to establish the publication date of another citation or other special reason (as specified) "O" document referring to an oral disclosure, use, exhibition or other means "P" document published prior to the international filing date but later than the priority date claimed "T" later document published after the international filing date or priority date and not in conflict with the application but cited to understand the principle or theory underlying the invention "X" document of particular relevance; the claimed invention cannot be considered novel or cannot be considered to involve an inventive step when the document is taken alone "Y" document of particular relevance; the claimed invention cannot be considered to involve an inventive step when the document is combined with one or more other such documents, such combination being obvious to a person skilled in the art "&" document member of the same patent family		
Date of the actual completion of the international search 04 December, 2009 (04.12.09)		Date of mailing of the international search report 15 December, 2009 (15.12.09)
Name and mailing address of the ISA/ Japanese Patent Office		Authorized officer
Facsimile No.		Telephone No.

REFERENCES CITED IN THE DESCRIPTION

This list of references cited by the applicant is for the reader's convenience only. It does not form part of the European patent document. Even though great care has been taken in compiling the references, errors or omissions cannot be excluded and the EPO disclaims all liability in this regard.

Patent documents cited in the description

- JP 2002040428 A [0009]
- JP 2003207782 A [0009]
- JP 2003186017 A [0009]
- JP 2008099526 A [0012]
- JP 2008146003 A [0094]
- JP 2009015927 A [0123]

Non-patent literature cited in the description

- **Zhibing Ge.** Wide-View Circular Polarizers for Mobile Liquid Crystal Displays. *IDRC08*, 2008, 266-268 [0010]
- **Takasaki Hiroshi.** Kessyo Kogaku. Morikita Publishing Co., Ltd, 1975, 146-163 [0044]

专利名称(译)	液晶显示装置		
公开(公告)号	EP2383604A1	公开(公告)日	2011-11-02
申请号	EP2009839247	申请日	2009-10-09
[标]申请(专利权)人(译)	夏普株式会社		
申请(专利权)人(译)	夏普株式会社		
当前申请(专利权)人(译)	夏普株式会社		
[标]发明人	SAKAI AKIRA		
发明人	SAKAI, AKIRA		
IPC分类号	G02F1/13363		
优先权	2009015927 2009-01-27 JP		
其他公开文献	EP2383604A4 EP2383604B1		
外部链接	Espacenet		

摘要(译)

本发明提供一种液晶显示装置，其在宽视角下具有更高的对比度并且可以以低成本容易地制造。本发明是一种液晶显示装置，包括以下顺序：第一偏振器；第一个四分之一波长板 ($n_x > n_y \geq n_z$)；液晶盒；第二四分之一波长板，其 N_z 系数与第一四分之一波长板的 N_z 系数基本相同；双折射层 (II) ($n_x < n_y \leq n_z$)；和第二偏振器，其中第一双折射层 (I) 具有与第一偏振器的吸收轴形成约 45° 角的面内慢轴；第二双折射层 (I) 具有与第一双折射层 (I) 的面内慢轴基本正交的面内慢轴；第二偏振器具有与第一偏振器的吸收轴基本垂直的吸收轴；双折射层 (II) 的面内快轴与第二偏振片的吸收轴大致正交。LC单元通过使液晶层中的液晶分子与基板表面基本垂直地对准而显示黑屏。

Fig. 12

