

(19)



(11)

EP 2 071 554 B1

(12)

EUROPEAN PATENT SPECIFICATION

(45) Date of publication and mention of the grant of the patent:
18.07.2012 Bulletin 2012/29

(51) Int Cl.:
G09G 3/36^(2006.01) G09G 3/34^(2006.01)
G09G 3/20^(2006.01)

(21) Application number: **07807639.5**

(86) International application number:
PCT/JP2007/068275

(22) Date of filing: **20.09.2007**

(87) International publication number:
WO 2008/038568 (03.04.2008 Gazette 2008/14)

(54) **LIQUID CRYSTAL DISPLAY DEVICE**
FLÜSSIGKRISTALLANZEIGEEINRICHTUNG
DISPOSITIF D’AFFICHAGE À CRISTAUX LIQUIDES

(84) Designated Contracting States:
AT BE BG CH CY CZ DE DK EE ES FI FR GB GR HU IE IS IT LI LT LU LV MC MT NL PL PT RO SE SI SK TR

- **NAKAMURA, Kozo**
Kashiba-shi, Nara 639-0222 (JP)
- **MIYAZAKI, Akiko**
Uji-shi, Kyoto 611-0041 (JP)
- **TAGUCHI, Tokio**
Yamatokoriyama-shi, Nara 639-1042 (JP)

(30) Priority: **26.09.2006 JP 2006261410**

(43) Date of publication of application:
17.06.2009 Bulletin 2009/25

(74) Representative: **Müller - Hoffmann & Partner**
Patentanwälte
Innere Wiener Strasse 17
81667 München (DE)

(60) Divisional application:
12003871.6

(73) Proprietor: **Sharp Kabushiki Kaisha**
Osaka-shi, Osaka 545-8522 (JP)

(56) References cited:
EP-A- 0 915 363 WO-A-02/101644
WO-A-2005/104084 WO-A-2006/095496
WO-A1-2005/043501 JP-A- 2002 140 038
JP-A- 2003 047 020 JP-A- 2004 109 572
JP-A- 2006 163 047 JP-A- 2007 110 432
US-A1- 2002 063 666 US-B1- 6 300 931

(72) Inventors:
• **UEKI, Shun**
Nara-shi, Nara 630-8014 (JP)

EP 2 071 554 B1

Note: Within nine months of the publication of the mention of the grant of the European patent in the European Patent Bulletin, any person may give notice to the European Patent Office of opposition to that patent, in accordance with the Implementing Regulations. Notice of opposition shall not be deemed to have been filed until the opposition fee has been paid. (Art. 99(1) European Patent Convention).

Description

TECHNICAL FIELD

5 **[0001]** The present invention relates to a liquid crystal display device, and more specifically, to a liquid crystal display device that uses a backlight.

BACKGROUND ART

10 **[0002]** Color display devices such as color television sets and color monitors usually express colors by additive color mixing of primary colors, R, G, and B (red, green, and blue). In color liquid crystal display devices, each pixel has a red sub-pixel, a green sub-pixel, and a blue sub-pixel which correspond to the primary colors R, G, and B, respectively. The luminances of the red, green, and blue sub-pixels are varied to express a diversity of colors. The red, green, and blue sub-pixels are realized by forming three sub-pixel regions within a single pixel region in a color filter.

15 **[0003]** Backlights in conventional liquid crystal display devices have a spectrum as the one illustrated in FIG. 31, and color filter elements which correspond to sub-pixels in conventional liquid crystal display devices have transmittances as the ones illustrated in FIG. 32. In FIG. 32, R, G, and B represent, respectively, transmittances at which color filter elements of red, green, and blue sub-pixels transmit light of varying wavelengths. Liquid crystal display devices display an image (or the like) using light of a given spectrum that is emitted from a backlight, modulated in sub-pixels, and passes through a color filter.

20 **[0004]** FIG.- 33 schematically illustrates a gamut of reproducible colors in a conventional liquid crystal display device. In FIG. 33, R, G, B, Ye, C, M, and W represent, respectively, red, green, blue, yellow, cyan, magenta, and white displayed by a pixel. Red, green, and blue correspond to sub-pixels of the liquid crystal display device and are also called primary colors. Yellow, cyan, and magenta are intermediate colors of the primary colors. The reproducible color gamut is shown as a vectorial sum of vectors to red, green, and blue with black (not shown) as reference, and white is at the center of the vectorial sum. The chromaticity of white is equal to that of black in FIG. 33 for the sake of simplification. A color within the reproducible color gamut may be displayed by setting the luminances of red, green, and blue sub-pixels to arbitrary values.

25 **[0005]** FIG. 34 illustrates chromaticities at which a pixel displays red (R), green (G), blue (B), yellow (Ye), cyan (C), magenta (M), and white (W) in a conventional liquid crystal display device. As illustrated in Table 1, the conventional liquid crystal display device has a reproducible color gamut that is 69% when measured by NTSC ratio, and has a color temperature of 6,600 K.

[0006]

[Table 1]

NTSC ratio	Color temperature
69%	6,600 K

35
40 **[0007]** The color temperature is 6, 600 K in the conventional liquid crystal display device described with reference to FIGS. 31 and 32. A higher color temperature is desired in some cases. For instance, while the standard color temperature according to NTSC is about 6,500 K, the Japanese generally prefer a high color temperature and color television sets for the Japanese market are set to 9, 300 K (see, for example, Non-patent Document 1). A high color temperature liquid crystal display device may be realized by using a backlight that is high in color temperature, namely, a backlight that is high in intensity in the short wavelength region of the visible light spectrum (see, for example, Patent Document 1).

[Non-patent Document 1] Japan Broadcast Publishing Co., Ltd., "Broadcasting Technology Series 2: Broadcasting Formats" 1st Ed., Japan, January 20, 1983, pp. 130-132

[Patent Document 1] JP 2001-228322 A

50 JP-A-2002/ 140038 describes a transmission type image display device with a wide color reproduction range, which is provided with light sources which have different light emission colors, a light source control part which can control those light sources independently, an image detection part which computes and sends an input image signal to the light source control part, a shutter part equipped with color filters of different colors and a shutter control part which controls the shutter part.

55 US-B-6 300 931 discloses a liquid crystal display device with a light source and a light source controlling circuit. The light source controlling circuit changes the intensity output of the light source by varying the supply electric energy. A

converter converts a plurality of input color signals for each color signal according to input-output luminance characteristics which correspond to the plurality of input color signals. A setting part changes the input-output luminance characteristics used by the converter according to the intensity of the light source. The converted color signals are supplied to the plurality of liquid crystal display devices. Thus, color tones disturbed depending on the variation of light emission intensity from the light source are compensated by changing the input-output luminance characteristics used by the converter depending on the fact whether the light source is in a high-intensity state or in a low-intensity state. WO-A-02/101644 discloses a color liquid crystal display in which RGB, yellow and cyan filters are used to produce five primary colors.

DISCLOSURE OF INVENTION

PROBLEMS TO BE SOLVED BY THE INVENTION

[0008] As disclosed in Patent Document 1, a predetermined color temperature may be realized by using a given backlight. However, the inventors of the present application have found out that simply switching to a given backlight shifts the color tone and accordingly lowers the display quality.

[0009] Specifically, in a three-primary color liquid crystal display device, simply employing a backlight that is high in intensity in the short wavelength region (hereinafter, referred to as "high color temperature backlight") shifts the color tone and accordingly lowers the display quality as mentioned above.

[0010] Multi-primary color liquid crystal display devices have also been proposed in which yellow sub-pixels are added to red, green, and blue sub-pixels in order to expand the reproducible color gamut. If a multi-primary color liquid crystal display device uses the same backlight as in a three-primary color liquid crystal display device, the additional yellow sub-pixels give a displayed color a yellowish overtone, which makes the color temperature lower than in a three-primary color liquid crystal display device. A multi-color liquid crystal display device therefore needs to use a backlight that is high in intensity in the short wavelength region (i.e., high color temperature backlight) in order to achieve a color temperature equivalent to that of a three-primary color liquid crystal display device. In this case, too, simply employing a high color temperature backlight shifts the color tone and lowers the display quality.

[0011] The present invention has been made in view of the above-mentioned problems, and an object of the present invention is therefore to provide a liquid crystal display device that achieves a predetermined color temperature while preventing a shift in color tone.

[0012] The above objects are solved by the claimed matter according to the independent claims.

MEANS FOR SOLVING THE PROBLEMS

[0013] In one embodiment, when the pixel displays a color that contains only the blue component, a color that contains only the white component, or a color that contains only the white component and the blue component, the color tone correction section does not make a correction on the luminance of the blue sub-pixel and the luminance of the blue sub-pixel is equal to the original luminance.

[0014] In one embodiment, a maximum luminance of the blue sub-pixel that is set when the pixel displays an arbitrary color containing the at least one predetermined color component is lower than the luminance of the blue sub-pixel that is set when the pixel displays at least one of white and blue.

[0015] In one embodiment, the at least three sub-pixels include a red sub-pixel and a green sub-pixel.

[0016] In one embodiment, the at least three sub-pixels further include a yellow sub-pixel. -

[0017] In one embodiment, the color tone correction section sets a luminance of the yellow sub-pixel to a predetermined value.

[0018] In one embodiment, when the pixel displays a color which is free of a yellow component and which contains at least one color component other than the yellow component, the color tone correction section makes a correction to set the luminance of the blue sub-pixel lower than the original luminance.

[0019] In one embodiment, the at least three sub-pixels further include a cyan sub-pixel.

[0020] In one embodiment, when the pixel displays a color which is free of the yellow component and a cyan component and which contains at least one color component other than the yellow component and the cyan component, the color tone correction section makes a correction to set the luminance of the blue sub-pixel lower than the original luminance.

EFFECTS OF THE INVENTION

[0021] According to the present invention, a liquid crystal display device that achieves a predetermined color temperature while preventing a shift in color tone may be provided.

BRIEF DESCRIPTION OF DRAWINGS

[0022]

5 FIG. 1 is a schematic diagram illustrating a liquid crystal display device of a first embodiment according to the present invention.

FIG. 2 is a schematic diagram illustrating a single pixel in the liquid crystal display device of the first embodiment.

FIG. 3 is a graph illustrating transmittances of color filter elements which correspond to sub-pixels in the liquid crystal display device of the first embodiment.

10 FIG. 4 is a graph illustrating spectra of backlights in a conventional liquid crystal display device and the liquid crystal display device of the first embodiment.

FIG. 5 is a schematic diagram for describing a reproducible color gamut in a liquid crystal display device of Comparative Example 1.

FIG. 6 is a schematic diagram illustrating that a shift in color tone is suppressed in the liquid crystal display device of the first embodiment.

15 FIGS. 7 (a) to 7 (f) are schematic diagrams each illustrating a relation between luminances of sub-pixels that are indicated by an image signal and luminances of the sub-pixels that are indicated by a corrected image signal in the liquid crystal display device of the first embodiment.

FIG. 8(a) is a graph illustrating a change in luminance of a blue sub-pixel that is observed when the pixel color changes from black to blue and then to white in the liquid crystal display device of Comparative Example 1, and

20 FIG. 8(b) is a graph illustrating a change in luminance of the blue sub-pixel that is observed when the pixel color changes from blue to an intermediate color (magenta, for example) and then to white.

FIG. 9(a) is a graph illustrating a change in luminance of the blue sub-pixel indicated by a corrected image signal that is observed when the pixel color changes from black to blue and then to white in the liquid crystal display device of the first embodiment, FIG. 9(b) illustrates, in a manner parallel to the change in FIG. 9(a), changes in R_{in} , G_{in} , B_{in} , b component, w component, and m component that are indicated by an image signal, FIG. 9(c) is a graph illustrating a change in luminance of the blue sub-pixel indicated by a corrected image signal that is observed when the color of the pixel changes from blue to an intermediate color (magenta, for example) and then to white, and FIG.

25 FIG. 9 (d) illustrates, in a manner parallel to the change in FIG. 9(c), changes in R_{in} , G_{in} , B_{in} , b component, w component, and m component that are indicated by an image signal.

FIG. 10(a) is a graph illustrating a change in luminance of the blue sub-pixel that is observed when the pixel color changes from black to blue and then to white in the liquid crystal display device of the first embodiment, and FIGS.

30 FIG. 10 (b) to 10 (d) are graphs each illustrating a change in luminance of the blue sub-pixel indicated by a corrected image signal that is observed when the pixel color changes from blue to an intermediate color (magenta, for example) and then to white.

FIG. 11 is a graph illustrating chromaticities at which a pixel displays red (R), green (G), blue (B), yellow (Ye), cyan (C), magenta (M), and white (W) in liquid crystal display devices of the conventional art, Comparative Example 1, and the first embodiment.

FIG. 12 is a schematic diagram illustrating that the liquid crystal display device of the first embodiment includes a color space conversion unit.

40 FIG. 13 is a schematic diagram illustrating the structure of a color tone correction circuit in the liquid crystal display device of the first embodiment.

FIG. 14 is a schematic diagram illustrating that a shift in chromaticity is suppressed in the liquid crystal display device of the first embodiment.

45 FIG. 15 is a schematic diagram illustrating a single pixel in a liquid crystal display device of a second embodiment according to the present invention.

FIG. 16 is a graph illustrating transmittances of color filter elements which correspond to sub-pixels in the liquid crystal display device of the second embodiment.

FIG. 17 is a graph illustrating spectra of backlights in a conventional liquid crystal display device and the liquid crystal display device of the second embodiment.

50 -FIG. 18 is a graph illustrating chromaticities at which a pixel displays red (R), green (G), blue (B), yellow (Ye), cyan (C), magenta (M), and white (W) in liquid crystal display devices of the conventional art, Comparative Examples 2 and 3, and the second embodiment.

FIGS. 19 (a) to 19 (d) are schematic diagrams each illustrating a relation between luminances of sub-pixels that are indicated by an image signal and luminances of the sub-pixels that are indicated by a corrected image signal in the liquid crystal display device of the second embodiment.

55 FIG. 20 is a schematic diagram illustrating that the liquid crystal display device of the second embodiment includes a color space conversion unit.

FIG. 21 is a schematic diagram illustrating the structure of a color tone correction circuit in the liquid crystal display device of the second embodiment.

FIG. 22 is a schematic diagram for describing which color is favorably suitable to color tone correction in the liquid crystal display device of the second embodiment.

5 FIG. 23 is a graph illustrating chromaticities of pixel colors in liquid crystal display devices of the conventional art, Comparative Example 3, Comparative Example 4, the second embodiment (a) and the second embodiment (b).

FIG. 24 is a schematic diagram illustrating a single pixel in a liquid crystal display device of a third embodiment according to the present invention.

10 FIG. 25 is a graph illustrating transmittances of color filter elements which correspond to sub-pixels in the liquid crystal display device of the third embodiment.

FIG. 26 is a graph illustrating spectra of backlights in a conventional liquid crystal display device and the liquid crystal display device of the third embodiment.

FIG. 27 is a schematic diagram for describing which color is favorably suitable to color tone correction in the liquid crystal display device of the third embodiment.

15 FIG. 28 is a graph illustrating chromaticities at which a pixel displays red (R), green (G), blue (B), yellow (Ye), cyan (C), magenta (M), and white (W) in liquid crystal display devices of Comparative Examples 5 and 6 and the third embodiment.

FIG. 29 is a chromaticity diagram illustrating the chromaticities of sub-pixels in the liquid crystal display devices of the first embodiment and the second embodiment.

20 FIG. 30 is a chromaticity diagram illustrating the chromaticities of sub-pixels in the liquid crystal display device of the third embodiment.

FIG. 31 is a graph illustrating a spectrum of a backlight in a conventional liquid crystal display device.

FIG. 32 is a graph illustrating the transmittances of color filter elements which correspond to sub-pixels in a conventional liquid crystal display device.

25 FIG. 33 is a schematic diagram illustrating a reproducible color gamut in a conventional liquid crystal display device.

FIG. 34 is a graph illustrating chromaticities at which a pixel displays red (R), green (G), blue (B), yellow (Ye), cyan (C), magenta (M), and white (W) in a conventional liquid crystal display device.

DESCRIPTION OF REFERENCE NUMERALS

30 **[0023]**

- 100 liquid crystal display device
- 110 liquid crystal display panel
- 35 120 color tone correction circuit
- 130 backlight
- 140 color space conversion unit

BEST MODE FOR CARRYING OUT THE INVENTION

40 (First embodiment)

[0024] A liquid crystal display device of a first embodiment according to the present invention is described below with reference to the drawings.

45 **[0025]** As illustrated in FIG. 1, a liquid crystal display device 100 of this embodiment includes a liquid crystal display panel 110, which has pixels each defined by three sub-pixels, a color tone correction circuit 120, which corrects a color tone of a color displayed by a pixel, and a backlight 130, which emits, toward the liquid crystal display panel 110, light that brings a color temperature to a predetermined level when a pixel displays white. One pixel 115 in the liquid crystal display panel 110 has three sub-pixels, specifically, a red sub-pixel (R), a green sub-pixel (G), and a blue sub-pixel (B) as illustrated in FIG. 2. The red, green, and blue sub-pixels are realized by forming three sub-pixel regions within a single pixel region in a color filter (not shown). As illustrated in FIG. 2, the red, green, and blue sub-pixels have equal areas.

50 **[0026]** FIG. 3 illustrates transmittances of color filter elements which correspond to the sub-pixels in the liquid crystal display device 100. In FIG. 3, R, G, and B represent, respectively, transmittances at which color filter elements of red, green, and blue sub-pixels transmit light of varying wavelengths. The color filter elements in the liquid crystal display device 100 have the same transmittances as in a conventional liquid crystal display device of FIG. 32.

55 **[0027]** The liquid crystal display device 100 uses a high color temperature backlight as the backlight 130. FIG. 4 illustrates in solid line a spectrum of the high color temperature backlight 130 in the liquid crystal display device 100 and, for reference, illustrates in broken line a spectrum of a backlight in the conventional liquid crystal display device, which

is illustrated in FIG. 31. The backlight 130 uses a light emitting diode (LED). As may be seen in FIG. 4, compared to the backlight in the conventional liquid crystal display device, the spectrum of the high color temperature backlight 130 is high in intensity at a wavelength that corresponds to blue and low in intensity at wavelengths that correspond to red and green. This spectrum change is accomplished by reducing an amount of a yellow-light emitting fluorescent material which absorbs blue light and emits yellow light. In the liquid crystal display device 100 which has a different backlight spectrum than that of the conventional liquid crystal display device as described above, a color displayed by a pixel assumes a more bluish overtone than in the conventional liquid crystal display device, and a high color temperature is thus achieved. The term color temperature used in the following description means, unless otherwise stated, a color temperature that is registered when a liquid crystal display device displays "white". Further, a backlight in a conventional liquid crystal display device is called a conventional backlight in the following description.

[0028] The liquid crystal display device of this embodiment is outlined below in comparison with a liquid crystal display device of Comparative Example 1. First, the liquid crystal display device of Comparative Example 1 is described. The liquid crystal display device of Comparative Example 1 uses the same type of high color temperature backlight as the backlight 130 of the liquid crystal display device 100. The liquid crystal display device of Comparative Example 1 also has the same transmittances of color filter elements as the ones in the liquid crystal display device 100 of this embodiment which are illustrated in FIG. 4. The liquid crystal display device of Comparative Example 1 differs from the liquid crystal display device 100 of this embodiment in that the color tone correction circuit 120 is not provided.

[0029] In FIG. 5, a reproducible color gamut of the liquid crystal display device of Comparative Example 1 is illustrated in solid line and, for reference, a reproducible color gamut of the conventional liquid crystal display device, which is illustrated in FIG. 33, is illustrated in broken line. FIG. 5 places black in the liquid crystal display device of Comparative Example 1 in the same position as that of black in the conventional liquid crystal display device because a color saturation of black is low.

[0030] The spectrum of the high color temperature backlight used in the liquid crystal display device of Comparative Example 1 is high in intensity at a wavelength that corresponds to blue and low in intensity at wavelengths that correspond to red and green, which makes a vector in a blue direction long and vectors in red and green directions short. In the liquid crystal display device of Comparative Example 1, white W' which is expressed by a vectorial sum of the red, green, and blue vectors is accordingly shifted in the blue direction from white W in the conventional liquid crystal display device and, similarly, the reproducible color gamut is shifted in the blue direction from the reproducible color gamut of the conventional liquid crystal display device.

[0031] Now, consider a case in which the maximum-luminance of each sub-pixel is 256, and the liquid-crystal display devices of the conventional art and Comparative Example 1 display magenta at an intermediate luminance with the luminances of the R, G, and B sub-pixels set to $(R, G, B)=(127, 0, 127)$. In FIG. 5, A represents the color displayed by the conventional liquid crystal display device, and A' represents the color displayed by the liquid crystal display device of Comparative Example 1. As may be understood from FIG. 5, the chromaticity of A' in the liquid crystal display device of Comparative Example 1 greatly differs from that of A in the conventional liquid crystal display device and is shifted in the blue direction. FIG. 5 illustrates a color tone shift observed when magenta is displayed, but the color tone shifts in a similar manner also when it is cyan that is displayed. Using a high color temperature backlight in the liquid crystal display device of Comparative Example 1 thus shifts the color tone in the blue direction and hinders proper displaying.

[0032] Next, the liquid crystal display device of this embodiment is described with reference to FIGS. 1 and 6. The liquid crystal display device 100 of this embodiment has the color tone correction circuit 120 as illustrated in FIG. 1. The color tone correction circuit 120 creates, for example, from an image signal which indicates the original luminances of the red, green, and blue sub-pixels, a corrected image signal which indicates luminances that the red', green, and blue sub-pixels should actually present. The luminance of the blue sub-pixel is thus made lower than its original luminance. The image signal may be, for example, input to the color tone correction circuit 120 or created in the color tone correction circuit 120. If the original luminance of the blue sub-pixel that is indicated by the image signal is given as B_{in} and a luminance to be actually presented by the blue sub-pixel (may simply be referred to as "blue sub-pixel luminance") which is indicated by the corrected image signal is given as B_{out} , the color tone correction circuit 120 makes a correction in a manner that sets B_{out} lower than B_{in} .

[0033] For instance, when the image signal indicates that the original luminances of the R, G, and B sub-pixels are $(R, G, B)=(127, 0, 127)$, the color tone correction circuit 120 corrects the image signal so that the blue sub-pixel luminance is, for example, 0.7 times the original luminance thereof, and thus creates the corrected image signal that indicates that the luminances of the R, G, and B sub-pixels are $(R, G, B)=(127, 0, 89)$. This changes the color displayed by the pixel in the liquid crystal display device 100 to A" as illustrated in FIG. 6, thus enabling the liquid crystal display device 100 of this embodiment to display a color that has approximately the same chromaticity as that of the color A displayed by the conventional liquid crystal display device. Owing to a correction made by the color tone correction circuit 120 in the above-mentioned manner in which the blue sub-pixel luminance is set lower than its original luminance, a shift in color tone resulting from the use of a high color temperature backlight may be suppressed.

[0034] The color tone correction circuit 120 corrects the luminance of the blue sub-pixel based on the image signal.

The color tone correction circuit 120 first extracts color components of a pixel color indicated by the image signal. Color components are r (red), g (green), b (blue), ye (yellow), c (cyan), m (magenta), and w (white). The w component is a component whose presence is common to the luminances of the red, green, and blue sub-pixels. Strictly speaking, the w component is a component that represents an achromatic color of the same chromaticity as white and, herein, is also called a white component. The ye component is a component whose presence is common to the luminances of the red and green sub-pixels. The c component is a component whose presence is common to the luminances of the green and blue sub-pixels. The m component is a component whose presence is common to the luminances of the red and blue sub-pixels. The r, g, and b components are components that remain after removing the w, ye, c, and m components from the color components of a pixel color, and that correspond to the luminances of the red, green, and blue sub-pixels, respectively. The color tone correction circuit 120 determines whether to correct the luminance of the blue sub-pixel based on the original luminance of the blue sub-pixel and the color components.

[0035] Bout correction by the color tone correction circuit 120 is described below with reference to Table 2.

[0036]

[Table 2]

	Bin>0	Presence of other color components than b component and w component	Need to correct Bout
Case 1	Yes	Yes	Yes
Case 2	Yes	No	No
Case 3	No	Yes	No

[0037] . As may be understood from Table 2, Bout is corrected when the situation matches Case 1, specifically, when Bin>0 is satisfied and other components than the b component and the w component, namely, any of the r, g, ye, c, and m components is present. Though not illustrated in Table 2, when Bin=0 and no other components than the b component and the w component are present, Rin, Gin, and Bin are all zero and Bout is not corrected.

[0038] Concrete examples of when the color tone correction circuit 120 corrects Bout are described below with reference to FIGS. 7(a) to 7(f). Here, the original luminances of the red, green, and blue sub-pixels which are indicated by the image signal are denoted by Rin, Gin, and Bin, respectively, whereas the luminances of the red, green, and blue sub-pixels that are indicated by the corrected image signal are denoted by Rout, Gout, and Bout, respectively. Rout and Gout are equal to Rin and Gin, respectively. Bout is corrected when the situation matches Case 1, and is not corrected when Case 2 or Case 3 applies. The luminances of each sub-pixel varies within a range between the minimum luminance (which corresponds to, for example, the lowest gray scale level 0) of the sub-pixel and the maximum luminance (which corresponds to, for example, the highest gray scale level 255) of the sub-pixel and, here, the luminances of the respective sub-pixels are expressed in a relative manner.

[0039] As illustrated in FIG. 7 (a), when Rin>Gin>Bin>0, the smallest of the values of Rin, Gin, and Bin (namely, value of Bin) is regarded as the w component and, of Rin-Bin, which is a subtraction of this smallest value from Rin, and Gin-Bin, which is a subtraction of this smallest value from Gin, the smaller one (namely, value of Gin-Bin) is regarded as the ye component. Rin-Gin is regarded as the r component. In this case, Bin>0 is satisfied and the r component and the ye component are present as other components than the b component and the w component. The situation therefore matches Case 1 and the color tone correction circuit 120 corrects Bout.

[0040] As illustrated in FIG. 7(b), when Bin>Rin>Gin>0, the smallest of the values of Rin, Gin, and Bin (namely, value of Gin) is regarded as the w component and, of Rin-Gin, which is a subtraction of this smallest value from Rin, and Bin-Gin, which is a subtraction of this smallest value from Bin, the smaller one (namely, value of Rin-Gin) is regarded as the m component. Bin-Rin is regarded as the b component. In this case, Bin>0 is satisfied and the m component is present as an additional component to the b component and the w component. The situation therefore matches Case 1 and the color tone correction circuit 120 corrects Bout.

[0041] As illustrated in FIG. 7(c), when Gin=Bin=Max (for example, 255) and Rin=0, in other words, when a pixel is to display cyan, Gin and Bin have the same value and this value of Gin or Bin is regarded as the c component. In this case, Bin>0 is satisfied and the c component is present as an additional component to the b component and the w component. The situation therefore matches Case 1 and the color tone correction circuit 120 corrects Bout.

[0042] As illustrated in FIG. 7(d), when Rin=Bin=Max (for example, 255) and Gin=0, in other words, when a pixel is to display magenta, Rin and Bin have the same value and this value of Rin or Bin is regarded as the m component. In this case, Bin>0 is satisfied and the m component is present as an additional component to the b component and the w component. The situation therefore matches Case 1 and the color tone correction circuit 120 corrects Bout.

[0043] As illustrated in FIG. 7 (e) , when Bin>Rin=Gin>0, the smallest of the values of Rin, Gin, and Bin (namely, value of Rin or Gin) is regarded as the w component, and the value of Bin-Gin or Bin-Rin is regarded as the b component. In

this case, $\text{Bin} > 0$ is satisfied but no other components than the b component and the w component are present. Therefore, Case 2 applies and the color tone correction circuit 120 does not correct Bout, which gives Bout the same value as Bin. The luminance of the blue sub-pixel does not need to be corrected when the color components present are only the b component and/or the w component because the color tone is hardly shifted in such cases as may be understood from FIG. 6.

[0044] As illustrated in FIG. 7(f), when $\text{Rin} > \text{Gin} > \text{Bin} = 0$, the smaller one of the values of Rin and Gin (namely, value of Gin) is regarded as the ye component and the value of $\text{Rin} - \text{Gin}$ is regarded as the r component. In this case, $\text{Bin} = 0$ and the r component and the ye component are present as other components than the b component and the w component. Therefore, Case 3 applies and the color tone correction circuit 120 does not correct Bout. Bout is not corrected because Bin is zero and may not be corrected.

[0045] The description returns to the comparison of the liquid crystal display device of this embodiment against the liquid crystal display device of Comparative Example 1. Described first with reference to FIGS. 8 (a) and 8 (b) is a change in blue sub-pixel luminance (Bout) that accompanies a change in pixel color in the liquid crystal display device of Comparative Example 1. The blue sub-pixel luminance (Bout) is the luminance of the blue sub-pixel that is indicated by a signal input to a liquid crystal display panel in the liquid crystal display device of Comparative Example 1. FIG. 8(a) illustrates a change in blue sub-pixel luminance (Bout) that is observed when the pixel color changes from black to blue and then to white. FIG. 8 (b) illustrates a change in blue sub-pixel luminance (Bout) that is observed when the pixel color changes from blue to an intermediate color (for example, magenta) and then to white. Those changes are the same as those in the conventional liquid crystal display device.

[0046] As illustrated in FIG. 8(a), when the pixel color is black, the blue sub-pixel luminance is the minimum luminance. The luminances of the red and green sub-pixels at this point are also the minimum luminance. As the pixel color changes from black to blue, the blue sub-pixel luminance increases. When the pixel color completes the change to blue, the luminance of the blue sub-pixel reaches the maximum luminance. Here, the maximum-luminance is 255 as in the case of the gray scale level. As the pixel color subsequently changes from blue to white, the blue sub-pixel luminance is kept at the maximum luminance whereas the luminances of the red and green sub-pixels increase. When the pixel color completes the change to white, the luminances of the red and green sub-pixels reach the maximum luminance.

[0047] As illustrated in FIG. 8 (b) when the pixel color is blue, the blue sub-pixel luminance is the maximum luminance. The luminances of the red and green sub-pixels at this point are the minimum luminance. As the pixel color changes from blue to magenta, the blue sub-pixel luminance is kept at the maximum luminance whereas the luminance of the red sub-pixel increases. When the pixel color completes the change to magenta, the luminance of the red sub-pixel reaches the maximum luminance. As the pixel color subsequently changes from magenta to white, the luminances of the red and blue sub-pixel are kept at the maximum luminance whereas the luminance of the green sub-pixel increases. When the pixel color completes the change to white, the luminance of the green sub-pixel reaches the maximum luminance.

[0048] Described next with reference to FIGS. 9(a) to 9(d) is a change in blue sub-pixel luminance that accompanies a change in pixel color in the liquid crystal display device of this embodiment. FIG. 9(a) illustrates a change in blue sub-pixel luminance (Bout) indicated by a corrected image signal that is observed when the pixel color changes from black to blue and then to white. FIG. 9(b) illustrates, in a manner parallel to the change in FIG. 9(a), changes in Rin, Gin, Bin, b component, w component, and m component that are indicated by an image signal. FIG. 9(c) illustrates a change in blue sub-pixel luminance (Bout) indicated by a corrected image signal that is observed when the pixel color changes from blue to an intermediate color (magenta, for example) and then to white. FIG. 9(d) illustrates, in a manner parallel to the change in FIG. 9(c), changes in Rin, Gin, Bin, b component, w component, and m component that are indicated by an image signal.

[0049] As illustrated in FIGS. 9(a) and 9 (b), when the pixel color is black, in other words, when Rin, Gin, and Bin are zero, the b component, the w component, and the m component are all zero and Bout is zero (minimum luminance). At this point, the red sub-pixel luminance (Rout) and the blue sub-pixel luminance (Bout), which are indicated by a corrected image signal, are zero as well. As Bin increases while Rin and Gin are kept at zero to change the pixel color from black to blue, the b component increases, thereby increasing Bout. When the pixel color completes the change to blue, in other words, when Bin reaches 255, the b component reaches 255 as well. Bout at this point is 255. As Rin and Gin subsequently increase while Bin is kept at 255, which causes the pixel color to change from blue to white, the b component decreases and the w component increases. Bout at this point remains 255 whereas Rout and Gout increase. When the pixel color completes the change to white, in other words, when Rin, Gin, and Bin reach 255, the b component is zero and the w component is 255. Rout and Gout at this point are 255.

[0050] Thus, when the pixel color changes from black to blue and then to white, $\text{Bin} > 0$ is satisfied all the time except a period in which the pixel color is black, but the pixel color contains only the b component and/or the w component, and no other components, including the m component, are present as may be seen in FIG. 9(b). This case therefore matches Case 2 described above with reference to Table 2, and the color tone correction circuit 120 does not correct Bout. The change illustrated in FIG. 9(a) is the same as that in the conventional liquid crystal display device, which is apparent if FIG. 9(a) is compared against FIG. 8(a).

[0051] As illustrated in FIGS. 9(c) and 9 (d) , when the pixel color is blue, in other words, when Rin and Gin are zero and Bin is 255, the b component is 255 whereas the w component and the m component are zero. Bout at this point is 255. As Rin increases while Bin is kept at 255 to change the pixel color from blue to magenta, the b component decreases and the m component increases. This period, in which Bin>0 is satisfied and the m component is present as an additional component to the w component and the b component, matches Case 1 described above with reference to Table 2, and the color tone correction circuit 120 sets Bout lower than Bin. Accordingly, in the liquid crystal display device 100 of this embodiment, Bout decreases despite no changes in Bin as illustrated in FIG. 9(c). When Rin and Bin reach 255, which causes the pixel color to complete the change to magenta, the b component becomes zero and the m component reaches 255. At this point, with Bin at 255, Bout is, for example, $179 (=255 \times 0.7)$, and Rout is 255.

[0052] As Gin subsequently increases while Rin and Bin are kept at 255 to change the pixel color from magenta to white, the m component decreases and the w component increases. At this point, Gout increases while Rout remains 255. Bout in this period increases as well. When Rin, Gin, and Bin reach 255, which causes the pixel color to complete the change to white, the m-component becomes zero and the w component reaches 255. Gout and Bout at this point reach 255.

[0053] Bout registered when the pixel color is magenta is lower than Bout registered when the pixel color is blue and white, as may be seen in FIG. 9(c) . From a comparison between FIG. 8 (b) and FIG. 9(c), it is understood that the liquid crystal display device 100 of this embodiment differs from the liquid crystal display device of Comparative Example 1 in that Bout is low when the pixel color is magenta, which is an intermediate color between blue and red. The liquid crystal display device 100 may thus suppress the above-mentioned shift in color tone in the blue direction by setting the blue sub-pixel luminance lower than its original luminance when the pixel color is an intermediate color. The blue sub-pixel luminance (Bout) in the liquid crystal display device of Comparative Example 1 which is illustrated in FIGS. 8 (a) and 8 (b) corresponds to the original luminance of the blue sub-pixel (Bin) in the liquid crystal display device 100.

[0054] While Bout registered when the pixel color is blue is equal to Bout registered when the pixel color is white in the description above, the present invention is not limited thereto. As illustrated in FIG. 10 (a), Bout registered when the pixel color is blue may be lower than Bout registered when the pixel color is white. In this case, as may be seen in FIG. 10(b). Bout is an intermediate luminance (179, for example) and Rout and Gout are the minimum luminance when the pixel color is blue, in other words, when Bin is 255. As the pixel color changes from blue to magenta, Rout increases while Bout is kept at the intermediate luminance. When Rin and Bin reach 255 causing the pixel color to complete the change to magenta, Bout is kept at the intermediate luminance whereas Rout reaches 255. As Gin subsequently increases while Rin and Bin are kept at 255 to change the pixel color from magenta to white, Gout increases and Rout remains 255. Bout at this point increases as well. When Rin, Gin, and Bin reach 255, causing the pixel color to complete the change to white, Gout and Bout reach 255.

[0055] While Bout of FIG. 10(b) is kept at an intermediate luminance as the pixel color changes from blue to magenta, the present invention is not limited thereto. As illustrated in FIG. 10 (c) , Bout in a period in which the pixel color changes from blue to magenta may be a decreasing intermediate luminance. Alternatively, in the case where the color temperature is high enough (for example, higher than 6, 500 K) when white is displayed by setting the luminances of all the sub-pixels to the maximum luminance, the blue sub-pixel luminance for displaying white may be set lower than the maximum luminance. In the case where the blue sub-pixel luminance is lower than the maximum luminance when the pixel color is white, Bout registered when the pixel color is blue may be higher than Bout registered when the pixel color is white as illustrated in FIG. 10(d). In those cases, when a pixel displays an arbitrary color containing other color components than the white component and the blue component, the maximum luminance of the blue sub-pixel is lower than a blue sub-pixel luminance at which the pixel displays at least one of white and blue.

[0056] Note that the timing of a change in blue sub-pixel luminance (Bout) that accompanies a change in pixel color is not the sole point of the description given with reference to FIGS. 9 (a) to 9 (d) and FIGS. 10 (a) to 10 (d) . The description given with reference to FIGS. 9 (a) to 9 (d) and FIGS. 10 (a) to 10 (d) is nothing but the algorithm for setting a blue sub-pixel luminance (gray scale level) that is suited to the pixel color. This means that, in the liquid crystal display device of this embodiment, the sub-pixel luminance combinations for displaying the colors illustrated in FIGS. 9(a) to 9 (d) and FIGS. 10(a) to 10(d) are set based on the above-mentioned algorithm. In other words, FIGS. 9 (a) to 9 (d) and FIGS. 10 (a) to 10 (d) do not simply point out the timing at which the blue sub-pixel luminance changes, but indicate the blue sub-pixel luminances themselves that are set to display the colors illustrated in FIGS. 9(a) to 9(d) and FIGS. 10(a) to 10 (d). Bout may be set in advance based on the above-mentioned algorithm, or may be created by calculation. While FIGS. 9(a) to 9(d) and FIGS. 10(a) to 10(d) illustrate the blue sub-pixel luminance for displaying magenta as an intermediate color, the same applies to cases where cyan is displayed as an intermediate color.

[0057] FIG. 11 illustrates chromaticities at which a pixel displays red (R) , green (G), blue (B), yellow (Ye), cyan (C), magenta (M), and white (W) in the liquid crystal display devices of the conventional art, Comparative Example 1, and this embodiment. Here, when a pixel displays cyan and magenta, the blue sub-pixel luminance is set to 0.7 times the original luminance.

[0058] As illustrated in FIG. 11, the chromaticity of white in the liquid crystal display device of Comparative Example

1 is shifted in the blue direction from the chromaticity of white in the conventional liquid crystal display device, and the color temperature is higher in the liquid crystal display device of Comparative Example 1 than in the conventional liquid crystal display device. This is because the liquid crystal display device of Comparative Example 1 uses a high color temperature backlight. However, the chromaticities of cyan and magenta in the liquid crystal display device of Comparative Example 1 are shifted in the blue direction from the ones in the conventional liquid crystal display device, thereby causing a shift from the color tone of the conventional liquid crystal display device.

[0059] In contrast, the liquid crystal display device of this embodiment which sets the blue sub-pixel luminance to 0.7 times the original luminance when a pixel displays cyan and magenta may have approximately the same cyan and magenta chromaticities as those in the conventional liquid crystal display device, despite the use of a high color temperature backlight. The color temperature in the liquid crystal display device of this embodiment is 9,300 K, which is higher than the color temperature (6,600 K) in the conventional liquid crystal display device, as illustrated in Table 3.

[0060]

[Table 3]

	NTSC ratio	Color temperature
Conventional art	69%	6,600 K
First embodiment	69%	9,300 K

[0061] The following description is given on the assumption that signals input to the liquid crystal display device 100 are YCrCb signals, which are commonly used as color television signals. The liquid crystal display device 100 in this case includes, as illustrated in FIG. 12, a color space conversion unit 140, which converts YCrCb signals into RGB signals, and the color tone correction circuit 120 processes the RGB signals obtained through the conversion by the color space conversion unit 140. The color tone correction circuit 120 is mounted to, for example, a substrate of the liquid crystal display panel 110. In the liquid crystal display device 100, the color tone correction circuit 120 creates a corrected image signal which indicates luminances to be actually presented by the red, green, and blue sub-pixels from an image signal which indicates the original luminances of the red, green, and blue sub-pixels.

[0062] The liquid crystal display panel 110 is generally provided with a circuit that performs inverse γ correction (not shown). Inverse γ correction is a correction performed when television signals are used to display an image or the like on a display that is not a CRT or other television tubes in order to make the display's linear luminance characteristics, which differ from CRT characteristics, closer to the CRT characteristics. When the liquid crystal display panel 110 is provided with a circuit that performs inverse γ correction, signals that have received γ correction are input to the liquid crystal display panel 110.

[0063] A specific structure of the color tone correction circuit 120 is described next with reference to FIG. 13. As illustrated in FIG. 13, the color tone correction circuit 120 has an inverse γ correction processing unit 121, a color component extracting unit 122, a signal synthesizing unit 123, a clipping processing unit 124, and a γ correction processing unit 125. The operation of the structural components of the color tone correction circuit 120 is described below. The assumption here is that image signals to be input to the color tone correction circuit 120 after conversion of YCrCb signals have been corrected by γ correction.

[0064] The inverse γ correction unit 121 receives R_{in} , G_{in} , and B_{in} indicating the luminances of the red, green, and blue sub-pixels that have been corrected by γ correction, and performs inverse γ correction to obtain luminances R_0 , G_0 , and B_0 of the red, green, and blue sub-pixels which are pre- γ correction luminances. Whereas the relation between the gray scale level and the luminance is non-linear in the image signal that has been corrected by γ correction, inverse γ correction performed by the inverse γ correction processing unit 121 makes the relation between the gray scale level and the luminance linear. Subsequently, based on the luminances R_0 , G_0 , and B_0 , the color component extracting unit 122 extracts the r, g, b, c, m, ye, and w components from a pixel color indicated by the image signal, and outputs the extracted components to the signal synthesizing unit 123, along with the luminances R_0 , G_0 , and B_0 , which are output as luminances R_1 , G_1 , and B_1 .

[0065] The signal synthesizing unit 123 includes a luminance signal detecting section 123a, a color component detecting section 123b, and a signal correcting section 123c. The luminance signal detecting section 123a determines whether or not the luminance B_1 of the blue sub-pixel is larger than zero. The color component detecting section 123b determines whether or not any of other components than the b and w components, namely, any of the r, g, c, m, and ye components takes a value other than zero. When the luminance signal detecting section 123a detects that the luminance B_1 of the blue sub-pixel is larger than zero and the color component detecting section 123b detects that any of the r, g, c, m, and ye components takes a value other than zero, the signal correcting section 123c calculates the product of the luminance B_1 of the blue sub-pixel and a predetermined value (0.7 to 1) and outputs the result of the calculation as B' . In other cases, the signal correcting section 123c outputs the luminance B_1 of the blue sub-pixel as

B'. The predetermined value is set according to the amount of other color components than the blue component and the white component. For example, the predetermined value is small when the amount of other components than the blue component and the white component is large whereas, when other components than the blue component and the white component are present in a small amount, the predetermined value is large (approaches 1). The signal synthesizing unit 123 outputs R1 and G1 as R' and G', respectively.

[0066] The clipping processing unit 124 performs clipping processing on the luminances R', G', and B' output from the signal synthesizing unit 123. Clipping processing is processing for keeping a luminance within its intended range by preventing the luminance from exceeding the maximum value of the intended range or coming short of the minimum value thereof through conversion to the maximum value or the minimum value. The γ correction processing unit 125 next performs γ correction on R", G", and B", which are obtained through the clipping processing of R', G', and B', and outputs the corrected luminances as Rout, Gout, and Bout to the liquid crystal display panel 110. In the manner as described above, the color tone correction circuit 120 may create a corrected image signal which indicates luminances to be actually presented by the red, green, and blue sub-pixels from an image signal which indicates the original luminances of the red, green, and blue sub-pixels.

[0067] The description above has been given on the assumption that signals input to the liquid crystal display device 100 are YCrCb signals, which are commonly used as color television signals, but are not limited to YCrCb signals. Instead, the input signals may be ones that indicate the luminances of the sub-pixels of the three primary colors R, G, and B, or may be ones that indicate the luminances of the sub-pixels of other three primary colors such as YeMC (Ye: yellow, M: magenta, C: cyan).

[0068] The color tone correction circuit 120 in the description above has the inverse γ correction processing unit 121, which performs inverse γ correction on an image signal that has received γ correction, but the present invention is not limited thereto. If no problem arises in practice, an image signal on which γ correction has been performed may be subjected to the subsequent processing without receiving inverse γ correction and, in this case, the inverse γ correction processing unit 121 may be omitted. Alternatively, the inverse γ correction processing 121 may be omitted in the case where an image signal does not receive γ correction before input to the color tone correction circuit 120.

[0069] The color tone correction circuit 120 in the description above varies the blue sub-pixel luminance with respect to its original luminances in a uniform manner according to the amount of other color components than the b component and the w component. However, the present invention is not limited thereto. The blue sub-pixel luminance may be varied according to a function that sets the blue sub-pixel luminance lower than its original luminance.

[0070] While the sub-pixels have equal areas in the description above, the present invention is not limited thereto. The sub-pixels may have different areas.

[0071] In the description above, the blue sub-pixel luminance is corrected when the pixel color is a color containing any of other color components than the white component and the blue component (namely, r, g, ye, c, and m components). However, the present invention is not limited thereto. The blue sub-pixel luminance may be corrected when a color to be displayed by a pixel contains at least one predetermined color component other than the white component and the blue component. The color tone correction circuit 120 may correct the blue sub-pixel luminance only when the pixel color contains the magenta (m) component or the cyan (c) component because, in the liquid crystal display device of Comparative Example 1, a shift in color tone is particularly large when the pixel color contains the magenta component or the cyan component.

[0072] A pixel in the description above has red, green, and blue sub-pixels, but the present invention is not limited thereto. The sub-pixels in a pixel may employ other color combinations as long as the pixel has a blue sub-pixel.

[0073] In the description above, three cases Case 1 to Case 3 are used as illustrated in Table 2 to determine whether to correct Bout. However, the present invention is not limited thereto. As illustrated in Table 4, Bout may be corrected when the contained color component is not the w component, for example, when the pixel color contains the b component alone. This is particularly effective when the deviation of the chromaticity of white in the liquid crystal display device of this embodiment from a straight - line that connects the chromaticity of white and the chromaticity of blue in the liquid crystal display device of Comparative Example 1 is relatively large. Further, as illustrated in FIG. 14, the chromaticity registered when the blue sub-pixel is at the highest gray scale in the liquid crystal display device of Comparative Example 1 differs from the chromaticity registered when the blue sub-pixel is at the highest gray scale in the conventional liquid crystal display device, and hence setting the blue sub-pixel luminance lower than its original luminance may suppress a shift in color tone in the liquid crystal display device of this embodiment.

[0074]

[Table 4]

	Bin>0	Presence of other color components than w component	Need to correct Bout
Case A	Yes	Yes	Yes

(continued)

	Bin>0	Presence of other color components than w component	Need to correct Bout
Case B	Yes	No	No
Case C	No	No	No

[0075] In Table 4, Bout is not corrected when the only color component of a pixel color is the w component as illustrated in Case B, but the present invention is not limited thereto. A shift in color tone may be suppressed by correcting Bout as long as Bin>0 is satisfied.

[0076] While the color temperature of the liquid crystal display device in the description above is 9,300 K, the present invention is not limited thereto. The color temperature may be adjusted by changing the gamma characteristics (gray scale-luminance characteristics) of respective sub-pixels. For example, the color temperature may be 8,000 K or more and 15,000 K or less.

(Second embodiment)

[0077] A liquid crystal display device of a second embodiment according to the present invention is described below with reference to FIGS. 15 to 23. The liquid crystal display device of this embodiment differs from the liquid crystal display device of the first embodiment in that each pixel has a yellow sub-pixel in addition to the red, green, and blue sub-pixels. The liquid crystal display device 100 of this embodiment has the same structure as that of the above-mentioned liquid crystal display device of the first embodiment, and descriptions on overlapping points are omitted in order to avoid redundancy. However, as described later, the color tone correction-circuit 120 in the liquid crystal display device 100 of this embodiment creates a corrected image signal that indicates the luminances of the red, green, blue, and yellow sub-pixels by correcting the luminance of the blue sub-pixel.

[0078] FIG. 15 illustrates four sub-pixels that are contained within a single pixel in the liquid crystal display device 100 of this embodiment, namely, red (R), green (G), blue (B), and yellow (Ye) sub-pixels. FIG. 16 illustrates the transmittances of color filter elements which correspond to the respective sub-pixels in the liquid crystal display device 100 of this embodiment. In FIG. 16, Ye represents a transmittance at which the color filter element of the yellow sub-pixel transmits light of varying wavelengths. R, G, and B represent transmittances at which the color filter elements of the red, green, and blue sub-pixels transmit light of varying wavelengths, and the transmittances of FIG. 16 are the same as the color filter transmittances of varying wavelengths in the liquid crystal display device of the first embodiment which have been described with reference to FIG. 3.

[0079] The liquid crystal display-device of this embodiment has an expanded reproducible color gamut owing to the inclusion of the yellow sub-pixel in a pixel. However, as described above, adding the yellow sub-pixel gives a color displayed by a pixel a yellowish overtone and lowers the color temperature. The liquid crystal display device of this embodiment therefore achieves a predetermined color temperature by using a high color temperature backlight.

[0080] In FIG. 17, the spectrum of an LED that is used as a backlight in the liquid crystal display device of this embodiment is illustrated in solid line and, for reference, the spectrum of an LED that is used as a backlight in a conventional liquid crystal display device is illustrated in broken line. Note that the backlight in the conventional liquid crystal display device is the same as the one illustrated in FIG. 4.

[0081] FIG. 18 illustrates chromaticities at which a pixel displays red (R), green (G), blue (B), yellow (Ye), cyan (C), magenta (M), and white (W) in liquid crystal display devices of the conventional art, Comparative Examples 2 and 3, and this embodiment. The conventional liquid crystal display device here is the same as the RGB three-primary color liquid crystal display device that has been described with reference to FIG. 11. The liquid crystal display devices of Comparative Examples 2 and 3 are similar to the liquid crystal display device of this embodiment in that a signal that indicates the luminances of four sub-pixels is created from an image signal that indicates the original luminances of the respective sub-pixels in a single pixel includes only the red, green, and blue sub-pixels in Comparative Examples 2 and 3. The liquid crystal display device of Comparative Example 2 differs from the liquid crystal display device of this embodiment in that the blue sub-pixel luminance is not corrected and that the conventional backlight is employed. The liquid crystal display device of Comparative Example 3 differs from the liquid crystal display device 100 of this embodiment in that the blue sub-pixel luminance is not corrected. The liquid crystal display device 100 of this embodiment sets the blue sub-pixel luminance to 0.6 times the original luminance when the pixel displays cyan and magenta.

[0082] Table 5 illustrates Y values and chromaticities x, y at which a pixel displays cyan (C) and magenta (M) in the liquid crystal display devices of the- conventional art, Comparative Examples 2 and 3, and this embodiment.

[0083]

[Table 5]

	C			M		
	Y	x	y	Y	x	y
Conventional art	6.62	0.2291	0.3234	2.63	0.3000	0.1616
Comparative Example 2	4.99	0.2298	0.3241	2.00	0.3006	0.1632
Comparative Example 3	5.10	0.2040	0.2368	2.11	0.2455	0.1157
Second embodiment	4.77	0.2250	0.3034	1.78	0.2915	0.1434

[0084] The display size and resolution of the liquid crystal display device of this embodiment are equal to those of the conventional liquid crystal display device, and the area of a single sub-pixel in the liquid crystal display device of this embodiment is smaller than (3/4 of) the area of a single sub-pixel in the conventional liquid crystal display device. Accordingly, the Y value in the liquid crystal display device of this embodiment is smaller than that in the conventional liquid crystal display device, as illustrated in Table 5.

[0085] As illustrated in FIG. 18, the chromaticity of white in the liquid crystal display device of Comparative Example 2 is shifted in the yellow direction from the chromaticity of white in the conventional liquid crystal display device. This is because the liquid crystal display device of Comparative Example 2 uses a color filter that has an additional yellow sub-pixel.

[0086] The chromaticity of white in the liquid crystal display device of Comparative Example 3 is approximately the same as the chromaticity of white in the conventional liquid crystal display device, and is shifted in the blue direction from the chromaticity of white in the liquid crystal display device of Comparative Example 2. Accordingly, the color temperature in the liquid crystal display device of Comparative Example 3 is higher than that in the liquid crystal display device of Comparative Example 2. This is because the liquid crystal display device of Comparative Example 3 uses a high color temperature backlight. However, the chromaticities of cyan and magenta in the liquid crystal display device of Comparative Example 3 are shifted in the blue direction from the cyan and magenta chromaticities in the liquid crystal display device of Comparative Example 2, and the color tone in the liquid crystal display device of Comparative Example 3 is shifted from the ones in the liquid crystal display devices of the conventional art and Comparative Example 2.

[0087] In contrast, the liquid crystal display device of this embodiment which sets the blue sub-pixel luminance to 0.6 times the original luminance when a pixel displays cyan and magenta may have approximately the same cyan and magenta chromaticities as those in the liquid crystal display devices of the conventional art and Comparative Example 2, despite the use of a high color temperature backlight. The liquid crystal display device of this embodiment may thus suppress a shift in color tone.

[0088] As illustrated in Table 6, the color temperature in the liquid crystal display device of this embodiment is 5,700 K, which is higher than the color temperature (4,400 K) in the liquid crystal display device of Comparative Example 2. Further, in the liquid crystal display device of this embodiment in which each pixel has a yellow sub-pixel, the NTSC ratio is slightly higher than the one in the first embodiment which is illustrated in Table 3.

[0089]

[Table 6]

	NTSC ratio	Color temperature
Comparative Example 2	70%	4,400 K
Second embodiment	71%	5,700 K

[0090] The liquid crystal display device of this embodiment, too, determines whether to correct Bout based on which one of Case 1 to Case 3 applies, as has been described in the first embodiment with reference to Table 2. Bout correction by the color tone correction circuit 120 is described below with reference to FIGS. 19(a) to 19(d) through concrete examples. Here, the luminances of the red, green, and blue sub-pixels that are indicated by an image signal are denoted by Rin, Gin, and Bin, respectively, whereas the luminances of the red, green, blue, and yellow sub-pixels that are indicated by a signal created in the liquid crystal display devices of this embodiment and Comparative Example 3 are denoted by Rout, Gout, Bout, and Yeout, respectively. As described above, a signal that indicates the luminances of the four sub-pixels is created in the liquid crystal display device of Comparative Example 3, but the liquid crystal display device of Comparative Example 3 differs from the liquid crystal display device of this embodiment in that the blue sub-pixel luminance is not corrected. Illustrated in FIGS. 19(a) to 19(d) are results obtained when Yeout is a predetermined value.

[0091] As illustrated in FIG. 19(a), when $Gin > Bin > Rin > 0$ in the liquid crystal display device of this embodiment, the

smallest of the values of R_{in} , G_{in} , and B_{in} (namely, value of R_{in}) is regarded as the w component and, of $G_{in}-R_{in}$, which is a subtraction of this smallest value from G_{in} , and $B_{in}-R_{in}$, which is a subtraction of this smallest value from B_{in} , the smaller one (namely, value of $B_{in}-R_{in}$) is regarded as the c component. The value of $G_{in}-B_{in}$ is regarded as the g component. In this case, $B_{in}>0$ is satisfied and the g component and the c component are present as other components than the b component and the w component. The situation therefore matches Case 1 and the color tone correction circuit 120 makes a correction so that B_{out} is lower than B_{in} .

[0092] As illustrated in FIG. 19(b), when $B_{in}>R_{in}>G_{in}>0$ in the liquid crystal display device of this embodiment, the smallest of the values of R_{in} , G_{in} , and B_{in} (namely, value of G_{in}) is regarded as the w component and, of $R_{in}-G_{in}$, which is a subtraction of this smallest value from R_{in} , and $B_{in}-G_{in}$, which is a subtraction of this smallest value from B_{in} , the smaller one (namely, value of $R_{in}-G_{in}$) is regarded as the m component. The value of $B_{in}-R_{in}$ is regarded as the b component. In this case, $B_{in}>0$ is satisfied and the m component is present as an additional component to the b component and the w component. The situation therefore matches Case 1 and the color tone correction circuit 120 makes a correction so that B_{out} is lower than B_{in} .

[0093] As illustrated in FIG. 19(c), when $G_{in}=B_{in}=\text{Max}$ (for example, 255) and $R_{in}=0$, in other words, when a pixel is to display cyan, G_{in} and B_{in} have the same value and this value of G_{in} or B_{in} is regarded as the c component in the liquid crystal display device of this embodiment. In this case, $B_{in}>0$ is satisfied and the c component is present as an additional component to the b component and the w component. The situation therefore matches Case 1 and the color tone correction circuit 120 makes a correction so that B_{out} is lower than B_{in} .

[0094] As illustrated in FIG. 19(d), when $R_{in}=B_{in}=\text{Max}$ (for example, 255) and $G_{in}=0$, in other words, when a pixel is to display magenta, R_{in} and B_{in} have the same value and this value of R_{in} or B_{in} is regarded as the m component in the liquid crystal display device of this embodiment. In this case, $B_{in}>0$ is satisfied and the m component is present as an additional component to the b component and the w component. The situation therefore matches Case 1 and the color tone correction circuit 120 makes a correction so that B_{out} is lower than B_{in} .

[0095] The following description is given on the assumption that signals input to the liquid crystal display device 100 are YCrCb signals, which are commonly used as color television signals. The liquid crystal display device 100 in this case includes, as illustrated in FIG. 20, the color space conversion unit 140, which converts YCrCb signals into RGB signals, and the color tone correction circuit 120 processes the RGB signals obtained through the conversion by the color space conversion unit 140. In the liquid crystal display device 100 of this embodiment, the color tone correction circuit 120 creates a corrected image signal which indicates the luminances of the red, green, blue, and yellow sub-pixels (R_{out} , G_{out} , B_{out} , and Ye_{out}) from an image signal which indicates the luminances of the respective sub-pixels in a pixel that includes only red, green, and blue sub-pixels (R_{in} , G_{in} , and B_{in}).

[0096] A specific structure of the color tone correction circuit 120 is described next with reference to FIG. 21. As illustrated in FIG. 21, the color tone correction circuit 120 includes the inverse γ correction processing unit 121, the color component extracting unit 122, the signal synthesizing unit 123, the clipping processing unit 124, the γ correction processing unit 125, and selectors 126. The operation of the structural components of the color tone correction circuit 120 is described below.

[0097] The inverse γ correction processing unit 121 receives an image signal which indicates the original luminances of the red, green, and blue sub-pixels, R_{in} , G_{in} , and B_{in} . Here, R_{in} , G_{in} , and B_{in} represent the luminances of the red, green, and blue sub-pixels that have been corrected by γ correction, and pre- γ correction luminances R_0 , G_0 , and B_0 of the red, green, and blue sub-pixels are obtained by performing inverse γ correction on R_{in} , G_{in} , and B_{in} . Based on the luminance R_0 , G_0 , and B_0 , the color component extracting unit 122 extracts the r , g , b , c , m , ye , and w components from a pixel color indicated by the image signal, and outputs the extracted components to the signal synthesizing unit 123, along with the luminances R_0 , G_0 , and B_0 , which are output as luminances R_1 , G_1 , and B_1 . Note that R_{in} , G_{in} , and B_{in} represent the luminance of the sub-pixels when a three-primary color liquid crystal display panel is employed, and R_0 , G_0 , B_0 , R_1 , G_1 , and B_1 which are obtained by processing R_{in} , G_{in} , and B_{in} are the same as when a three-primary color liquid crystal display panel is employed.

[0098] The signal synthesizing unit 123 converts the luminances R_1 , G_1 , and B_1 into the luminances of four primary colors. This conversion is performed, for example, in accordance with a method disclosed in JP 2005-303989 A. The disclosed contents of JP 2005-303989 A are cited herein by reference. Through the above-mentioned conversion, the signal synthesizing unit 123 creates a corrected image signal that indicates the luminances of the red, green, blue, and yellow sub-pixels from an image signal that indicates the luminances of the respective sub-pixels in a pixel including only red, green, and blue sub-pixels.

[0099] The signal synthesizing unit 123 includes the luminance signal detecting section 123a, the color component detecting section 123b, and the signal correcting section 123c. The luminance signal detecting section 123a determines whether or not the luminance B_1 of the blue sub-pixel is larger than zero. The color component detecting section 123b determines whether or not any of other components than the b and w components, namely, any of the r , g , c , m , and ye components takes a value other than zero. When the luminance signal detecting section 123a detects that the luminance B_1 of the blue sub-pixel is larger than zero and the color component detecting section 123b detects that any

of the r, g, c, m, and ye components takes a value other than zero, the signal correcting section 123c calculates the product of the luminance B1 of the blue sub-pixel and a predetermined value (0.6 to 1) and outputs the result of the calculation to the clipping processing unit 124 as B'. In other cases, the signal correcting section 123c outputs the luminance B1 of the blue sub-pixel thereto as B'. The predetermined value is set according to the amount of other color components than the blue component and the white component.

[0100] If necessary, the signal synthesizing unit 123 may set Ye' to a value that is not zero so that, by setting Ye', R1 and G1 are adjusted in a manner that returns a shifted hue to the original hue. The adjusted R1 and G1 are denoted by R' and G'. Note that, in setting Ye' in order to return a shifted hue to the original hue, B' does not need to be adjusted because yellow is the complementary color to blue. The signal synthesizing unit 123 subsequently outputs R', G', and Ye' to the clipping processing unit 124. The signal synthesizing unit 123 performs hue correction processing in the manner as described above.

[0101] The clipping processing unit 124 performs clipping processing on the luminances R', G', B', and Ye' output from the signal synthesizing unit 123. The γ correction processing unit 125 next performs γ correction on R'', G'', B'', and Ye'', which are obtained through the clipping processing of R', G', B', and Ye', and outputs the corrected luminances as Rout, Gout, Bout, and Yeout to the liquid crystal display panel 110.

[0102] The color tone correction circuit 120 in description above corrects the blue sub-pixel luminance to be equal to or larger than 0.6 times the original luminance and smaller than 1.0 times the original luminance. However, the present invention is not limited hereto. The color tone correction circuit 120 may correct the blue sub-pixel luminance to be equal to or larger than 0.4 times the original luminance and smaller than 1.0 times the original luminances.

[0103] In the case where a multi-primary color liquid crystal display panel is employed as the liquid crystal display panel 110, the color tone correction circuit 120 corrects the color tone by correcting the blue sub-pixel luminance in the manner as described above. When it is a three-primary color liquid crystal display panel that is employed as the liquid crystal display panel 110, the color tone correction circuit 120 does not need to correct the color tone. In this case, a switch is made among the selectors 126 so that Rin, Gin, and Bin indicated by the image signal are output as Rout, Gout, and Bout, respectively. In this manner, signal processing may be switched among as many types as the number of the primary colors of the liquid crystal display panel 110.

[0104] As may be understood from the comparison between this embodiment (Second embodiment) and Comparative Example 3 in Table 5, in terms of chromaticities at which magenta and cyan are displayed, this embodiment is closer to the conventional liquid crystal display device than Comparative Example 3 is. In terms of luminance, on the other hand, Comparative Example 3 is closer to the conventional liquid crystal display device than this embodiment, is. In short, in this embodiment, the optimization of the chromaticity is given priority over luminance optimization by lowering the blue sub-pixel luminance from its original luminance. This way, an image having a natural color tone may be displayed without impairing the color appearance of the original image even in a color gamut in which there are no additional sub-pixels.

[0105] In the liquid crystal display device of this embodiment which has an additional yellow sub-pixel, the luminance of the yellow sub-pixel may be set arbitrarily as the need arises as described above, and accordingly the Y value may be increased by setting the luminance of the yellow sub-pixel high.

[0106] What color is favorably suitable to color tone correction in the liquid crystal display device of this embodiment is described below with reference to FIG. 22. FIG. 22 is a chromaticity diagram showing a schematic reproducible color gamut in the liquid crystal display device of this embodiment. In FIG. 22, R, G, B, and Ye correspond to the red, green, blue, and yellow sub-pixels, and W corresponds to white. This diagram, too, illustrates the chromaticity of white as equal to the chromaticity of black. In FIG. 22, gye represents a range in which the green component and the yellow component are the main components, and r, g, b, ye, c, and m each represents a color component that constitutes one of the main components in a range in question.

[0107] The liquid crystal display device of this embodiment has a yellow sub-pixel in addition to the sub-pixels of a common three-primary color liquid crystal display device. Therefore, when a pixel displays a color containing the yellow component, in other words, when a color within the gye and rye ranges illustrated in FIG. 22 is displayed, the luminances of the red sub-pixel and the green sub-pixel may be set lower than their original luminances while the lowered luminances are supplemented by the yellow sub-pixel. The blue sub-pixel luminance in this case may be equal to its original luminance. In other words, when a pixel displays a color that does not contain the yellow component and that contains at least one color component that is other than the yellow component (typically cyan and magenta), the color tone correction circuit 120 (see FIG. 20) may make a correction to set the blue sub-pixel luminance lower than its original luminance. By thus lowering the blue sub-pixel luminance when a color that does not contain the yellow component is displayed, a high color temperature is achieved and the backlight of the display device may be manufactured from a fluorescent material that has excellent luminance efficiency and mass-producibility. As a result, a fine quality image may be displayed at low cost without losing the brightness.

[0108] FIG. 23 illustrates chromaticities at which a pixel displays red (R), green (G), blue (B), yellow (Ye), cyan (C), magenta (M), and white (W) in the liquid crystal display devices of the conventional art and Comparative Example 3.

FIG. 23 also illustrates chromaticities at which a pixel displays cyan (C) and magenta (M) in liquid crystal display devices of this embodiment (a), this embodiment (b), and Comparative Example 4. "Second embodiment (a)" of FIG. 23 is similar to "second embodiment" shown in FIG. 18 and illustrates the result of setting the blue sub-pixel luminance to 0.7 times the original luminance when a pixel displays magenta and cyan. "Second embodiment (b)" of FIG. 23 illustrates the result of setting the blue sub-pixel luminance to 0.7 times the original luminance and multiplying the luminance of the yellow sub-pixel by 1.1 when a pixel displays magenta and cyan. The liquid crystal display device of "conventional art" of FIG. 23 illustrates the same result that is illustrated by the liquid crystal display device of "conventional art" of FIG. 18. The liquid crystal display device of "Comparative Example 4" of FIG. 23 illustrates the result of multiplying the luminance of the yellow sub-pixel by 1.1 without correcting the blue sub-pixel luminance when a pixel displays

[0109]

[Table 7]

	C			M		
	Y	x	y	Y	x	y
this embodiment (a)	4.85	0.2184	0.2826	1.87	0.2895	0.1490
this embodiment (b)	5.51	0.2345	0.2991	2.53	0.2911	0.1667

[0110] As may be understood from a comparison between Tables 5 and 7 and from FIG. 23, this embodiment (b) prevents a reduction in sub-pixel area from lowering the Y value and optimizes the pixel luminance by multiplying the luminance of the yellow sub-pixel by 1.1 in addition to setting the blue sub-pixel luminance to 0.7 times the original luminance. This embodiment (b) thus brings the chromaticities of cyan and magenta closer to the cyan and magenta chromaticities in the conventional liquid crystal display device, and a shift in color tone may be suppressed as a result.

[0111] As seen from Comparative Example 4 of FIG. 23, increasing the luminance of the yellow sub-pixel without lowering the blue sub-pixel luminance causes a rapid change in chromaticity toward white. It is therefore preferable for the color tone correction circuit 120 to give priority to lowering the blue sub-pixel luminance over increasing the luminance of the yellow sub-pixel.

(Third embodiment)

[0112] A liquid crystal display device of a third embodiment according to the present invention is described below with reference to FIGS. 24 to 28. The liquid crystal display device- of this embodiment differs from the liquid crystal display device of the second embodiment in that each pixel has a cyan sub-pixel in addition to the red, green, blue, and yellow sub-pixels. The liquid crystal display device of this embodiment has the same structure as that of the above-mentioned liquid crystal display device of the second embodiment, and descriptions on overlapping points are omitted in order to avoid redundancy.

[0113] FIG. 24 illustrates five sub-pixels that are contained within a single pixel in a liquid crystal display device 100 of this embodiment, namely, red (R), green (G), blue (B), yellow (Ye), and cyan (C) sub-pixels. FIG. 25 illustrates transmittances of color-filter elements which correspond to the sub-pixels in the liquid crystal display device 100 of this embodiment. In FIG. 25, C represents a transmittance at which the color filter element of the cyan sub-pixel transmits light of varying wavelengths. R, G, B, and Ye represent transmittances at which the color filter elements of the red, green, blue, and yellow sub-pixels transmit light of varying wavelengths, and the transmittances of FIG. 25 are the same as the color filter transmittances of varying wavelengths in the red, green, blue, and yellow sub-pixels which have been described with reference to FIG. 16.

[0114] In the liquid crystal display device of this embodiment, too, as in the second embodiment, owing to the inclusion of the yellow sub-pixel in a pixel, a color displayed by a pixel gives a yellowish overtone and lowers the color temperature. The liquid crystal display device of this embodiment therefore achieves a predetermined color temperature by using a high color temperature backlight.

[0115] FIG. 26 illustrates the spectra of backlights in the liquid crystal display device of this embodiment and a three-primary color liquid crystal display device. The backlights used here are cold cathode fluorescent lamps (CCFLs). In FIG. 26, the spectrum of the CCFL in the liquid crystal display device of this embodiment is illustrated in solid line, and the spectrum of the CCFL used as the backlight in the three-primary color liquid crystal display device is illustrated in broken line. The three-primary color CCFL is fabricated so as to suit RGB three-primary color liquid crystal display devices. As is understood from FIG. 26, the spectrum of the CCFL in this embodiment is such that the intensity at a wavelength corresponding to blue is higher than the one in the three-primary color CCFL, whereas the intensities at wavelengths corresponding to red and green are lower than the ones in the three-primary color CCFL.

[0116] What color is favorably suitable to color tone correction in the liquid crystal display device of this embodiment is described below with reference to FIG. 27. FIG. 27 is a chromaticity diagram showing a schematic reproducible color gamut in the liquid crystal display device of this embodiment.

[0117] The liquid crystal display device of this embodiment has a yellow sub-pixel and a cyan sub-pixel in addition to the sub-pixels of a common three-primary color liquid crystal display device. Therefore, when a color within the gye and rye ranges illustrated in FIG. 27 is displayed, the luminances of the red sub-pixel and the green sub-pixel may be set lower than their original luminances while the lowered luminances are supplemented by the yellow sub-pixel, and when a color within the bc and gc ranges illustrated in FIG. 27 is displayed, the luminances of the blue sub-pixel and the green sub-pixel may be set lower than their original luminances while the lowered luminances are supplemented by the cyan sub-pixel. The blue sub-pixel luminance in this case may be equal to its original luminance. In other words, when a pixel displays a color that does not contain the yellow component and the cyan component and that contains at least one color component that is other than the yellow component and the cyan component (typically magenta), the color tone correction circuit 120 (see FIG. 20) may make a correction to set the blue sub-pixel luminance lower than its original luminance. By thus lowering the blue sub-pixel luminance when a color that does not contain the yellow component is displayed, a high color temperature is achieved and the backlight of the display device may be manufactured from a fluorescent material that has excellent luminance efficiency and mass-productibility. As a result, a fine quality image may be displayed at low cost without losing the brightness.

[0118] FIG. 28 illustrates chromaticities at which a pixel displays red (R), green (G), blue (B), yellow (Ye), cyan (C), magenta (M), and white (W) in liquid crystal display devices of Comparative Examples 5 and 6, and this embodiment. The liquid crystal display device of Comparative Example 5 differs from the liquid crystal display device of this embodiment in that the blue sub-pixel luminance is not corrected and that a three-primary color CCFL is used as a backlight. The liquid crystal display device of Comparative Example 6 differs from the liquid crystal display device of this embodiment in that the blue sub-pixel luminance is not corrected. Note that the liquid crystal display device of this embodiment sets the blue sub-pixel luminance to 0.5 times the original luminance when the pixel displays cyan and to 0.8 times the original luminance when the pixel displays magenta. Table 8 illustrates Y values and chromaticities x, y at which a pixel displays cyan (C) and magenta (M) in the liquid crystal display devices of the conventional art, Comparative Example 6, and this embodiment. The liquid crystal display device of "conventional art" in Table 8 illustrates the results of using a three-primary color CCFL as a backlight in a conventional three-primary color liquid crystal display device.

[0119]

[Table 8]

	C			M		
	Y	x	y	Y	x	y
Conventional art	6.72	0.1935	0.2620	3.27	0.2888	0.1417
Comparative Example 6	6.55	0.1747	0.1880	2.09	0.2658	0.1276
Third embodiment	6.17	0.1811	0.2152	1.94	0.2873	0.1394

[0120] As illustrated in FIG. 28, the chromaticity of white in the liquid crystal display device of Comparative Example 6 is shifted in the blue direction from the chromaticity of white in the liquid crystal display device of Comparative Example 5, and the color temperature is higher in the liquid crystal display device of Comparative Example 6 than in the liquid crystal display device of Comparative Example 5. This is because the liquid crystal display device of Comparative Example 6 uses a high color temperature backlight. However, the chromaticities of cyan and magenta in the liquid crystal display device of Comparative Example 6 are shifted in the blue direction from the ones in the liquid crystal display device of Comparative Example 5, thereby causing a shift from the color tone of the liquid crystal display device of Comparative Example 5.

[0121] In contrast, since the liquid crystal display device of this embodiment sets the blue sub-pixel luminance to 0.5 times and 0.8 times the original luminance when a pixel displays cyan and magenta, respectively, the liquid crystal display device may have approximately the same cyan and magenta chromaticities as those in the liquid crystal display device of Comparative Example 5, despite the use of a high color temperature backlight.

[0122] The color temperature in the liquid crystal display device of this embodiment is 12,700 K, which is higher than the color temperature (8,600 K) in the liquid crystal display device of Comparative Example 5, as illustrated in Table 9. Also, the liquid crystal display device of this embodiment has yellow and cyan sub-pixels in each pixel in addition to red, green, and blue sub-pixels, and has a higher NTSC ratio than those of the first embodiment and the second embodiment which are illustrated in Tables 3 and 6.

[0123]

[Table 9]

	NTSC ratio	Color temperature
Comparative Example 5	79%	8,600 K
Third embodiment	80%	12,700 K

[0124] As in the liquid crystal display device of the second embodiment described with reference to FIG. 21, the color tone correction circuit 120 in the liquid crystal display device 100 of this embodiment creates a corrected image signal that indicates the luminances of the sub-pixels of five primary colors from an image signal that indicates the original luminances of the sub-pixels of three primary colors.

[0125] In the description above, the blue sub-pixel luminance set when a pixel displays cyan is 0.5 times the original luminance, and the blue sub-pixel luminance set when a pixel displays magenta is 0.8 times the original luminance, but the present invention is not limited thereto. The ratio of the blue sub-pixel luminance set when a pixel displays cyan to the original luminance may be equal to the ratio of the blue sub-pixel luminance set when a pixel displays magenta to the original luminance. However, the ratio of the blue sub-pixel luminance set when a pixel displays magenta is preferably smaller than the ratio of the blue sub-pixel luminance set when a pixel displays cyan because, while the presence of the cyan sub-pixels enables the liquid crystal display device of this embodiment to achieve an appropriate color appearance by increasing the luminance of the cyan sub-pixel despite the lowered blue sub-pixel luminance, the liquid crystal display device of this embodiment does not have a magenta sub-pixel.

[0126] FIGS. 29 and 30 illustrate the spectrum locus and the dominant wavelength. As illustrated in FIG. 29, in the liquid crystal display devices of the first embodiment and the second embodiment, a sub-pixel whose dominant wavelength is 597 nm to less than 780 nm is called a red sub-pixel, a sub-pixel whose dominant wavelength is 558 nm to less than 597 nm is called a yellow sub-pixel, a sub-pixel whose dominant wavelength is 488 nm to less than 558 nm is called a green sub-pixel, and a sub-pixel whose dominant wavelength is 380 nm to less than 488 nm is called a blue sub-pixel.

[0127] As illustrated in FIG. 30, in the liquid crystal display device of the third embodiment, a sub-pixel whose dominant wavelength is 605 nm to less than 635 nm is called a red sub-pixel, a sub-pixel whose dominant wavelength is 565 nm to less than 580 nm is called a yellow sub-pixel, a sub-pixel whose dominant wavelength is 520 nm to less than 550 nm is called a green sub-pixel, a sub-pixel whose dominant wavelength is 475 nm to less than 500 nm is called a cyan sub-pixel, and a sub-pixel whose dominant wavelength is less than 470 nm is called a blue sub-pixel. A comparison between FIG. 29 and FIG. 30 illustrates that the range of the dominant wavelength corresponding to the cyan sub-pixel in the third embodiment partially overlaps with the range of the dominant wavelength corresponding to the green sub-pixel in the first embodiment and the second embodiment.

[0128] The function blocks that the color tone correction circuit 120 has in the liquid crystal display devices 100 of the above-mentioned first to third embodiments, specifically, the inverse γ correction processing unit 121, the color component extracting unit 122, the signal synthesizing unit 123, the clipping processing unit 124, and the γ correction processing unit 125, may be implemented by hardware. Alternatively, some of or all of those functional blocks may be implemented by software.

[0129] In the case where the above-mentioned function blocks are implemented by software, the color tone correction circuit 120 is configured with the use of a computer. This computer has a central processing unit (CPU) for executing various programs, a random access memory (RAM) functioning as a workspace in which those programs are executed, and others. A color tone correction program for implementing the above-mentioned function block is run on the above-mentioned computer, to thereby cause the computer to operate as the function blocks.

[0130] The color tone correction program may be supplied to the computer from a recording medium in which the program is recorded, or may be supplied to the computer over a communication network. The recording medium in which the color tone correction program is recorded may be detachable from the computer, or may be incorporated in the computer. This recording medium may be of a type that is loaded to the computer so that the computer may directly read a recorded program code, or a type that is loaded to be read via a program reading device, which is connected to the computer as external storage.

[0131] Examples of a medium that is employable as the above-mentioned recording medium include tape type media such as magnetic tapes and cassette tapes, disk type media such as magnetic disks (e.g., flexible disks and hard disks) and optical disks (e.g., CD-ROMs, MOs, MDs, DVDs, CD-Rs), card type media such as IC cards (including memory cards) and optical cards, and semiconductor memories such as mask ROMs, erasable programmable read only memories (EPROMs), electrically erasable programmable read only memories (EEPROMs), and Flash ROMs.

[0132] In the case where the above-mentioned color tone correction program is supplied over a communication network, the color tone correction program takes the form of a carrier wave or a data signal string in which a program code of the color tone correction program is embodied through electronic transfer.

[0133] The liquid crystal display device of this embodiment uses five primary colors but the present invention is not limited thereto. The liquid crystal display device may use six primary colors, which are, for example, RGBYeCM, or may be R1GBYeCR2 by the use of red (R2) instead of magenta (M). In this case, R1 and R2 may have the same chromaticity or different chromaticities.

INDUSTRIAL APPLICABILITY

[0134] A liquid crystal display device according to the present invention is favorably applied to, for example, monitors for personal computers, liquid crystal television sets, liquid crystal projectors, and display sections of cellular phones.

Claims

1. A liquid crystal display device (100), comprising:

a liquid crystal display panel (110) which includes a pixel defined by at least three sub-pixels including a blue sub-pixel;
 a high-color temperature backlight (130) which is adapted to emit, toward the liquid crystal display panel (110), light that brings a color temperature to a predetermined level when the pixel displays white; and
 a color tone correction section (120) which is adapted to correct a color tone of a color displayed by the pixel, wherein the color tone correction section (120) is adapted to create a corrected image signal that indicates luminances to be actually presented by the at least three sub-pixels of the pixel of the liquid crystal display panel (110), from an image signal that indicates original luminances of a red sub-pixel, a green sub-pixel and the blue sub-pixel in a pixel that is formed only of the red sub-pixel, the green sub-pixel and the blue sub-pixel, and wherein the color tone correction section (120) includes

a color component extracting unit (122) which is adapted to receive the original luminances of the red sub-pixel, the blue sub-pixel and the green sub-pixel, and a signal synthesizing unit (123).

characterized in that

the color component extracting unit (122) is further adapted to extract color components including a magenta component and a cyan component from a pixel color that is indicated by the image signal and to output the extracted color components and the original luminances of the red sub-pixel, the blue sub-pixel and the green sub-pixel to the signal synthesizing unit (123),

wherein a white component is the smallest luminance value of the original luminances of the red sub-pixel, the blue sub-pixel and the green sub-pixel, and the magenta component is the smallest luminance value of the luminance values of the red sub-pixel and the blue sub-pixel after having subtracted the white component from the original luminances of the red sub-pixel and the blue sub-pixel, and the cyan component is the smallest luminance value of the luminance values of the green sub-pixel and the blue sub-pixel after having subtracted the white component from the original luminances of the green sub-pixel and the blue sub-pixel; and **in that**

the signal synthesizing unit (123) is adapted

- to receive the extracted color components and the original luminances of the red sub-pixel, the green sub-pixel and the blue sub-pixel from the color component extracting unit (122),
- to determine whether or not the original luminance of the blue sub-pixel is larger than zero, and whether or not the pixel color contains the magenta component or the cyan component, and,
- if the original luminance of the blue sub-pixel is larger than zero and the pixel color contains the magenta component or the cyan component, based on the original luminance of the blue sub-pixel, to create the corrected image signal in a manner that makes the luminance to be actually presented by the blue sub-pixel lower than the original luminance, and

if the original luminance of the blue sub-pixel is not larger than zero and/or the pixel color does not contain the magenta component and the cyan component, to create a corrected image signal in a manner that makes the luminance to be actually presented by the blue sub-pixel equal to the original luminance.

2. The liquid crystal display device (100) according to claim 1, **characterized in that** the signal synthesizing unit (123) is adapted to create the corrected image signal in manner that the luminance to be actually presented by the blue sub-pixel is 0.6 times or 0.7 times the original luminance if the original luminance of the blue sub-pixel is larger than

zero and the pixel color contains the magenta component or the cyan component.

3. The liquid crystal display device (100) according to any of claims 1 or 2.
characterized in that the signal synthesizing unit (123) is adapted to create the corrected image signal in a manner that a maximum luminance of the blue sub-pixel that is set when the pixel displays an arbitrary color containing the magenta component or the cyan component is lower than the luminance of the blue sub-pixel that is set when the pixel displays at least one of white and blue corresponding to the highest value of the blue component.
4. The liquid crystal display device (100) according to any of claims 1 through 3,
characterized in that the at least three sub-pixels include a red sub-pixel and a green sub-pixel.
5. The liquid crystal display device (100) according to claim 4,
characterized in that the at least three sub-pixels further include a yellow sub-pixel.
6. The liquid crystal display device according to claim 5.
characterized in that the color tone correction section (120) sets a luminance of the yellow sub-pixel to a predetermined value.
7. The liquid crystal display device (100) according to claim 4 or 5.
characterized in that, when the pixel displays a color which contains a yellow component, the color tone correction section (120) is adapted to create a corrected image signal in a manner that makes the luminance to be actually presented by the blue sub-pixel equal to the original luminance.
8. The liquid crystal display device (100) according to claim 7 or 6,
characterized in that the at least three sub-pixels further include a cyan sub-pixel.

Patentansprüche

1. Flüssigkristallanzeigeeinrichtung (100), mit:
 - einer Flüssigkristallanzeigetafel (110), die ein Pixel enthält, das durch mindestens drei Subpixel, die ein blaues Subpixel enthalten, definiert ist;
 - einer Hintergrundbeleuchtung mit hoher Farbtemperatur (130), die dafür ausgelegt ist, Licht in Richtung der Flüssigkristallanzeigetafel (110) auszusenden, das eine Farbtemperatur auf einen vorgegebenen Pegel bringt, wenn das Pixel Weiß anzeigt; und
 - einem Farbtonkorrekturabschnitt (120), der dafür ausgelegt ist, einen Farbton einer durch das Pixel angezeigten Farbe zu korrigieren, wobei der Farbtonkorrekturabschnitt (120) dafür ausgelegt ist, aus einem Bildsignal, das die Originalhelligkeiten eines roten Subpixels, eines grünen Subpixels und des blauen Subpixels in einem Pixel angibt, das nur aus dem roten Subpixel, dem grünen Subpixel und dem blauen Subpixel gebildet ist, ein korrigiertes Bildsignal zu erzeugen, das die von den mindestens drei Subpixeln des Pixels der Flüssigkristallanzeigetafel (110) tatsächlich darzustellenden Helligkeiten angibt, und wobei der Farbtonkorrekturabschnitt (120) enthält:
 - eine Farbkomponentenextraktionseinheit (122), die dafür ausgelegt ist, die Originalhelligkeiten des roten Subpixels, des blauen Subpixels und des grünen Subpixels zu empfangen, und eine Signalsynthesierungseinheit (123),
dadurch gekennzeichnet, dass
 - die Farbkomponentenextraktionseinheit (122) ferner dafür ausgelegt ist, Farbkomponenten, die eine magentafarbene Komponente und eine blaugüne Komponente enthalten, aus einer Pixelfarbe, die durch das Bildsignal angegeben ist, zu extrahieren und die extrahierten Farbkomponenten und die Originalhelligkeiten des roten Subpixels, des blauen Subpixels und des grünen Subpixels an die Signalsynthesierungseinheit (123) auszugeben,
 - wobei eine weiße Komponente dem kleinsten Helligkeitswert der Originalhelligkeiten des roten Subpixels, des blauen Subpixels und des grünen Subpixels entspricht und die magentafarbene Komponente dem kleinsten Helligkeitswert der Helligkeitswerte des roten Subpixels und des blauen Subpixels nach Abzug der weißen Komponente von den Originalhelligkeiten des roten Subpixels und des blauen Subpixels entspricht und die blaugüne Komponente dem kleinsten Helligkeitswert der Helligkeitswerte des grünen Sub-

pixels und des blauen Subpixels nach Abzug der weißen Komponente von den Originalhelligkeiten des grünen Subpixels und des blauen Subpixels entspricht; und **dadurch**, dass die Signalsynthesierungseinheit (123) dafür ausgelegt ist,

5 - die extrahierten Farbkomponenten und die Originalhelligkeiten des roten Subpixels, des grünen Subpixels und des blauen Subpixels von der Farbkomponentenextraktionseinheit (122) zu empfangen,
 - zu bestimmen, ob die Originalhelligkeit des blauen Subpixels größer als null ist oder nicht, und, ob die Pixelfarbe die magentafarbene Komponente oder die blaugrüne Komponente enthält oder nicht; und
 10 - wenn die Originalhelligkeit des blauen Subpixels größer als null ist und die Pixelfarbe die magentafarbene Komponente oder die blaugrüne Komponente enthält, anhand von der Originalhelligkeit des blauen Subpixels das korrigierte Bildsignal in der Weise zu erzeugen, dass die von dem blauen Subpixel tatsächlich dargestellte Helligkeit kleiner als die Originalhelligkeit ist, und

15 wenn die Originalhelligkeit des blauen Subpixels nicht größer als null ist und/oder die Pixelfarbe die magentafarbene Komponente und die blaugrüne Komponente nicht enthält, das korrigierte Bildsignal in der Weise zu erzeugen, dass die von dem blauen Subpixel tatsächlich dargestellte Helligkeit gleich der Originalhelligkeit ist.

20 2. Flüssigkristallanzeigeeinrichtung (100) nach Anspruch 1, **dadurch gekennzeichnet, dass** die Signalsynthesierungseinheit (123) dafür ausgelegt ist, das korrigierte Bildsignal in der Weise zu erzeugen, dass die durch das blaue Subpixel tatsächlich dargestellte Helligkeit 0,6-mal oder 0,7-mal die Originalhelligkeit ist, wenn die Originalhelligkeit des blauen Subpixels größer als null ist und die Pixelfarbe die magentafarbene Komponente oder die blaugrüne Komponente enthält.

25 3. Flüssigkristallanzeigeeinrichtung (100) nach Anspruch 1 oder 2, **dadurch gekennzeichnet, dass** die Signalsynthesierungseinheit (123) dafür ausgelegt ist, das korrigierte Bildsignal in der Weise zu erzeugen, dass eine Maximalhelligkeit des blauen Subpixels, die festgelegt wird, wenn das Pixel eine willkürliche Farbe, die die magentafarbene Komponente oder die blaugrüne Komponente enthält, anzeigt, niedriger als die Helligkeit des blauen Subpixels ist, die festgelegt wird, wenn das Pixel Weiß und/oder Blau entsprechend dem höchsten Wert der blauen Komponente anzeigt.
 30

4. Flüssigkristallanzeigeeinrichtung (100) nach einem der Ansprüche 1 bis 3, **dadurch gekennzeichnet, dass** die mindestens drei Subpixel ein rotes und ein grünes Subpixel enthalten.

35 5. Flüssigkristallanzeigeeinrichtung (100) nach Anspruch 4, **dadurch gekennzeichnet, dass** die mindestens drei Subpixel ferner ein gelbes Subpixel enthalten.

40 6. Flüssigkristallanzeigeeinrichtung (100) nach Anspruch 5, **dadurch gekennzeichnet, dass** der Farbtonkorrekturabschnitt (120) eine Helligkeit des gelben Subpixels auf einen vorgegebenen Wert setzt.

45 7. Flüssigkristallanzeigeeinrichtung (100) nach Anspruch 4 oder 5, **dadurch gekennzeichnet, dass**, wenn das Pixel eine Farbe anzeigt, die eine gelbe Komponente enthält, die Farbtonkorrekturereinheit (120) dafür ausgelegt ist, ein korrigiertes Bildsignal in der Weise zu erzeugen, die bewirkt, dass die durch das blaue Subpixel tatsächlich dargestellte Helligkeit gleich der Originalhelligkeit ist.

8. Flüssigkristallanzeigeeinrichtung (100) nach Anspruch 7 oder 6, **dadurch gekennzeichnet, dass** die mindestens drei Subpixel ferner ein blaugrünes Subpixel enthalten.

50 **Revendications**

1. Dispositif d'affichage à cristaux liquides (100) comprenant :

55 un panneau d'affichage à cristaux liquides (110) qui inclut un pixel défini par au moins trois sous-pixels incluant un sous-pixel bleu ;
 un rétroéclairage à température de couleur élevée (130) qui est conçu pour émettre, vers le panneau d'affichage à cristaux liquides (110), une lumière qui amène une température de couleur à un niveau prédéterminé lorsque

le pixel affiche du blanc ; et

une section de correction de tonalité chromatique (120) qui est conçue pour corriger une tonalité chromatique d'une couleur affichée par le pixel, dans laquelle la section de correction de tonalité chromatique (120) est conçue pour créer un signal d'image corrigé qui indique des luminances à présenter en réalité par les au moins trois sous-pixels du pixel du panneau d'affichage à cristaux liquides (110), à partir d'un signal d'image qui indique des luminances d'origine d'un sous-pixel rouge, d'un sous-pixel vert et du sous-pixel bleu dans un pixel qui est formé seulement du sous-pixel rouge, du sous-pixel vert et du sous-pixel bleu, et dans lequel la section de correction de tonalité chromatique (120) inclut

une unité d'extraction de composante de couleur (122) qui est conçue pour recevoir les luminances d'origine du sous-pixel rouge, du sous-pixel bleu et du sous-pixel vert, et une unité de synthèse de signal (123),

caractérisé en ce que

l'unité d'extraction de composante de couleur (122) est en outre conçue pour extraire des composantes de couleur incluant une composante magenta et une composante cyan à partir d'une couleur de pixel qui est indiquée par le signal d'Image et pour sortir les composantes de couleur extraites et les luminances d'origine du sous-pixel rouge, du sous-pixel bleu et du sous-pixel vert vers l'unité de synthèse de signal (123), dans lequel une composante blanche est la valeur de luminance la plus petite des luminances d'origine du sous-pixel rouge, du sous-pixel bleu et du sous-pixel vert, et la composante magenta est la valeur de luminance la plus petite des valeurs de luminance du sous-pixel rouge et du sous-pixel bleu après avoir soustrait la composante blanche des luminances d'origine du sous-pixel rouge et du sous-pixel bleu, et la composante cyan est la valeur de luminance la plus petite des valeurs de luminance du sous-pixel vert et du sous-pixel bleu après avoir soustrait la composante blanche des luminances d'origine du sous-pixel vert et du sous-pixel bleu ;

et en ce que

l'unité de synthèse de signal (123) est conçue pour

- recevoir les composantes de couleur extraites et les luminances d'origine du sous-pixel rouge, du sous-pixel vert et du sous-pixel bleu en provenance de l'unité d'extraction de composante de couleur (122),
- déterminer si vraiment la luminance d'origine du sous-pixel bleu est supérieure à zéro, et si vraiment la couleur de pixel contient la composante magenta ou la composante cyan, et,
- si la luminance d'origine du sous-pixel bleu est plus grande que zéro et si la couleur de pixel contient la composante magenta ou la composante cyan, en se basant sur la luminance d'origine du sous-pixel bleu, créer le signal d'image corrigé d'une façon qui rend la luminance à présenter en réalité par le sous-pixel bleu inférieure à la luminance d'origine, et

si la luminance d'origine du sous-pixel bleu n'est pas supérieure à zéro et/ou si la couleur de pixel ne contient pas la composante magenta et la composante cyan, créer un signal d'image corrigé d'une façon qui rend la luminance à présenter en réalité par le sous-pixel bleu égale à la luminance d'origine.

2. Dispositif d'affichage à cristaux liquides (100) selon la revendication 1, **caractérisé en ce que** l'unité de synthèse de signal (123) est conçue pour créer le signal d'Image corrigé de sorte que la luminance à présenter en réalité par le sous-pixel bleu est 0,6 fois ou 0,7 fois la luminance d'origine, si la luminance d'origine du sous-pixel bleu est supérieure à zéro et si la couleur de pixel contient la composante magenta ou la composante cyan.
3. Dispositif d'affichage à cristaux liquides (100) selon l'une quelconque des revendications 1 ou 2, **caractérisé en ce que** l'unité de synthèse de signal (123) est conçue pour créer le signal d'Image corrigé de sorte qu'une luminance maximale du sous-pixel bleu qui est fixée lorsque le pixel affiche une couleur arbitraire contenant la composante magenta ou la composante cyan est inférieure à la luminance du sous-pixel bleu qui est fixée quand le pixel affiche au moins l'un de blanc et de bleu correspondant à la valeur la plus élevée de la composante bleue.
4. Dispositif d'affichage à cristaux liquides (100) selon l'une quelconque des revendications 1 à 3, **caractérisé en ce que** les au moins trois sous-pixels Incluent un sous-pixel rouge et un sous-pixel vert.
5. Dispositif d'affichage à cristaux liquides (100) selon la revendication 4, **caractérisé en ce que** les au moins trois sous-pixels incluent en outre un sous-pixel jaune.
6. Dispositif d'affichage à cristaux liquides selon la revendication 5, **caractérisé en ce que** la section de correction de tonalité chromatique (120) fixe une luminance du sous-pixel jaune à une valeur prédéterminée.

EP 2 071 554 B1

7. Dispositif d'affichage à cristaux liquides (100) selon la revendication 4 ou 5, **caractérisé en ce que**, lorsque le pixel affiche une couleur qui contient une composante jaune, la section de correction de tonalité chromatique (120) est conçue pour créer un signal d'Image corrigé d'une façon qui rend la luminance à présenter en réalité par le sous-pixel bleu égale à la luminance d'origine.

5

8. Dispositif d'affichage à cristaux liquides (100) selon la revendication 7 ou 6, **caractérisé en ce que** les au moins trois sous-pixels incluent en outre un sous-pixel cyan.

10

15

20

25

30

35

40

45

50

55

FIG. 1

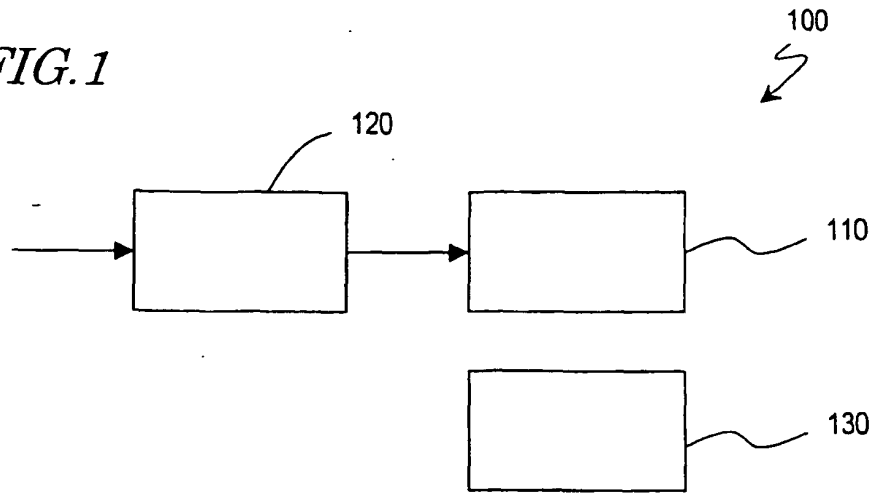

FIG. 2

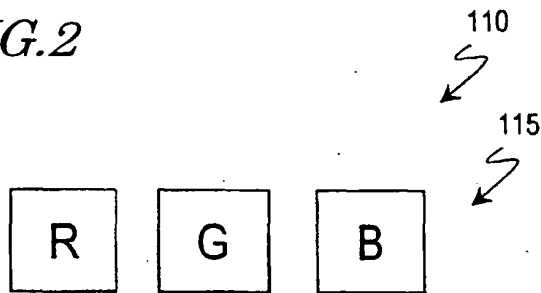

FIG. 3

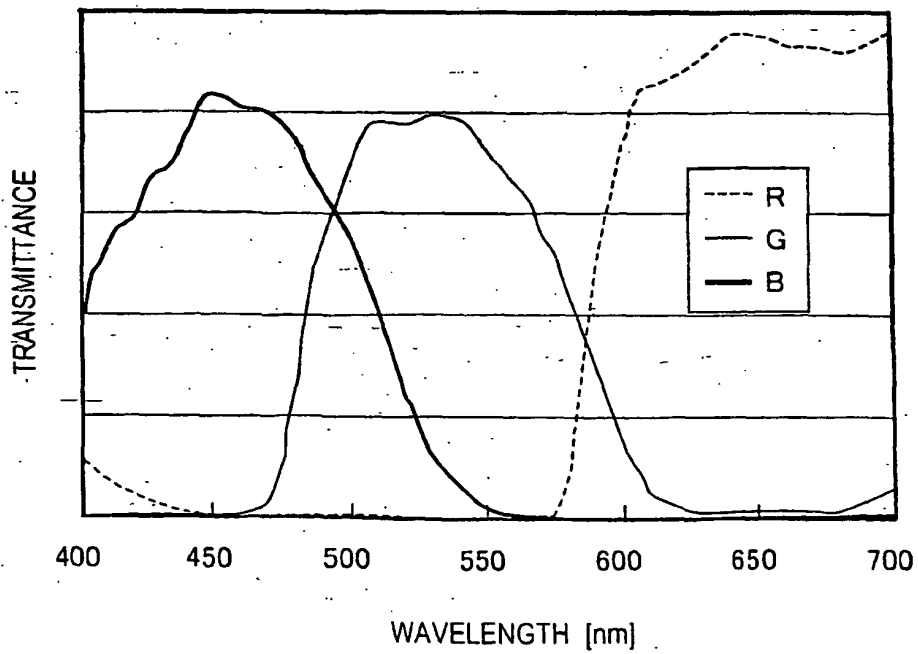

FIG.4

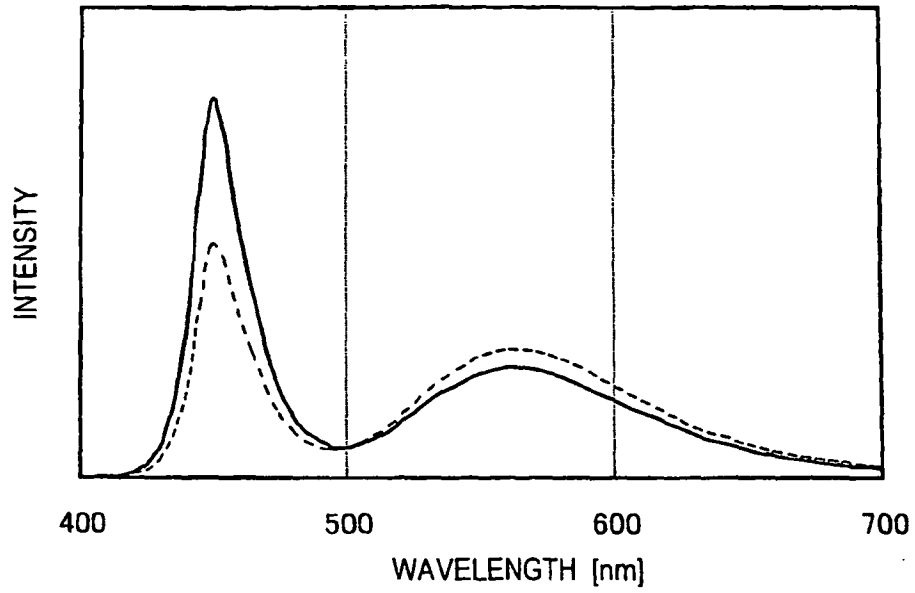

FIG.5

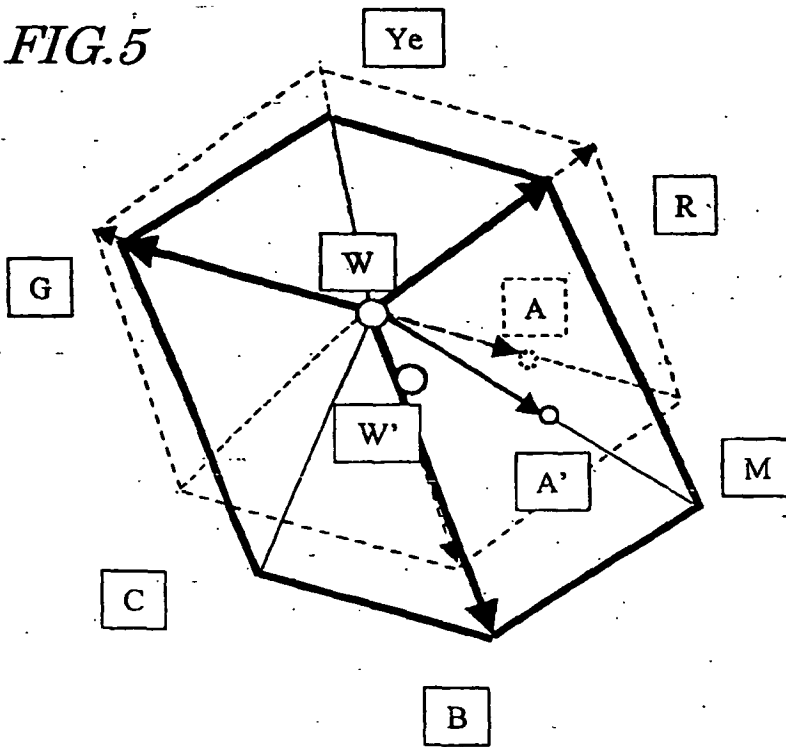

FIG.6

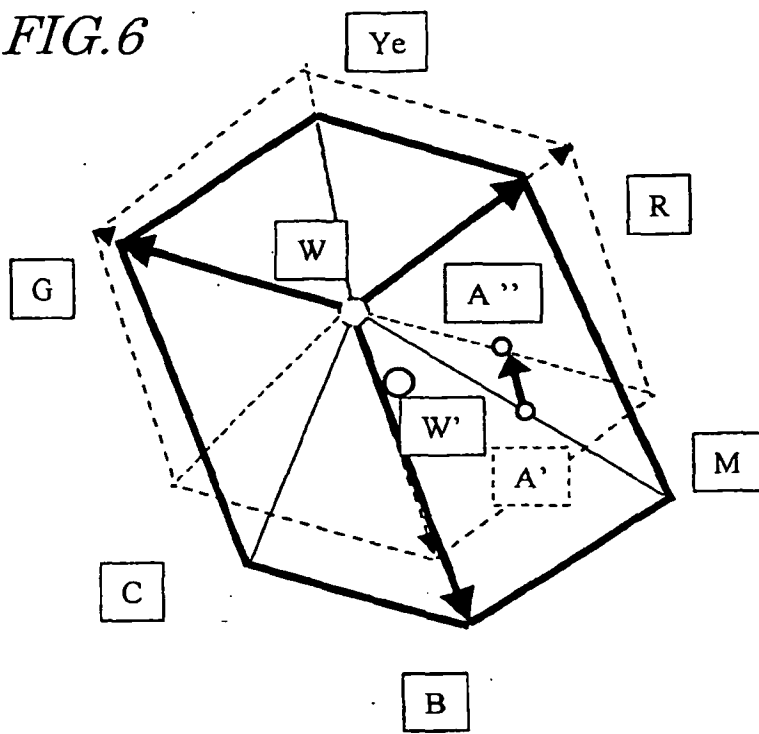

FIG. 7

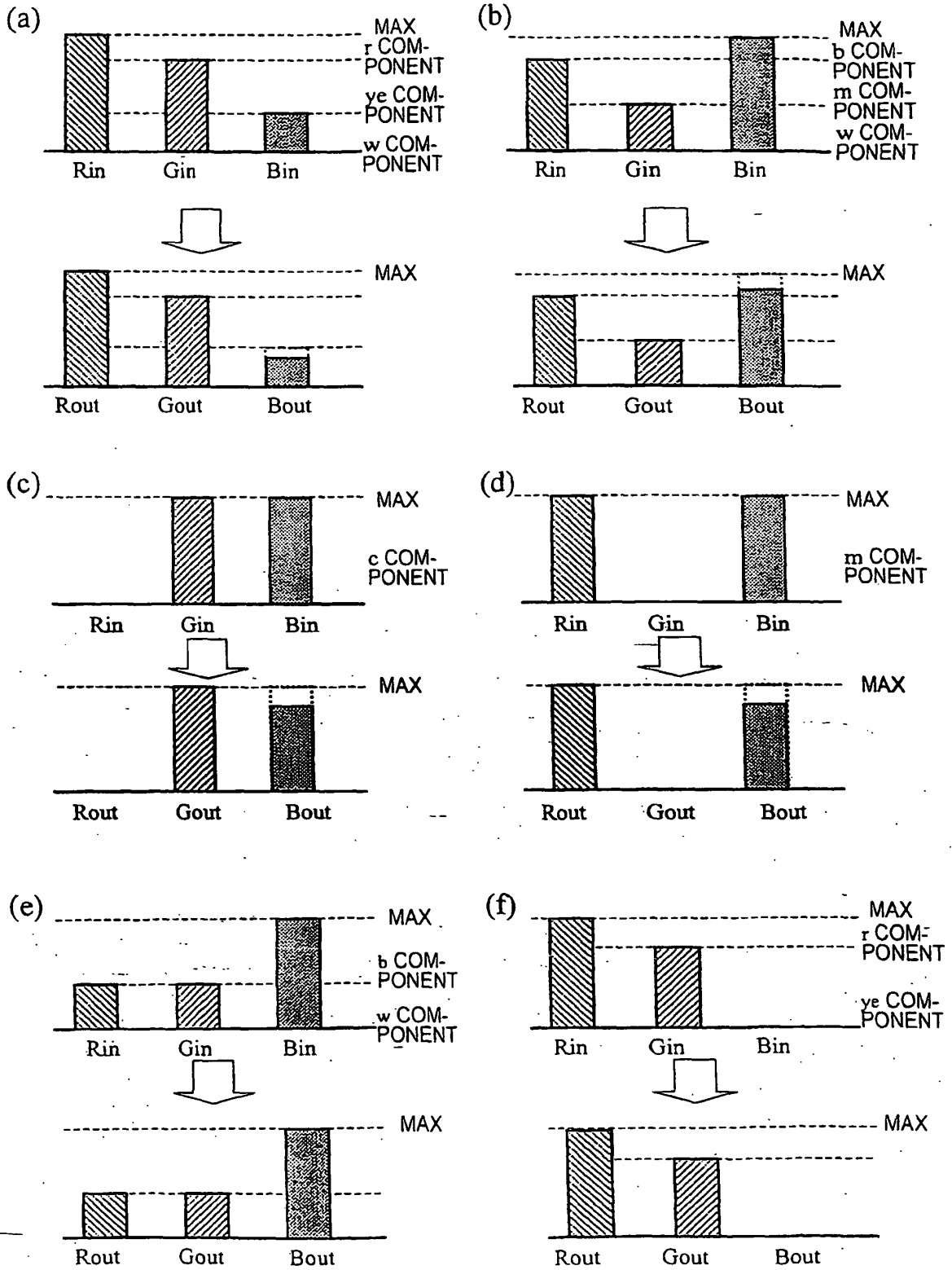
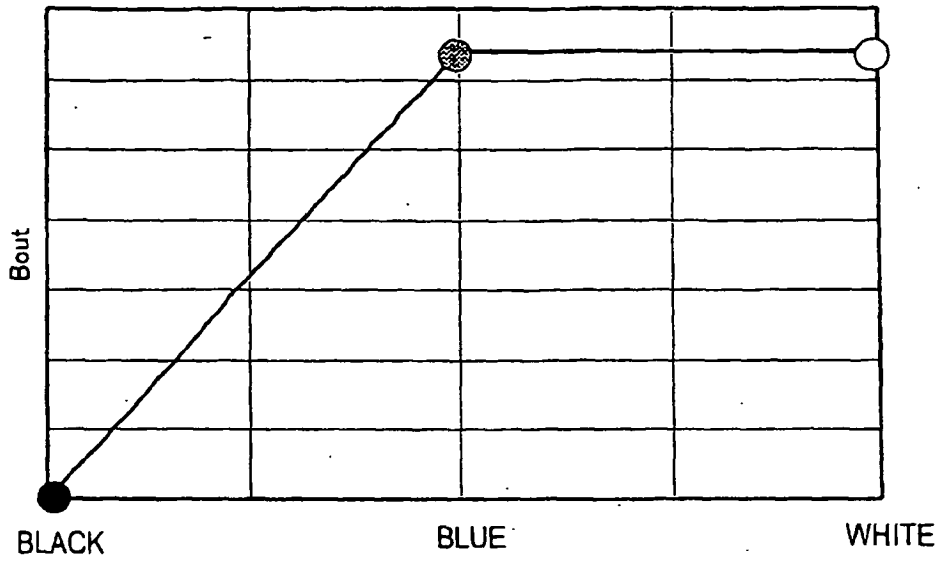

FIG. 8

(a)



(b)

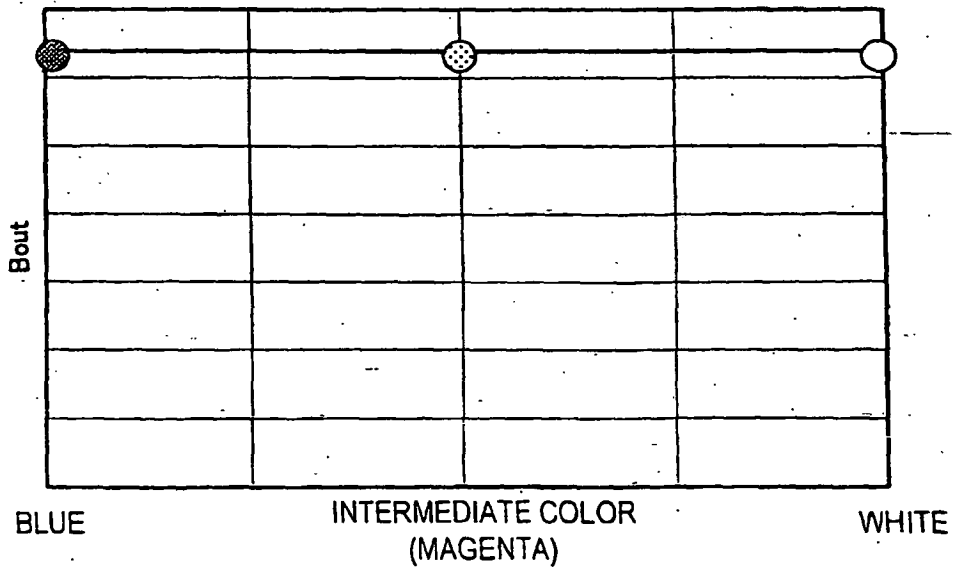

FIG. 9

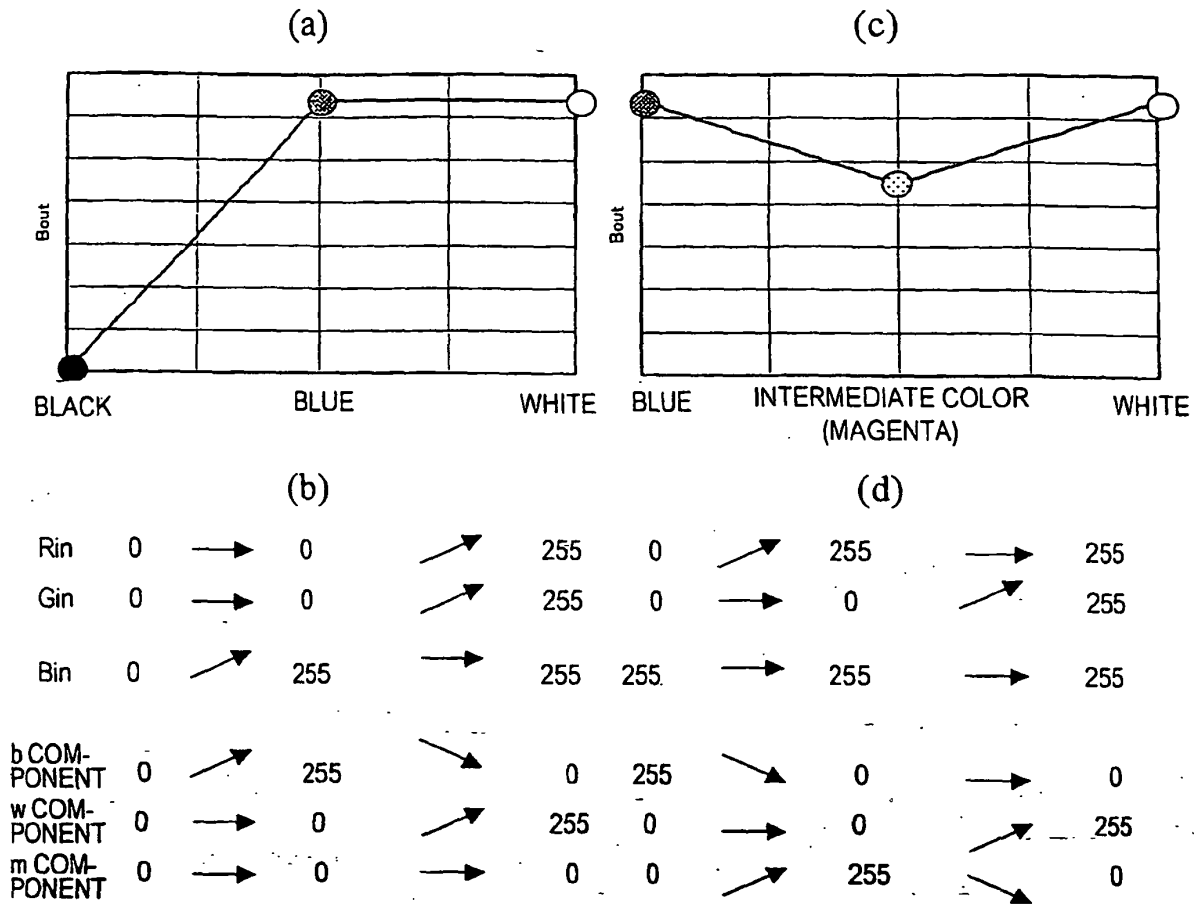

FIG. 10

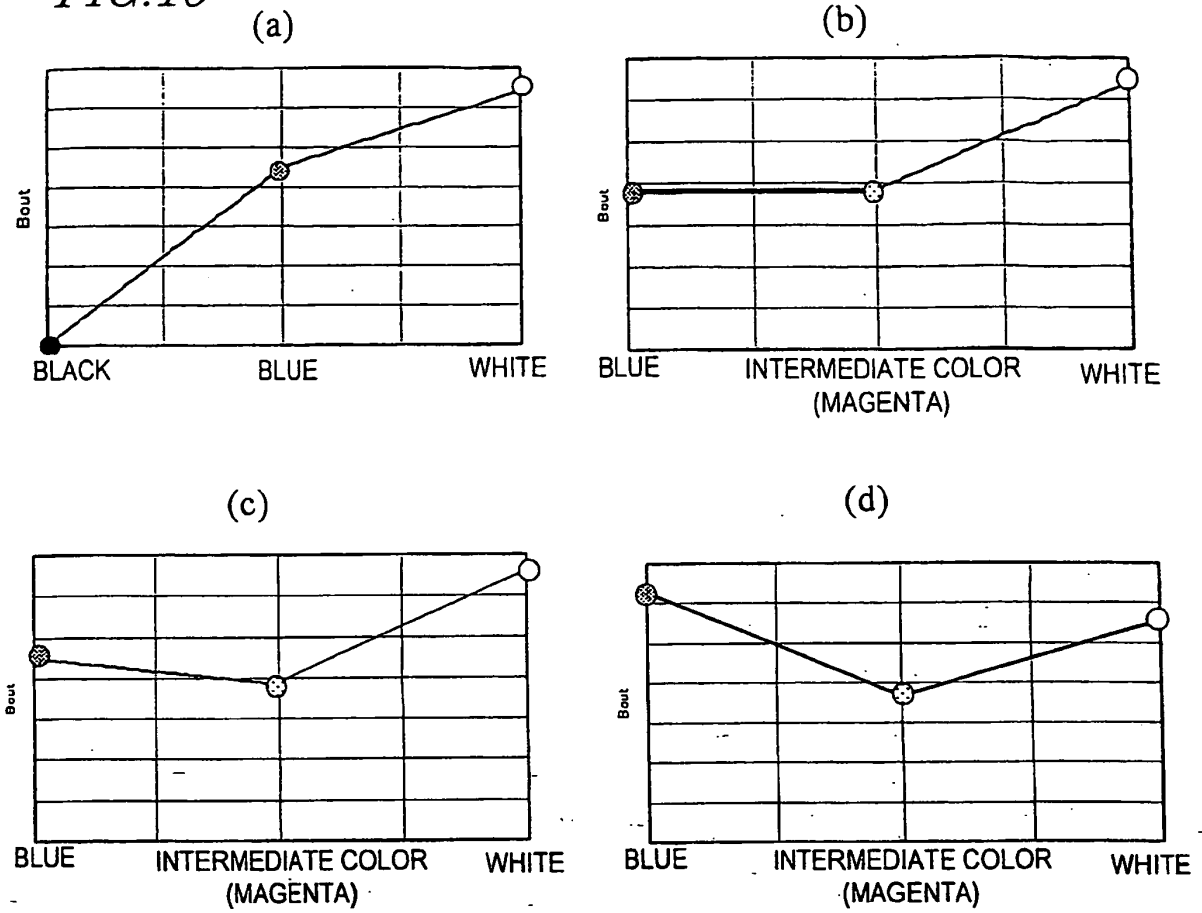

FIG. 11

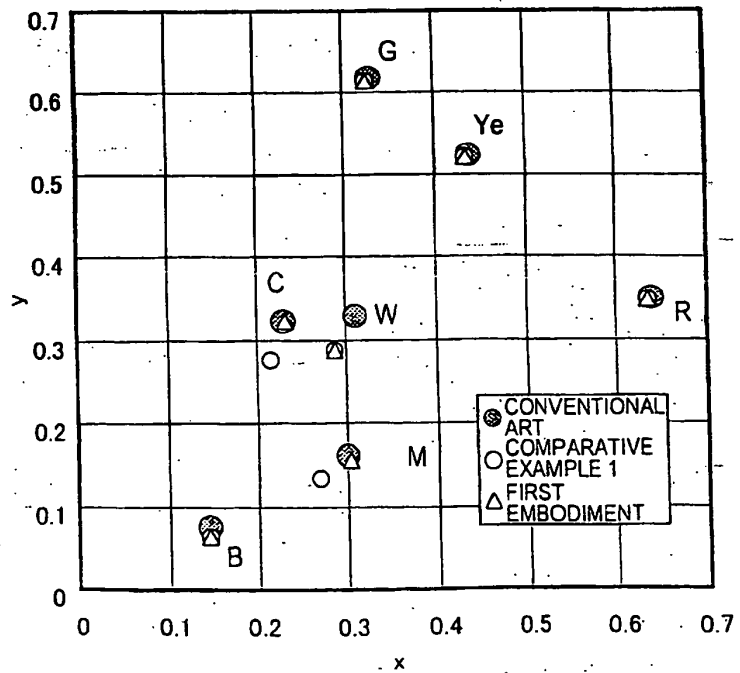

FIG. 12

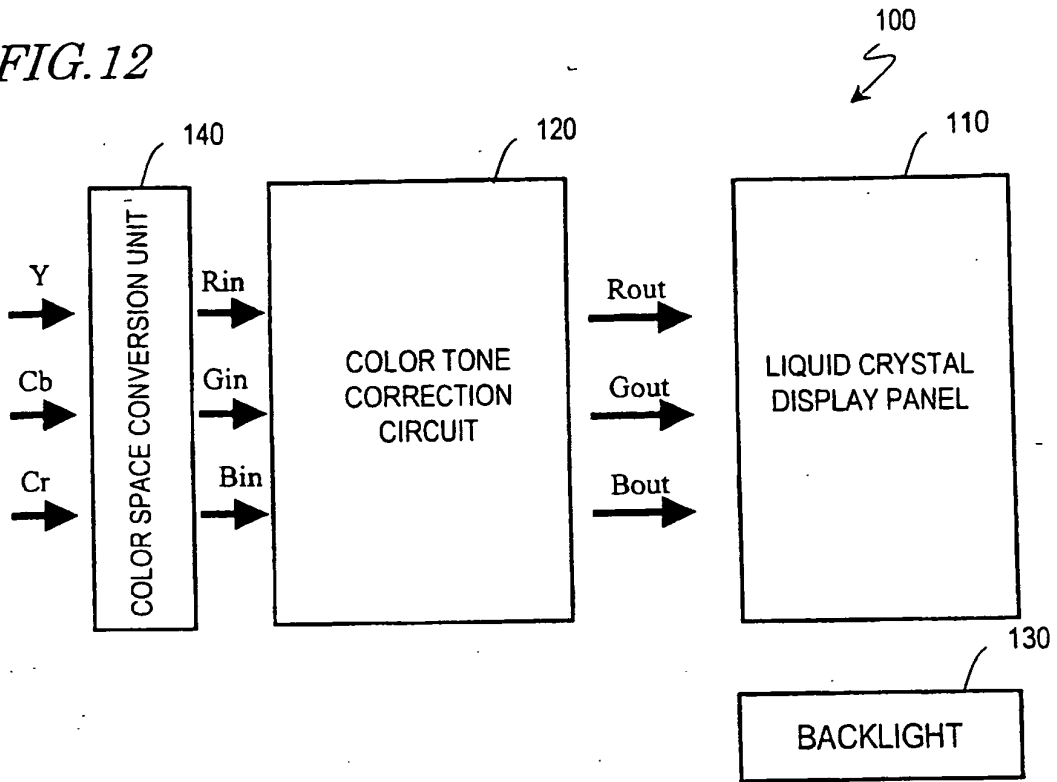

FIG. 13

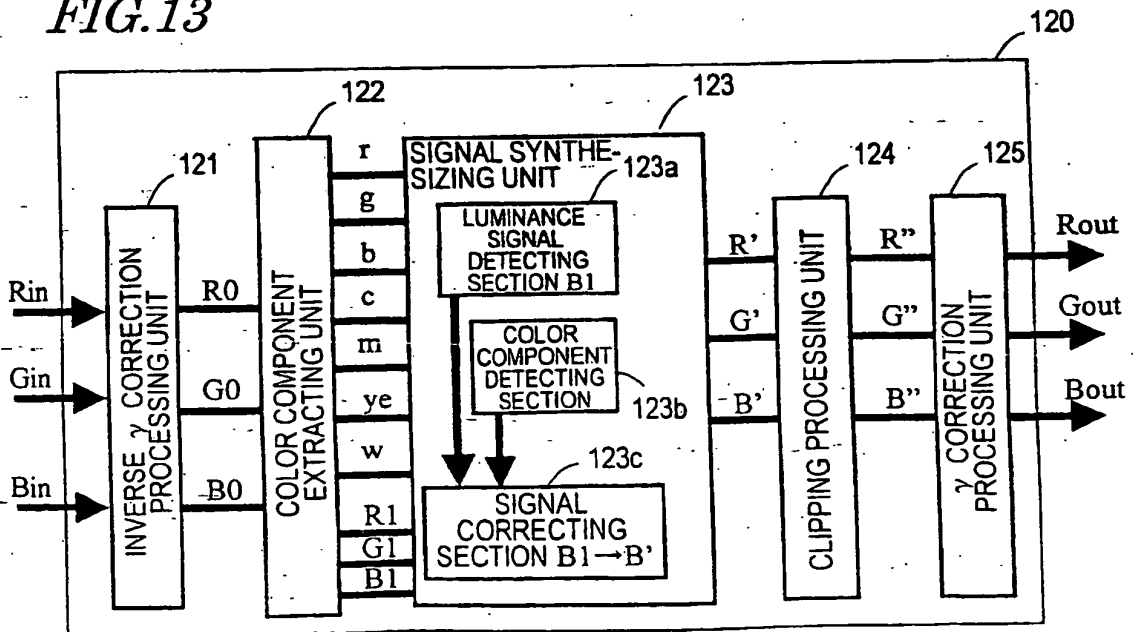

FIG. 14

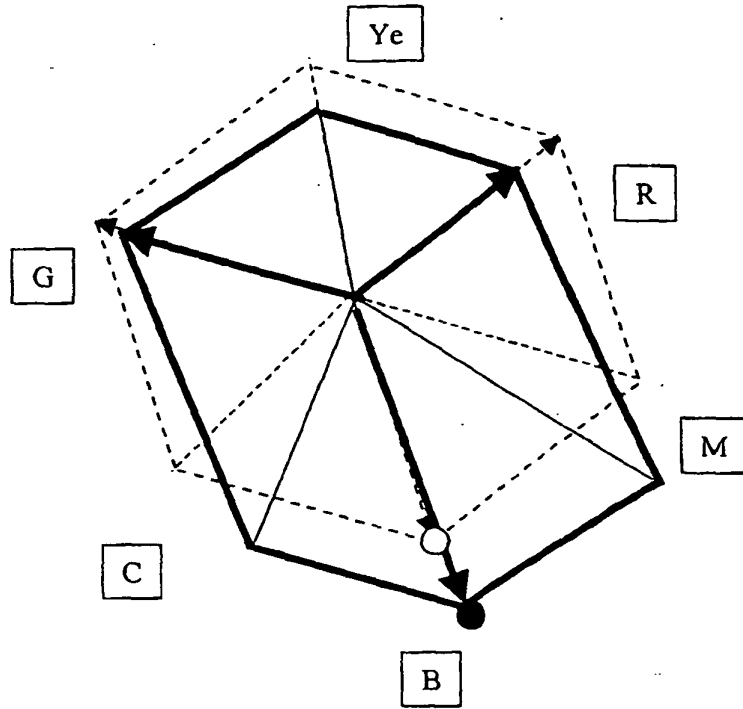

FIG. 15

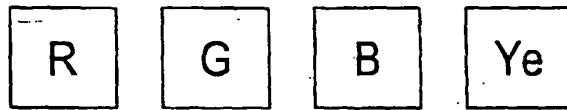

FIG. 16

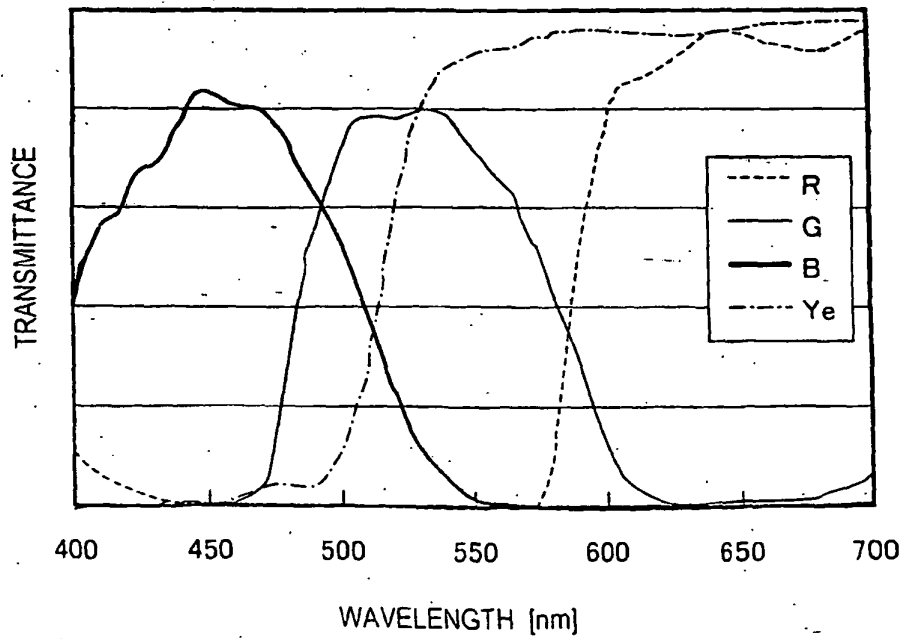

FIG. 17

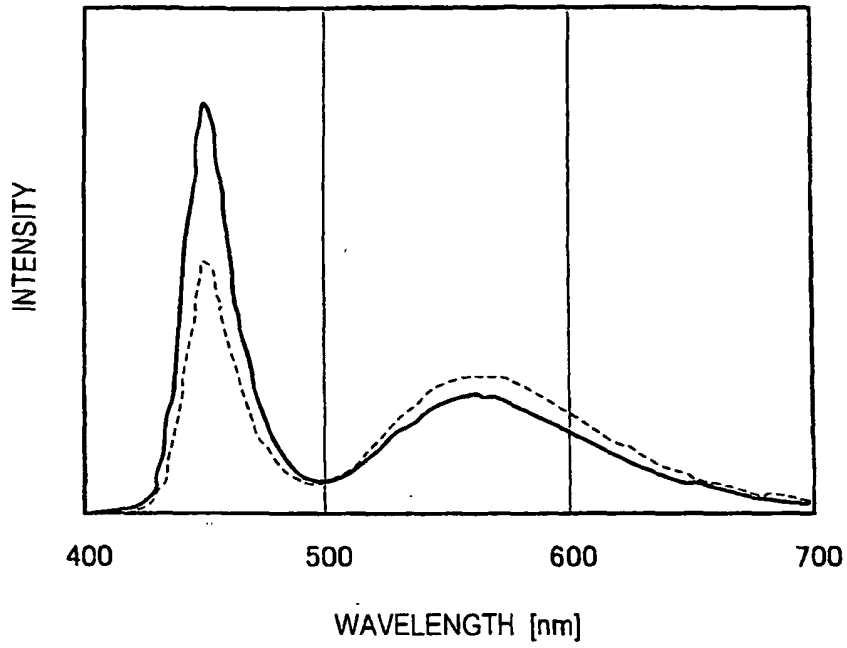

FIG. 18

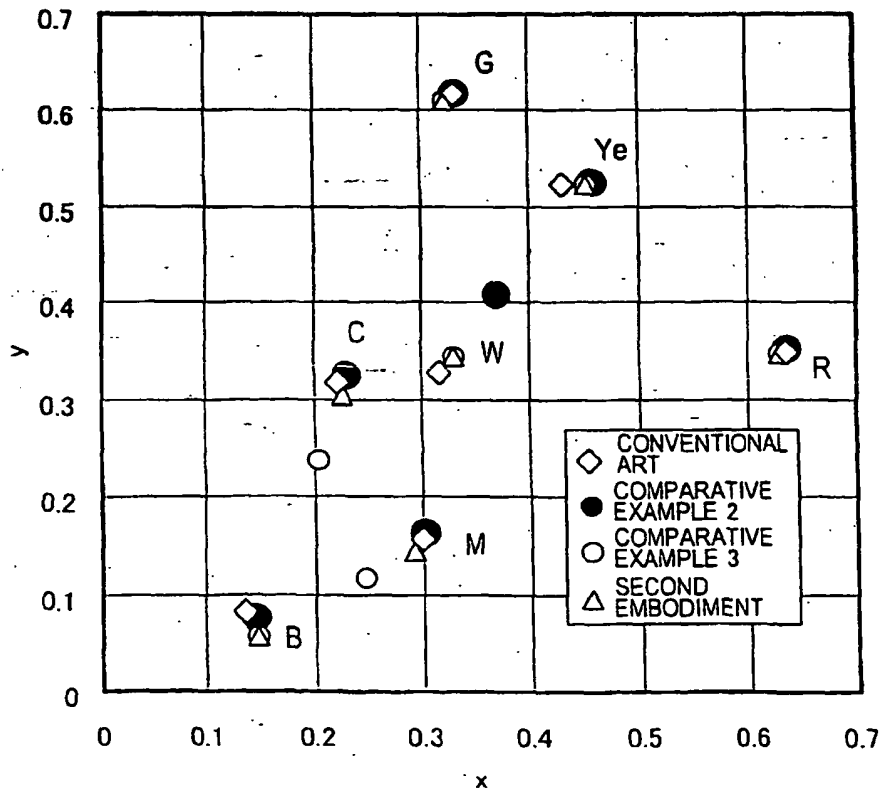

FIG. 19

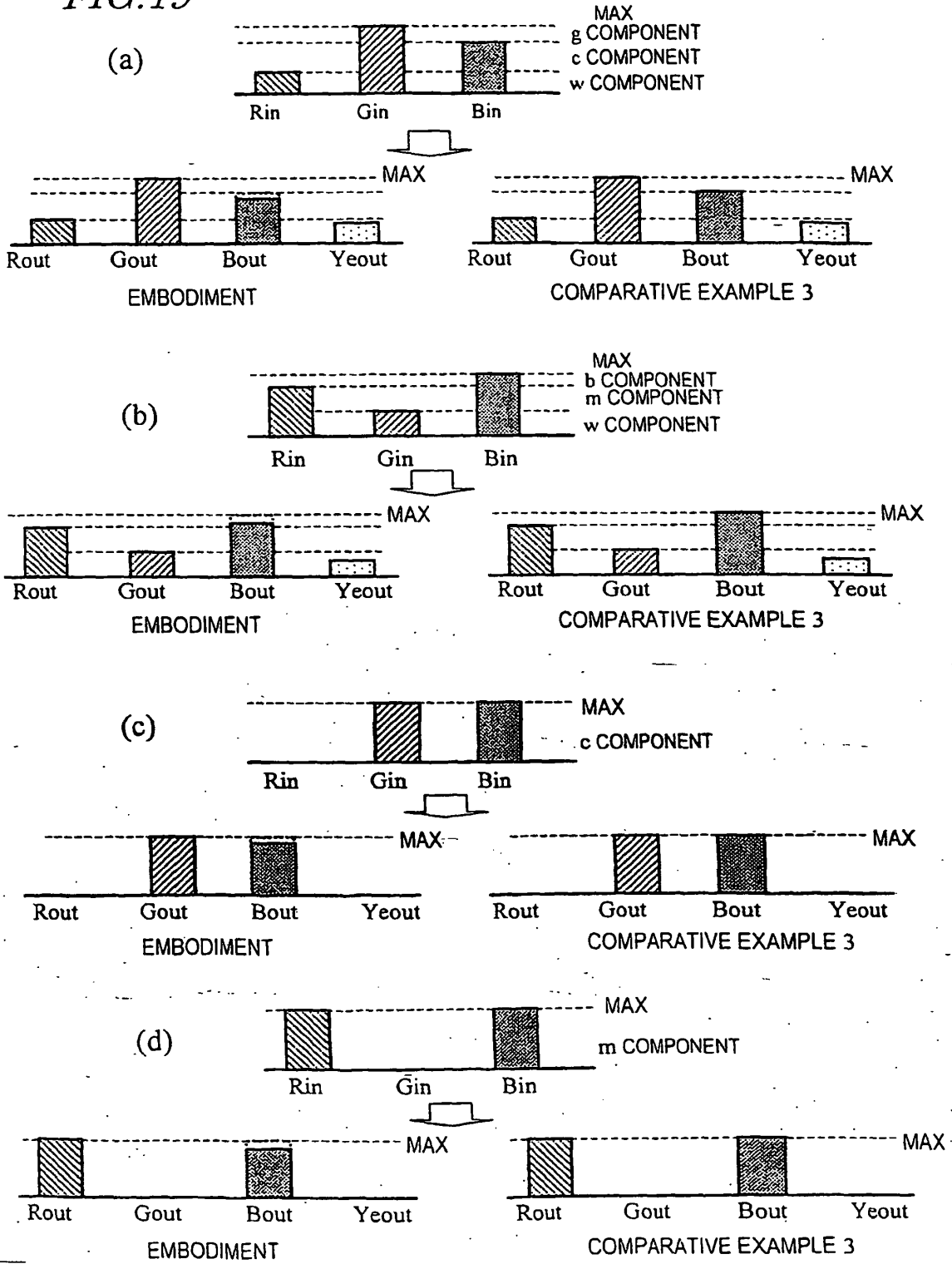

FIG. 20

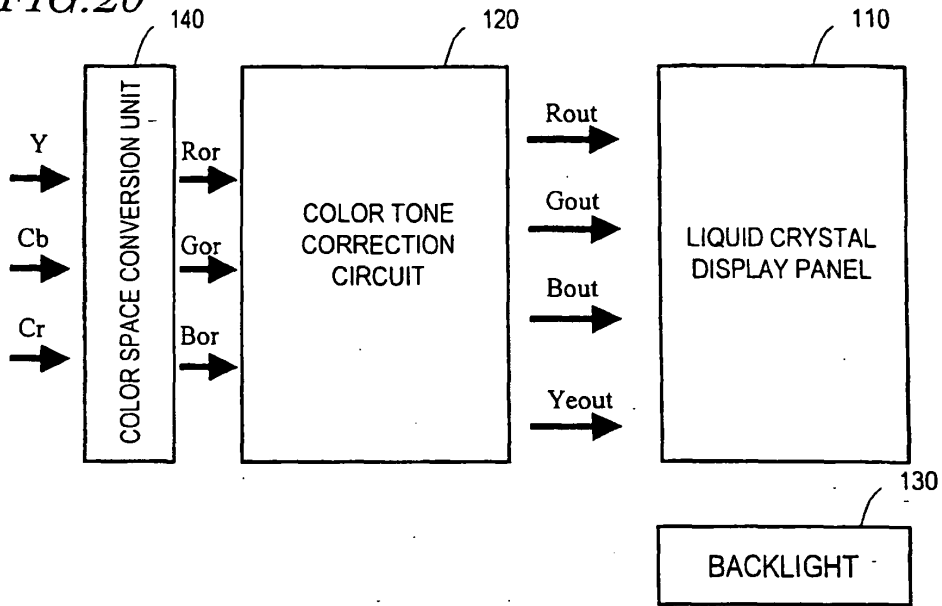

FIG. 21

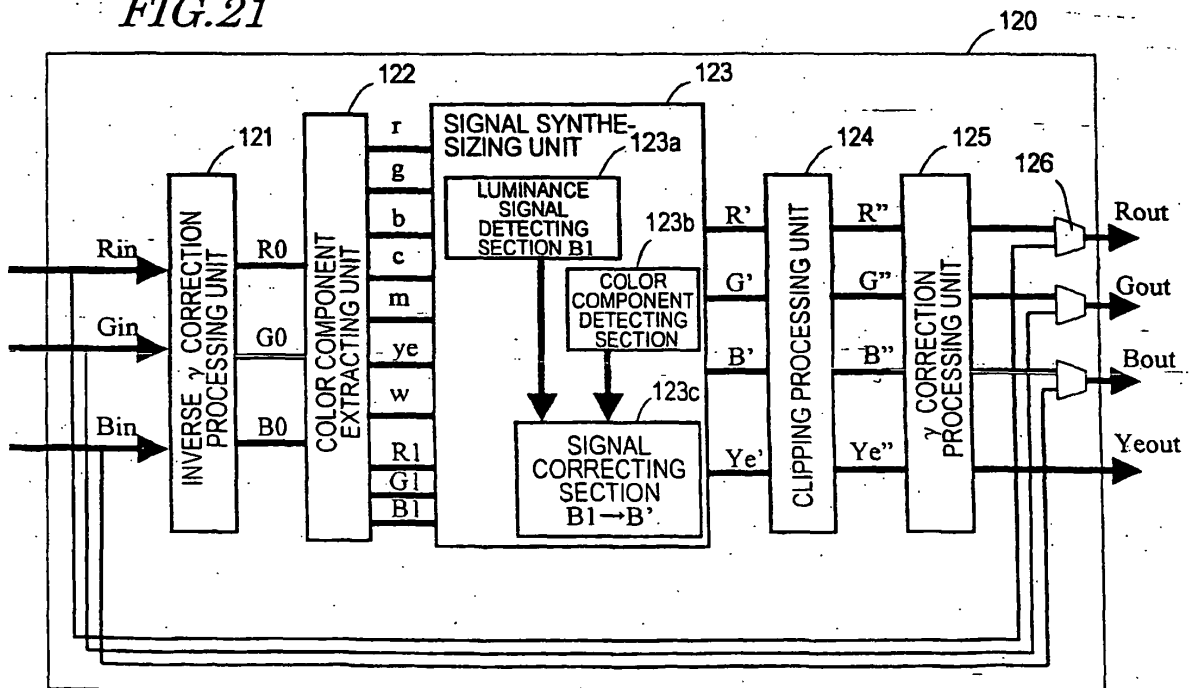

FIG.22

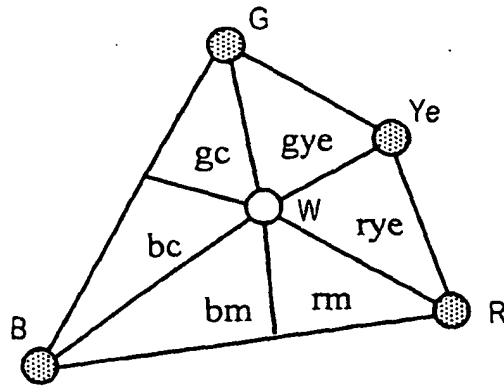

FIG.23

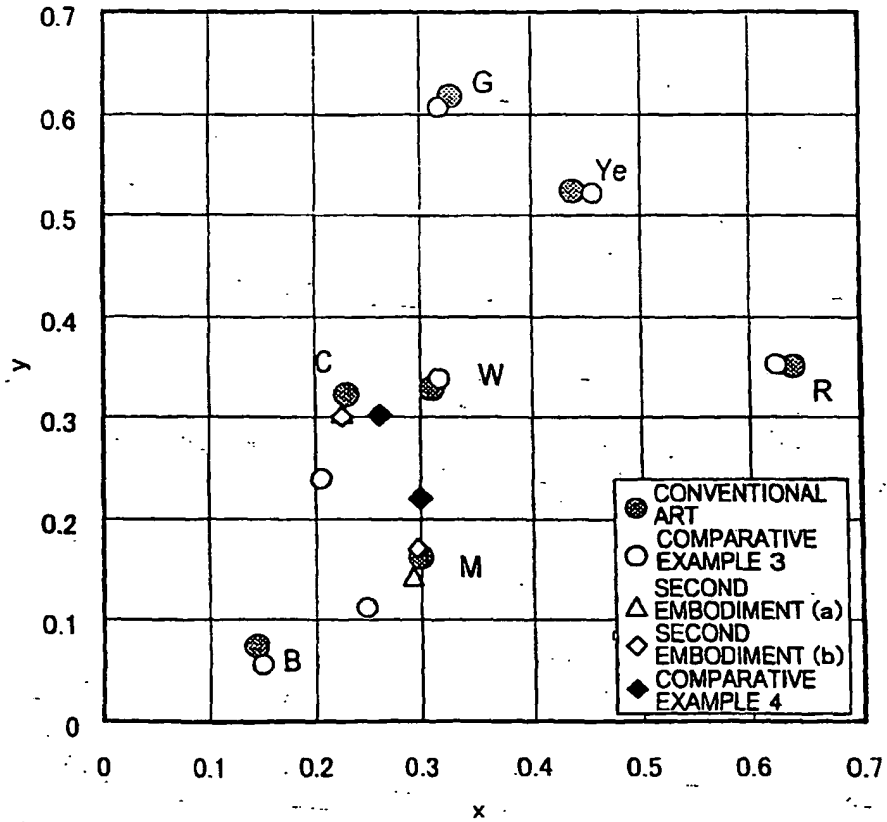

FIG.24

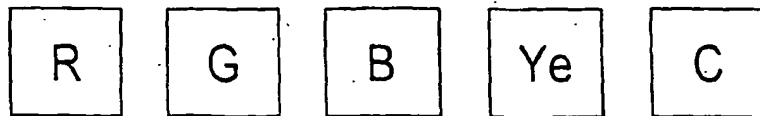

FIG. 25

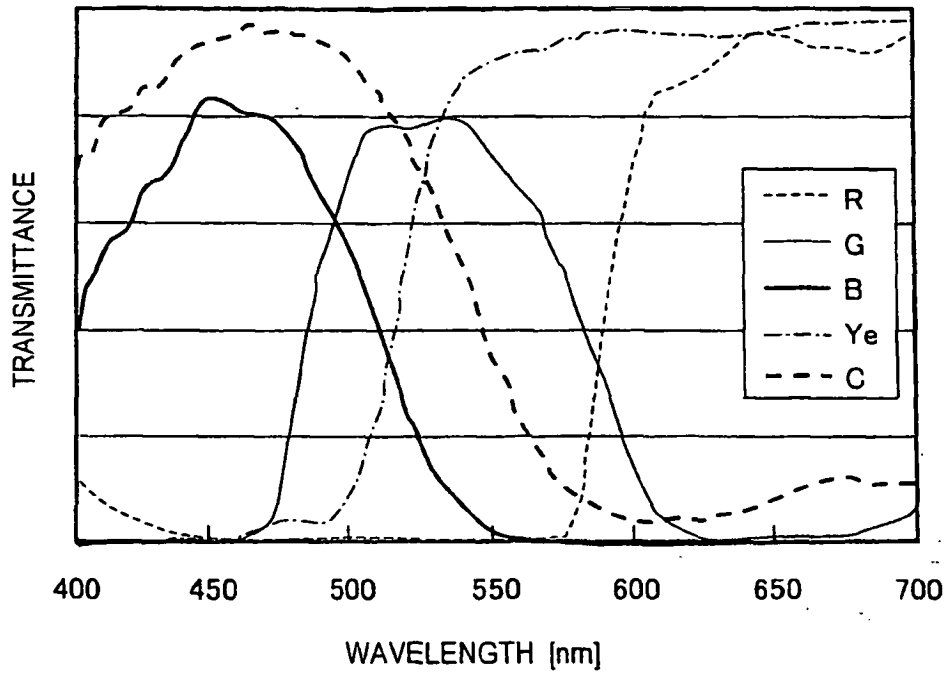

FIG. 26

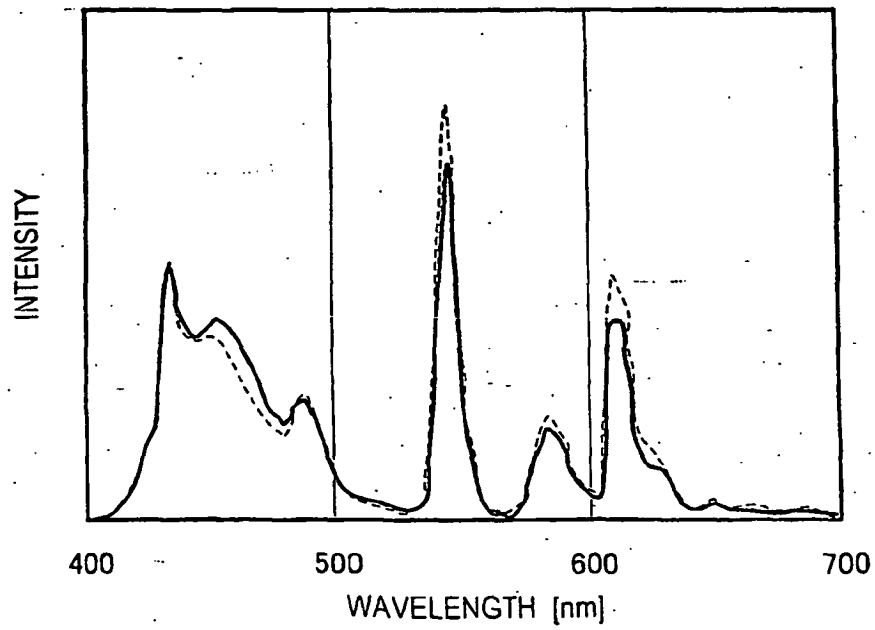

FIG.27

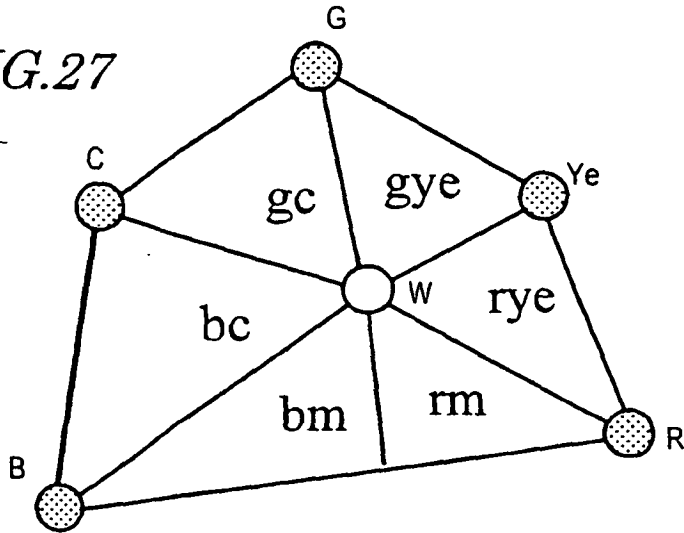

FIG.28

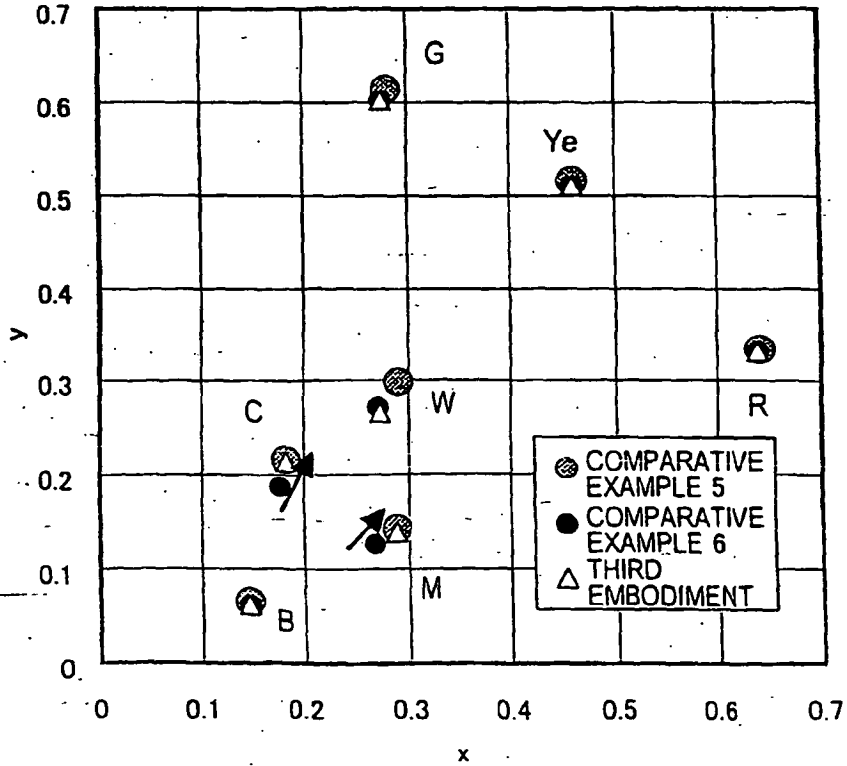

FIG.29

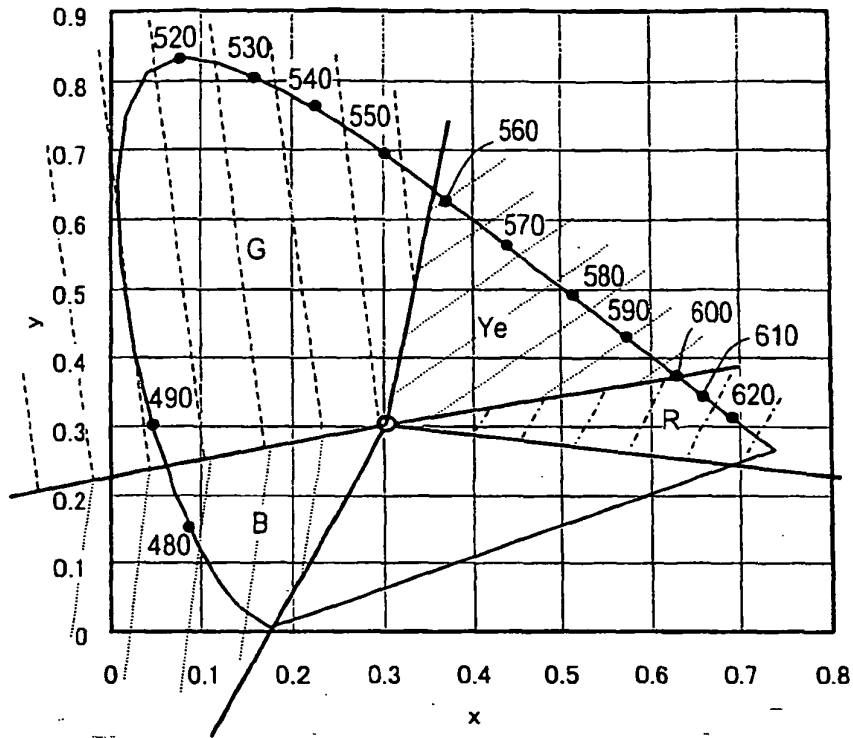

FIG.30

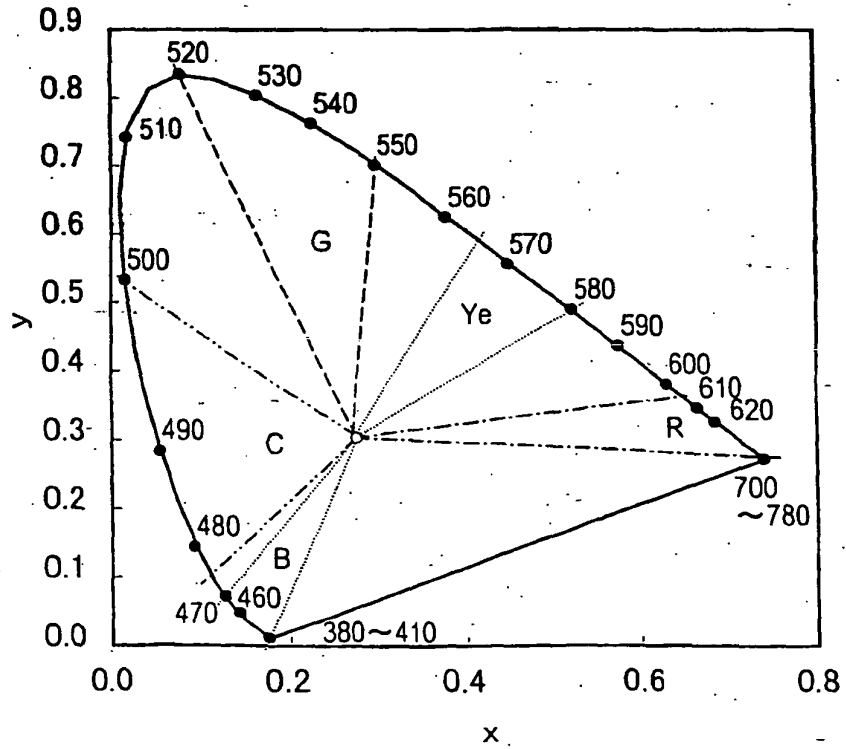

FIG. 31

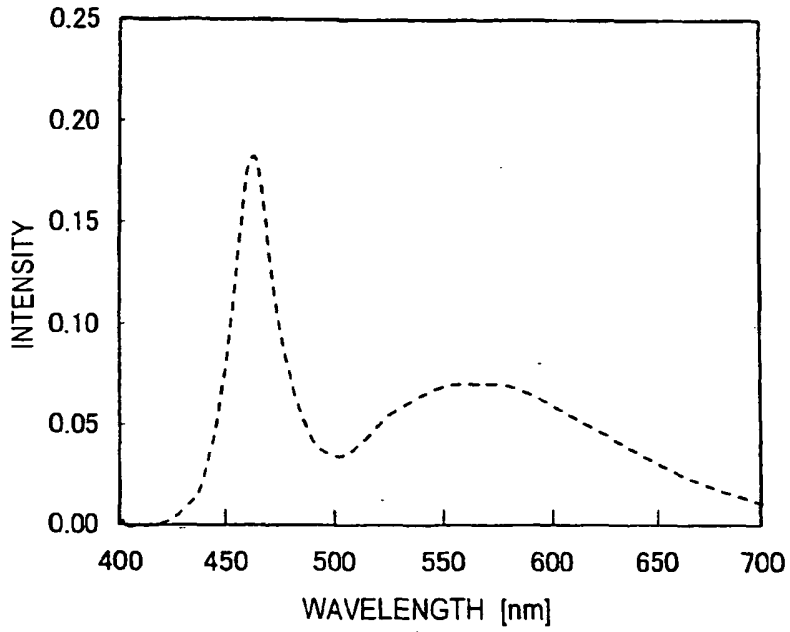

FIG. 32

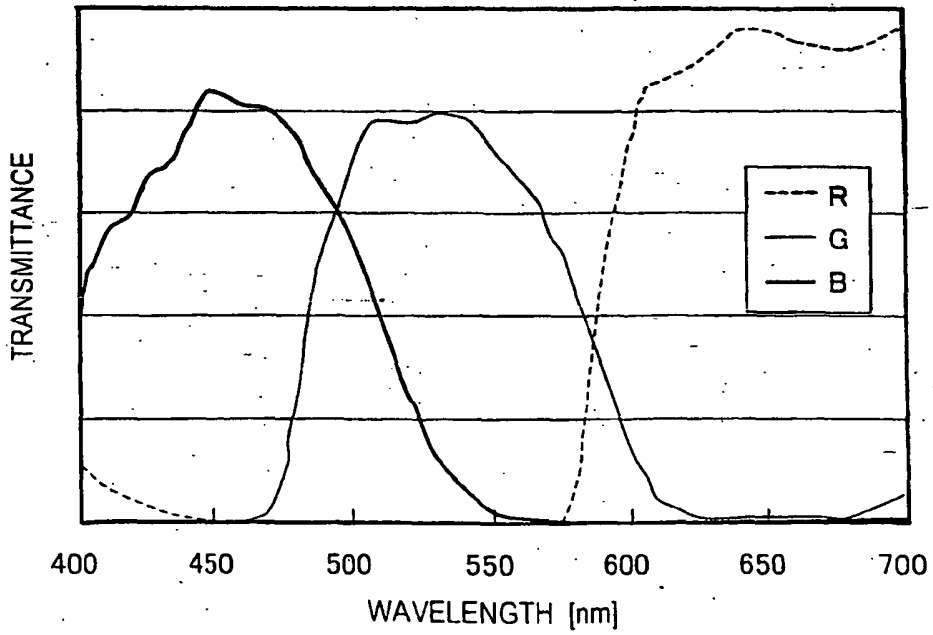

FIG. 33

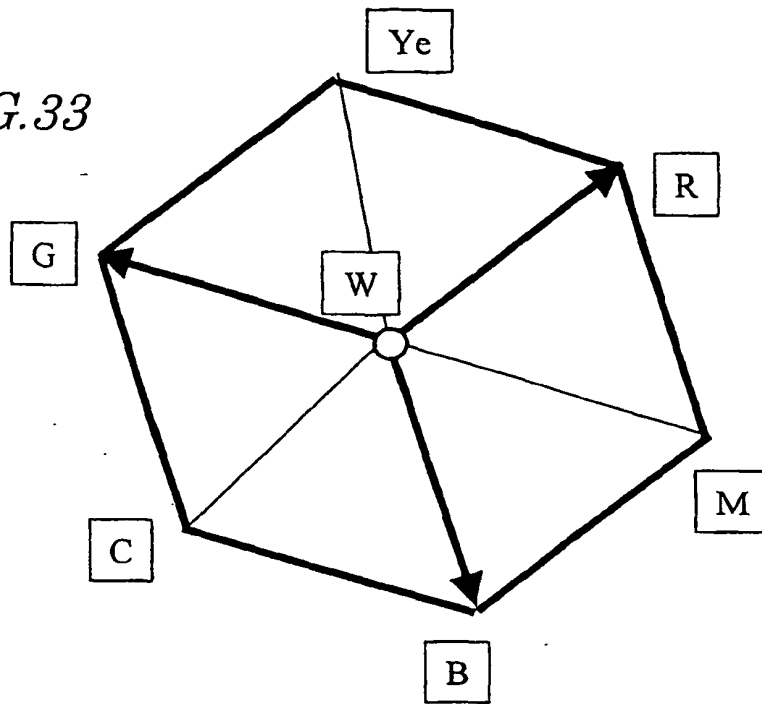
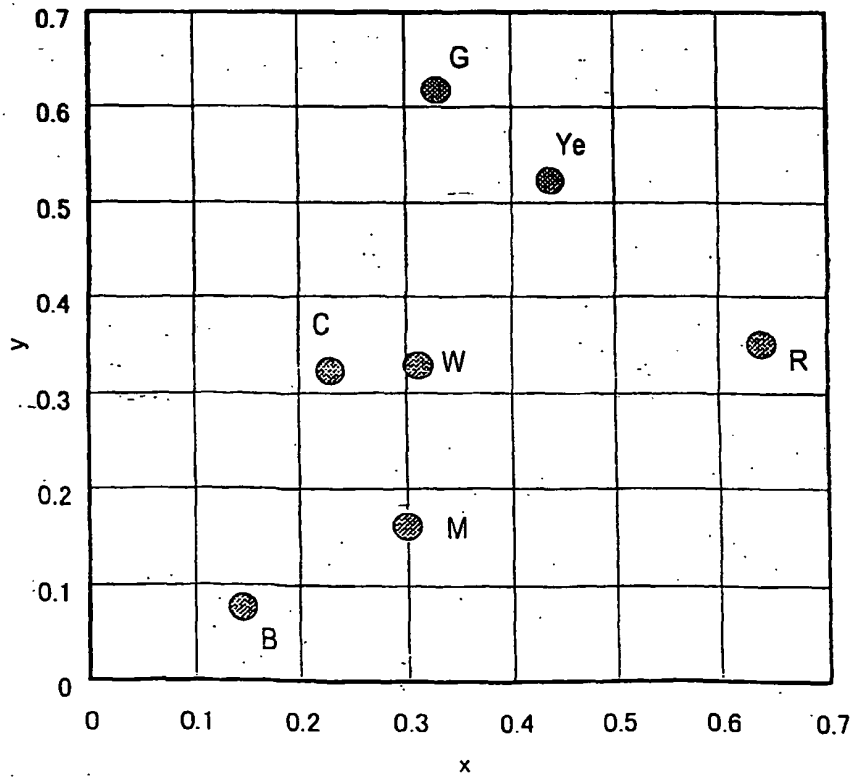

FIG. 34



REFERENCES CITED IN THE DESCRIPTION

This list of references cited by the applicant is for the reader's convenience only. It does not form part of the European patent document. Even though great care has been taken in compiling the references, errors or omissions cannot be excluded and the EPO disclaims all liability in this regard.

Patent documents cited in the description

- JP 2001228322 A [0007]
- JP 2002140038 A [0007]
- US 6300931 B [0007]
- WO 02101644 A [0007]
- JP 2005303989 A [0098]

Non-patent literature cited in the description

- Broadcasting Technology Series 2: Broadcasting Formats. Japan Broadcast Publishing Co., Ltd, 20 January 1983, 130-132 [0007]

专利名称(译)	液晶显示装置		
公开(公告)号	EP2071554A4	公开(公告)日	2009-11-11
申请号	EP2007807639	申请日	2007-09-20
[标]申请(专利权)人(译)	夏普株式会社		
申请(专利权)人(译)	夏普株式会社		
当前申请(专利权)人(译)	夏普株式会社		
[标]发明人	UEKI SHUN NAKAMURA KOZO MIYAZAKI AKIKO TAGUCHI TOKIO		
发明人	UEKI, SHUN NAKAMURA, KOZO MIYAZAKI, AKIKO TAGUCHI, TOKIO		
IPC分类号	G09G3/36 G02F1/133 G09G3/20 G09G3/34		
CPC分类号	G09G3/2003 G09G3/2074 G09G3/3607 G09G5/026 G09G2300/0452 G09G2320/0242 G09G2320/0666 G09G2340/06 G09G2340/10 G09G2360/16		
优先权	2006261410 2006-09-26 JP		
其他公开文献	EP2071554A1 EP2071554B1		
外部链接	Espacenet		

摘要(译)

一种液晶显示装置(100)，包括：液晶显示面板(110)，具有由包括蓝色子像素的至少三个子像素限定的像素；背光(130)，当像素显示白色时，向液晶显示面板(110)发射使色温达到预定水平的光；色差校正电路(120)校正由像素显示的颜色色调。当像素显示包含除白色分量和蓝色分量之外的至少一个预定颜色分量的颜色时，色调校正电路(120)进行校正以将蓝色子像素的亮度设置为低于原始蓝色子像素的亮度。亮度。

[Table 1]

NTSC ratio	Color temperature
69%	6,600 K