



(11)

EP 2 916 167 A1

(12)

EUROPEAN PATENT APPLICATION
published in accordance with Art. 153(4) EPC

(43) Date of publication:

09.09.2015 Bulletin 2015/37

(21) Application number: **13748256.8**

(22) Date of filing: **21.01.2013**

(51) Int Cl.:

G02F 1/1335 (2006.01) **C09K 19/12** (2006.01)
C09K 19/20 (2006.01) **C09K 19/30** (2006.01)
C09K 19/34 (2006.01) **C09K 19/38** (2006.01)
C09K 19/54 (2006.01) **G02B 5/20** (2006.01)
G02F 1/13 (2006.01)

(86) International application number:

PCT/JP2013/051079

(87) International publication number:

WO 2014/112122 (24.07.2014 Gazette 2014/30)

(84) Designated Contracting States:

**AL AT BE BG CH CY CZ DE DK EE ES FI FR GB
GR HR HU IE IS IT LI LT LU LV MC MK MT NL NO
PL PT RO RS SE SI SK SM TR**

Designated Extension States:

BA ME

(71) Applicant: **DIC Corporation**

Tokyo 174-8520 (JP)

(72) Inventors:

- **KURIYAMA Takeshi**
Kitaadachi-gun
Saitama 362-8577 (JP)

• **KAWAMURA Jouji**

Kitaadachi-gun
Saitama 362-8577 (JP)

• **FUNAKURA Seiji**

Kamisu-shi
Ibaraki 314-0193 (JP)

• **SHIMADA Katsunori**

Sakura-shi
Chiba 285-8668 (JP)

(74) Representative: **Beckmann, Claus et al**

Kraus & Weisert
Patentanwälte PartGmbH
Thomas-Wimmer-Ring 15
80539 München (DE)

(54) **LIQUID CRYSTAL DISPLAY DEVICE**

(57) The present invention relates to a liquid crystal display device using a specified liquid crystal composition and a color filter including a specified dye and/or pigment.

The present invention provides a liquid crystal display device capable of preventing a decrease in voltage holding ratio (VHR) of a liquid crystal layer and an increase in ion density (ID) and resolving the problem of display defects such as white spots, alignment unevenness, image sticking, and the like.

The liquid crystal display device of the present invention is characterized by preventing a decrease in voltage holding ratio (VHR) of a liquid crystal layer and an increase in ion density (ID) and suppressing the occurrence of display defects such as image sticking, and the like, and is thus particularly useful for an IPS-mode or FES-mode liquid crystal display device for active matrix driving, and can be applied to liquid crystal display devices such as a liquid crystal TV, a monitor, a cellular phone, a smart phone, and the like.

FIG. 2

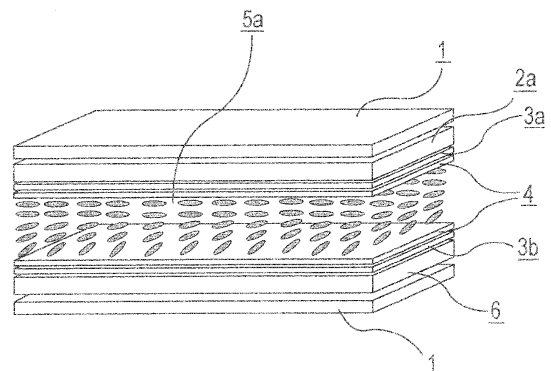

EP 2 916 167 A1

Description

Technical Field

5 **[0001]** The present invention relates to a liquid crystal display device.

Background Art

10 **[0002]** Liquid crystal display devices have been used for watches and electronic calculators, various household electric appliances, measuring apparatuses, automotive panels, word processors, electronic notebooks, printers, computers, televisions, etc. Typical examples of a liquid crystal display mode include a TN (twisted nematic) mode, a STN (super twisted nematic) mode, a DS (dynamic light scattering) mode, a GH (guest-host) mode, an IPS (in-plane switching) mode, an OCB (optically compensated birefringence) mode, an ECB (electrically controlled birefringence) mode, a VA (vertical alignment) mode, a CSH (color super-homeotropic) mode, a FLC (ferroelectric liquid crystal), and the like. Also, multiplex driving is popularized as a driving method instead of usual static driving, and a simple matrix mode and a recent active matrix (AM) method of driving by TFT (thin-film transistor), TFD (thin-film diode), or the like become the mainstream.

15 **[0003]** As shown in Fig. 1, a general color liquid crystal display device includes two substrates (1) each having an alignment film (4), a transparent electrode layer (3a) serving as a common electrode and a color filter layer (2) which are disposed between one of the alignment films and the substrate, and a pixel electrode layer (3b) disposed between the other alignment film and the substrate, the substrates are arranged so that the alignment films thereof face each other, and a liquid crystal layer (5) is held between the substrates.

20 **[0004]** The color filter layer is composed of a black matrix and a color filter including a red color layer (R), a green color layer (G), a blue color layer (B), and, if required, a yellow color layer (Y).

25 **[0005]** Liquid crystal materials constituting liquid crystal layers have undergone a high level of impurity control because impurities remaining in the materials significantly affect electric characteristics of display devices. In addition, with respect to materials constituting alignment films, it has already been known that an alignment film is in direct contact with a liquid crystal layer, and impurities remaining in the alignment film are moved to the liquid crystal layer and affect the electric characteristics of the liquid crystal layer, and thus characteristics of a liquid crystal display device due to impurities in an alignment film material have been being investigated.

30 **[0006]** On the other hand, with respect to materials such as organic pigments and the like used in the color filter layers, like the alignment film materials, it is supposed that impurities contained affect the liquid crystal layers. However, an alignment film and a transparent electrode are interposed between the color filter layer and the liquid crystal layer, and thus it has been considered that the direct influence on the liquid crystal layer is greatly smaller than that of the alignment film material. However, the alignment film generally has a thickness of as small as 0.1 μm or less, and the transparent electrode, for example, even a common electrode used on the color filter layer side and having a thickness increased for enhancing conductivity, generally has a thickness of 0.5 μm or less. Therefore, the color filter layer and the liquid crystal layer are not put in a completely isolated environment, and the color filter layer has the possibility of developing display defects such as white spots, alignment unevenness, image sticking, and the like due to a decrease in voltage holding ratio (VHR) of the liquid crystal layer and an increase in ion density (ID) which are caused by impurities contained in the color filter layer through the alignment film and the transparent electrode.

35 **[0007]** As a method for resolving the display defects due to impurities contained in pigments which constitute a color filter, there have been studied a method of controlling elusion of impurities into a liquid crystal by using a pigment in which a ratio of an extract with ethyl formate is decreased to a specified value or less (Patent Literature 1), and a method of controlling elusion of impurities into a liquid crystal by specifying a pigment in a blue color layer (Patent Literature 2). However, these methods are not much different from a method of simply decreasing impurities in a pigment, and are thus unsatisfactory for improvement for resolving the display defects even in the present situation in which a pigment purifying technique has recently been advanced.

40 **[0008]** On the other hand, with attention paid to a relation between organic impurities contained in a color filter and a liquid crystal composition, there are disclosed a method of specifying a hydrophobic parameter of liquid crystal molecules contained in a liquid crystal layer to be equal to or higher than a predetermined value, the hydrophobic parameter representing insolubility of the organic impurities in the liquid crystal layer, and a method of preparing a liquid crystal composition containing a predetermined ratio or more of a liquid crystal compound having $-\text{OCF}_3$ groups at the ends of liquid crystal molecules because the $-\text{OCF}_3$ groups at the ends of liquid crystal molecules have a correlation to the hydrophobic parameter (Patent Literature 3).

55 **[0009]** However, these cited documents each disclose an invention based on the principle that the influence of impurities in a pigment on a liquid crystal layer is suppressed and disclose no research on a direct relation between a structure of a liquid crystal material and a structure of a colorant such as a dye/pigment or the like used in a color filter, not leading

to the resolution of the problem of display defects in advanced liquid crystal display devices.

Citation List

5 Patent Literature

[0010]

10 PTL 1: Japanese Unexamined Patent Application Publication No. 2000-19321
 PTL 2: Japanese Unexamined Patent Application Publication No. 2009-109542
 PTL 3: Japanese Unexamined Patent Application Publication No. 2000-192040

Summary of Invention

15 Technical Problem

[0011] The present invention is aimed at providing a liquid crystal display device including a specified liquid crystal composition and a color filter using a specified dye and/or pigment in order to prevent a decrease in voltage holding ratio (VHR) of a liquid crystal layer and an increase in ion density (ID), thereby resolving the problems of display defects such as white spots, alignment unevenness, image sticking, and the like.

Solution to Problem

25 [0012] In order to solve the above-described problems, the inventors intensively studied combinations of colorants such as a dye/pigment and the like which constitute a color filter and structures of liquid crystal materials constituting a liquid crystal layer. As a result it was found that a liquid crystal display device using a specified-structure liquid crystal composition and a color filter containing a specified-structure dye and/or pigment prevents a decrease in voltage holding ratio (VHR) of a liquid crystal layer and an increase in ion density (ID), thereby resolving the problems of display defects such as white spots, alignment unevenness, image sticking, and the like. This led to the achievement of the present invention.

30 [0013] That is, the present invention provides a liquid crystal display device including a first substrate, a second substrate, a liquid crystal composition layer held between the first substrate and the second substrate, a color filter including a black matrix and at least RGB three-color pixel portions, a pixel electrode, and a common electrode, the liquid crystal composition layer including a liquid crystal composition which contains at least one compound represented by general formula (I),

[Chem. 1]

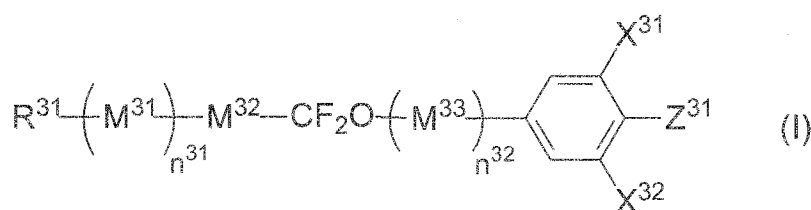

(in the formula, R³¹ represents an alkyl group having 1 to 10 carbon atoms, an alkoxy group, or an alkenyl group or alkenyloxy group having 2 to 10 carbon atoms, M³¹ to M³³ each independently represent a trans-1,4-cyclohexylene group or a 1,4-phenylene group, one or two -CH₂- in the trans-1,4-cyclohexylene group may be substituted by -O- so that oxygen atoms are not directly adjacent to each other, one or two hydrogen atoms in the phenylene group may be substituted by fluorine atoms, X³¹ and X³² each independently represent a hydrogen atom or a fluorine atom, Z³¹ represents a fluorine atom, a trifluoromethoxy group, or a trifluoromethyl group, n³¹ and n³² each independently represent 0, 1, or 2, n³¹ + n³² represents 0, 1, or 2, and when a plurality of each of M³¹ and M³³ are present, each may be the same or different), and at least one compound selected from the group consisting of compounds represented by general formula (II-a) to (II-e), [0011]

55

[Chem. 2]

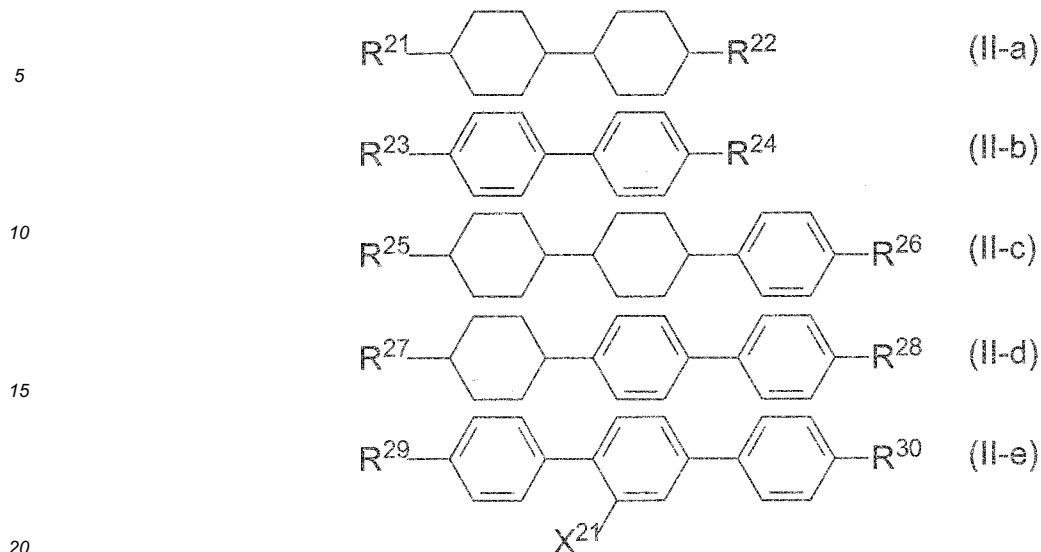

(in the formula, R²¹ to R³⁰ each independently represent an alkyl group having 1 to 10 carbon atoms or an alkenyl group having 2 to 10 carbon atoms, and X²¹ represents a hydrogen atom or a fluorine atom), and the RGB three-color pixel portions include, as colorants, a diketopyrrolopyrrole pigment and/or anionic red organic dye in a R pixel portion, at least one selected from the group consisting of a halogenated copper phthalocyanine pigment, a phthalocyanine green dye, and a mixture of a phthalocyanine blue dye and an azo yellow organic dye in a G pixel portion, and a ε-type copper phthalocyanine pigment and/or cationic blue organic dye in a B pixel portion.

Advantageous Effects of Invention

[0014] A liquid crystal display device according to the present invention is capable of preventing a decrease in voltage holding ratio (VHR) of a liquid crystal layer and an increase in ion density (ID) by using a specified liquid crystal composition and a color filter including a specified dye and/or pigment, thereby resolving the problems of display defects such as white spots, alignment unevenness, image sticking, and the like.

Brief Description of Drawings

[0015]

[Fig. 1] Fig. 1 is a drawing showing an example of a general liquid crystal display device.

[Fig. 2] Fig. 2 is a drawing showing an example of a liquid crystal display device according to the present invention.

Reference Signs List

[0016]

- 1 substrate
- 2 color filter layer
- 2a color filter layer containing specified dye and/or pigment
- 3a transparent electrode layer (common electrode)
- 3b pixel electrode layer
- 4 alignment film
- 5 liquid crystal layer
- 5a liquid crystal layer containing specified liquid crystal composition

Description of Embodiments

[0017] Fig. 2 shows an example of a liquid crystal display device according to the present invention. Two substrates

(1) including a first substrate and a second substrate each have an alignment film (4), a transparent electrode layer (3a) serving as a common electrode and a color filter layer (2a) containing a specified dye and/or pigment are disposed between one of the alignment films (4) and the substrate, a pixel electrode layer (3b) is disposed between the other alignment film and the substrate, the substrates are arranged so that the alignment films face each other, and a liquid crystal layer (5a) containing a specified liquid crystal composition is held between the substrates.

[0018] The two substrates in the display device are bonded together with a sealing material disposed in a peripheral region, and in many cases, a granular spacer or a resin spacer columns formed by a photolithography method is disposed between the substrates in order to maintain a gap between the substrates.

(Liquid crystal composition layer)

[0019] A liquid crystal composition layer in the liquid crystal display device of the present invention includes a liquid crystal composition which contains at least one compound represented by general formula (I),

[Chem. 3]

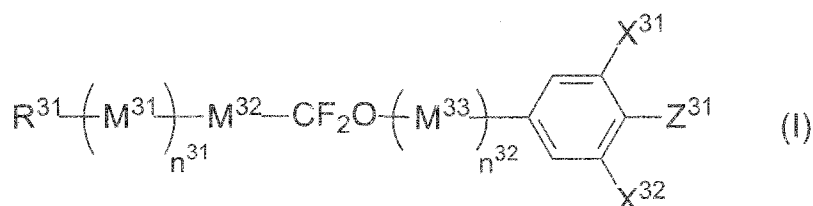

(in the formula, R^{31} represents an alkyl group having 1 to 10 carbon atoms, an alkoxy group, or an alkenyl group or alkenyloxy group having 2 to 10 carbon atoms, M^{31} to M^{33} each independently represent a trans-1,4-cyclohexylene group or a 1,4-phenylene group, one or two $-CH_2-$ in the trans-1,4-cyclohexylene group may be substituted by $-O-$ so that oxygen atoms are not directly adjacent to each other, one or two hydrogen atoms in the phenylene group may be substituted by fluorine atoms, X^{31} and X^{32} each independently represent a hydrogen atom or a fluorine atom, Z^{31} represents a fluorine atom, a trifluoromethoxy group, or a trifluoromethyl group, n^{31} and n^{32} each independently represent 0, 1, or 2, $n^{31} + n^{32}$ represents 0, 1, or 2, and when a plurality of each of M^{31} and M^{33} are present, each may be the same or different), and at least one compound selected from the group consisting of compounds represented by general formula (II-a) to (II-e),

[Chem. 4]

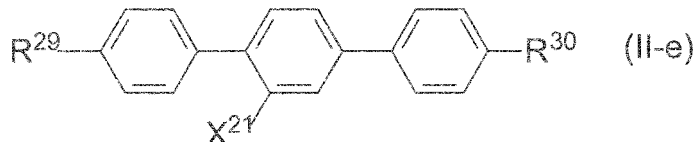
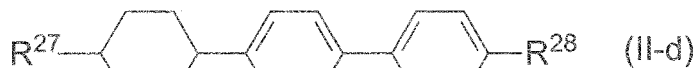
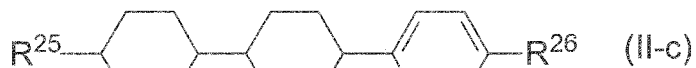
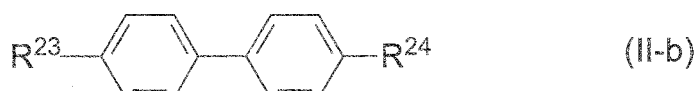

(in the formulae, R^{21} to R^{30} each independently represent an alkyl group having 1 to 10 carbon atoms or an alkenyl group having 2 to 10 carbon atoms, and X^{21} represents a hydrogen atom or a fluorine atom).

[0020] In the general formula (I), when a ring structure to which R^{31} is bonded is a phenyl group (aromatic group), R^{31}

is preferably a linear alkyl group having 1 to 5 carbon atoms, a linear alkoxy group having 1 to 4 carbon atoms (or more), or an alkenyl group having 4 to 5 carbon atoms, while when a ring structure to which R^{31} is bonded is a saturated ring structure such as cyclohexane, pyran, dioxane, or the like, R^{31} is preferably a linear alkyl group having 1 to 5 carbon atoms, a linear alkoxy group having 1 to 4 carbon atoms (or more), or a linear alkenyl group having 2 to 5 carbon atoms.

[0021] Considering good chemical stability to heat and light to be important, R^{31} is preferably an alkyl group. Considering it important to form a liquid crystal display device having low viscosity and high response speed, R^{31} is preferably an alkenyl group. Further, for the purpose of achieving low viscosity, a high nematic-isotropic phase transition temperature (T_{ni}), and higher response speed, an alkenyl group without an unsaturated bond at an end is preferably used, and an alkenyl group having a methyl group as an adjacent terminal group is particularly preferred. In addition, considering good solubility at a low temperature to be important, a countermeasure is to select an alkoxy group as R^{31} . Another countermeasure is to combine many types of R^{31} . For example, it is preferred as R^{31} to combine compounds having alkyl groups or alkenyl groups having 2, 3, and 4 carbon atoms, compounds having 3 and 5 carbon atoms, or compounds having 3, 4, and 5 carbon atoms.

[0022] M^{31} to M^{33} are preferably the following.

[Chem. 5]

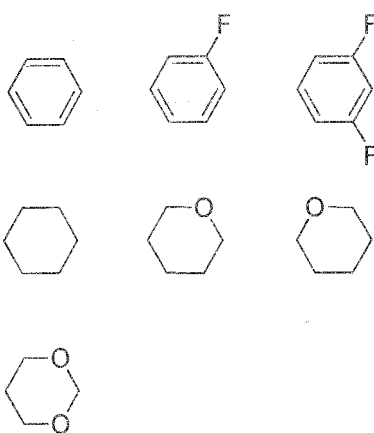

[0023] M^{31} is preferably the following,

[Chem. 6]



and more preferably the following.

[Chem. 7]

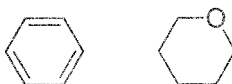

[0024] M^{32} is preferably the following,

[Chem. 8]

5

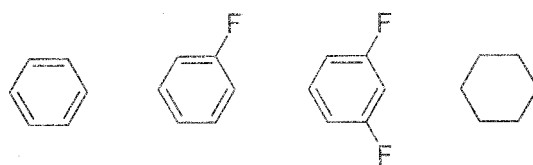

more preferably the following,

10

[Chem. 9]

15

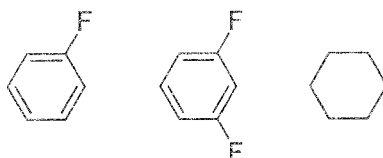

and still more preferably the following.

20

[Chem. 10]

25

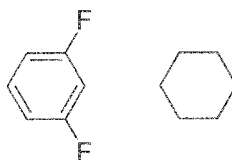

[0025] M^{33} is preferably the following,

30

[Chem. 11]

35

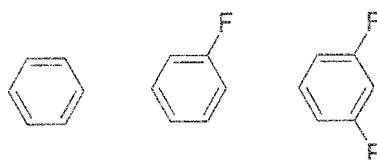

40

more preferably the following,

45

[Chem. 12]

50

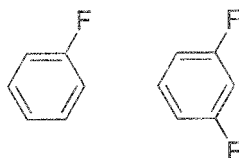

and still more preferably the following.

55

[Chem. 13]



10 At least one of X^{31} and X^{32} is preferably a fluorine atom, and more preferably both are fluorine atoms.

[0026] Z^{31} is preferably a fluorine atom or a trifluoromethoxy group. With respect to a combination of X^{31} , X^{32} , and Z^{31} , in an embodiment, $X^{31} = F$, $X^{32} = F$, and $Z^{31} = F$. In another embodiment, $X^{31} = F$, $X^{32} = H$, and $Z^{31} = F$. In a further embodiment, $X^{31} = F$, $X^{32} = H$, and $Z^{31} = OCF_3$. In a further embodiment, $X^{31} = F$, $X^{32} = F$, and $Z^{31} = OCF_3$. In a further embodiment, $X^{31} = H$, $X^{32} = H$, and $Z^{31} = OCF_3$.

15 **[0027]** n^{31} is preferably 1 or 2, n^{32} is preferably 0 or 1 and more preferably 0, and $n^{31} + n^{32}$ is preferably 1 or 2 and more preferably 2.

[0028] Preferred examples of the compound represented by the general formula (I) include compounds represented by general formula (I-a) to general formula (I-f) below.

20

[Chem. 14]

25

30

35

40

45

50

55

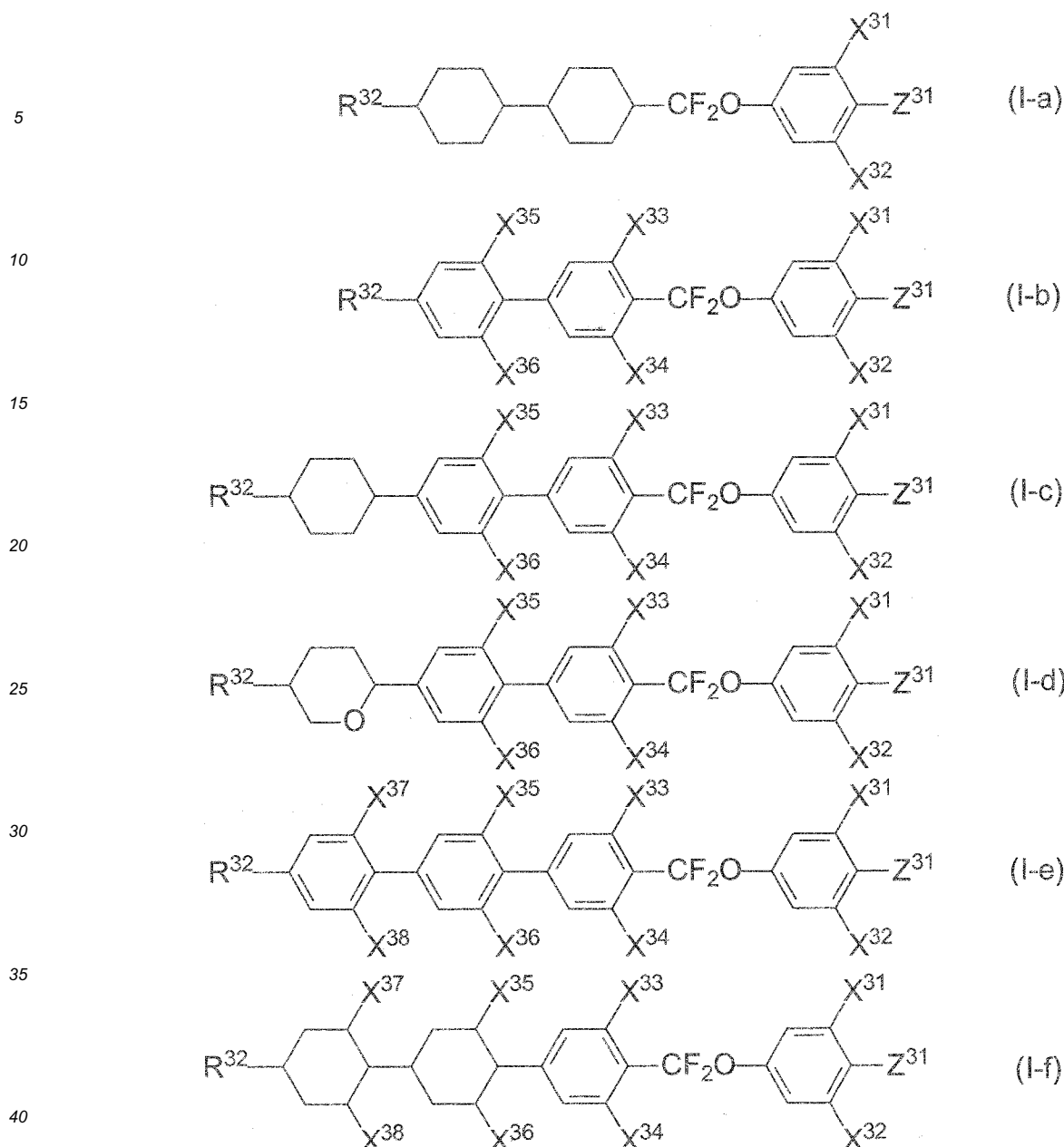

(In the formulae, R^{32} represents an alkyl group having 1 to 10 carbon atoms, an alkoxy group, or an alkenyl group or alkenyloxy group having 2 to 10 carbon atoms, X^{31} to X^{38} each independently represent a hydrogen atom or a fluorine atom, and Z^{31} represents a fluorine atom, a trifluoromethoxy group, or a trifluoromethyl group.)

[0029] In the general formula (Ia) to general formula (If), when a ring structure to which R^{32} is bonded is a phenyl group (aromatic group), R^{32} is preferably a linear alkyl group having 1 to 5 carbon atoms, a linear alkoxy group having 1 to 4 carbon atoms (or more), or an alkenyl group having 4 to 5 carbon atoms, while when a ring structure to which R^{32} is bonded is a saturated ring structure such as cyclohexane, pyran, dioxane, or the like, R^{32} is preferably a linear alkyl group having 1 to 5 carbon atoms, a linear alkoxy group having 1 to 4 carbon atoms (or more), or a linear alkenyl group having 2 to 5 carbon atoms.

[0030] Considering good chemical stability to heat and light to be important, R^{31} is preferably an alkyl group. Considering it important to form a liquid crystal display device having low viscosity and high response speed, R^{31} is preferably an alkenyl group. Further, for the purpose of achieving low viscosity, a high nematic-isotropic phase transition temperature (T_{ni}), and higher response speed, an alkenyl group without an unsaturated bond at an end is preferably used, and an alkenyl group having a methyl group as an adjacent terminal group is particularly preferred. In addition, considering good solubility at a low temperature to be important, a countermeasure is to select an alkoxy group as R^{31} . Another countermeasure is to combine many types of R^{31} . For example, it is preferred as R^{31} to combine compounds having

alkyl groups or alkenyl groups having 2, 3, and 4 carbon atoms, compounds having 3 and 5 carbon atoms, or compounds having 3, 4, and 5 carbon atoms.

[0031] At least one of X^{31} and X^{32} is preferably a fluorine atom, and more preferably both are fluorine atoms.

[0032] Z^{31} is preferably a fluorine atom or a trifluoromethoxy group. With respect to a combination of X^{31} , X^{32} , and Z^{31} , in an embodiment, $X^{31} = F$, $X^{32} = F$, and $Z^{31} = F$. In another embodiment, $X^{31} = F$, $X^{32} = H$, and $Z^{31} = F$. In a further embodiment, $X^{31} = F$, $X^{32} = H$, and $Z^{31} = OCF_3$. In a further embodiment, $X^{31} = F$, $X^{32} = F$, and $Z^{31} = OCF_3$. In a further embodiment, $X^{31} = H$, $X^{32} = H$, and $Z^{31} = OCF_3$.

[0033] n^{31} is preferably 1 or 2, n^{32} is preferably 0 or 1 and more preferably 0, and $n^{31} + n^{32}$ is preferably 1 or 2 and more preferably 2.

[0034] At least one of X^{33} and X^{34} is preferably a fluorine atom, and more preferably both are fluorine atoms.

[0035] At least one of X^{35} and X^{36} is preferably a fluorine atom, and X^{35} and X^{36} both of which are fluorine atoms have the effect of increasing A_s but are undesired in view of T_{ni} , solubility at a low temperature, and chemical stability of a liquid crystal display device.

[0036] At least one of X^{37} and X^{38} is preferably a hydrogen atom, and preferably both are hydrogen atoms. X^{37} and X^{38} at least one of which is a fluorine atom are undesired in view of T_{ni} , solubility at a low temperature, and chemical stability of a liquid crystal display device.

[0037] The compound group represented by the general formula (I) preferably includes 1 to 8 types and particularly preferably 1 to 5 types, and the content is preferably 3 to 50% by mass and more preferably 5 to 40% by mass.

[0038] In the general formula (IIa) to general formula (IIe), when a ring structure to which each of R^{21} to R^{30} is bonded is a phenyl group (aromatic group), R^{21} to R^{30} are each preferably a linear alkyl group having 1 to 5 carbon atoms, a linear alkoxy group having 1 to 4 carbon atoms (or more), or an alkenyl group having 4 to 5 carbon atoms, while when a ring structure to which each of R^{21} to R^{30} is bonded is a saturated ring structure such as cyclohexane, pyran, dioxane, or the like, R^{21} to R^{30} are each preferably a linear alkyl group having 1 to 5 carbon atoms, a linear alkoxy group having 1 to 4 carbon atoms (or more), or a linear alkenyl group having 2 to 5 carbon atoms.

[0039] Considering good chemical stability to heat and light to be important, R^{21} to R^{30} are each preferably an alkyl group. Considering it important to form a liquid crystal display device having low viscosity and high response speed, R^{21} to R^{30} are each preferably an alkenyl group. Further, for the purpose of achieving low viscosity, a high nematic-isotropic phase transition temperature (T_{ni}), and higher response speed, an alkenyl group without an unsaturated bond at an end is preferably used, and an alkenyl group having a methyl group as an adjacent terminal group is particularly preferred. In addition, considering good solubility at a low temperature to be important, a countermeasure is to select an alkoxy group as each of R^{21} to R^{30} . Another countermeasure is to combine many types of R^{21} to R^{30} . For example, it is preferred as R^{21} to R^{30} to combine compounds having alkyl groups or alkenyl groups having 2, 3, and 4 carbon atoms, compounds having 3 and 5 carbon atoms, or compounds having 3, 4, and 5 carbon atoms.

[0040] R^{21} and R^{22} are each preferably an alkyl group or an alkenyl group, and at least one of R^{21} and R^{22} is preferably an alkenyl group. R^{21} and R^{22} both of which are alkenyl groups are preferably used for increasing the response speed but are undesired for improving chemical stability of a liquid crystal display device.

[0041] At least one of R^{23} and R^{24} is preferably an alkyl group, an alkoxy group, or an alkenyl group having 4 to 5 carbon atoms. In order to achieve good balance between the response speed and T_{ni} , at least one of R^{23} and R^{24} is preferably an alkenyl group, while in order to achieve good balance between the response speed and solubility at a low temperature, at least one of R^{23} and R^{24} is preferably an alkoxy group.

[0042] At least one of R^{25} and R^{26} is preferably an alkyl group, an alkoxy group, or an alkenyl group having 2 to 5 carbon atoms. In order to achieve good balance between the response speed and T_{ni} , at least one of R^{25} and R^{26} is preferably an alkenyl group, while in order to achieve good balance between the response speed and solubility at a low temperature, at least one of R^{25} and R^{26} is preferably an alkoxy group. R^{25} and R^{26} are more preferably an alkenyl group and an alkyl group, respectively. Also, R^{25} and R^{26} are preferably an alkyl group and an alkoxy group, respectively.

[0043] At least one of R^{27} and R^{28} is preferably an alkyl group, an alkoxy group, or an alkenyl group having 2 to 5 carbon atoms. In order to achieve good balance between the response speed and T_{ni} , at least one of R^{27} and R^{28} is preferably an alkenyl group, while in order to achieve good balance between the response speed and solubility at a low temperature, at least one of R^{27} and R^{28} is preferably an alkoxy group. R^{27} and R^{28} are more preferably an alkyl or alkenyl group and an alkyl group, respectively. Also, R^{27} and R^{28} are preferably an alkyl group and an alkoxy group, respectively. Further, R^{27} and R^{28} are particularly preferably an alkyl group and an alkyl group, respectively.

[0044] x^{21} is preferably a fluorine atom.

[0045] The compound group represented by the general formula (II-a) to general formula (II-e) preferably includes 1 to 10 types and particularly preferably 1 to 8 types, and the content is preferably 5 to 80% by mass, more preferably 10 to 70% by mass, and particularly preferably 20 to 60% by mass.

[0046] The liquid crystal composition layer in the liquid crystal display device according to the present invention can further contain at least one compound selected from the compound group represented by general formula (III-a) to general formula (III-f).

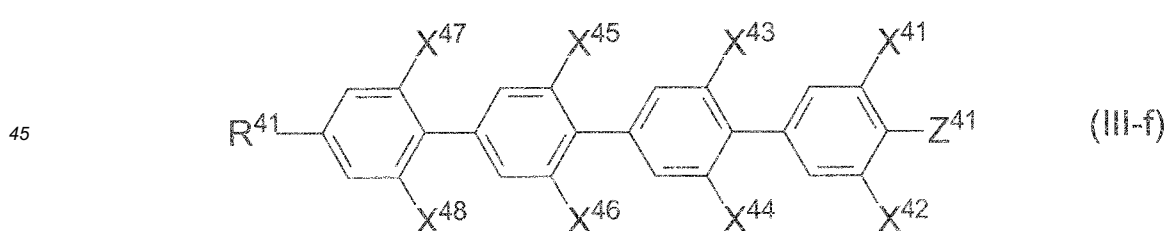
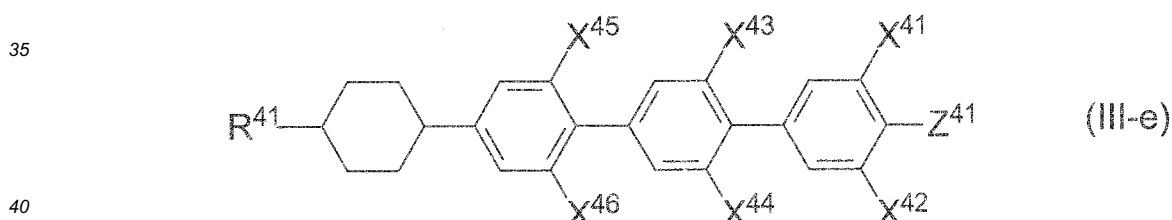
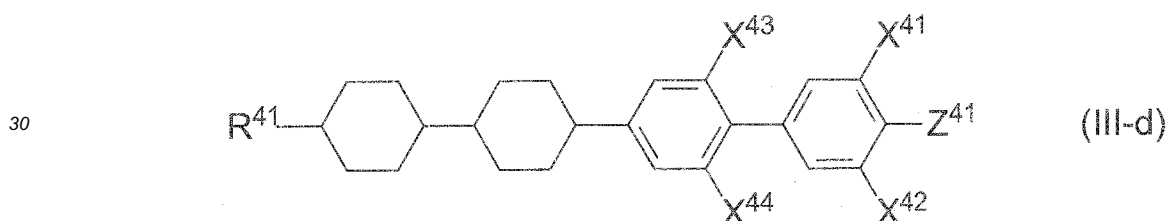
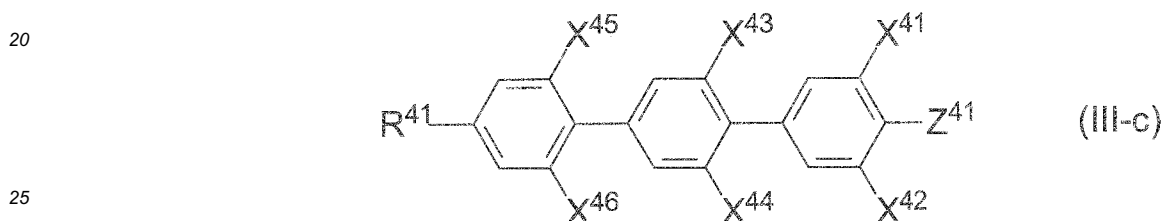
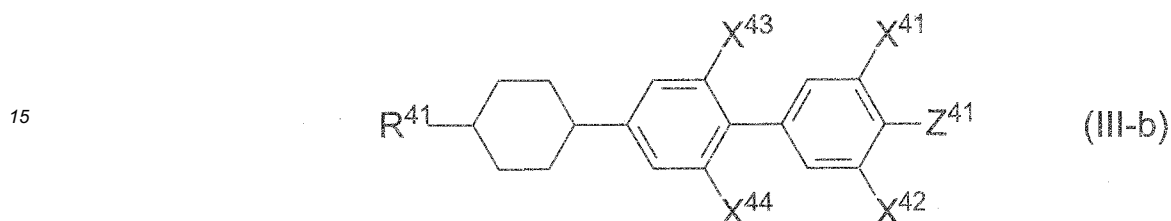
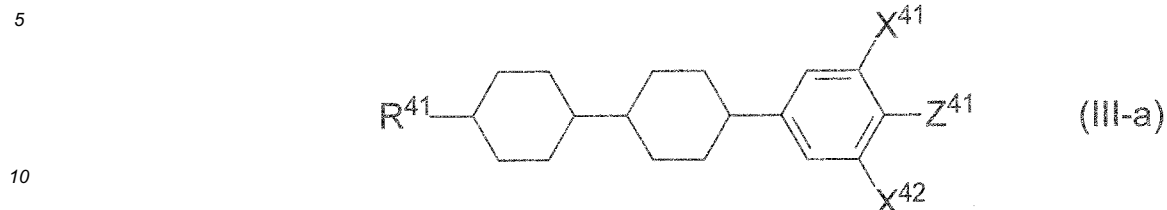

50 (In the formulae, R⁴¹ represents an alkyl group having 1 to 10 carbon atoms, an alkoxy group, or an alkenyl group or alkenyloxy group having 2 to 10 carbon atoms, X⁴¹ to X⁴⁸ each independently represent a hydrogen atom or a fluorine atom, and Z⁴¹ represents a fluorine atom, a trifluoromethoxy group, or a trifluoromethyl group.)

55 **[0047]** In the general formula (IIIa) to general formula (III-f), when a ring structure to which R⁴¹ is bonded is a phenyl group (aromatic group), R⁴¹ is preferably a linear alkyl group having 1 to 5 carbon atoms, a linear alkoxy group having 1 to 4 carbon atoms (or more), or an alkenyl group having 4 to 5 carbon atoms, while when a ring structure to which R⁴¹ is bonded is a saturated ring structure such as cyclohexane, pyran, dioxane, or the like, R⁴¹ is preferably a linear alkyl group having 1 to 5 carbon atoms, a linear alkoxy group having 1 to 4 carbon atoms (or more), or a linear alkenyl group

having 2 to 5 carbon atoms.

[0048] Considering good chemical stability to heat and light to be important, R⁴¹ is preferably an alkyl group. Considering it important to form a liquid crystal display device having low viscosity and high response speed, R⁴¹ is preferably an alkenyl group. Further, for the purpose of achieving low viscosity, a high nematic-isotropic phase transition temperature (T_{ni}), and higher response speed, an alkenyl group without an unsaturated bond at an end is preferably used, and an alkenyl group having a methyl group as an adjacent terminal group is particularly preferred. In addition, considering good solubility at a low temperature to be important, a countermeasure is to select an alkoxy group as R⁴¹. Another countermeasure is to combine many types of R⁴¹. For example, it is preferred as R⁴¹ to combine compounds having alkyl groups or alkenyl groups having 2, 3, and 4 carbon atoms, compounds having 3 and 5 carbon atoms, or compounds having 3, 4, and 5 carbon atoms.

[0049] At least one of X⁴¹ and X⁴² is preferably a fluorine atom, and more preferably both are fluorine atoms.

[0050] Z⁴¹ is preferably a fluorine atom or a trifluoromethoxy group. With respect to a combination of X⁴¹, X⁴², and Z⁴¹, in an embodiment, X⁴¹ = F, X⁴² = F, and Z⁴¹ = F. In another embodiment, X⁴¹ = F, X⁴² = H, and Z⁴¹ = F. In a further embodiment, X⁴¹ = F, X⁴² = H, and Z⁴¹ = OCF₃. In a further embodiment, X⁴¹ = F, X⁴² = F, and Z⁴¹ = OCF₃. In a further embodiment, X⁴¹ = H, X⁴² = H, and Z⁴¹ = OCF₃.

[0051] At least one of X⁴³ and X⁴⁴ is preferably a fluorine atom, and more preferably both are fluorine atoms, and X⁴³ and X⁴⁴ both of which are fluorine atoms are preferred for achieving high Δε but are conversely undesired for improving solubility at a low temperature.

[0052] At least one of X⁴⁵ and X⁴⁶ is preferably a hydrogen atom, and preferably both are hydrogen atoms. The use of a large number of fluorine atoms is undesired in view of T_{ni}, solubility at a low temperature, and chemical stability of a liquid crystal display device.

[0053] At least one of X⁴⁷ and X⁴⁸ is preferably a hydrogen atom, and preferably both are hydrogen atoms. X⁴⁷ and X⁴⁸ at least one of which is a fluorine atom are undesired in view of T_{ni}, solubility at a low temperature, and chemical stability of a liquid crystal display device.

[0054] The compound selected from the compound group represented by the general formula (III-a) to general formula (III-f) preferably includes 1 to 10 types and particularly preferably 1 to 8 types, and the content is preferably 5 to 50% by mass and more preferably 10 to 40% by mass.

[0055] The liquid crystal composition of the liquid crystal composition layer in the liquid crystal display device according to the present invention preferably has a Δε at 25°C of +3.5 or more and more preferably +3.5 to +15.0. Also, Δn at 25°C is preferably 0.08 to 0.14 and more preferably 0.09 to 0.13. In further detail, in correspondence with a thin cell gap, Δn at 25°C is preferably 0.10 to 0.13, while in correspondence with a thick cell gap, Δn at 25°C is preferably 0.08 to 0.10. In addition, η at 20°C is preferably 10 to 45 mPa·s, more preferably 10 to 25 mPa·s, and particularly preferably 10 to 20 mPa·s. Further, T_{ni} is preferably 60°C to 120°C, more preferably 70°C to 100°C, and particularly preferably 70°C to 85°C.

[0056] Besides the above-described compounds, the liquid crystal composition of the present invention may further contain a usual nematic liquid crystal, smectic liquid crystal, cholesteric liquid crystal, or the like.

[0057] In order to manufacture a liquid crystal display device of a PS mode or a lateral electric field-type PSA mode or lateral electric field-type PSVA mode, the liquid crystal composition of the present invention can contain at least one polymerizable compound. Usable examples of the polymerizable compound include photopolymerizable monomers which promote polymerization by energy rays such as light, and examples of a structure include those of polymerizable compounds such as biphenyl derivatives, terphenyl derivatives, and the like, which have a liquid crystal skeleton including a plurality of 6-member rings connected to each other. Preferred examples thereof include difunctional monomers represented by general formula (V),

[Chem. 16]

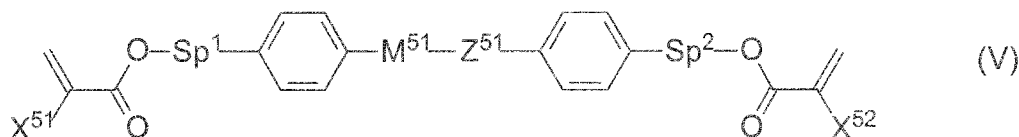

(in the formula, X⁵¹ and X⁵² each independently represent a hydrogen atom or a methyl group, Sp¹ and Sp² each independently represent a single bond, an alkylene group having 1 to 8 carbon atoms, or -O-(CH₂)_s- (wherein s represents an integer of 2 to 7, and an oxygen atom is bonded to an aromatic ring), Z⁵¹ represents -OCH₂-, -CH₂O-, -COO-, -OCO-, -CF₂O-, -OCF₂-, -CH₂CH₂-, -CF₂CF₂-, -CH=CH-COO-, -CH=CH-OCO-, -COO-CH=CH-, -OCO-CH=CH-, -COO-CH₂CH₂-, -OCO-CH₂CH₂-, -CH₂CH₂-COO-, -CH₂CH₂-OCO-, -COO-CH₂-, -OCO-CH₂-, -CH₂-COO-, -CH₂-OCO-, -CY¹=CY²- (wherein Y¹ and Y² each independently represent a fluorine atom or a hydrogen atom), -C≡C-, or a single bond, M⁵¹ represents a 1,4-phenylene group, a trans-1,4-cyclohexylene group, or a single bond, and any desired

hydrogen atoms of any 1,4-phenylene group in the formula may be substituted by fluorine atoms).

[0058] Also, any one of a diacrylate derivative in which X^{51} and X^{52} both represent hydrogen atoms and a dimethacrylate derivative in which X^{51} and X^{52} both represent methyl groups, and a compound in which one of X^{51} and X^{52} represents a hydrogen atom, and the other represents a methyl group are preferred. Among these compounds, the diacrylate derivative has the highest polymerization rate, the dimethacrylate derivative has a low polymerization rate, and the asymmetric compound has a medium polymerization rate between them. A preferred form can be used according to application. In particular, the dimethacrylate derivative is preferred for a PSA display device.

[0059] Sp^1 and Sp^2 each independently represent a single bond, an alkylene group having 1 to 8 carbon atoms, or $-O-(CH_2)_s-$, but at least one of Sp^1 and Sp^2 is preferably a single bond for a PSA display device. A preferred compound has a form in which Sp^1 and Sp^2 both represent single bonds, or one of Sp^1 and Sp^2 represents a single bond and the other represents an alkylene group having 1 to 8 carbon atoms or $-O-(CH_2)_s-$. In this case, an alkyl group having 1 to 4 carbon atoms is preferred, and s is preferably 1 to 4.

[0060] Z^{51} is preferably $-OCH_2-$, $-CH_2O-$, $-COO-$, $-OCO-$, $-CF_2O-$, $-OCF_2-$, $-CH_2CH_2-$, $-CF_2CF_2-$, or a single bond, more preferably $-COO-$, $-OCO-$, or a single bond, and particularly preferably a single bond.

[0061] M^{51} represents a 1,4-phenylene group in which any hydrogen atom may be substituted by a fluorine atom, a trans-1,4-cyclohexylene group, or a single bond, but a 1,4-phenylene group or a single bond is preferred. When C represents a ring structure other than a single bond, Z^{51} is preferably a linkage group other than a single bond, and when M^{51} is a single bond, Z^{51} is preferably a single bond.

[0062] Specifically, in view of these points, in the general formula (V), a ring structure present between Sp^1 and Sp^2 is preferably a structure described below.

[0063] In the general formula (V), when M^{51} represents a single bond, and the ring structure includes two rings, the ring structure is preferably represented by formula (Va-1) to formula (Va-5), more preferably formula (Va-1) to formula (Va-3), and particularly preferably formula (Va-1).

[Chem. 17]

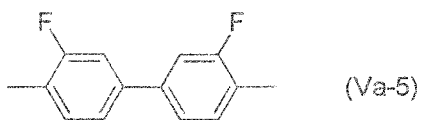
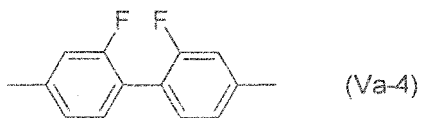
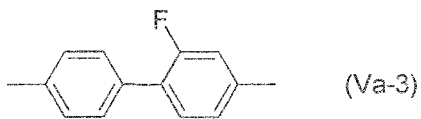
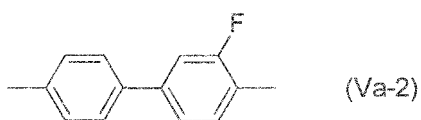
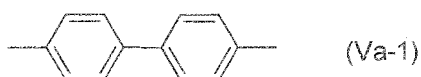

(In the formulae, both ends are bonded to Sp^1 or Sp^2 .)

[0064] The polymerizable compounds having the skeletons have, after polymerization, alignment regulating force which is optimum for a PSA-mode liquid crystal display device, and produce a good alignment state, thereby suppressing display unevenness or causing no display unevenness.

[0065] In view of the above, polymerizable compounds of general formula (V-1) to general formula (V-4) are particularly preferred, and a polymerizable compound of the general formula (V-2) is most preferred.

[Chem. 18]

5

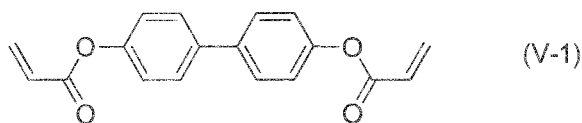

10

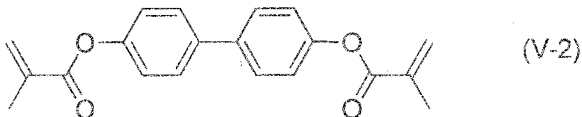

15

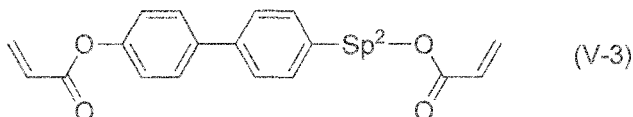

20

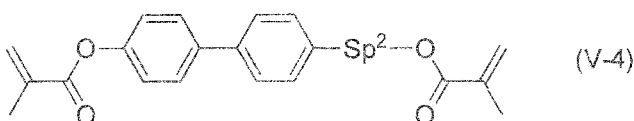

(In the formulae, Sp^2 represents an alkylene group having 2 to 5 carbon atoms.)

25 **[0066]** When the polymerizable compound is added to the liquid crystal composition according to the present invention, polymerization proceeds in the absence of a polymerization initiator, but a polymerization initiator may be added for promoting polymerization. Examples of the polymerization initiator include benzoin ethers, benzophenones, acetophenones, benzylketals, acylphosphine oxides, and the like.

30 **[0067]** The liquid crystal composition containing the polymerizable compound according to the present invention is imparted with a liquid crystal alignment ability when the polymerizable compound contained is polymerized by ultraviolet irradiation, and is used for a liquid crystal display device in which a quantity of transmitted light is controlled by using birefringence of the liquid crystal composition. The present invention is useful for the liquid crystal display device such as AM-LCD (active matrix liquid crystal display device), TN (nematic liquid crystal display device), STN-LCD (super twisted nematic liquid crystal display device), and OCB-LCD and IPS-LCD (in-plane switching liquid crystal display device), but the present invention is particularly useful for AM-LCD and can be used for a transmissive or reflective liquid crystal display device.

(Color filter)

40 **[0068]** A color filter according to the present invention includes a black matrix and at least RGB three-color pixel portions, the RGB three-color pixel portions including, as colorants, a diketopyrrolopyrrole pigment and/or anionic red organic dye in a R pixel portion, at least one selected from the group consisting of a halogenated copper phthalocyanine pigment, a phthalocyanine green dye, and a mixture of a phthalocyanine blue dye and an azo yellow organic dye in a G pixel portion, and a ϵ -type copper phthalocyanine pigment and/or cationic blue organic dye in a B pixel portion.

45 **[0069]** The RGB three-color pixel portions preferably include, as a colorant, C. I. Solvent Red 124 or C. I. Pigment Red 254 in the R pixel portion.

[0070] The RGB three-color pixel portions preferably include, as a colorant, a mixture of C. I. Solvent Blue 67 and C. I. Solvent Yellow 162 or C. I. Pigment Green 7 and/or 36 in the G pixel portion.

50 **[0071]** The RGB three-color pixel portions preferably include, as a colorant, C. I. Solvent Blue 7 or C. I. Pigment Blue 15:6 in the B pixel portion.

[0072] The RGB three-color pixel portions preferably include, as colorants, C. I. Solvent Red 124 in the R pixel portion, a mixture of C. I. Solvent Blue 67 and C. I. Solvent Yellow 162 in the G pixel portion, and C. I. Solvent Blue 7 in the B pixel portion.

[0073] Also, the RGB three-color pixel portions preferably include, as colorants, C. I. Pigment Red 254 in the R pixel portion, C. I. Pigment Green 7 and/or 36 in the G pixel portion, and C. I. Pigment Blue 15:6 in the B pixel portion.

[0074] The RGB three-color pixel portions preferably further include, as a colorant in the R pixel portion, at least one organic dye/pigment selected from the group consisting of C. I. Pigment Red 177, 242, 166, 167, and 179, C. I. Pigment Orange 38 and 71, C. I. Pigment Yellow 150, 215, 185, 138, and 139, C. I. Solvent Red 89, C. I. Solvent Orange 56,

and C. I. Solvent Yellow 21, 82, 83:1, 33, and 162.

[0075] The RGB three-color pixel portions preferably include, as a colorant in the G pixel portion, at least one organic dye/pigment selected from the group consisting of C. I. Pigment Yellow 150, 215, 185, and 138, and C. I. Solvent Yellow 21, 82, 83:1, and 33.

[0076] The RGB three-color pixel portions preferably further include, as a colorant in the B pixel portion, at least one organic dye/pigment selected from the group consisting of C. I. Pigment Blue 1, C. I. Pigment Violet 23, C. I. Basic Blue 7, C. I. Basic Violet 10, C. I. Acid Blue 1, 90, and 83, and C. I. Direct Blue 86.

[0077] A color filter includes a black matrix, RGB three-color pixel portions, and a Y pixel portion, and preferably contains, as a colorant in the Y pixel portion, at least one yellow organic dye/pigment selected from the group consisting of C. I. Pigment Yellow 150, 215, 185, 138, and 139, and C. I. Solvent Yellow 21, 82, 83:1, 33, and 162.

[0078] From the viewpoint of preventing a decrease in voltage holding ratio (VHR) of the liquid crystal layer an increase in ion density (ID) and suppressing the occurrence of the problems of display defects such as white spots, alignment unevenness, image sticking, and the like, each of the pixel portions in the color filter according to the present invention preferably has chromaticity x and chromaticity y in the XYZ color coordinate system under a C light source as described below.

[0079] The R pixel portion preferably has, in the XYZ color coordinate system under the C light source, a chromaticity x of 0.58 to 0.69 and more preferably 0.62 to 0.68, and a chromaticity y of 0.30 to 0.36 and more preferably 0.31 to 0.35. Preferably, the chromaticity x is 0.58 to 0.69 and the chromaticity y is 0.30 to 0.36, and more preferably, the chromaticity x is 0.62 to 0.68 and the chromaticity y is 0.31 to 0.35.

[0080] The G pixel portion preferably has, in the XYZ color coordinate system under the C light source, a chromaticity x of 0.19 to 0.35 and more preferably 0.20 to 0.26, and a chromaticity y of 0.54 to 0.74 and more preferably 0.64 to 0.73. Preferably, the chromaticity x is 0.19 to 0.35 and the chromaticity y is 0.54 to 0.74, and more preferably, the chromaticity x is 0.20 to 0.26 and the chromaticity y is 0.64 to 0.73.

[0081] The B pixel portion preferably has, in the XYZ color coordinate system under the C light source, a chromaticity x of 0.11 to 0.16 and more preferably 0.12 to 0.15, and a chromaticity y of 0.04 to 0.15 and more preferably 0.05 to 0.10. Preferably, the chromaticity x is 0.11 to 0.16 and the chromaticity y is 0.04 to 0.15, and more preferably, the chromaticity x is 0.12 to 0.15 and the chromaticity y is 0.05 to 0.10.

[0082] The Y pixel portion preferably has, in the XYZ color coordinate system under the C light source, a chromaticity x of 0.46 to 0.50 and more preferably 0.47 to 0.48, and a chromaticity y of 0.48 to 0.53 and more preferably 0.50 to 0.52. Preferably, the chromaticity x is 0.46 to 0.50 and the chromaticity y is 0.48 to 0.53, and more preferably, the chromaticity x is 0.47 to 0.48 and the chromaticity y is 0.50 to 0.52.

[0083] Here, the XYZ color coordinate system is a color coordinate system approved as a standard color coordinate system by CIE (International Commission on Illumination) in 1931.

[0084] The chromaticity of each of the pixel portions can be adjusted by changing the type of the dye/pigment used and a mixing ratio thereof. For example, the chromaticity in a R pixel can be adjusted by adding a proper amount of yellow dye/pigment and/or orange pigment to a red dye/pigment, the chromaticity in a G pixel can be adjusted by adding a proper amount of yellow dye/pigment to a green dye/pigment, and the chromaticity in a B pixel can be adjusted by adding a proper amount of violet dye/pigment to a blue dye/pigment. Also, the chromaticity can be adjusted by appropriately adjusting the particle diameter of a pigment.

[0085] In the color filter, the color filter pixel portions can be formed by a generally known method. A typical method for forming pixel portions is a photolithography method in which a photocurable composition described below is applied to a surface of a color filter transparent substrate on the side provided with a black matrix and then dried by heating (prebaked), the photocurable compound is cured in portions corresponding to the pixel portions by pattern exposure under irradiation with ultraviolet light through a photomask, unexposed portions are developed with a developer, and then non-pixel portions are removed to fix the pixel portions to the transparent substrate. This method forms the pixel portions each composed of a cured color film of the photocurable composition on the transparent substrate.

[0086] A photocurable composition described below is prepared for each of R pixels, G pixels, B pixels, and if required, other color pixels such as Y pixels or the like, and the above-described operation is repeated to produce a color filter having color pixel portions of the R pixels, G pixels, B pixels, and Y pixels at predetermined positions.

[0087] Examples of a method for applying each photocurable composition described below to the transparent substrate of glass or the like include a spin coating method, a roll coating method, an ink jet method, and the like.

[0088] The drying conditions of a coating film of the photocurable composition applied to the transparent substrate are generally 50°C to 150°C and about 1 to 15 minutes, depending on the type and mixing ratio of each component, or the like. Light used for photocuring the photocurable composition is preferably ultraviolet light within a wavelength region of 200 to 500 nm or visible light. Various light sources which emit light within this wavelength region can be used.

[0089] Examples of a development method include a puddle method, a dipping method, a spray method, and the like. After exposure and development of the photocurable composition, the transparent substrate on which necessary color pixel portions have been formed is washed with water and dried. The resultant color filter is heat-treated (post baked)

at 90°C to 280°C for a predetermined time using a heating apparatus such as a hot plate, an oven, or the like to remove volatile components in the color coating film and, at the same time, to heat-cure an unreacted photocurable compound remaining in the cured color coating film of the photocurable composition, completing the color filter. Also, a color filter-on-array structure including a color filter formed on a pixel substrate can be formed.

[0090] By using the colorants for the color filter of the present invention in combination with the liquid crystal composition of the present invention, it is possible to provide a liquid crystal display device capable of preventing a decrease in voltage holding ratio (VHR) of the liquid crystal layer and an increase in ion density (ID) and resolving the problem of display defects such as white spots, alignment unevenness, image sticking, and the like.

[0091] A method for producing the photocurable composition is generally a method in which a dye and/or pigment composition for the color filter of the present invention, an organic solvent, and a dispersant are used as essential components, these components are mixed and uniformly dispersed by stirring to prepare a pigment dispersion for forming a pixel portion of the color filter, and a photocurable compound and, if required, a thermoplastic resin, a photopolymerization initiator, and the like are added to the dispersion to produce the photocurable composition.

[0092] Examples of the organic solvent used include aromatic solvents such as toluene, xylene, methoxybenzene, and the like; acetic acid ester solvents such as ethyl acetate, propyl acetate, butyl acetate, propylene glycol monomethyl ether acetate, propylene glycol monoethyl ether acetate, diethylene glycol methyl ether acetate, diethylene glycol ethyl ether acetate, diethylene glycol propyl ether acetate, diethylene glycol butyl ether acetate, and the like; propionate solvents such as ethoxyethyl propionate, and the like; alcohol solvents such as methanol, ethanol, and the like; ether solvents such as butyl cellosolve, propylene glycol monomethyl ether, diethylene glycol ethyl ether, diethylene glycol dimethyl ether, and the like; ketone solvents such as methyl ethyl ketone, methyl isobutyl ketone, cyclohexanone, and the like; aliphatic hydrocarbon solvents such as hexane and the like; nitrogen compound solvents such as N,N-dimethylformamide, γ -butyrolactam, N-methyl-2-pyrrolidone, aniline, pyridine, and the like; lactone solvents such as γ -butyrolactone and the like; and carbamic acid esters such as a mixture of methyl carbamate and ethyl carbamate at 48:52, and the like.

[0093] Examples of the dispersant which can be used include dispersants such as BYK Chemie DISPERBYK 130, DISPERBYK 161, DISPERBYK 162, DISPERBYK 163, DISPERBYK 170, DISPERBYK 171, DISPERBYK 174, DISPERBYK 180, DISPERBYK 182, DISPERBYK 183, DISPERBYK 184, DISPERBYK 185, DISPERBYK 2000, DISPERBYK 2001, DISPERBYK 2020, DISPERBYK 2050, DISPERBYK 2070, DISPERBYK 2096, DISPERBYK 2150, DISPERBYK LPN21116, and DISPERBYK LPN6919; Efka Chemicals Company Efka 46, Efka 47, Efka 452, Efka LP4008, Efka 4009, Efka LP4010, Efka LP4050 and LP4055, Efka 400, Efka 401, Efka 402, Efka 403, Efka 450, Efka 451, Efka 453, Efka 4540, Efka 4550, Efka LP4560, Efka 120, Efka 150, Efka 1501, Efka 1502, and Efka 1503; Lubrizol Corporation Solsperser 3000, Solsperser 9000, Solsperser 13240, Solsperser 13650, Solsperser 13940, Solsperser 17000 and 18000, Solsperser 20000, Solsperser 21000, Solsperser 20000, Solsperser 24000, Solsperser 26000, Solsperser 27000, Solsperser 28000, Solsperser 32000, Solsperser 36000, Solsperser 37000, Solsperser 38000, Solsperser 41000, Solsperser 42000, Solsperser 43000, Solsperser 46000, Solsperser 54000, and Solsperser 71000; and Ajimonoto Co., Ltd. Ajisper PB711, Ajisper PB821, Ajisper PB822, Ajisper PB814, Ajisper PN411, and Ajisper PA111; and synthetic resins which are liquid at room temperature and water-insoluble, such as acryl resins, urethane resins, alkyd resins, natural rosins such as wood rosin, gum rosin, tall oil rosin, and the like, modified rosins such as polymerized rosin, disproportionated rosin, hydrogenated rosin, oxidized rosin, maleinized rosin, and the like, rosin derivatives such as rosin amine, lime rosin, rosin alkyleneoxide adduct, rosin alkyd adduct, rosin-modified phenol, and the like. Addition of any one of the dispersants and resins contributes to a decrease in flocculation and improvements in dispersion stability of pigments and viscosity characteristics of the dispersant.

[0094] Examples of a dispersion aid which can be used include organic pigment derivatives such as phthalimide methyl derivatives, sulfonic acid derivatives, N-(dialkylamino)methyl derivative, N-(dialkylaminoalkyl)sulfonic amide derivatives, and the like. Of course, these derivatives can be used in combination of two or more different types.

[0095] Examples of the thermoplastic resin used for preparing the photocurable composition include urethane resins, acryl resins, polyamide resins, polyimide resins, styrene-maleic acid resins, styrene-maleic anhydride resins, and the like.

[0096] Examples of the photocurable compound include difunctional monomers such as 1,6-hexanediol diacrylate, ethylene glycol diacrylate, neopentyl glycol diacrylate, triethylene glycol diacrylate, bis(acryloxyethoxy)bisphenol A, 3-methylpentanediol diacrylate, and the like; polyfunctional monomers with relatively low molecular weight, such as trimethylolpropane triacrylate, pentaerythritol triacrylate, tris[2-(meth)acryloyloxyethyl] isocyanurate, dipentaerythritol hexaacrylate, dipentaerythritol pentaacrylate, and the like; and polyfunctional monomers with relatively high molecular weight, such as polyester acrylate, polyurethane acrylate, polyether acrylate, and the like.

[0097] Examples of the photopolymerization initiator include acetophenone, benzophenone, benzyl dimethyl ketanol, benzoyl peroxide, 2-chlorothioxanthone, 1,3-bis(4'-azidobenzal)-2-propane, 1,3-bis(4'-azidobenzal)-2-propane-2'-sulfonic acid, 4,4'-diazidostilbene-2,2'-disulfonic acid, and the like. Examples of a commercially available photopolymerization initiator include BASF Corporation "Irgacure (trade name)-184", "Irgacure (trade name)-369", "Darocur (trade name)-1173", and BASF Corporation "Lucirin-TPO", Nippon Kayaku Co., Ltd. "Kayacure (trade name) DETX" and "Kay-

acure (trade name) OA", Sutoufa Chemical Co., "Baikyua 10" and "Baikyua 55", and Akzo Co., Ltd. "Trigonal PI", Sandozu Co., Ltd. "Sandorei 1000", Apujon Co., Ltd. "Deep", Kurogane Kasei Co., Ltd. "Biimidazole", and the like.

5 [0098] The photopolymerization initiator can be combined with a known photosensitizer in common use. Examples of the photosensitizer include amines, ureas, sulfur atom-containing compounds, phosphorus atom-containing compounds, chlorine atom-containing compounds, nitriles, other nitrogen atom-containing compounds, and the like. These can be used alone or in combination of two or more.

10 [0099] The ratio of the photopolymerization initiator mixed is not particularly limited but is preferably in a range of 0.1% to 30% on a mass basis relative to a compound having a photopolymerizable or photocurable functional group. With the ratio less than 0.1%, sensitivity during curing tends to be decreased, while with the ratio exceeding 30%, crystals of the photopolymerization initiator may be precipitated when a coating film of a pigment-dispersed resist is dried, thereby causing deterioration in the physical properties of the coating film.

15 [0100] By using each of the above-described materials, on a mass basis, 300 to 1000 parts of the organic solvent and 1 to 100 parts of the dispersant relative to 100 parts of the color filter dye and/or pigment composition of the present invention are uniformly dispersed by stirring to prepare the dye/pigment solution. Then, to the pigment dispersion, the thermoplastic resin and the photocurable compound in a total of 3 to 20 parts per part of the pigment composition for the color filter of the present invention, 0.05 to 3 parts of the photopolymerization initiator per part of the photocurable compound, and if required, the organic solvent are added and uniformly dispersed by stirring to produce the photocurable composition for forming each of the color filter pixel portions.

20 [0101] A known organic solvent or aqueous alkali solution in common use can be used as the developer. In particular, when the photocurable composition contains the thermoplastic resin or the photocurable compound at least one of which has an acid value and exhibits alkali solubility, washing with an aqueous alkali solution is effective for forming the color filter pixel portions.

25 [0102] Although the method for producing the color filter pixel portions by the photolithography method is described in detail, each of the color filter pixel portions prepared by using the color filter pigment composition of the present invention may be formed by another method such as an electrodeposition method, a transfer method, a micelle electrolysis method, a PVED (Photovoltaic Electrodeposition) method, an ink jet method, a reverse printing method, a heat curing method, or the like, thereby producing the color filter.

30 (Alignment film)

35 [0103] In the liquid crystal display device of the present invention, when the alignment film for aligning the liquid crystal composition is required to be provided on the surface of each of the first and second substrates which is in contact with the liquid crystal composition, the alignment film is disposed between the color filter and the liquid crystal layer. However, even in the case of a thick film, the alignment film has a thickness of as small as 100 nm or less so as not to completely cut off the interaction between the colorants such as pigments or the like, which constitute the color filter, and the liquid crystal compound constituting the liquid crystal layer.

[0104] The liquid crystal display device without using the alignment film has greater interaction between the colorants such as pigments or the like, which constitute the color filter, and the liquid crystal compound constituting the liquid crystal layer.

40 [0105] Usable examples of an alignment film material include transparent organic materials such as polyimide, polyamide, BCB (benzocyclobutene polymer), polyvinyl alcohol, and the like. In particular, it is preferred to use a polyimide alignment film produced by imidizing a polyamic-acid synthesized from diamine such as an aliphatic or alicyclic diamine, for example, p-phenylenediamine, 4,4'-diaminodiphenylmethane, or the like, and an aliphatic or alicyclic tetracarboxylic anhydride, such as butanetetracarboxylic anhydride, 2,3,5-tricarboxycyclopentylacetic anhydride, or the like, or an aromatic tetracarboxylic anhydride such as pyromellitic dianhydride or the like. In this case, rubbing is generally used as an alignment imparting method, but when the alignment film is used as a vertical alignment film, it can be used without imparting alignment.

45 [0106] A material containing a compound containing chalcone, cinnamate, cinnamoyl, or an azo group can be used as the alignment film material, and this may be used in combination with a material such as polyimide, polyamide, or the like. For this alignment film, rubbing may be used or a light alignment technique may be used.

50 [0107] The alignment film is generally formed as a resin film by applying the alignment film material to the substrate using a method such as a spin coating method or the like, but a uniaxial stretching method, a Langmuir-Blodgett method, or the like can also be used.

55 (Transparent electrode)

[0108] In the liquid crystal display device of the present invention, a conductive metal oxide can be used as a material of the transparent electrode. Usable examples of the metal oxide include indium oxide (In_2O_3), tin oxide (SnO_2), zinc

oxide (ZnO), indium-tin oxide ($\text{In}_2\text{O}_3\text{-SnO}_2$), indium-zinc oxide ($\text{In}_2\text{O}_3\text{-ZnO}$), niobium-added titanium dioxide ($\text{Ti}_{1-x}\text{Nb}_x\text{O}_2$), fluorine-doped tin oxide, graphene nanoribbons or metal nanowires, and the like. But zinc oxide (ZnO), indium-tin oxide ($\text{In}_2\text{O}_3\text{-SnO}_2$), or indium-zinc oxide ($\text{In}_2\text{O}_3\text{-ZnO}$) is preferred. The transparent conductive film can be patterned by a method such as a photo-etching method, a method using a mask, or the like.

[0109] The liquid crystal display device of the present invention is particularly useful for a liquid crystal display device for active matrix driving and can be applied to a liquid crystal display device for a TN mode, an IPS mode, a polymer-stabilized IPS mode, a FES mode, an OCB mode, a VA mode, or an ECB mode.

EXAMPLES

[0110] The present invention is described in further detail below by way of examples, but the present invention is not limited to these examples. In the examples and comparative examples below, "%" in a composition represents "% by mass".

[0111] In the examples, characteristics measured are as follows.

T_{ni} : nematic-isotropic liquid phase transition temperature (C)

Δn : refractive index anisotropy at 25°C

$\Delta \epsilon$: dielectric constant anisotropy at 25°C

η : viscosity at 20°C (mPa·s)

γ_1 : rotational viscosity at 25°C (mPa·s)

VHR: voltage holding ratio at 70°C (%)

(a value by % representing a ratio of a measured voltage to an initial applied voltage, the measured voltage being measured using a liquid crystal composition injected into a cell having a cell thickness of 3.5 μm under the conditions of 5 V applied, a frame time of 200 ms, and a pulse width of 64 μs)

ID: ion density at 70°C (pC/cm²)

(a value of ion density measured using a liquid crystal composition injected into a cell having a cell thickness of 3.5 μm and MTR-1 (manufactured by Toyo Corporation) under the conditions of 20 V applied and a frequency of 0.05 Hz)

Image sticking:

[0112] Image sticking of the liquid crystal display device was evaluated by display of a predetermined fixed pattern within a display area for 1000 hours and then uniform display over the entire screen to visually observe the level of residual image of the fixed pattern based on the following 4 levels:

A: No residual image

B: Slight residual image at an allowable level

C: Residual image at an unallowable level

D: Significant residual image

[0113] In the examples, compounds are represented by abbreviations below.

(Ring structure)

[0114]

[Chem. 19]

5

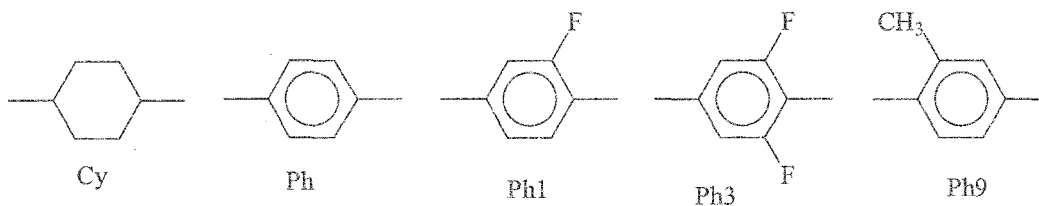

10

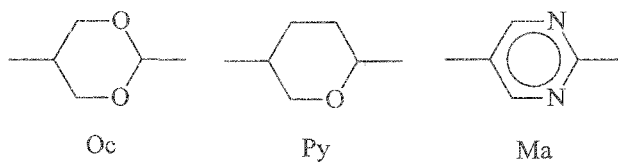

15

20

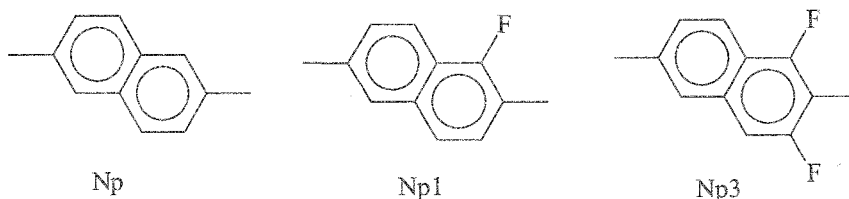

25 (Side-chain structure and linkage structure)

[Table 1]

30

35

40

45

50

55

n (number) at end	C_nH_{2n+1} -
-2-	-CH ₂ CH ₂ -
-1O-	-CH ₂ O-
-O1	-OCH ₂ -
-V-	-CO-
-VO-	-COO-
-CFFO-	-CF ₂ O-
-F	-F
-Cl	-Cl
-CN	-C≡N
-OCFFF	-OCF ₃
-CFFF	-CF ₃
-On	-OC _n H _{2n+1} -
-T-	-C≡C-
-N-	-CH=N-N=CH-
ndm-	$C_nH_{2n+1}.HC=CH-(CH_2)_{m-1}$ -
-ndm	$-(CH_2)_{n-1}HC=CH-C_mH_{2m+1}$
ndmO-	$C_nH_{2n+1}.HC=CH-(CH_2)_{m-1}O-$
-Ondm	$-O-(CH_2)_{n-1}-HC=CH-C_mH_{2m+1}$
-ndm-	$-(CH_2)_{n-1}-HC=CH-(CH_2)_{m-1}$ -

EP 2 916 167 A1

[Formation of color filter]

[Preparation of colored composition]

5 [Red dye-colored composition 1]

10 **[0115]** In a polymer bottle, 10 parts of red dye 1 (C. I. Solvent Red 124) was placed, and 55 parts of propylene glycol monomethyl ether acetate and SEPR beads of 0.3 to 0.4 mm in diameter were added, and the resultant mixture was dispersed with a paint conditioner (manufactured by Toyo Seiki Co., Ltd.) for 4 hours and then filtered through a 5 μm filter to produce a dye-colored solution. Then, 75.00 parts of the dye colored solution, 5.50 parts of polyester acrylate resin (Aronix (trade name) M7100 manufactured by Toa Gosei Chemical Industry Co., Ltd.), 5.00 parts of dipentaerythritol hexaacrylate (KAYARAD (trade name) DPHA, manufactured by Nippon Kayaku Co., Ltd.), 1.00 part of benzophenone (KAYACURE (trade name) BP-100, manufactured by Nippon Kayaku Co., Ltd.), and 13.5 parts of Ucar Ester EEP were stirred with a dispersion stirrer and then filtered with a filter having a pore size of 1.0 μm to produce red dye-colored composition 1.

[Red dye colored composition 2]

20 **[0116]** Red dye colored composition 2 was produced by the same method as described above using 8 parts of red dye 1 (C. I. Solvent Red 124) and 2 parts of yellow dye 2 (C. I. Solvent Yellow 21) in place of 10 parts of the red dye 1 of the red dye colored composition 1.

[Red dye colored composition 3]

25 **[0117]** Red dye colored composition 3 was produced by the same method as described above using 10 parts of red dye 2 (C. I. Solvent Red 1) in place of 10 parts of the red dye 1 of the red dye colored composition 1.

[Green dye colored composition 1]

30 **[0118]** Green dye colored composition 1 was produced by the same method as described above using 3 parts of blue dye 1 (C. I. Solvent Blue 67) and 7 parts of yellow dye 1 (C. I. Solvent Yellow 162) in place of 10 parts of the red dye 1 of the red dye colored composition 1.

[Green dye colored composition 2]

35 **[0119]** Green dye colored composition 2 was produced by the same method as described above using 4 parts of yellow dye 1 (C..I. Solvent Yellow 162) and 3 parts of yellow dye 3 (C. I. Solvent Yellow 82) in place of 7 parts of the yellow dye 1 of the green dye colored composition 1.

40 [Green dye colored composition 3]

[0120] Green dye colored composition 3 was produced by the same method as described above using 10 parts of green dye 1 (C. I. Solvent Green 7) in place of 3 parts of the blue dye 1 and 7 parts of the yellow dye 1 of the green dye colored composition 1.

45 [Blue dye colored composition 1]

[0121] Blue dye colored composition 1 was produced by the same method as described above using 10 parts of blue dye 1 (C. I. Solvent Blue 7) in place of 10 parts of the red dye 1 of the red dye colored composition 1.

50 [Blue dye colored composition 2]

[0122] Blue dye colored composition 2 was produced by the same method as described above using 7 parts of blue dye 1 (C. I. Solvent Blue 7) and 3 parts of violet dye 1 (C. I. Basic Violet 10) in place of 10 parts of the blue dye 1 of the blue dye colored composition 1.

55

EP 2 916 167 A1

[Blue dye colored composition 3]

5 **[0123]** Blue dye colored composition 3 was produced by the same method as described above using 10 parts of blue dye 2 (C. I. Solvent Blue 12) in place of 7 parts of the blue dye 1 and 3 parts of the violet dye 1 of the blue dye colored composition 2.

[Yellow dye colored composition 1]

10 **[0124]** Yellow dye colored composition 1 was produced by the same method as described above using 10 parts of yellow dye 2 (C. I. Solvent Yellow 21) in place of 10 parts of the red dye 1 of the red dye colored composition 1.

[Yellow dye colored composition 2]

15 **[0125]** Yellow dye colored composition 2 was produced by the same method as described above using 10 parts of yellow dye 4 (C. I. Solvent Yellow 2) in place of 10 parts of the yellow dye 2 of the yellow dye colored composition 1.

[Red pigment colored composition 1]

20 **[0126]** In a polymer bottle, 10 parts of red pigment 1 (C. I. Pigment Red 254, "IRGAPHOR RED BT-CF" manufactured by BASF Corporation) was placed, and 55 parts of propylene glycol monomethyl ether acetate, 7.0 parts of DISPERBYK LPN21116 (manufactured by BYK Chemie Corporation), and SEPR beads of 0.3 to 0.4 mm in diameter were added, and the resultant mixture was dispersed with a paint conditioner (manufactured by Toyo Seiki Co., Ltd.) for 4 hours and then filtered with a 5 μm filter to produce a pigment-colored solution. Then, 75.00 parts of the pigment-colored solution, 5.50 parts by polyester acrylate resin (Aronix (trade name) M7100, manufactured by Toa Gosei Chemical Industry Co., Ltd.), 5.00 parts of dipentaerythritol hexaacrylate (KAYARAD (trade name) DPHA, manufactured by Nippon Kayaku Co., Ltd.), 1.00 part of benzophenone (KAYACURE (trade name) BP-100, manufactured by Nippon Kayaku Co., Ltd.), and 13.5 parts of Ucar Ester EEP were stirred with a dispersion stirrer and then filtered with a filter having a pore size of 1.0 μm to produce red pigment colored composition 1.

30 [Red pigment colored composition 2]

35 **[0127]** Red pigment colored composition 2 was produced by the same method as described above using 6 parts of the red pigment 1, 2 parts of red pigment 2 (C. I. Pigment Red 177 manufactured by DIC Corporation, FASTOGEN SUPER RED ATY-TR), and 2 parts of yellow pigment 2 (C. I. Pigment Yellow 139) in place of 10 parts of the red pigment 1 of the red pigment colored composition 1.

[Green pigment colored composition 1]

40 **[0128]** Green pigment colored composition 1 was produced by the same method as described above using 6 parts of green pigment 1 (C. I. Pigment Green 36, manufactured by DIC Corporation, "FASTOGEN GREEN 2YK-CF"), and 4 parts of yellow pigment 1 (C. I. Pigment Yellow 150, manufactured by BAYER Corporation, FANCHON FAST YELLOW E4GN) in place of 10 parts of the red pigment 1 of the red pigment colored composition 1.

45 [Green pigment colored composition 2]

50 **[0129]** Green pigment colored composition 2 was produced by the same method as described above using 4 parts of green pigment 2 (C. I. Pigment Green 7, manufactured by DIC Corporation, FASTOGEN GREEN S) and 6 parts of yellow pigment 3 (C. I. Pigment Yellow 138) in place of 6 parts of the green pigment 1 and 4 parts of the yellow pigment 1 of the green pigment colored composition 1.

[Blue pigment colored composition 1]

55 **[0130]** Blue pigment colored composition 1 was produced by the same method as described above using 9 parts of blue pigment 1 (C. I. Pigment Blue 15:6, manufactured by DIC Corporation, "FASTOGEN BLUE EP-210") and 1 part of violet pigment 1 (C. I. Pigment Violet 23) in place of 10 parts of the red pigment 1 of the red pigment colored composition 1.

[Blue pigment colored composition 2]

[0131] Blue pigment colored composition 2 was produced by the same method as described above using 1 part of violet pigment 1 (C. I. Basic Violet 10) in place of 1 part of the violet pigment 1 of the blue pigment colored composition 1.

[Yellow pigment colored composition 1]

[0132] Yellow pigment colored composition 1 was produced by the same method as described above using 10 parts of yellow pigment 1 (C. I. Pigment Yellow 15, manufactured by BAYER Corporation, FANCHON FAST YELLOW E4GN) in place of 10 parts of the red pigment 1 of the red pigment colored composition 1.

[Formation of color filter]

[0133] The red colored composition was applied to a thickness of 2 μm by spin coating on a glass substrate on which a black matrix had been previously formed. After drying at 70°C for 20 minutes, stripe-shaped pattern exposure was performed with ultraviolet light through a photomask using an exposure apparatus provided with a super-high pressure mercury lamp. Then, spray development with an alkali developer for 90 seconds, washing with ion exchange water, and air drying were performed. Further, post baking was performed in a clean oven at 230°C for 30 minutes to form red pixels as a stripe-shaped color layer on the transparent substrate.

[0134] Next, similarly, the green colored composition was applied to a thickness of 2 μm by spin coating. After drying, a stripe-shaped color layer was formed in a position deviated from the red pixels by exposure with an exposure apparatus and development, thereby forming green pixels adjacent to the red pixels.

[0135] Next, similarly, the blue colored composition was applied to a thickness of 2 μm by spin coating, forming blue pixels adjacent to the red pixels and the green pixels. As a result, a color filter having stripe-shaped pixels of the three colors of red, green, and blue was produced.

[0136] If required, similarly, the yellow colored composition was applied to a thickness of 2 μm by spin coating, forming yellow pixels adjacent to the red pixels and the green pixels. As a result, a color filter having stripe-shaped pixels of the four colors of red, green, blue, and yellow was produced.

[0137] Color filters 1 to 4 and comparative color filter 1 were formed by using the dye colored compositions or pigment colored compositions shown in Table 2.

[Table 2]

	Color filter 1	Color filter 2	Color filter 3	Color filter 4	Comparative Color filter 1
R pixel portion	Red dye colored composition 1	Red dye colored composition 2	Red pigment colored composition 1	Red pigment colored composition 2	Red dye colored composition 3
G pixel portion	Green dye colored composition 1	Green dye colored composition 2	Green pigment colored composition 1	Green pigment colored composition 2	Green dye colored composition 3
B pixel portion	Blue dye colored composition 1	Blue dye colored composition 2	Blue pigment colored composition 1	Blue pigment colored composition 2	Blue dye colored composition 3
Y pixel portion	No	Yellow dye colored composition 1	No	Yellow pigment colored composition 1	Yellow dye colored composition 2

[0138] Each of the pixels of the color filters was measured with respect to x value and y value in the CIE 1931 XYZ color coordinate system under a C light source using a microspectrophotometric apparatus including microscope MX-50 manufactured by Olympus Optical Co., Ltd. and spectrophotometer MCPD-3000 manufactured by Otsuka Electronics Co., Ltd. The results are shown in Table 3 below.

[Table 3]

	Color filter 1 (x, y)	Color filter 2 (x, y)	Color filter 3 (x, y)	Color filter 4 (x, y)	Comparative color filter (x, y)
5 R pixel portion	(0.63, 0.29)	(0.62, 0.31)	(0.62, 0.32)	(0.63, 0.33)	(0.59, 0.30)
G pixel portion	(0.26, 0.68)	(0.27, 0.69)	(0.24, 0.67)	(0.22, 0.65)	(0.20, 0.55)
10 B pixel portion	(0.17, 0.10)	(0.13, 0.14)	(0.14, 0.10)	(0.15, 0.07)	(0.14, 0.15)
Y pixel portion		(0.47, 0.51)		(0.48, 0.50)	(0.49, 0.48)

15 (EXAMPLES 1 to 4)

20 **[0139]** An electrode structure was formed on at least one of first and second substrates, and a horizontal alignment-type alignment film was formed on each of the facing surfaces of the substrates and weakly rubbed to form an IPS cell. Then, liquid crystal composition 1 described below was held between the first substrate and the second substrate. Table 4 shows the physical property values of the liquid crystal composition 1. Next, liquid crystal display devices of Examples 1 to 4 were formed by using the color filters 1 to 4 shown in Table 2, respectively ($d_{\text{gap}} = 4.0 \mu\text{m}$, alignment film AL-1051). VHR and ID of the resultant liquid crystal display devices were measured. Also, image sticking of the resultant liquid crystal display devices was evaluated. The results are shown in Table 5.

[Chem. 20]

	Chemical structure	Ratio	Abbreviation
5		48%	3-Cy-Cy-1d0
		4%	3-Cy-Cy-1d1
10		8%	1-Ph-Ph-3d1
		5%	3-Cy-Ph-Ph-2
15		5%	2-Ph-Ph1-Ph-3
20		2%	3-Ph-Ph3-CFFO-Ph3-F
25		3%	3-Cy-Cy-CFFO-Ph3-F
30		7%	3-Ph-Ph1-Ph3-CFFO-Ph3-F
35		5%	4-Cy-Cy-Ph3-CFFO-Ph3-F

[Table 4]

$T_{NI}/^{\circ}\text{C}$	75.8
Δn	0.112
no	1.488
ϵ_{\perp}	5.5
$\Delta\epsilon$	2.9
$\eta/\text{mPa}\cdot\text{s}$	13.5

55

[Table 5]

	Example 1	Example 2	Example 3	Example 4
Liquid crystal composition	Liquid crystal composition 1	Liquid crystal composition 1	Liquid crystal composition 1	Liquid crystal composition 1
Color filter	Color filter 1	Color filter 2	Color filter 3	Color filter 4
VHR		99.2	99.7	99.7
ID	31	52	14	16
Image sticking	A	B	A	A

[0140] It is found that the liquid crystal composition 1 has a liquid crystal layer temperature of 75.8°C in a practical range as a TV liquid crystal composition, a large absolute value of dielectric constant anisotropy, low viscosity, and optimum Δn .

[0141] The liquid crystal display devices of Examples 1 to 4 could realize high VHR and small ID. Also, in evaluation of image sticking, no residual image or slight residual image at an allowable level was observed.

(EXAMPLES 5 to 12)

[0142] As in Example 1, each of liquid crystal compositions 2 and 3 shown in Table 6 was held, and liquid crystal display devices of Examples 5 to 12 were formed by using the color filters shown in Table 2. VHR and ID of the resultant liquid crystal display devices were measured. Also, image sticking of the resultant liquid crystal display devices was evaluated. The results are shown in Tables 7 and 8.

[Table 6]

Liquid crystal composition 2			Liquid crystal composition 3	
Compound name	Content (%)		Compound name	Content (%)
4-Cy-Cy-1d0	15		5-Cy-Cy-1d0	5
0d1-Cy-Cy-Ph-1	4		3-Cy-Cy-1d1	10
0d3-Cy-Cy-Ph-1	14		0d1-Cy-Cy-Ph-1	8
3-Cy-Ph-Ph-Cy-3	3		5-Cy-Cy-Ph-01	6
3-Cy-Ph-Ph1-Cy-3	4		2-Ph-Ph1-Ph-3	8
1-Cy-Cy-Ph3-F	9		2-Cy-Cy-Ph3-F	11
2-Cy-Ph-Ph3-F	10		3-Cy-Cy-Ph3-F	15
3-Cy-Ph-Ph3-F	10		5-Cy-Cy-Ph3-F	5
5-Cy-Ph-Ph3-F	5		3-Cy-Ph-Ph3-F	6
0d1-Cy-Cy-Ph1-F	8		3-Cy-Ph-Ph1-F	9
3-Cy-Cy-Ph1-Ph3-F	8		4-Cy-Cy-Ph-OCFFF	4
2-Ph-Ph3-CFFO-Ph3-F	4		3-Cy-Cy-CFFO-Ph3-F	7
3-Ph-Ph3-CFFO-Ph3-F	6		5-Oy-Cy-CFFO-Ph3-F	4
Tni / °C	100.7		3-Cy-Cy-Ph1-Ph3-F	2
Δn	0.094		Tni / °C	1032
$\Delta \varepsilon$	8.0		Δn	0.102
γ /mPa·s	108		$\Delta \varepsilon$	7.1
η /mPa·s	22.2		γ /mPa·s	96

EP 2 916 167 A1

(continued)

	Liquid crystal composition 2			Liquid crystal composition 3	
5	Compound name	Content (%)		Compound name	Content (%)
				$\eta/mPa\cdot s$	20.8

[Table 7]

	Example 5	Example 6	Example 7	Example 8
10	Liquid crystal composition 2	Liquid crystal composition 2	Liquid crystal composition 2	Liquid crystal composition 2
15	Color filter 1	Color filter 2	Color filter 3	Color filter 4
	VHR	99.4	99.2	99.7
	ID	38	87	16
20	Image sticking	A	B	A

[Table 8]

	Example 9	Example 10	Example 11	Example 12
25	Liquid crystal composition 3	Liquid crystal composition 3	Liquid crystal composition 3	Liquid crystal composition 3
30	Color filter 1	Color filter 2	Color filter 3	Color filter 4
	VHR	99.3	99.3	99.8
	ID	49	54	13
35	Image sticking	A	A	A

[0143] The liquid crystal display devices of Examples 5 to 12 could realize high VHR and small ID. Also, in evaluation of image sticking, no residual image or slight residual image at an allowable level was observed.

(EXAMPLES 13 to 24)

[0144] As in Example 1, each of liquid crystal compositions 4 to 6 shown in Table 9 was held, and liquid crystal display devices of Examples 13 to 24 were formed by using the color filters shown in Table 2. VHR and ID of the resultant liquid crystal display devices were measured. Also, image sticking of the resultant liquid crystal display devices was evaluated. The results are shown in Tables 10 to 12.

[Table 9]

Liquid crystal composition 4		
Compound name	Content (%)	
5-Cy-Cy-1d0	15	
3-Cy-Cy-1d1	2	
0d1-Cy-Cy-Ph-1	12	
2-Ph-Ph1-Ph-3	3	
2-Ph-Ph1-Ph-4	3	
2-Cy-Cy-Ph3-F	8	
2-Cy-Ph-Ph3-F	3	
3-Cy-Ph-Ph3-F	9	
4-Cy-Cy-Ph-OCFFF	14	
3-Ph-Ph3-CFFO-Ph3-F	11	
2-Cy-Cy-CFFO-Ph3-F	9	
3-Cy-Cy-CFFO-Ph3-F	8	
3-Cy-Cy-Ph1-Ph3-F	3	
Tni / °C	90.2	
Δn	0.098	
$\Delta \varepsilon$	9.1	
γ /mPa·s	90	
η /mPa·s	18.1	
Liquid crystal composition 5		
Compound name	Content (%)	
5-Cy-Cy-1d0	10	
3-Cy-Cy-1d1	5	
0d1-Cy-Cy-Ph-1	8	
0d3-Cy-Cy-Ph-1	12	
2-Ph-Ph1-Ph-5	2	
3-Cy-Ph-Ph-Cy-3	3	
3-Cy-Ph-Ph1-Cy-3	3	
1-Cy-Cy-Ph3-F	9	
2-Cy-Cy-Ph3-F	10	
3-Cy-Cy-Ph3-F	6	
5-Cy-Cy-Ph3-F	5	
0d1-Cy-Cy-Ph1-F	8	
2-Ph-Ph3-CFFO-Ph3-F	4	
3-Ph-Ph3-CFFO-Ph3-F	6	
3-Cy-Cy-Ph1-Ph3-F	9	
Tni / °C	110.0	
Δn	0.099	
$\Delta \varepsilon$	8.3	
γ /mPa·s	112	
η /mPa·s	23.4	
Liquid crystal composition 6		
Compound name	Content (%)	
5-Cy-Cy-1d0	12	
3-Cy-Cy-1d1	25	
3-Cy-Cy-1d1	12	
0d1-Cy-Cy-Ph-1	4	
0d3-Cy-Cy-Ph-1	9	
2-Ph-Ph1-Ph3-F	5	
3-Ph-Ph1-Ph3-F	9	
2-Ph-Ph3-CFFO-Ph3-F	4	
3-Ph-Ph3-CFFO-Ph3-F	6	
3-Cy-Cy-CFFO-Ph3-F	2	
5-Cy-Cy-CFFO-Ph3-F	3	
3-Cy-Cy-Ph1-Ph3-F	9	
Tni / °C	774	
Δn	0.101	
$\Delta \varepsilon$	7.0	
γ /mPa·s	86	
η /mPa·s	142	

[Table 10]

	Example 13	Example 14	Example 15	Example 16
Liquid crystal composition	Liquid crystal composition 4	Liquid crystal composition 4	Liquid crystal composition 4	Liquid crystal composition 4
Color filter	Color filter 1	Color filter 2	Color filter 3	Color filter 4
VHR	99.3	99.4	99.8	99.6
ID	55	46	12	15
Image sticking	A	A	A	A

[Table 11]

	Example 17	Example 18	Example 19	Example 20
Liquid crystal composition	Liquid crystal composition 5	Liquid crystal composition 5	Liquid crystal composition 5	Liquid crystal composition 5
Color filter	Color filter 1	Color filter 2	Color filter 3	Color filter 4
VHR	99.4	99.3	99.6	99.6
ID	56	72	17	15
Image sticking	A	B	A	A

[Table 12]

	Example 21	Example 22	Example 23	Example 24
Liquid crystal composition	Liquid crystal composition 6	Liquid crystal composition 6	Liquid crystal composition 6	Liquid crystal composition 6
Color filter	Color filter 1	Color filter 2	Color filter 3	Color filter 4
VHR	99.3	99.5	99.6	99.7
ID	74	42	17	14
Image sticking	B	A	A	A

[0145] The liquid crystal display devices of Examples 13 to 24 could realize high VHR and small ID. Also, in evaluation of image sticking, no residual image or slight residual image at an allowable level was observed.

(EXAMPLES 25 to 36)

[0146] An electrode structure was formed on each of first and second substrates, and a horizontal alignment-type alignment film was formed on each of the facing surfaces of the substrates and weakly rubbed to form a TN cell. Then, each of liquid crystal compositions 7 to 9 shown in Table 13 was held between the first substrate and the second substrate. Next, liquid crystal display devices of Examples 25 to 36 were formed by using the color filters 1 to 4 shown in Table 2 ($d_{\text{gap}} = 3.5 \mu\text{m}$, alignment film SE-7492). VHR and ID of the resultant liquid crystal display devices were measured. Also, image sticking of the resultant liquid crystal display devices was evaluated. The results are shown in Tables 14 to 16.

[Table 13]

Liquid crystal competition 7			Liquid crystal competition 8			Liquid crystal competition 9		
Compound name	Content (%)		Compound name	Content (%)		Compound name	Content (%)	
3-Cy-Cy-1d0	38		3-Cy-Cy-1d0	38		3-Cy-Gy-1d0	30	
3-Cy-Cy-1d1	9		3-Cy-Cy-1d1	14		3-Cy-Cy-1d1	17	
0d1-Cy-Cy-Ph-1	16		0d3-Cy-Cy-Ph-1	8		0d1-Cy-Cy-Ph-1	17	
0d3-Cy-Cy-Ph-1	4		3-Ph-Ph3-CFFO-Ph3-F	9		0d3-Cy-Cy-Ph-1	7	
2-Ph-Ph3-CFFO-Ph3-F	2		3-Cy-Cy-CFFO-Ph3-F	15		3-Cy-Cy-Ph-2	2	
3-Ph-Ph3-CFFO-Ph3-F	12		3-Ph-Ph1-Ph3-CFFO-Ph3-F	2		2-Ph-Ph1-Ph-4	2	
3-Cy-Cy-CFFO-Ph3-F	7		4-Ph-Ph1-Ph3-CFFO-Ph3-F	7		2-Ph-Ph1-Ph3-F	8	
3-Ph-Ph-Ph1-Ph3-F	1		5-Ph-Ph1-Ph3-CFFO-Ph3-F	7		3-Ph-Ph1-Ph3-F	12	
3-Ph-Ph1-Ph3-CFFO-Ph3-F	2					3-Ph-Ph3-Ph3-F	4	
2-Py-Ph-Ph3-CFFO-Ph3-F	9					3-Cy-Cy-Ph1-CFFO-Ph3-F	11	
Tni / °C	76.0		Tni / °C	81.8		Tni / °C	75.0	
Δn	0.097		Δn	0.099		Δn	0.112	
$\Delta \epsilon$	6.8		$\Delta \epsilon$	8.0		$\Delta \epsilon$	8.7	
γ /mPa·s	83		γ /mPa·s	83		γ /mPa·s	87	
η /mPa·s	14.5		η /mPa·s	14.6		η /mPa·s	15.2	

[Table 14]

	Example 25	Example 26	Example 27	Example 28
Liquid crystal composition	Liquid crystal composition 7	Liquid crystal composition 7	Liquid crystal composition 7	Liquid crystal composition 7
Color filter	Color filter 1	Color filter 2	Color filter 3	Color filter 4
VHR	99.2		99.5	99.6
ID	80	43	22	14
Image sticking	B	A	A	A

[Table 15]

	Example 29	Example 30	Example 31	Example 32
Liquid crystal composition	Liquid crystal composition 8	Liquid crystal composition 8	Liquid crystal composition 8	Liquid crystal composition 8
Color filter	Color filter 1	Color filter 2	Color filter 3	Color filter 4
VHR	99.1	99.3	99.7	99.6
ID	89	67	11	16
Image sticking	B	A	A	A

[Table 16]

	Example 33	Example 34	Example 35	Example 36
Liquid crystal composition	Liquid crystal composition 9	Liquid crystal composition 9	Liquid crystal composition 9	Liquid crystal composition 9
Color filter	Color filter 1	Color filter 2	Color filter 3	Color filter 4
VHR	99.2	99.5	99.8	99.7
ID	72	36	12	17
Image sticking	A	A	A	A

[0147] The liquid crystal display devices of Examples 25 to 36 could realize high VHR and small ID. Also, in evaluation of image sticking, no residual image or slight residual image at an allowable level was observed.

(EXAMPLES 37 to 44)

[0148] An electrode structure was formed on at least one of first and second substrates, and a horizontal alignment-type alignment film was formed on each of the facing surfaces of the substrates and weakly rubbed to form a FFS cell. Then, each of liquid crystal compositions 10 and 11 shown in Table 17 was held between the first substrate and the second substrate. Next, liquid crystal display devices of Examples 37 to 44 were formed by using the color filters 1 to 4 shown in Table 2 ($d_{\text{gap}} = 4.0 \mu\text{m}$, alignment film AL-1051). VHR and ID of the resultant liquid crystal display devices were measured. Also, image sticking of the resultant liquid crystal display devices was evaluated. The results are shown in Tables 18 and 19.

[Table 17]

Liquid crystal composition 10		Liquid crystal composition 11	
Compound name	Content (%)	Compound name	Content (%)
3-Cy-Cy-1d0	39	3-Cy-Cy-1d0	44
3-Cy-Cy-1d1	7	3-Cy-Cy-1d1	3
0d1-Cy-Cy-Ph-1	11	2-Ph-Ph-3d1	13
2-Ph-Ph1-Ph-3	8	3-Cy-Ph-Ph-2	7
2-Ph-Ph1-Ph-5	8	2-Ph-Ph1-Ph-3	8
3-Ph-Ph3-CFFO-Ph3-F	10	3-Ph-Ph1-Ph-3	7
3-Cy-Cy-Ph-Ph3-F	6	3-Ph-Ph1-Ph3-CFFO-Ph3-F	9
4-Ph-Ph1-Ph3-CFFO-Ph3-F	11	4-Cy-Cy-Ph1-CFFO-Ph3-F	3
T _{ni} /°C	76.0	3-Cy-Ph3-Ph1-OCFFF	6
Δn	0.114	T _{ni} /°C	77.9
$\Delta \epsilon$	6.0	Δn	0.131
γ /mPa·s	77	$\Delta \epsilon$	4.6
η /mPa·s	13.3	γ /mPa·s	74
		η /mPa·s	12.4

[Table 18]

	Example 37	Example 38	Example 39	Example 40
Liquid crystal composition	Liquid crystal composition 10	Liquid crystal composition 10	Liquid crystal composition 10	Liquid crystal composition 10
Color filter	Color filter 1	Color filter 2	Color filter 3	Color filter 4
VHR	99.2	99.3	99.5	99.6
ID	79	52	26	18
Image sticking	B	A	A	A

[Table 19]

	Example 41	Example 42	Example 43	Example 44
Liquid crystal composition	Liquid crystal composition 11	Liquid crystal composition 11	Liquid crystal composition 11	Liquid crystal composition 11
Color filter	Color filter 1	Color filter 2	Color filter 3	Color filter 4
VHR	99.3	99.4	99.7	99.6
ID	68	57	12	18
Image sticking	A	A	A	A

[0149] The liquid crystal display devices of Examples 37 to 44 could realize high VHR and small ID. Also, in evaluation of image sticking, no residual image or slight residual image at an allowable level was observed.

(EXAMPLES 45 to 56)

[0150] AS in Example 37, each of liquid crystal compositions 12 to 14 shown in Table 20 was held, and liquid crystal display devices of Examples 45 to 56 were formed by using the color filters shown in Table 2. VHR and ID of the resultant liquid crystal display devices were measured. Also, image sticking of the resultant liquid crystal display devices was evaluated. The results are shown in Tables 21 to 23.

EP 2 916 167 A1

[Table 21]

	Example 45	Example 46	Example 47	Example 48
Liquid crystal composition	Liquid crystal composition 12	Liquid crystal composition 12	Liquid crystal composition 12	Liquid crystal composition 12
Color filter	Color filter 1	Color filter 2	Color filter 3	Color filter 4
VHR	99.3	99.3	99.8	99.6
ID	64	56	11	21
Image sticking	A	A	A	A

[Table 22]

	Example 49	Example 50	Example 51	Example 52
Liquid crystal composition	Liquid crystal composition 13	Liquid crystal composition 13	Liquid crystal composition 13	Liquid crystal composition 13
Color filter	Color filter 1	Color filter 2	Color filter 3	Color filter 4
VHR	99.2	99.3	99.5	99.6
ID	75	58	27	20
Image sticking	B	A	A	A

[Table 23]

	Example 53	Example 54	Example 55	Example 56
Liquid crystal composition	Liquid crystal composition 14	Liquid crystal composition 14	Liquid crystal composition 14	Liquid crystal composition 14
Color filter	Color filter 1	Color filter 2	Color filter 3	Color filter 4
VHR	99.4	99.1	99.8	99.7
ID	64	82	14	19
Image sticking	A	B	A	A

[0151] The liquid crystal display devices of Examples 45 to 56 could realize high VHR and small ID. Also, in evaluation of image sticking, no residual image or slight residual image at an allowable level was observed.

(EXAMPLES 57 to 60)

[0152] A liquid crystal composition 15 was prepared by mixing 0.3% by mass of biphenyl-4,4'-diyl bismethacrylate with the liquid crystal composition 10 used in Example 37. The liquid crystal composition 15 was interposed in a TN cell and then polymerized by ultraviolet irradiation (3.0 J/cm²) for 600 seconds while a driving voltage was applied between electrodes. Next, liquid crystal display devices of Examples 57 to 60 were formed by using the color filters 1 to 4 shown in Table 2, and VHR and ID of the resultant liquid crystal display devices were measured. Also, image sticking of the resultant liquid crystal display devices was evaluated. The results are shown in Table 24.

[Table 24]

	Example 57	Example 58	Example 59	Example 60
Liquid crystal composition	Liquid crystal composition 15	Liquid crystal composition 15	Liquid crystal composition 15	Liquid crystal composition 15
Color filter	Color filter 1	Color filter 2	Color filter 3	Color filter 4

EP 2 916 167 A1

(continued)

	Example 57	Example 58	Example 59	Example 60
VHR	99.4	99.4	99.6	99.6
ID	65	58	16	17
Image sticking	B	A	A	A

[0153] The liquid crystal display devices of Examples 57 to 60 could realize high VHR and small ID. Also, in evaluation of image sticking, no residual image or slight residual image at an allowable level was observed.

(EXAMPLES 61 to 64)

[0154] A liquid crystal composition 16 was prepared by mixing 0.3% by mass of biphenyl-4,4'-diyl bismethacrylate with the liquid crystal composition 8 used in Example 29. The liquid crystal composition 16 was interposed in an IPS cell and then polymerized by ultraviolet irradiation (3.0 J/cm²) for 600 seconds while a driving voltage was applied between electrodes. Next, liquid crystal display devices of Examples 61 to 64 were formed by using the color filters 1 to 4 shown in Table 2, and VHR and ID of the resultant liquid crystal display devices were measured. Also, image sticking of the resultant liquid crystal display devices was evaluated. The results are shown in Table 25.

[Table 25]

	Example 61	Example 62	Example 63	Example 64
Liquid crystal composition	Liquid crystal composition 16	Liquid crystal composition 16	Liquid crystal composition 16	Liquid crystal composition 16
Color filter	Color filter 1	Color filter 2	Color filter 3	Color filter 4
VHR	99.0	99.2	99.6	99.6
ID	92	65	14	17
Image sticking	B	B	A	A

[0155] The liquid crystal display devices of Examples 61 to 64 could realize high VHR and small ID. Also, in evaluation of image sticking, no residual image or slight residual image at an allowable level was observed.

(EXAMPLES 65 to 68)

[0156] A liquid crystal composition 17 was prepared by mixing 0.3% by mass of 3-fluorobiphenyl-4,4'-diyl bismethacrylate with the liquid crystal composition 6 used in Example 21. The liquid crystal composition 17 was interposed in a FFS cell and then polymerized by ultraviolet irradiation (3.0 J/cm²) for 600 seconds while a driving voltage was applied between electrodes. Next, liquid crystal display devices of Examples 65 to 68 were formed by using the color filters 1 to 4 shown in Table 2, and VHR and ID of the resultant liquid crystal display devices were measured. Also, image sticking of the resultant liquid crystal display devices was evaluated. The results are shown in Table 26.

[Table 26]

	Example 65	Example 66	Example 67	Example 68
Liquid crystal composition	Liquid crystal composition 17	Liquid crystal composition 17	Liquid crystal composition 17	Liquid crystal composition 17
Color filter	Color filter 1	Color filter 2	Color filter 3	Color filter 4
VHR	99.3	99.4	99.6	99.6
ID	78	49	19	18
Image sticking	B	A	A	A

[0157] The liquid crystal display devices of Examples 65 to 68 could realize high VHR and small ID. Also, in evaluation

of image sticking, no residual image or slight residual image at an allowable level was observed.

(COMPARATIVE EXAMPLES 1 to 4)

5 **[0158]** A comparative liquid crystal composition 1 described below was interposed in the IPS cell used in Example 1.
[0159] Table 27 shows the physical property values of the comparative liquid crystal composition. Next, liquid crystal display devices of Comparative Examples 1 to 4 were formed by using the color filters 1 to 4 shown in Table 2, and VHR and ID of the resultant liquid crystal display devices were measured. Also, image sticking of the resultant liquid crystal display devices was evaluated. The results are shown in Table 28.

[Chem. 21]

15	Chemical structure	Ratio	Abbreviation
		27%	4-Cy-VO-Ph-1
20		20%	5-Cy-VO-Ph-1
		20%	5-Cy-VO-Ph-3
25			
		8%	3-Ph-Ph3-CFFO-Ph3-F
30			
		13%	3-Cy-Cy-CFFO-Ph3-F
35			
		12%	3-Ph-Ph1-Ph3-CFFO-Ph3-F
40			

[Table 27]

45	$T_{NI}/^{\circ}\text{C}$	69.3
	Δn	0.096
	no	1.484
	ϵ_{\perp}	5.5
50	$\Delta\epsilon$	4.8
	$\eta/\text{mPa}\cdot\text{s}$	30.3

55

[Table 28]

	Comparative Example 1	Comparative Example 2	Comparative Example 3	Comparative Example 4
Liquid crystal composition	Comparative liquid crystal composition 1	Comparative liquid crystal composition 1	Comparative liquid crystal composition 1	Comparative liquid crystal composition 1
Color filter	Color filter 1	Color filter 2	Color filter 3	Color filter 4
VHR	98.2	98.1	98.5	98.4
ID	142	157	132	147
Image sticking	D	D	D	D

[0160] The liquid crystal display devices of Comparative Examples 1 to 4 showed lower VHR and larger ID than the liquid crystal display devices of the present invention. Also, in evaluation of image sticking, the occurrence of residual image at an unallowable level was observed.

(COMPARATIVE EXAMPLES 5 to 12)

[0161] As in Example 1, each of comparative liquid crystal compositions 2 and 3 shown in Table 29 was interposed, and liquid crystal display devices of Comparative Examples 5 to 12 were formed by using the color filters 1 to 4 shown in Table 2, and VHR and ID of the resultant liquid crystal display devices were measured. Also, image sticking of the resultant liquid crystal display devices was evaluated. The results are shown in Tables 30 and 31.

[Table 29]

Comparative liquid crystal composition 2		Comparative liquid crystal composition 3	
Compound name	Content (%)	Compound name	Content (%)
2-Cy-Cy-Ph3-F	12	2-Cy-Cy-Ph3-F	12
3-Cy-Cy-Ph3-F	10	3-Cy-Cy-Ph3-F10	10
5-Cy-Cy-Ph3-F	6	2-Cy-Cy-Ph-OCFFF8	8
2-Cy-Cy-Ph-OCFFF	9	3-Cy-Cy-Ph-OCFFF8	8
3-Cy-Cy-Ph-OCFFF	8	4-Cy-Cy-Ph-OCFFF	7
4-Cy-Cy-Ph-OCFFF	7	5-Cy-Cy-Ph-OCFFF	4
2-Cy-Ph1-Ph3-F	12	2-Cy-Ph1-Ph3-F	12
3-Cy-Ph1-Ph3-F	10	3-Cy-Ph1-Ph3-F	4
2-Cy-Py-Cy-CFFO-Ph3-F	5.5	2-Cy-Cy-CFFO-Ph3-F	12
2-Ph-Ph1-Ph3-F	5.5	2-Ph-Ph1-Ph3-F	8
0d1-Cy-Cy-CFFO-Ph3-F	15	0d1-Cy-Cy-CFFO-Ph3-F	15
$T_{ni}/^{\circ}\text{C}$	75.7	$T_{ni}/^{\circ}\text{C}$	75.0
Δn	0.093	Δn	0.093
$\gamma_1/\text{mPa}\cdot\text{s}$	146	$\gamma_1/\text{mPa}\cdot\text{s}$	139

[Table 30]

	Comparative Example 5	Comparative Example 6	Comparative Example 7	Comparative Example 8
Liquid crystal composition	Comparative liquid crystal composition 2	Comparative liquid crystal composition 2	Comparative liquid crystal composition 2	Comparative liquid crystal composition 2
Color filter	Color filter 1	Color filter 2	Color filter 3	Color filter 4

EP 2 916 167 A1

(continued)

	Comparative Example 5	Comparative Example 6	Comparative Example 7	Comparative Example 8
5	VHR	98.1	98.2	98.3
	ID	150	149	124
10	Image sticking	D	D	C

[Table 31]

	Comparative Example 9	Comparative Example 10	Comparative Example 11	Comparative Example 12
15	Liquid crystal composition	Comparative liquid crystal composition 3	Comparative liquid crystal composition 3	Comparative liquid crystal composition 3
20	Color filter	Color filter 1	Color filter 2	Color filter 3
	VHR	98.3	98.2	98.5
	ID	160	168	118
25	Image sticking	D	D	C

[0162] The liquid crystal display devices of Comparative Examples 5 to 12 showed lower VHR and larger ID than the liquid crystal display devices of the present invention. Also, in evaluation of image sticking, the occurrence of residual image at an unallowable level was observed.

(COMPARATIVE EXAMPLES 13 to 20)

[0163] As in Example 1, each of comparative liquid crystal compositions 4 and 5 shown in Table 32 was interposed, and liquid crystal display devices of Comparative Examples 13 to 24 were formed by using the color filters 1 to 4 shown in Table 2, and VHR and ID of the resultant liquid crystal display devices were measured. Also, image sticking of the resultant liquid crystal display devices was evaluated. The results are shown in Tables 33 and 34.

[Table 32]

Comparative liquid crystal composition 4		Comparative liquid crystal composition 5	
Compound name	Content (%)	Compound name	Content (%)
4-Cy-Cy-1d0	15	2-Cy-Cy-1-d0	32
0d1-Cy-Cy-Ph-1	4	0d1-Cy-Cy-Ph-1	4
0d3Cy-Cy-Ph-1	14	2-Ph-Ph1-Ph-3	10
3-Cy-Ph-Ph-Cy-3	3	2-Ph-Ph1-Ph-5	11
3-Cy-Ph-Ph1-Cy-3	34	3-Ph-Ph1-Ph-5	7
1-Cy-Cy-Ph3-F	9	2-Cy-Cy-Ph-F	6
2-Cy-Cy-Ph3-F	10	3-Cy-Cy-Ph-F	21
3-Cy-Cy-Ph3-F	10	5-Cy-Ph-Ph-F	7
5-Cy-Cy-Ph3-F	5	3-Cy-Ph-Ph3-F	2
3-Cy-Ph1-Ph3-F	8	Tni/°C	772
5-Cy-Ph1-Ph3-F	7	Δn	0.135
3-Ph-Ph1-Ph3-F	3	$\Delta \epsilon$	4.5
3-Cy-Cy-Ph1-Ph3-F	8	γ /mPa·s	57
Tni/°C	101.0	η /mPa·s	10.5

EP 2 916 167 A1

(continued)

Comparative liquid crystal composition 4		Comparative liquid crystal composition 5	
Compound name	Content (%)	Compound name	Content (%)
Δn	0.095		
$\Delta \epsilon$	8.2		
$\gamma / \text{mPa}\cdot\text{s}$	115		
$\eta / \text{mPa}\cdot\text{s}$	23.6		

[Table 33]

	Comparative Example 13	Comparative Example 14	Comparative Example 15	Comparative Example 16
Liquid crystal composition	Comparative liquid crystal composition 4	Comparative liquid crystal composition 4	Comparative liquid crystal composition 4	Comparative liquid crystal composition 4
Color filter	Color filter 1	Color filter 2	Color filter 3	Color filter 4
VHR	98.0	98.2	98.3	98.3
ID	178	142	148	146
Image sticking	D	D	D	D

[Table 34]

	Comparative Example 17	Comparative Example 18	Comparative Example 19	Comparative Example 20
Liquid crystal composition	Comparative liquid crystal composition 5	Comparative liquid crystal composition 5	Comparative liquid crystal composition 5	Comparative liquid crystal composition 5
Color filter	Color filter 1	Color filter 2	Color filter 3	Color filter 4
VHR	98.1	98.2	98.2	98.3
ID	180	153	131	137
Image sticking	D	D	C	D

[0164] The liquid crystal display devices of Comparative Examples 13 to 20 showed lower VHR and larger ID than the liquid crystal display devices of the present invention. Also, in evaluation of image sticking, the occurrence of residual image at an unallowable level was observed.

(COMPARATIVE EXAMPLES 21 to 32)

[0165] As in Example 1, each of comparative liquid crystal compositions 6 to 8 shown in Table 35 was interposed, and liquid crystal display devices of Comparative Examples 21 to 32 were formed by using the color filters 1 to 4 shown in Table 2, and VHR and ID of the resultant liquid crystal display devices were measured. Also, image sticking of the resultant liquid crystal display devices was evaluated. The results are shown in Tables 36 to 38.

EP 2 916 167 A1

[Table 35]

Comparative liquid crystal composition 6		Comparative liquid crystal composition 7		Comparative liquid crystal composition 8	
Compound name	Content (%)	Compound name	Content (%)	Compound name	Content (%)
4-Cy-Cy-1d0	18	4-Cy-Cy-1d0	18	4-Cy-Cy-1d0	17
3-Cy-Cy-4	15	3-Cy-Cy-4	15	3-Cy-Cy-4	15
0d1-Cy-Cy-Ph-1	8	0d1-Cy-Cy-Ph-1	8	0d3-Cy-Cy-Ph-1	8
2-Ph-Ph1-Ph-3	10	2-Ph-Ph1-Ph-3	10	3-Cy-Ph-Ph-2	10
2-Ph-Ph1-Ph-5	6	2-Ph-Ph1-Ph-5	6	2-Ph-Ph1-Ph-5	7
3-Ph-Ph1-Ph-5	6	3-Ph-Ph1-Ph-5	5	3-Ph-Ph1-Ph-5	7
2-Cy-Cy-Ph-F	6	2-Cy-Cy-Ph-F	6	2-Cy-Cy-Ph-F	6
3-Cy-Cy-Ph-F	10	3-Cy-Cy-Ph-F	5	3-Cy-Cy-Ph-F	5
5-Cy-Ph-Ph-F	7	5-Cy-Ph-Ph-F	7	5-Cy-Ph-Ph-F	7
3-Cy-Ph-Ph3-F	14	3-Cy-Ph-Ph3-F	15	3-Cy-Ph-Ph3-F	14
Tni / °C	73.5	3-Cy-Cy-Ph1-Ph3-F	5	3-Cy-Cy-Ph1-Ph3-F	4
Δn	0.126	Tni / °C	75.7	Tni / °C	85.3
$\Delta \varepsilon$	4.9	Δn	0.125	Δn	0.128
γ_1 / mPa·s	94	$\Delta \varepsilon$	5.5	$\Delta \varepsilon$	4.8
η /mpa·s	16.9	γ_1 / mPa·s	103	γ_1 / mPa·s	107
		η /mPa·s	18.4	η /mPa·s	19.0

[Table 36]

	Comparative Example 21	Comparative Example 22	Comparative Example 23	Comparative Example 24
Liquid crystal composition	Comparative liquid crystal composition 6	Comparative liquid crystal composition 6	Comparative liquid crystal composition 6	Comparative liquid crystal composition 6
Color filter	Color filter 1	Color filter 2	Color filter 3	Color filter 4
VHR	98.0	98.1	98.3	98.3
ID	182	174	140	146
Image sticking	D	D	D	D

[Table 37]

	Comparative Example 25	Comparative Example 26	Comparative Example 27	Comparative Example 28
Liquid crystal composition	Comparative liquid crystal composition 7	Comparative liquid crystal composition 7	Comparative liquid crystal composition 7	Comparative liquid crystal composition 7
Color filter	Color filter 1	Color filter 2	Color filter 3	Color filter 4
VHR	98.1	98.3	98.5	98.4

EP 2 916 167 A1

(continued)

	Comparative Example 25	Comparative Example 26	Comparative Example 27	Comparative Example 28
5	Liquid crystal composition	Comparative liquid crystal composition 7	Comparative liquid crystal composition 7	Comparative liquid crystal composition 7
	ID	169	147	118
10	Image sticking	D	D	C
				125
				D

[Table 38]

	Comparative Example 29	Comparative Example 30	Comparative Example 31	Comparative Example 32
15	Liquid crystal composition	Comparative liquid crystal composition 8	Comparative liquid crystal composition 8	Comparative liquid crystal composition 8
20	Color filter	Color filter 1	Color filter 2	Color filter 3
	VHR	98.1	98.0	98.3
25	ID	162	184	136
	Image sticking	D	D	D
				122

30 **[0166]** The liquid crystal display devices of Comparative Examples 21 to 32 showed lower VHR and larger ID than the liquid crystal display devices of the present invention. Also, in evaluation of image sticking, the occurrence of residual image at an unallowable level was observed.

(COMPARATIVE EXAMPLES 33 to 44)

35 **[0167]** As in Example 1, each of comparative liquid crystal compositions 9 to 11 shown in Table 39 was interposed, and liquid crystal display devices of Comparative Examples 33 to 44 were formed by using the color filters 1 to 4 shown in Table 2, and VHR and ID of the resultant liquid crystal display devices were measured. Also, image sticking of the resultant liquid crystal display devices was evaluated. The results are shown in Tables 40 to 42.

40

45

50

55

[Table 40]

	Comparative Example 33	Comparative Example 34	Comparative Example 35	Comparative Example 36
Liquid crystal composition	Comparative liquid crystal composition 9	Comparative liquid crystal composition 9	Comparative liquid crystal composition 9	Comparative liquid crystal composition 9
Color filter	Color filter 1	Color filter 2	Color filter 3	Color filter 4
VHR	98.1	98.2	98.6	98.5
ID	153	144	126	130
Image sticking	D	D	D	D

[Table 41]

	Comparative Example 37	Comparative Example 38	Comparative Example 39	Comparative Example 40
Liquid crystal composition	Comparative liquid crystal composition 10	Comparative liquid crystal composition 10	Comparative liquid crystal composition 10	Comparative liquid crystal composition 10
Color filter	Color filter 1	Color filter 2	Color filter 3	Color filter 4
VHR	98.1	98.3	98.5	98.4
ID	157	133	131	128
Image sticking	D	D	c	D

[Table 42]

	Comparative Example 41	Comparative Example 42	Comparative Example 43	Comparative Example 44
Liquid crystal composition	Comparative liquid crystal composition 11	Comparative liquid crystal composition 11	Comparative liquid crystal composition 11	Comparative liquid crystal composition 11
Color filter	Color filter 1	Color filter 2.	Color filter 3	Color filter 4
VHR	98.1	98.2	98.4	98.3
ID	162	148	119	136
Image sticking	D	D	D	D

[0168] The liquid crystal display devices of Comparative Examples 33 to 44 showed lower VHR and larger ID than the liquid crystal display devices of the present invention. Also, in evaluation of image sticking, the occurrence of residual image at an unallowable level was observed.

(COMPARATIVE EXAMPLES 45 to 52)

[0169] Liquid crystal display devices of Comparative Examples 45 to 52 were formed by the same method as in Examples 5, 13, 17, 25, 37, 45, 61, and 65 except that the comparative color filter 1 shown in Table 2 was used in place of the color filter 1, and VHR and ID of the resultant liquid crystal display devices were measured. Also, image sticking

of the resultant liquid crystal display devices was evaluated. The results are shown in Tables 43 and 44.

[Table 43]

	Comparative Example 45	Comparative Example 46	Comparative Example 47	Comparative Example 48
Liquid crystal composition	Liquid crystal composition 2	Liquid crystal composition 4	Liquid crystal composition 5	Liquid crystal composition 7
Color filter	Comparative Color filter 1	Comparative Color filter 1	Comparative Color filter 1	Comparative Color filter 1
VHR	97.8	98.0	98.2	98.3
ID	210	196	176	166
Image sticking	D	D	D	D

[Table 44]

	Comparative Example 49	Comparative Example 50	Comparative Example 51	Comparative Example 52
Liquid crystal composition	Liquid crystal composition 10	Liquid crystal composition 12	Liquid crystal composition 16	Liquid crystal composition 17
Color filter	Comparative Color filter 1	Comparative Color filter 1	Comparative Color filter 1	Comparative Color filter 1
VHR	97.9	98.1	98.3	98.3
ID	204	184	169	170
Image sticking	D	D	D	D

[0170] The liquid crystal display devices of Comparative Examples 45 to 52 showed lower VHR and larger ID than the liquid crystal display devices of the present invention. Also, in evaluation of image sticking, the occurrence of residual image at an unallowable level was observed.

Claims

1. A liquid crystal display device comprising a first substrate, a second substrate, a liquid crystal composition layer held between the first substrate and the second substrate, a color filter including a black matrix and at least RGB three-color pixel portions, a pixel electrode, and a common electrode, wherein the liquid crystal composition layer includes a liquid crystal composition which contains at least one compound represented by general formula (I),

[Chem. 1]

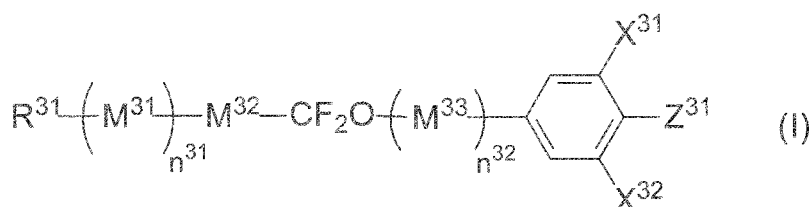

(in the formula, R³¹ represents an alkyl group having 1 to 10 carbon atoms, an alkoxy group, or an alkenyl group or alkenyloxy group having 2 to 10 carbon atoms, M³¹ to M³³ each independently represent a trans-1,4-cyclohexylene group or a 1,4-phenylene group, one or two -CH₂- in the trans-1,4-cyclohexylene group may be substituted by -O-

so that oxygen atoms are not directly adjacent to each other, one or two hydrogen atoms in the phenylene group may be substituted by fluorine atoms, X^{31} and X^{32} each independently represent a hydrogen atom or a fluorine atom, Z^{31} represents a fluorine atom, a trifluoromethoxy group, or a trifluoromethyl group, n^{31} and n^{32} each independently represent 0, 1, or 2, $n^{31} + n^{32}$ represents 0, 1, or 2, and when a plurality of each of M^{31} and M^{33} are present, each may be the same or different), and at least one compound selected from the group consisting of compounds represented by general formula (II-a) to general formula (II-e),

[Chem. 2]

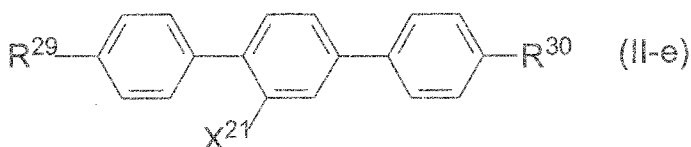
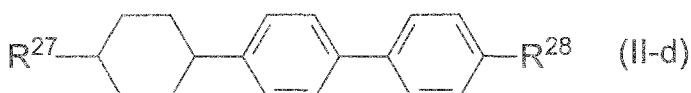
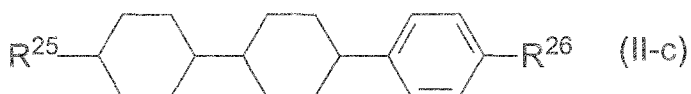
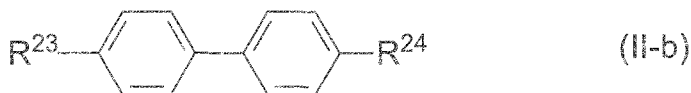
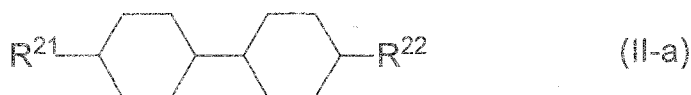

(in the formulae, R^{21} to R^{30} each independently represent an alkyl group having 1 to 10 carbon atoms or an alkenyl group having 2 to 10 carbon atoms, and X^{21} represents a hydrogen atom or a fluorine atom), and the RGB three-color pixel portions include, as colorants, a diketopyrrolopyrrole pigment and/or anionic red organic dye in a R pixel portion, at least one selected from the group consisting of a halogenated copper phthalocyanine pigment, a phthalocyanine green dye, and a mixture of a phthalocyanine blue dye and an azo yellow organic dye in a G pixel portion, and a ϵ -type copper phthalocyanine pigment and/or cationic blue organic dye in a B pixel portion.

- 35
2. The liquid crystal display device according to Claims 1, wherein the RGB three-color pixel portions include, as colorants, C. I. Solvent Red 124 in the R pixel portion, a mixture of C. I. Solvent Blue 67 and C. I. Solvent Yellow 162 in the G pixel portion, and C. I. Solvent Blue 7 in the B pixel portion.
 - 40 3. The liquid crystal display device according to Claim 1, wherein the RGB three-color pixel portions include, as colorants, C. I. pigment Red 254 in the R pixel portion, C. I. Pigment Green 7 and/or 36 in the G pixel portion, and C. I. Pigment Blue 15:6 in the B pixel portion.
 - 45 4. The liquid crystal display device according to any one of Claims 1 to 3, wherein the R pixel portion further contains at least one organic dye/pigment selected from the group consisting of C. I. Pigment Red 177, 242, 166, 167, and 179, C. I. Pigment Orange 38 and 71, C. I. Pigment Yellow 150, 215, 185, 138, and 139, C. I. Solvent Red 89, C. I. Solvent Orange 56, and C. I. Solvent Yellow 21, 82, 83:1, 33, and 162.
 - 50 5. The liquid crystal display device according to any one of Claims 1 to 4, wherein the G pixel portion further contains at least one organic dye/pigment selected from the group consisting of C. I. Pigment Yellow 150, 215, 185, and 138, and C. I. Solvent Yellow 21, 82, 83:1, and 33.
 - 55 6. The liquid crystal display device according to any one of Claims 1 to 5, wherein the B pixel portion further contains at least one organic dye/pigment selected from the group consisting of C. I. Pigment Blue 1, C. I. Pigment Violet 23, C. I. Basic Blue 7, C. I. Basic Violet 10, C. I. Acid Blue 1, 90, and 83, and C. I. Direct Blue 86.
 7. The liquid crystal display device according to any one of Claims 1 to 6, wherein the color filter includes a black matrix, RGB three-color pixel portions, and a Y pixels portion, and contains, as a colorant in the Y pixel portion, at

least one yellow organic dye/pigment selected from the group consisting of C. I. Pigment Yellow 150, 215, 185, 138, and 139, and C. I. Solvent Yellow 21, 82, 83:1, 33, and 162.

8. The Liquid crystal display device according to any one of Claims 1 to 7, wherein compounds represented by the general formula (I) are compounds represented by general formula (I-a) to general formula (I-f),

[Chem. 3]

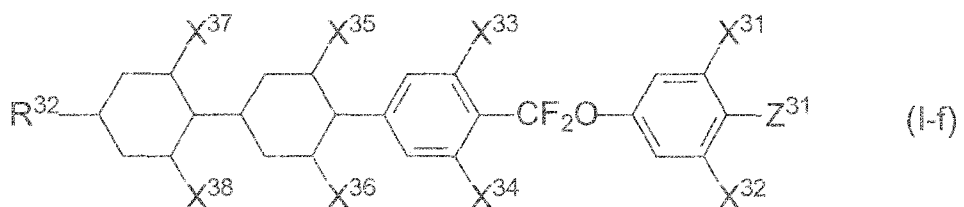
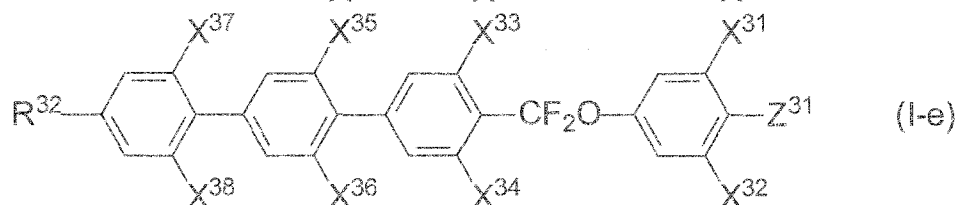
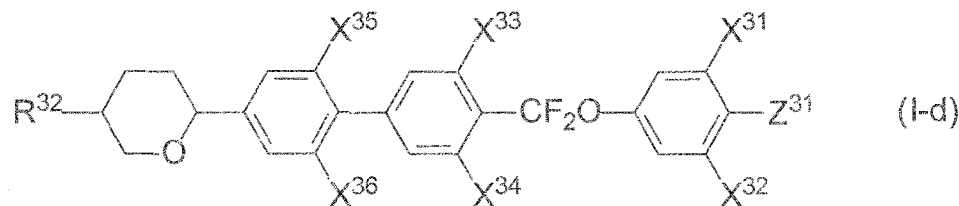
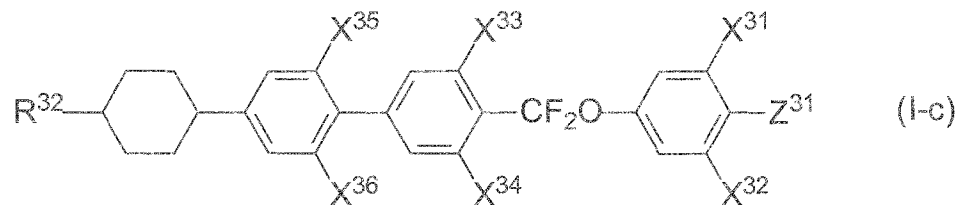
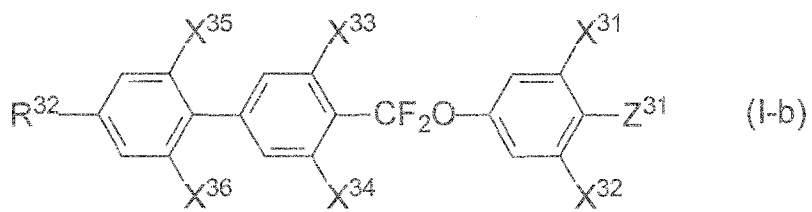
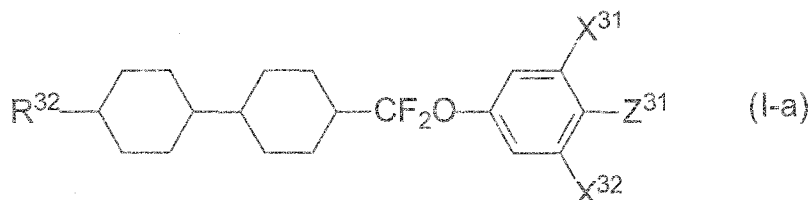

40

(in the formulae, R³¹ represents an alkyl group having 1 to 10 carbon atoms, an alkoxy group, or an alkenyl group or alkenyloxy group having 2 to 10 carbon atoms, X³¹ to X³⁸ each independently represent a hydrogen atom or a fluorine atom, and Z³¹ represents a fluorine atom, a trifluoromethoxy group, or a trifluoromethyl group).

- 45
9. The liquid crystal display device according to any one of Claims 1 to 8, wherein the Liquid crystal composition layer further contains at least one compound selected from the compound group represented by general formula (III-a) to general formula (III-f),

[Chem. 4]

5

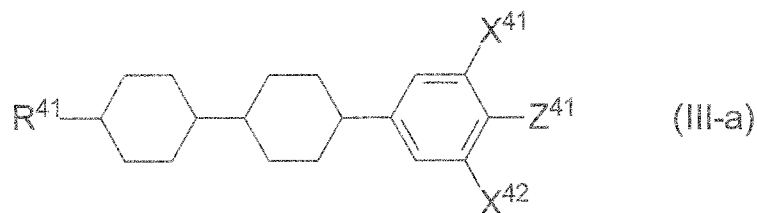

10

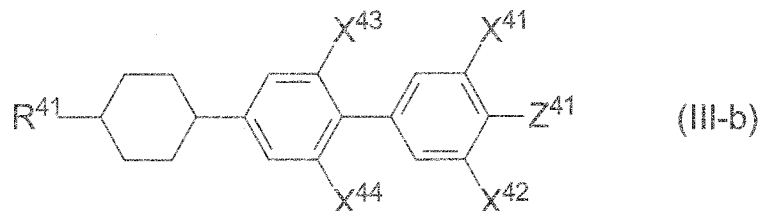

15

20

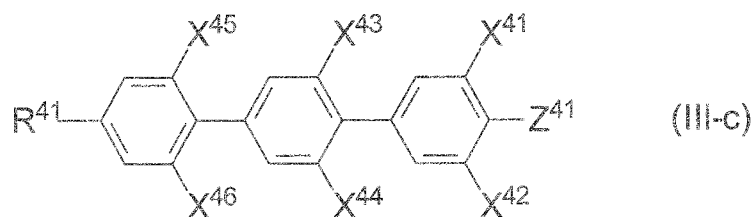

25

30

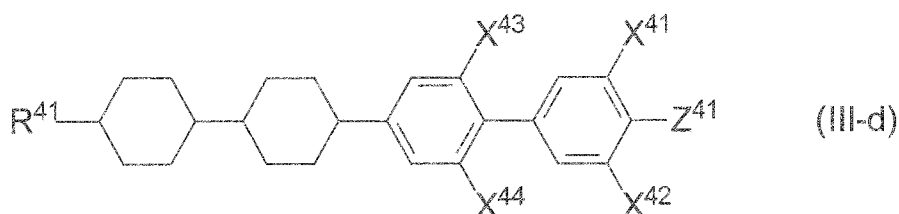

35

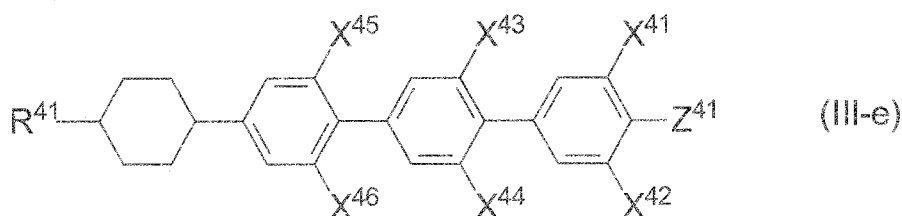

40

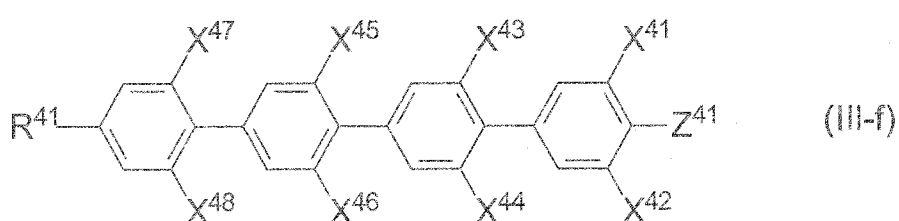

45

(in the formulae, R^{41} represents an alkyl group having 1 to 10 carbon atoms, an alkoxy group, or an alkenyl group or alkenyloxy group having 2 to 10 carbon atoms, X^{41} to X^{48} each independently represent a hydrogen atom or a fluorine atom, and Z^{41} represents a fluorine atoms, a trifluoromethoxy group, or a trifluoromethyl group).

50

10. The liquid crystal display device according to any one of Claims 1 to 9, wherein the liquid crystal composition layer includes a polymer produced by polymerizing a liquid crystal composition containing at least one polymerizable compound.

55

11. The liquid crystal display device according to any one of Claims 1 to 10, wherein the liquid crystal composition layer contains a difunctional monomer represented by general formula (V),

[Chem. 5]

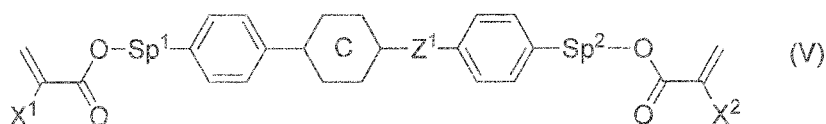

10 (in the formula, X¹ and X² each independently represent a hydrogen atom or a methyl groups,
 Sp¹ and Sp² each independently represent a single bond, an alkyene group having 1 to 8 carbon atoms, or -O-(CH₂)_s-
 (wherein s represents an integer of 2 to 7, and an oxygen atom is bonded to an (aromatic ring), Z¹ represents -OGH₂-
 -CH₂O-, -COO-, -OCO-, -CF₂O-, -OCF₂-, -CH₂CH₂-, -CF₂CF₂-, -CH=CH-COO-, -CH=CH-OCO-, -COO-CH=CH-,
 -OCO-CH=CH-, -COO-CH₂CH₂-, -OCO-CH₂-CH₂-, -CH₂CH₂-COO-, -CH₂CH₂-OCO-, -COO-CH₂-, -OCO-CH₂-,
 -CH₂-COO-, -CH₂-OCO-, -Cy¹=Cy²- (wherein Y¹ and Y² each independently represent a fluorine atom or a hydrogen
 15 atom), -C≡C-, or a single bond, C represents a 1,4-phenylene group, a trans-1,4-cyclohexylene group, or a single
 bond, and any desired hydrogen atom of all 1,4-phenylene groups in the formula may be substituted by a fluorine
 atom).

20

25

30

35

40

45

50

55

FIG. 1

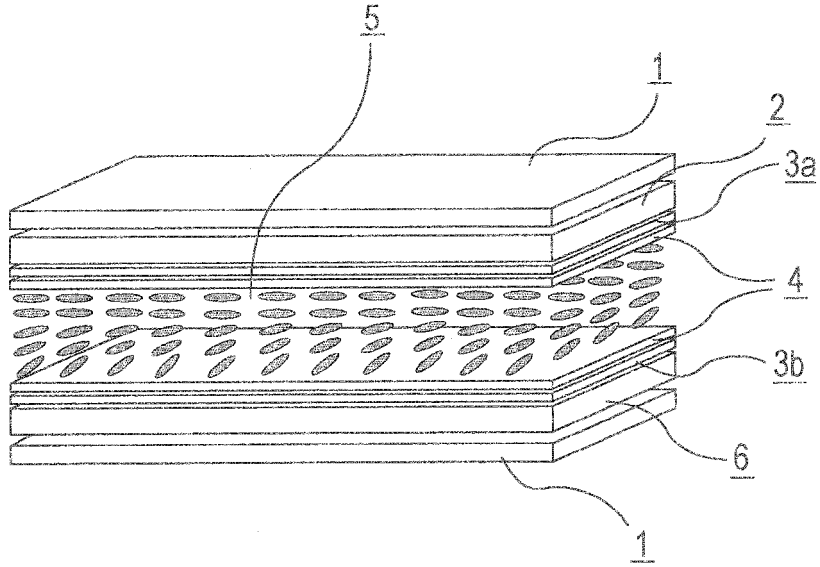
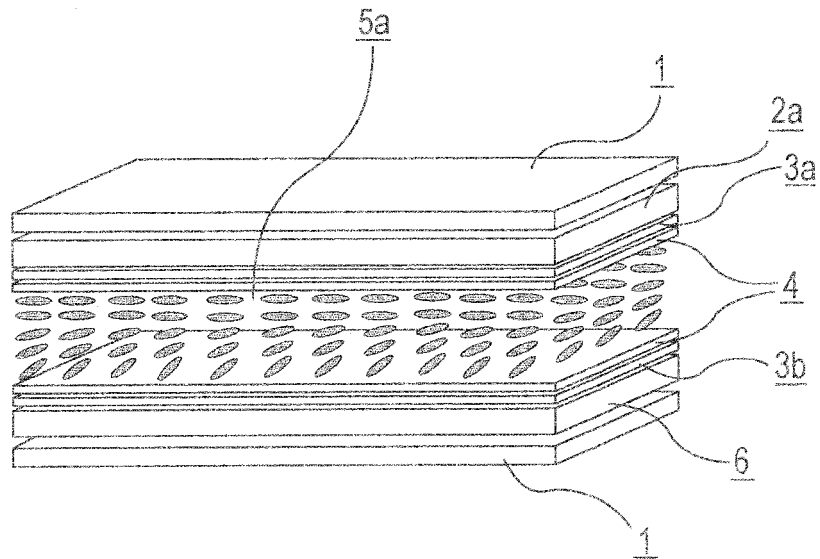

FIG. 2



INTERNATIONAL SEARCH REPORT

International application No.

PCT/JP2013/051079

5	A. CLASSIFICATION OF SUBJECT MATTER G02F1/1335(2006.01)i, C09K19/12(2006.01)i, C09K19/20(2006.01)i, C09K19/30(2006.01)i, C09K19/34(2006.01)i, C09K19/38(2006.01)i, C09K19/54(2006.01)i, G02B5/20(2006.01)i, G02F1/13(2006.01)i According to International Patent Classification (IPC) or to both national classification and IPC	
10	B. FIELDS SEARCHED Minimum documentation searched (classification system followed by classification symbols) G02F1/1335, C09K19/12, C09K19/20, C09K19/30, C09K19/34, C09K19/38, C09K19/54, G02B5/20, G02F1/13	
15	Documentation searched other than minimum documentation to the extent that such documents are included in the fields searched Jitsuyo Shinan Koho 1922-1996 Jitsuyo Shinan Toroku Koho 1996-2013 Kokai Jitsuyo Shinan Koho 1971-2013 Toroku Jitsuyo Shinan Koho 1994-2013	
20	Electronic data base consulted during the international search (name of data base and, where practicable, search terms used)	
25	C. DOCUMENTS CONSIDERED TO BE RELEVANT	
30	Category*	Citation of document, with indication, where appropriate, of the relevant passages
35	A	JP 2000-192040 A (Toshiba Corp.), 11 July 2000 (11.07.2000), entire text (Family: none)
40	A	WO 2010/095506 A1 (Chisso Corp.), 26 August 2010 (26.08.2010), example 23 & TW 201035067 A
45	A	JP 2011-141356 A (Toppan Printing Co., Ltd.), 21 July 2011 (21.07.2011), entire text (Family: none)
50	<input checked="" type="checkbox"/> Further documents are listed in the continuation of Box C. <input type="checkbox"/> See patent family annex.	
55	* Special categories of cited documents: "A" document defining the general state of the art which is not considered to be of particular relevance "E" earlier application or patent but published on or after the international filing date "L" document which may throw doubts on priority claim(s) or which is cited to establish the publication date of another citation or other special reason (as specified) "O" document referring to an oral disclosure, use, exhibition or other means "P" document published prior to the international filing date but later than the priority date claimed	"I" later document published after the international filing date or priority date and not in conflict with the application but cited to understand the principle or theory underlying the invention "X" document of particular relevance; the claimed invention cannot be considered novel or cannot be considered to involve an inventive step when the document is taken alone "Y" document of particular relevance; the claimed invention cannot be considered to involve an inventive step when the document is combined with one or more other such documents, such combination being obvious to a person skilled in the art "&" document member of the same patent family
	Date of the actual completion of the international search 22 February, 2013 (22.02.13)	Date of mailing of the international search report 05 March, 2013 (05.03.13)
	Name and mailing address of the ISA/ Japanese Patent Office	Authorized officer
	Facsimile No.	Telephone No.

INTERNATIONAL SEARCH REPORT

International application No.
PCT/JP2013/051079

5
10
15
20
25
30
35
40
45
50
55

C (Continuation). DOCUMENTS CONSIDERED TO BE RELEVANT		
Category*	Citation of document, with indication, where appropriate, of the relevant passages	Relevant to claim No.
A	JP 2010-189560 A (Toppan Printing Co., Ltd.), 02 September 2010 (02.09.2010), entire text (Family: none)	1-11
A	JP 2006-317602 A (Fujifilm Corp.), 24 November 2006 (24.11.2006), entire text & US 2006/0257763 A1 & KR 10-2006-0116751 A	1-11

Form PCT/ISA/210 (continuation of second sheet) (July 2009)

REFERENCES CITED IN THE DESCRIPTION

This list of references cited by the applicant is for the reader's convenience only. It does not form part of the European patent document. Even though great care has been taken in compiling the references, errors or omissions cannot be excluded and the EPO disclaims all liability in this regard.

Patent documents cited in the description

- JP 2000019321 A [0010]
- JP 2009109542 A [0010]
- JP 2000192040 A [0010]

专利名称(译)	液晶显示装置		
公开(公告)号	EP2916167A1	公开(公告)日	2015-09-09
申请号	EP2013748256	申请日	2013-01-21
[标]申请(专利权)人(译)	大日本油墨化学工业株式会社		
申请(专利权)人(译)	DIC株式会社		
当前申请(专利权)人(译)	DIC株式会社		
[标]发明人	KURIYAMA TAKESHI KAWAMURA JOUJI FUNAKURA SEIJI SHIMADA KATSUNORI		
发明人	KURIYAMA TAKESHI KAWAMURA JOUJI FUNAKURA SEIJI SHIMADA KATSUNORI		
IPC分类号	G02F1/1335 C09K19/12 C09K19/20 C09K19/30 C09K19/34 C09K19/38 C09K19/54 G02B5/20 G02F1/13 C09K19/04 G02F1/00 G02F1/137		
CPC分类号	C09K19/20 C09K19/3066 C09K2019/0448 C09K2019/0466 C09K2019/122 C09K2019/123 C09K2019/124 C09K2019/3004 C09K2019/301 C09K2019/3016 C09K2019/3025 C09K2019/3422 G02B5/20 G02F1/0045 G02F1/137 G02F1/133512 G02F1/133514		
其他公开文献	EP2916167B1 EP2916167A4		
外部链接	Espacenet		

摘要(译)

本发明涉及使用特定液晶组合物的液晶显示装置和包含特定染料和/或颜料的滤色器。本发明提供一种液晶显示装置，其能够防止液晶层的电压保持率 (VHR) 的降低和离子密度 (ID) 的增加，并且解决了诸如白点，取向不均匀等显示缺陷的问题，图像残留等。本发明的液晶显示装置的特征在于防止液晶层的电压保持率 (VHR) 降低和离子密度 (ID) 的增加，并且抑制诸如图像残留的显示缺陷的发生，以及因此，对于用于有源矩阵驱动的IPS模式或FES模式液晶显示装置特别有用，并且可以应用于液晶电视，监视器，蜂窝电话，智能电话等液晶显示装置。电话等。

FIG. 2

